

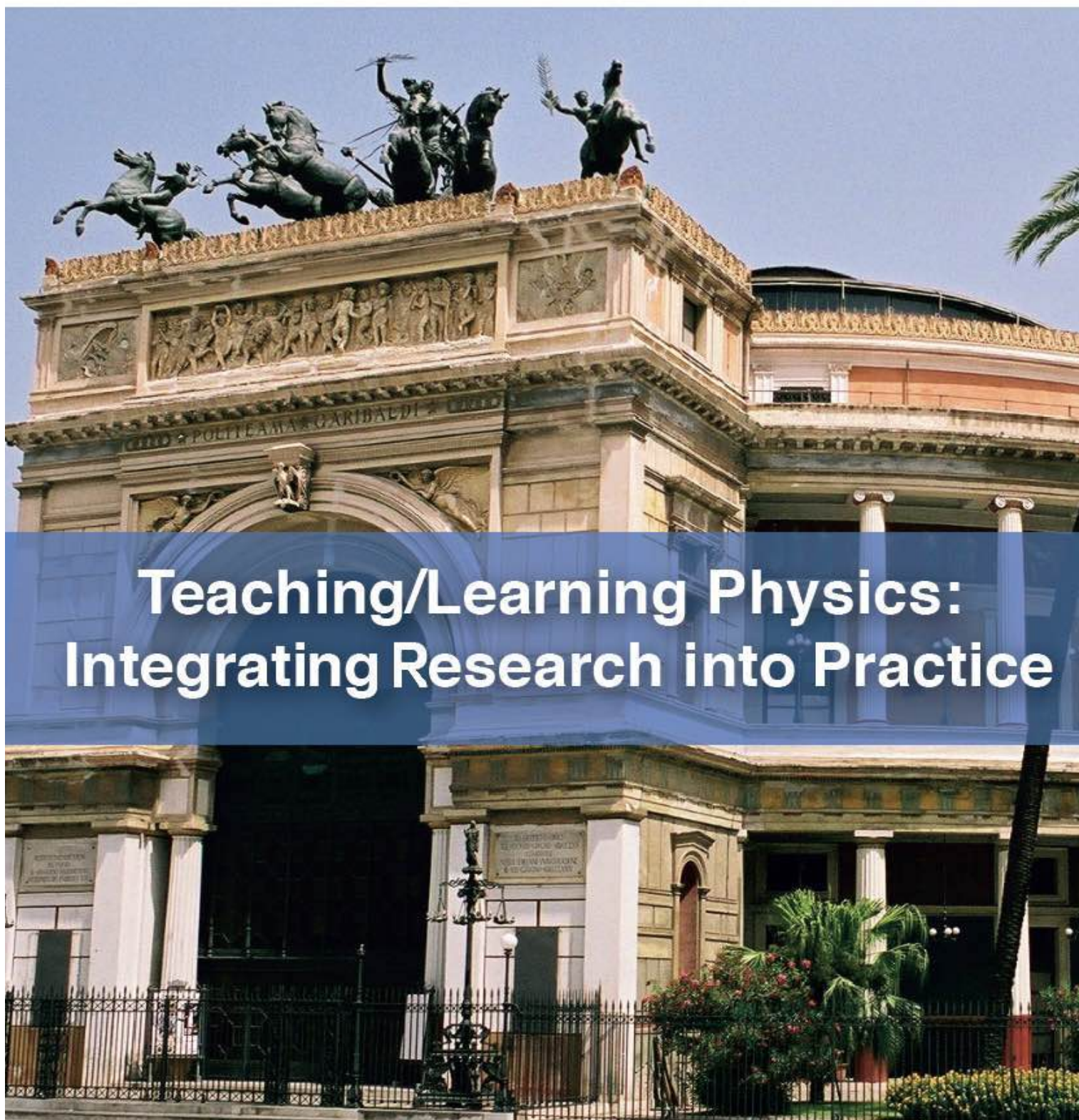

MPTL
Multimedia in Physics
Teaching and Learning



UNIVERSITA'
DEGLI STUDI
DI PALERMO



Teaching/Learning Physics: Integrating Research into Practice

**PROCEEDINGS OF THE
GIREP - MPTL 2014 INTERNATIONAL CONFERENCE**



Dipartimento di
Fisica e Chimica

EDITORS
C. Fazio and R.M. Sperandeo Mineo



MPTL
Multimedia in Physics
Teaching and Learning



TEACHING/LEARNING PHYSICS: INTEGRATING RESEARCH INTO PRACTICE

EDITORS

Claudio Fazio and Rosa Maria Sperandeo Mineo



Dipartimento di Fisica e Chimica

Teaching/Learning Physics: Integrating Research into Practice

Proceedings of the GIREP-MPTL 2014 International Conference
held in Palermo, Italy, July 7 - 12, 2014

Organized by:

Groupe Internationale sur l'Enseignement de la Physique (GIREP)
Multimedia in Physics Teaching and Learning (MPTL)

With the support of:

International Union for Pure and Applied Physics (IUPAP)
European Physical Society - Physics Education Division



MPTL
Multimedia in Physics
Teaching and Learning



UNIVERSITÀ
DEGLI STUDI
DI PALERMO



European Physical
Society
Physics Education
Division



Dipartimento di Fisica e Chimica

The papers included in this volume are a selection of the contribution presented at the Conference. Each paper was reviewed by at least two anonymous referees expert in the field of Physics Education and/or History, Philosophy of Science, Multimedia and ICTs in Physics Education.

© Copyright Università degli Studi di Palermo

First edition: 30th June 2015

Dipartimento di Fisica e Chimica, Università degli Studi di Palermo, Palermo (Italy)

ISBN: 978-88-907460-7-9

GIREP/MPTL 2014 International Conference Committees

Scientific Advisory Committee

Rosa Maria Sperandeo-Mineo, Università di Palermo, Italy

Luisa Cifarelli, Vice-President of EPS (European Physical Society) and President of SIF (Società Italiana di Fisica)

Costas P. Constantinou, University of Cyprus, Cyprus

Wolfgang Christian, Davidson College, USA

Leos Dvorak, Faculty of Mathematics and Physics, Charles University in Prague, Czech Republic

Ton Ellermejer, The Foundation Centre for Microcomputer Applications (CMA), Amsterdam, The Netherlands

Francisco Esquembre, Universidad de Murcia, Spain

Claudio Fazio, Università di Palermo, Italy

Raimund Girwidz, University of Ludwigsburg, Germany

Tomasz Greczyo, University of Wroclaw, Poland

Claudia Haagen-Schuetzenhoefer, Austrian Educational Competence Centre, University of Vienna, Austria

Robert Lambourne, The Open University, UK

Ian Lawrence, Institute of Physics, United Kingdom

Bruce Mason, University of Oklahoma, USA.

Marisa Michelini, Università di Udine, Italy

Eduardo Montero, Escuela Superior Politécnica del Litoral, (Ecuador)

Cesar Eduardo Mora Ley, Instituto Politécnico Nacional, Mexico

Hideo Nitta, Tokyo Gakugei University, JAPAN

Wim Peeters, DKO vzw (work) and PONTOn vzw (ceo), Belgium

Mauricio Pietrocola, School of Education, University of São Paulo, Brazil

Gorazd Planinsic, University of Ljubljana, Slovenia

Mehmet Fatih Taşar, Gazi Üniversitesi, Turkey

Dean Zollmann, Kansas State University, USA

Program Committee

Francisco Esquembre, President of MPTL;

Marisa Michelini, President of GIREP.

Rosa Maria Sperandeo Mineo, Chair of the Conference, Università di Palermo, Italy

Claudio Fazio, Chair of the Local Organizing Committee, Università di Palermo, Italy

Local Organizing Committee

Claudio Fazio, Università di Palermo, Italy

Rosa Maria Sperandeo-Mineo, Università di Palermo, Italy

Benedetto di Paola, Università di Palermo, Italy

Onofrio Rosario Battaglia, Università di Palermo, Italy

Nicola Pizzolato, Università di Palermo, Italy

Giovanni Tarantino, Miur, Italy

Antonia Giangalanti, Miur, Italy

Table of contents

Preface	1
Rosa Maria Sperandeo-Mineo and Claudio Fazio	
1. General Talk Papers	
CONSIDERING PHYSICS KNOWLEDGE AS A CULTURE. AN APPROACH TO PHYSICS	5
CURRICULUM MATCHING INTERESTS AND NEEDS OF CONTEMPORARY LEARNERS Igal Galili	
HOW CAN THE LEARNING OF PHYSICS SUPPORT THE CONSTRUCTION OF STUDENTS'	19
PERSONAL IDENTITIES? Olivia Levrini	
RESEARCH-BASED INTERACTIVE SIMULATIONS TO SUPPORT QUANTUM MECHANICS	29
LEARNING AND TEACHING Antje Kohnle	
SUPPORTING TEACHERS USE AND ASSESSMENT OF INQUIRY BASED SCIENCE EDUCATION	41
IN CLASSROOM PRACTICE Eilish Mccloughlin, Odilla Finlayson	
POTENTIALLY MEANINGFUL TEACHING UNITS (PMTUS) IN PHYSICS EDUCATION	47
Marco Antonio Moreira	
THINKING THE CONTENT FOR PHYSICS EDUCATION RESEARCH AND PRACTICE	61
Laurence Viennot	
2. Physics Teaching/Learning at Primary Level and Teacher Education	
TEACHING ABOUT ENERGY USING COOPERATIVE LEARNING: AN IMPLEMENTATION	83
AND ITS EVALUATION IN A TEACHER TRAINING DEGREE Arantza Rico	
EARLY CHILDHOOD SCIENCE EDUCATION IN AN INFORMAL LEARNING ENVIRONMENT.....	91
Enrica Giordano, Sabrina Rossi	
USING VIDEOS AND VIDEO EDITING SOFTWARE WITH PRE-SERVICE TEACHERS	99
FOR OUR MODERN PRIMARY SCIENCE CLASSROOMS Maeve Liston	
METHODS BASED ON NON-FORMAL-LEARNING AND EMOTION-BASED LEARNING	109
FOR TEACHING PHYSICS IN PRIMARY AND LOWER SECONDARY SCHOOLS Silvia Merlino, Rosaria Evangelista, Carlo Mantovani	
THE PERSISTENCE OF THE ALTERNATIVE CONCEPTIONS: THE CASE OF THE UNIPOLAR	117
MODEL Abdeljalil Métioui, Louis Trudel	
THE ROLE OF SCIENTIFIC MUSEUMS IN PHYSICS AND ASTRONOMY EDUCATION COURSES	129
FOR PRE-SERVICE PRIMARY SCHOOL TEACHERS Ornella Pantano, Sofia Talas, Valeria Zanini	
THE EDUCATION OF PRE-SERVICE PRIMARY SCHOOL TEACHERS FOR TEACHING PHYSICS	137
AS PART OF THE SCIENCE CURRICULUM IN SLOVENIA Jerneja Pavlin, Mojca Čepič	
3. Physics Teaching and Learning at Secondary Level	
PROBABILITY AND AMOUNT OF DATA	149
Corrado E. Agnes	
FROM NAÏVE TO SCIENTIFIC UNDERSTANDING OF MOTION AND ITS CAUSES	157
Alessandro Ascari, Federico Corni, Gabriele Ceroni, Hans U. Fuchs	
HIGH SCHOOL STUDENTS FACE THE MAGNETIC VECTOR POTENTIAL: SOME RELAPSES	165
IN THEIR LEARNING AND TIPS FOR TEACHERS DEALING WITH ELECTROMAGNETISM Sara R. Barbieri, Marco Giliberti	
RESPONSIBLE RESEARCH AND INNOVATION IN SCIENCE EDUCATION: THE IRRESISTIBLE	175
PROJECT Eugenio Bertozzi, Claudio Fazio, Michele Antonio Floriano, Olivia Levrini, Roberta Maniaci, Barbara Pecori, Margherita Venturi, Jan Apotheker	

WORKSHOP: TIPS AND TRICKS TO MAKE TRADITIONAL LABORATORY MORE MINDS-ON.....	183
AND INQUIRY Ed van den Berg	
PLAYING WITH (SUPER)HYDROPHOBICITY: AN INTERDISCIPLINARY EXPERIMENTAL.....	193
SEQUENCE ON PHYSICAL PROPERTIES OF WATER Assunta Bonanno, Giacomo Bozzo, Federica Napoli, Peppino Sapia	
EXPLAINING PHENOMENA SCIENTIFICALLY AND IDENTIFYING SCIENTIFIC ISSUES IN	201
PHYSICS EDUCATION: SOME INTERESTING OBSERVATIONS OF THE HIGH-PERFORMING ECONOMIES IN PISA 2006 Kwok-cheung Cheung	
A DYNAMICAL MODEL FOR THE ROLLING CYLINDER	209
Michele D'Anna	
AN ALTERNATIVE APPROACH TO THE BOLTZMANN DISTRIBUTION THROUGH THE	217
CHEMICAL POTENTIAL Michele D'Anna, Georg Job	
IMPLEMENTATION OF A PROPOSAL TO TEACH QUANTUM MECHANICS CONCEPTS	225
FROM FEYNMAN'S MULTIPLE PATHS APPLIED TO THE LIGHT María De Los Angeles Fanaro, María Rita Otero, Mariana Elgue	
SECONDARY STUDENTS' VIEWS ABOUT SCIENTIFIC INQUIRY	233
Silvia Galano, Alessandro Zappia, Luigi Smaldone, Italo Testa	
DEVELOPMENT OF TEACHING MATERIALS: A COURSE FOR GEOMETRICAL OPTICS	241
FOR LOWER SECONDARY STUDENTS Claudia Haagen, Martin Hopf	
SIMPLE EXPERIMENTS SUPPORTING CONCEPTUAL UNDERSTANDING OF BODY COLOUR	249
Claudia Haagen	
A SUPERFICIAL TEXTBOOK PRESENTATION OF THE GENEVA LAKE EXPERIMENT FOR	257
MEASURING SOUND SPEED IN WATER: STUDENTS' CONSIDERATIONS OF COHERENCE BETWEEN TEXTUAL AND VISUAL INFORMATION Zalkida Hadzibegovic, Josip Slisko	
ON THE VERDICT OF THE GERMAN PHYSICAL SOCIETY AGAINST THE <i>KARLSRUHE</i>	267
<i>PHYSICS COURSE</i> – A CHRONICLE OF EVENTS Friedrich Herrmann, Michael Pohlig	
THERMOLAB - SIMULATING THERMAL PROCESSES BY SIMULATING GIBBS ENSEMBLES	275
Oliver Frisius, Friedrich Herrmann, Michael Pohlig,	
HOW SECONDARY SCHOOL STUDENTS CONCEPTUALIZE INFRARED RADIATION - MATTER	281
INTERACTION? FINDINGS FROM A RESEARCH STUDY AND IMPLICATIONS FOR AN INSTRUCTIONAL DESIGN María Isabel Hernández, Raquel Ríos, Roser Pintó	
IS IT DIFFICULT TO MOTIVATE OUR STUDENTS TO STUDY PHYSICS?	289
Renata Holubova	
STUDENTS' MISCONCEPTIONS REGARDING EVERYDAY THERMAL PHENOMENA	297
Petr Káčovský	
A PLATFORM TO SUPPORT CO ₂ EMISSIONS MAPPING ON THE AEGEAN SEA ISLANDS	305
Barbara Kasselouri, Harry Kambezidis, Alexis Kaselouris, Dimitrios Zevgolis	
PHYSICS TEACHERS' INVENTIONS FAIR – CONFERENCE AND SOURCE OF TEACHING IDEAS	319
Zdeňka Koupilová, Leoš Dvořák	
HIGH SCHOOL STUDENTS' MISCONCEPTIONS IN ELECTRICITY AND MAGNETISM	323
AND SOME EXPERIMENTS THAT CAN HELP TO REDUCE THEM Vera Koudelkova, Leos Dvorak	
KINEMATICS CONCEPTS AT DIFFERENT REPRESENTATION LEVELS – A MUTUAL	329
INFORMATION APPROACH Clemens Wagner, Andreas Lichtenberger, Andreas Vaterlaus	
GUIDING STUDENTS TO COMBINE PARTIAL LAWS OF ENERGY CONSERVATION	339
Paul S. W. M. Logman, Wolter H. Kaper and Ton L. Ellermeijer	
A NEW PHYSICS CURRICULUM FOR A VOCATIONAL SCHOOL	347
Vera Montalbano, Roberto Benedetti, Emilio Mariotti	
TEACHING THE BASIC CONCEPTS OF THE SPECIAL RELATIVITY IN THE SECONDARY	355
SCHOOL IN THE FRAMEWORK OF THE THEORY OF CONCEPTUAL FIELDS OF VERGNAUD	

Maria Rita Otero, Marcelo Arlego, Fabiana Prodanoff	
TEACHERS' VIEWS ABOUT THE IMPLEMENTATION OF AN INTEGRATED SCIENCE CURRICULUM	367
Valeria Poggi, Italo Testa, Cristina Miceli	
VACUUM: ITS MEANING AND ITS EFFECTS THROUGHOUT EXPERIMENTAL ACTIVITIES	373
Marta Rinaudo, Daniela Marocchi, Antonio Amoroso	
DETERMINATION OF THE EARTH RADIUS BY MEASURING THE ANGULAR HEIGHT OF THE SUN ABOVE HORIZON	379
Alexander Kaplinsky, Konstantin Rogozin, Alexey Sorokin, Darya Shakhvorostova, Alexander Wolf	
IMPLEMENTATION OF PEER INSTRUCTION IN CZECH SCHOOLS	383
Jana Šestáková	
HOW DOES EPISTEMOLOGICAL KNOWLEDGE ON MODELLING INFLUENCE STUDENTS' ENGAGEMENT IN THE ISSUE OF CLIMATE CHANGE?	387
Giulia Tasquier	
AN OPEN INQUIRY RESEARCH-BASED TEACHING-LEARNING SEQUENCE ABOUT THE CAUSE OF SEASONS	399
Italo Testa, Gianni Busarello, Silvio Leccia, Emanuella Puddu, Arturo Colantonio	
IMPACT OF A DISCUSSION METHOD ON HIGH SCHOOL STUDENTS' UNDERSTANDING OF KINEMATICAL CONCEPTS	407
Louis Trudel, Abdeljalil Métioui	
4. Physics Teaching and Learning at University Level	
THE BRACED STRING, DISPERSION AND POLARIZATION	421
Sergej Faletič	
HOW CLOSE CAN WE GET WAVES TO WAVEFUNCTIONS, INCLUDING POTENTIAL?	429
Sergej Faletič	
HOW CAN FUTURE EUROPEAN PHYSICS STUDIES LEAD TO INNOVATIVE COMPETENCES AND STIMULATE ENTREPRENEURIAL BEHAVIOUR?	437
Hendrik Ferdinande	
INVESTIGATING PHYSICS TEACHING AND LEARNING AT UNIVERSITY	443
Jenaro Guisasola, Mieke De Cock, Stephen Kanim, Lana Ivanjek, Kristina Zuza, Laurens Bollen, Paul Van Kampen	
VIDEO ANALYSIS BASED TASKS IN PHYSICS	453
Peter Hockicko, Katarína Pažická	
IMPROVING STUDENTS' UNDERSTANDING BY USING ONGOING EDUCATION RESEARCH TO REFINE ACTIVE LEARNING ACTIVITIES IN A FIRST-YEAR ELECTRONICS COURSE	461
Alexander P. Mazzolini, Scott A. Daniel	
TEACHING ELECTROSTATICS THROUGH PROJECT-BASED LEARNING	469
Carlos Collazos, Cesar Mora, Ricardo Otero, Jaime Isaza	
MULTIPLE BOUNCES OF DIFFERENT MATERIAL BALLS IN FREE FALL	477
Armando C. Perez Guerrero Noyola, Fernando Yañez Barona	
AN INQUIRY-BASED APPROACH TO THE FRANCK-HERTZ EXPERIMENT	485
Dominique Persano Adorno, Nicola Pizzolato	
PHYSICAL MODELLING: A DIFFERENT APPROACH TO TEACH NON-PHYSICS MAJORS	493
Estela M. Puente Leos, Marcos Ley Koo	
THE NATURE OF STUDENTS' REASONING PROCESSES IN TASKS INVOLVING THE CONCEPT OF ANGULAR ACCELERATION	499
Graham Rankin	
ACTIVE LEARNING IN OPTICS: A WORKSHOP	503
David R. Sokoloff	
EVALUATION FOR UNDERGRADUATE PROGRAMS: THE CASE OF THE BS APPLIED PHYSICS IN THE UNIVERSITY OF SAN CARLOS	515
Cherile Obate- Yap, Enriqueta D. Reston	
INVESTIGATING STUDENT IDEAS ON THE CONNECTION BETWEEN FORMAL STRUCTURES AND CONCEPTUAL ASPECTS IN QUANTUM MECHANICS	523
Giacomo Zuccarini, Marisa Michelini	
5. ICT and Multi-Media in Physics Education	
OPERATING SYSTEM INDEPENDENT PHYSICS SIMULATIONS	533
Oswaldo Aquines, Hector Gonzalez, Pablo Perez	

INTERACTIVE WHITEBOARD (IWB) AND CLASSROOM RESPONSE SYSTEM (CRS):	539
HOW CAN TEACHERS USE THESE RESOURCES? Assunta Bonanno, Giacomo Bozzo, Federica Napoli, Peppino Sapia	
THE USES OF INTERACTIVE WHITEBOARD IN A SCIENCE LABORATORY	551
Giacomo Bozzo, Carme Grimalt-Alvaro, Víctor López	
PREPARING PRE-SERVICE TEACHERS TO INTEGRATE TECHNOLOGY INTO INQUIRY-BASED SCIENCE EDUCATION: THREE CASE STUDIES IN THE NETHERLANDS	559
Trinh-Ba Tran, Ed van den Berg, Ton Ellermeijer, Jos Beishuizen	
LEARNING ASSESSMENT ABOUT THE MOON'S SYNCHRONOUS ROTATION MEDIATED COMPUTATIONAL RESOURCE	575
Adriano L. Fagundes, Tatiana da Silva, Marta Feijó Barroso	
USING TECHNOLOGY TO PROVIDE AN INTERACTIVE LEARNING EXPERIENCE	583
Kyle Forinash, Raymond Wisman	
USE YOUR HEAD - IN FOOTBALL AND IN PHYSICS EDUCATION	591
Angela Fösel, Leopold Mathelitsch, Sigrid Thaller, Jens Wagner	
FORMATION OF KEY COMPETENCIES THROUGH INFORMATION AND COMMUNICATION TECHNOLOGY	601
Tomasz Greczylo, Ewa Dębowska	
COMPARING METHODS OF MEASUREMENT OF FRICTION WITH SIMPLE EQUIPMENT AND WITH DATA-LOGGERS	609
Kamila Hrabovská, Libor Koníček, Libuše Švecová, Karla Barčová	
IMPLEMENTATION OF AN IN-SERVICE COURSE ON INTEGRATION OF ICT INTO INQUIRY BASED SCIENCE EDUCATION: A CASE STUDY IN SLOVAKIA	617
Zuzana Ješková, Trinh-Ba Tran, Marián Kireš and Ton Ellermeijer	
iMOBILE PHYSICS: A RESEARCH AND DEVELOPMENT PROJECT FOR TEACHING AND LEARNING WITH SMARTPHONES AND TABLET PCS AS MOBILE EXPERIMENTAL TOOLS	629
Pascal Klein, Jochen Kuhn, Andreas Müller	
WHAT IS LIGHT? FROM OPTICS TO QUANTUM PHYSICS THROUGH THE SUM OVER PATHS APPROACH	639
Massimiliano Malgieri, Pasquale Onorato, Anna De Ambrosis	
REPORT AND RECOMMENDATIONS ON MULTIMEDIA MATERIALS FOR TEACHING AND LEARNING QUANTUM PHYSICS	647
Bruce Mason, Ewa Dębowska, Tanwa Arpornthip, Raimund Girwidz, Tomasz Greczylo, Antje Kohnle, Trevor Melder, Marisa Michelini, Lorenzo Santi, Jorge Silva	
CHAOTIC BEHAVIOUR OF ZEEMAN MACHINES AT INTRODUCTORY COURSE OF MECHANICS	657
Péter Nagy, Péter Tasnádi	
ASSESSMENT OF STUDENT CONSTRUCTED MODELS ON TOPICS RELEVANT TO HEAT AND TEMPERATURE SYSTEMS	667
Christiana Th. Nicolaou, Bert Bredeweg, Constantinos P. Constantinou, Jochem Liem	
ROLLING MOTION: EXPERIMENTS AND SIMULATIONS FOCUSING ON SLIDING FRICTION FORCES	675
Pasquale Onorato, Massimiliano Malgieri, Anna De Ambrosis	
TEACHING OPTICS WITH A VIRTUAL MACH-ZEHNDER INTERFEROMETER: AN ANALYSIS OF A COLLABORATIVE LEARNING ACTIVITY	683
Alexsandro Pereira de Pereira, Fernanda Ostermann	
USING LEARNING MANAGEMENT SYSTEM TO INTEGRATE PHYSICS COURSES WITH ONLINE ACTIVITIES: A CASE STUDY	691
Edlira Prenjasi, Shpresa Ahmetaga	
DESIGN, TRAINING EXERCISES AND FEEDBACK IN AN ONLINE LEARNING ENVIRONMENT ABOUT ELECTRONS IN ELECTRIC AND MAGNETIC FIELDS	697
Stefan Richtberg, Raimund Girwidz	
REMOTE AND VIRTUAL LABORATORIES AS PART OF ONLINE COURSES	705
Konstantin Rogozin, František Lustig, Sergey Kuznetsov, Denis Yanyshhev, Pavel Brom, Maxim Kiryasov, Alexey Ovcharov	
ON-LINE COURSEWORK FOR STUDENTS OF OPTICS	711
Konstantin Rogozin, Sergey Kuznetsov, Irina Rogozina, Denis Yanyshhev, Vesselina Dimitrova, Nadezhda Isaeva, Ekaterina Sorokina	
DESIGNING AN EDUCATIONAL METHODOLOGY TO TEACHING THERMAL EQUILIBRIUM USING ICT	719
Rubén Sánchez Sánchez	

THE PHOTOELECTRIC EFFECT AND STUDY OF THE DIFFRACTION OF LIGHT: TWO NEW EXPERIMENTS IN UNILABS VIRTUAL AND REMOTE LABORATORIES NETWORK Juan P. Sánchez, Jacobo Sáenz, Luis de la Torre, Carmen Carreras, Manuel Yuste, Rubén Heradio , Sebastián Dormido	727
TRAINING AND ASSESSMENT OF EXPERIMENTAL COMPETENCIES FROM A DISTANCE: OPTICAL SPECTROMETRY VIA THE INTERNET Lars-Jochen Thoms, Raimund Girwidz	733
PERFORMANCE TASK USING VIDEO ANALYSIS AND MODELLING TO PROMOTE K12 EIGHT PRACTICES OF SCIENCE Loo Kang Wee, Tze Kwang Leong	743
6. In-service and Pre-service Teacher Education	
PROJECT BASED LEARNING FOR TEACHER EDUCATION IN BRAZIL’S STATE WITH THE LOWEST LITERACY RATE Marcos H. Abreu de Oliveira, Mara F. Parisoto, Robert Fischer	753
THE EUROPEAN TEMI PROJECT INVOLVES ITALIAN TEACHERS: FIRST OUTCOMES Sara R. Barbieri, Marina Carpineti, Marco Giliberti	759
INTERACTIVE METHODOLOGIES IN PHYSICS TEACHER TRAINING OF IN A CONTEXT OF CURRICULUM INNOVATION: THE PEER INSTRUCTION METHOD Marcelo A. Barros and Marina V. Barros	767
HOW EXPERIMENTAL RESOURCES IN PHYSICS TEACHING FACILITATE CONCEPTUAL LEARNING? Carlos Buitrago, Maria M. Andrés	775
INERTIAL AND NON-INERTIAL FRAMES: WITH PIECES OF PAPER AND IN AN ACTIVE WAY Leos Dvorak	783
“ELIXIR FOR SCHOOLS” – A NEW INITIATIVE SUPPORTING CZECH PHYSICS TEACHERS Irena Dvorakova, Leos Dvorak	791
EFFECTS OF GENDER AND TEACHING PRACTICE IN AN OUT-OF-SCHOOL LEARNING LAB ON ACADEMIC SELF-CONCEPT OF PRE-SERVICE PHYSICS TEACHERS Markus Elsholz, Susan Fried, Thomas Trefzger	795
REVISITING DERIVATIVES IN PHYSICS WITH PRE-SERVICE PHYSICS TEACHERS IN K-12 CLASSES Olga Gioka	803
IN-SERVICE AND PRE-SERVICE TEACHER EDUCATION IN IBSE – THE ESTABLISH APPROACH Zuzana Ješková, Marián Kireš, Eilish McLoughlin, Odilla Finlayson, Christina Ottander, Margareta Ekborg	811
THE INFLUENCE OF MATHEMATICAL REPRESENTATIONS ON STUDENTS’ CONCEPTUALIZATIONS OF THE ELECTROSTATIC FIELD Ricardo Karam, Terhi Mäntylä	819
UNDERSTANDING AND EXPLAINING EQUATIONS FOR PHYSICS TEACHING Ricardo Karam, Olaf Krey	827
INVESTIGATION OF A REFLECTIVE PEDAGOGY TO ENCOURAGE PRE-SERVICE PHYSICS TEACHERS TO EXPLORE ARGUMENTATION AS AN AID TO CONCEPTUAL UNDERSTANDING Greg Lancaster, Rebecca Cooper	835
TOWARDS A PCK OF PHYSICS AND MATHEMATICS INTERPLAY Yaron Lehavi, Esther Bagno, Bat-Sheva Eylon, Roni Mualem, Gesche Pospiech, Ulrike Böhm, Olaf Krey, Ricardo Karam	843
RESEARCH BASED ACTIVITIES IN TEACHER PROFESSIONAL DEVELOPMENT ON OPTICS Marisa Michelini, Alberto Stefanel	853
EXPLORING SLIDING FRICTION: AN INQUIRY-BASED EXPERIENCE FOR PRE-SERVICE SCIENCE TEACHERS Vera Montalbano	863
WAVE-PARTICLE COMPLEMENTARITY: TEACHING QUANTUM PHYSICS WITH A VIRTUAL MACH-ZEHNDER INTERFEROMETER Jader da Silva Neto, Cláudio José H. Cavalcanti, Fernanda Ostermann	871
THE PROFILES APPROACH TO TEACHING AND LEARNING PHYSICS IN SLOVENIA Jerneja Pavlin, Iztok Devetak	879
THE ROLE OF MATHEMATICS FOR PHYSICS TEACHING AND UNDERSTANDING Gesche Pospiech, BatSheva Eylon, Esther Bagno, Yaron Lehavi, Marie-Annette Geyer	889
SCIENCE TEACHERS’ TRANSFORMATIONS WHEN IMPLEMENTING INQUIRY-BASED TEACHING-LEARNING SEQUENCES	897

Alessandro Zappia, Silvia Galano, Luigi Smaldone, Italo Testa

TEACHER AND PROFESSIONAL DEVELOPMENT IN IBSE AND ASSESSMENT	907
Marián Kireš, Zuzana Ješková, Eilish McLoughlin, Odilla Finlayson, Margareta Ekborg, Christina Ottander	

7. Physics Teaching and Learning in Informal Settings

DEVELOPMENT OF STUDENTS' INTEREST IN PARTICLE PHYSICS AS EFFECT OF PARTICIPATING IN A MASTERCLASS	915
Kerstin Gedigk, Gesche Pospiech	
"GOOD VIBRATIONS" - A WORKSHOP ON OSCILLATIONS AND NORMAL MODES	923
Sara R. Barbieri, Marina Carpineti, Marco Giliberti, Enrico Rigon, Marco Stellato, Marina Tamborini	
CHAOS THEORY AND ITS MANIFESTATIONS: AN INFORMAL EDUCATIONAL ACTIVITY TO EXPLAIN CHAOS TO STUDENTS	931
Valeria Greco, Salvatore Spagnolo	
MULTIMEDIA SOFTWARE "ARCHIMEDES AND HIS WORK": A DEEPENING PATH IN THE ARKIMEDEION MUSEUM OF SIRACUSA	937
Silvia Merlino, Marco Bianucci, Carlo Mantovani, Roberto Fieschi	
PHYSICS COMPETITIONS FOR LEARNERS OF PRIMARY SCHOOLS IN SLOVENIA	949
Barbara Rovšek, Robert Repnik	
A SINGING WINE GLASS AS AN INSTRUMENT FOR TEACHING ACOUSTICS	955
José A. Zárate Colin, Marisol Rodríguez Arcos, Karina Ramos Musalem, Estela M. Puente Leos, Marcos Ley Koo	
INFORMAL TEACHING OF PHYSICS AT A HUNGARIAN SCIENCE CENTER	965
Péter Mészáros	

8. History and Philosophy of Science in Physics Education

RECASTING PARTICLE PHYSICS BY ENTANGLING PHYSICS, HISTORY AND PHILOSOPHY	973
Eugenio Bertozzi, Olivia Levrini	
THE DISCOVERY OF X-RAYS DIFFRACTION: FROM CRYSTALS TO DNA. A CASE-STUDY TO PROMOTE UNDERSTANDING OF THE NATURE OF SCIENCE AND OF ITS INTERDISCIPLINARY CHARACTER	979
Francesco Guerra, Matteo Leone, Nadia Robotti	
A TEACHING PROPOSAL ON ELECTROSTATICS BASED ON THE HISTORY OF SCIENCE THROUGH THE READING OF HISTORICAL TEXTS AND ARGUMENTATIVE DISCUSSIONS	987
Marina Castells, Aikaterini Konstantinidou, Josep Maria Cerveró	
NATURE OF SCIENCE IN SCIENCE EDUCATION: FROM 'TENETS' TO 'THEMES'	999
Andre F. Pinto Martins, Jim Ryder	

9. Pedagogical Methods and Strategies

THE ROLE OF TEACHING SCAFFOLDING IN INQUIRY-BASED LEARNING OF BLACK-BOXED ELECTRIC CIRCUITS	1011
Wheijen Chang	
INTEGRATED STEM IN SECONDARY EDUCATION: A CASE STUDY	1021
Jolien De Meester, Heidi Knipprath, Jan Thielemans, Mieke De Cock, Greet Langie, Wim Dehaene	
A QUANTITATIVE METHOD TO ANALYSE AN OPEN ANSWER QUESTIONNAIRE: A CASE STUDY ABOUT THE BOLTZMANN FACTOR	1029
Onofrio R. Battaglia, Benedetto Di Paola	
AN AMERICAN INSTRUCTOR IN AN UPPER-LEVEL ITALIAN PHYSICS CLASS	1041
Gerald Feldman	
TEACHER CHANGE IN IMPLEMENTING A RESEARCH DEVELOPED REPRESENTATION CONSTRUCTION PEDAGOGY	1049
Peter Hubber, Gail Chittleborough	
LABORATORY ACTIVITIES AND THE PERCEPTION OF STUDENTS	1059
Daniela Marocchi, Marina Serio	
MATHEMATICAL MODEL OF THE DIDACTIC STRUCTURE OF PHYSICS KNOWLEDGE EMBODIED IN PHYSICS TEXTBOOKS	1071
Eizo Ohno	
INFLUENCE OF PEER METHOD AND IBSE IN SCIENCE COMPETENCE IN CHILEAN SECONDARY STUDENTS	1079
Nataly Rodríguez, Iván Sánchez, Ivo Fustos	
SOLVING OF QUANTITATIVE PHYSICS TASKS – SELECTED SUB-SKILLS AND HOW TO	1087

TEACH THEM

Marie Snetinova, Zdeňka Koupilová,

USING ROLE-PLAYING GAME IN A VIRTUAL LEARNING ENVIRONMENT FOR A NEW 1095
APPROACH TO PHYSICS CLASSROOM LESSONS

Annalisa Terracina, Massimo Mecella

MOTIONS OF A METAL BALL IN THREE IMAGINARY TUNNELS THROUGH THE EARTH:..... 1105
A PILOT STUDY IN BOSNIA AND HERZEGOVINA ON COHERENCE OF STUDENTS'

GRAVITATION AND INERTIA CONCEPTIONS

Jasmina Baluković, Josip Sliško

List of Referees 1115**Author Index** 1117

Preface

The GIREP-MPTL International conference on Teaching/Learning Physics: Integrating Research into Practice [GIREP-MPTL 2014] was held . from 7 to 12 July 2014, at the University of Palermo, Italy.

The conference has been organised by the Groupe International de Recherche sur l'Enseignement de la Physique [GIREP] and the Multimedia in Physics Teaching and Learning [MPTL] group and it has been sponsored by the International Commission on Physics Education [ICPE] – Commission 14 of the International Union for Pure and Applied Physics [IUPAP], the European Physical Society – Physics Education Division [EPS-PED], the Latin American Physics Education Network [LAPEN] and the Società Italiana di Fisica [SIF].

The theme of the conference, **Teaching/Learning Physics: Integrating Research into Practice**, underlines aspects of great relevance in contemporary science education. In fact, during the last few years, evidence based Physics Education Research provided results concerning the ways and strategies to improve student conceptual understanding, interest in Physics, epistemological awareness and insights for the construction of a scientific citizenship. However, Physics teaching practice seems resistant to adopting adapting these findings to their own situation and new research based curricula find difficulty in affirming and spread, both at school and university levels. The conference offered an opportunity for in-depth discussions of this apparently wide-spread tension in order to find ways to do better.

The purpose of the GIREP-MPTL 2014 was to bring together people working in physics education research and in physics education at schools from all over the world to allow them to share research results and exchange their experience.

About 300 teachers, educators, and researchers, from all continents and 45 countries have attended the Conference contributing with 177 oral presentations, 15 workshops, 11 symposia, and around 60 poster presentations, together with 11 keynote addresses (general talks).

After the conference, 147 papers have been submitted for the GIREP-MPTL 2014 International Conference proceedings. Each paper has been reviewed by at least two reviewers, from countries that are different to those of the authors and on the basis of criteria described on the Conference web site. Papers were subsequently revised by authors according to reviewers' comments and the accepted papers are reported in this book, divided in 8 Sections on the basis of the keywords suggested by authors. The other book section (actually, the first one) contains the papers that six of the keynote talkers sent for publication in this Proceedings Book.

We would like to thank all the authors that contributed with their papers to the realization of this book and all the referees that with their criticism helped authors to improve the quality of the papers.

Palermo, 30th June 2015

Rosa Maria Sperandeo Mineo and Claudio Fazio

Chapter 1
General Talk Papers

Considering Physics Knowledge as a Culture – an Approach to Physics Curriculum Matching Interests and Needs of Contemporary Learners

Igal Galili

The Amos de Shalit Science Teaching Centre, The Hebrew University of Jerusalem

There are very few, if at all, new things in this world. Therefore, the agenda of a person is to find a new, fresh interpretation of those familiar.

Giorgio Morandi
Italian Artist

Abstract

Common physics curricula present the subject of physics as a scientific discipline - clearly and univocally. This presentation usually leaves in shade several aspects of this knowledge which are especially important for the contemporary culture in a wider sense. Those emphasize plurality and polyphonic discourse taking place in physics as a living body producing knowledge in the process of construction, debate and refutation in the ongoing practice and across the time. In structuring physics curriculum we suggest to emphasize its basing on a few fundamental theories which comprise a conceptual dialogue, specify the difference among them as well as their commonality (family resemblance). This goal can be reached through structuring the contents of each theory according to triadic affiliation: nucleus, body, and periphery. Such approach may frame the inclusion of history and philosophy of science in school curriculum and create cultural content knowledge (CCK) in students. CCK creates appropriate space for meaningful learning leaving the options of preferable interest to its certain area by different individuals, provides options of emphasis on particular area of knowledge, yet within the big picture of physics. We have applied this approach within the European project HIPST in creating special units – historical excurses presenting conceptual discourses regarding several physics concepts that we illustrate here.

Keywords

CCK-cultural content knowledge in physics education, physics discourse, structure of physics curriculum, discipline-culture, nucleus, body knowledge, periphery knowledge, cognitive preference of the learners, structure of scientific revolution, structure of individual conceptual change.

1. Introduction

Back in the 60s, Josef Schwab, one of the founders of science education research, determined this area as comprised of four thematic commonplaces: subject matter, teachers, students, and environment (Schwab, 1962). Establishing motivation of this study, we first observe and very briefly mention characteristic features of the obtained understanding of each of the commonplaces.

With regard to the *commonplace of students*, it is common to adopt the perspective of constructivism which states the establishment of individual knowledge in the extended developmental process of interaction of the personal cognition with various external factors (e.g. Duit & Treagust, 2003). It is understood that in the process of learning students ubiquitously produce alternative to scientific conceptions either totally different and/or of hybrid nature (e.g. Vosniadou & Brewer, 1992; Galili et al., 1993). Students are extremely prolific in such conceptions and the studies documenting those are extremely numerous (e.g., Viennot, 1979; Driver & Erikson, 1983; Driver et al. 1985; Duit, 2003). Constructivist teaching suggests taking into account this *plurality* by addressing it this or other way in instruction in order to overcome them as barriers to the understanding of scientific contents.

With regard to the *commonplace of teachers*, their ability to address the plurality of different conceptions of students and recognize their cognitive preferences (e.g. Tamir, 1985) establish, in view of Schulman (1986),

a special kind of knowledge required in teaching science – Pedagogical Content Knowledge (PCK).

Teachers serve as *mediators* of the collective, socially possessed knowledge in the complex process of knowledge assimilation. Clearly, this process is much beyond a mere transmission.

With regard to the *commonplace of environment*, the great variety of suggested forms of supporting effective learning is also extremely wide. This veracity reflects the variety of populations, social contexts of learning, curricula and levels of instruction (e.g. Fraser et al. 2014). Introduction of computer tutorials, simulations, intelligent databases caused a flood of variations of changing traditional classroom environment.

So far one may observe significant conceptual variety with respect to each of the three considered commonplaces of science education. This is not what we may say regarding the fourth commonplace, the *commonplace of subject matter*. Normally, the curriculum of physics presents what is called disciplinary curriculum (Tseitlin & Galili, 2005). It usually contains topics, concepts and conceptions unfolding to the learner in a traditional sequence and accompanied with extensive solving of standard problems. In applying this approach, such essential features as structure of physics knowledge, its hierarchy, interrelationship between the components, reduction to a few fundamental theories, concept construction often remain in shade of intensive practicing of physics knowledge application and its utilization in problem solving. In such teaching physics, one of the major epistemological issues – the *conceptual discourse* regarding the construction of physics knowledge, as we possess and consume it now, is not always addressed.

In our study, we considered the way to reveal the conceptual discourse in educational context. We framed this discourse in the triadic structure of knowledge which we previously suggested to represent the relationship among the fundamental theories of physics. Within this framework, we see physics knowledge as a culture (Tseitlin & Galili, 2005), naming such knowledge cultural content knowledge (CCK). We have suggested two ways to accrete such knowledge in educational process. Firstly, we will mention the produced series of historical excursions to the discourse regarding physical concepts, such as motion and weight (Galili, 2011). Secondly, we suggested and tried to apply a summative lecture as a delayed organiser of knowledge, following regular learning (Levrini et al, 2014) as a new format of teaching seeking CCK. In the following, we will briefly present the rationale of the CCK approach and illustrate how it emerges in physics discourse.

2. Physics knowledge as a culture

Physics knowledge is comprised of a few fundamental theories (Heisenberg, 1958; Weizsäcker, 1985; Bunge, 1967). Each such theory establishes an inclusive cluster of numerous elements – principles, concepts, conceptions, models, experiments, explained phenomena, etc., which are coherent with certain conceptual framework and can be represented using dual codification as shown in the diagram of Fig. 1a. It possesses two areas of knowledge elements. The first area – *nucleus* – includes basic principles and the second one – *body* – incorporates numerous applications in the form of elements mentioned above comprising the normal knowledge of the theory. This structure represents a *disciplinary curriculum* which draws on certain theory, such as classical mechanics.

What makes this structure representing a *cultural* knowledge is the adding of the third type of knowledge elements – the *periphery* (Fig. 1b). This area includes conceptions, problems, phenomena which are inconsistent, contradict or unexplained by the considered nucleus. These elements may suggest alternative accounts for the same subjects that were already explained and as such belong to the body. The unsolved problems of the periphery challenge the particular theory, its nucleus. This structure may represent a discipline-culture curriculum which observes the relationship of different physical theories.¹

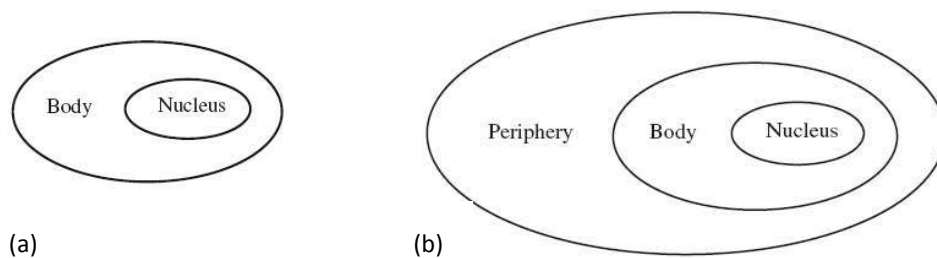

Figure 1. (a) The structure of a fundamental theory or a disciplinary course. (b) The structure representing the cultural knowledge of a theory or a discipline-culture teaching.

¹ The triadic codification was applied by Lakatos in 1978 (to depict Scientific Research Program of a fundamental theory. In that use, however, the meaning of the components (the contents of the areas of the triadic diagram), as well as their labels, will be different.

One, thus, faces a choice in the construction of physics curriculum: disciplinary versus culture-disciplinary. The latter presumes making explicit the basic tenets of each theory in comparison with other possible theoretical accounts. Thus, within the cultural knowledge perspective the classical mechanics is *not* a special case of the relativistic mechanics because the nuclei of both theories are essentially different and contradict each other (time, space, interaction, speed of light, conservation laws, etc.) (Fig. 2). Similarly, one can address the relationship between quantum mechanics and classical mechanics: classical mechanics is *not* a special case of quantum mechanics.

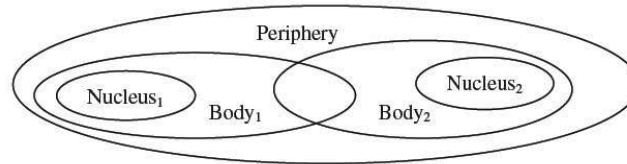

Figure 2. Discipline-culture structure of two fundamental theories.

This perspective refines the meaning of *incommensurability* of different scientific paradigms often ascribed to different scientific paradigms (Kuhn, 1962/1970). The overlaying bodies of knowledge may depict treating the same problem by different approaches and so shows, in a sense, the *commensurability* of different physical theories. At the same time, the nucleus of each theory is in the periphery of the other showing essential contradiction. This approach allows visualizing the polyphony of physical theories in their accounting for the reality by family-like theories. This picture represents the reality of numerous materials produced by research activities of the normal science.

Let me add why this perspective is termed *cultural*. The term culture is frequently used in a very wide span of meaning. This because, speaking generally, it represents all possible products of human society (Tylor, 1920). Other researchers name by culture separate clusters of human products which distinguish among different areas of human activities such as Art, Science, Literature (Hofstede, 1991). Within the culture of science, one may focus on human behaviour in doing science (Latour, 1987) or on the specific perception of science in light of local culture by a specific ethnic group (Aikenhead, 1997, Aikenhead & Jegede, 1999).

There is, however, a different perspective of one considering the *knowledge* of physics itself. One may see that physics knowledge presents a *discourse*, which interprets (beyond describing) reality, is selective in adoption ideas, conceptions, standards of verification and method of inquiry in accounting for the reality, establishes rules and performs experiments. Physics has its values, ethos and ethics. All these imply that the physics knowledge, by itself, presents a culture (Lotman, 2001). Of two possible types of culture – the culture of rules and the culture of texts – physics presents a culture of rules. Our focus in this study, however, is on the content knowledge and the conceptual discourse which makes physics knowledge cultural. So, in our use, culture implies explicit addressing of this discourse.

3. Implications of considering physics as a culture

As mentioned, the cultural content knowledge (CCK) presumes making explicit the conceptual dialogue of science, addressing the conceptual variety in the account for certain subject. One can illustrate this aspect by considering the fragment of a regular school curriculum presenting the "world organization". Usually, it focuses on heliocentric world view as overcoming the geocentric one adopted in the past. Its emergence is often termed Copernican revolution. Within the cultural approach, a teacher would present a picture of the continuous debate from the beginning of physics between the geocentric view – a part of Aristotelean physics – and the alternative views suggested by Pythagoreans prior to Aristotle and by Aristarchus immediately after Aristotle. So placing Aristotle in the nucleus (Fig. 3), one mentions other views of the periphery. One proceeds to the Hellenistic science in which the geocentric theory was essentially strengthened by its fundamental elaboration by Ptolemy in his *Almagest* placed in the body of geocentric theory. In the following the teacher may emphasize the non-stopping contributions developing and correcting the geocentric conception by Muslim scholars (Alhazen and Al-Tusi) and criticizing it during the medieval period, those by Buridan, Oresme and Nicolas of Cusa eventually arriving to the modern time. Then, the hybrid view of Tycho Brahe appeared as a strong challenge of the central idea from the periphery. Finally, the wave of critiques started from Copernicus, Kepler and Galileo caused a breakthrough – radical conceptual change of the Copernican revolution. All the process may be framed and visualized by the exchange of elements between the nucleus and periphery in the triadic structure (Fig. 3).

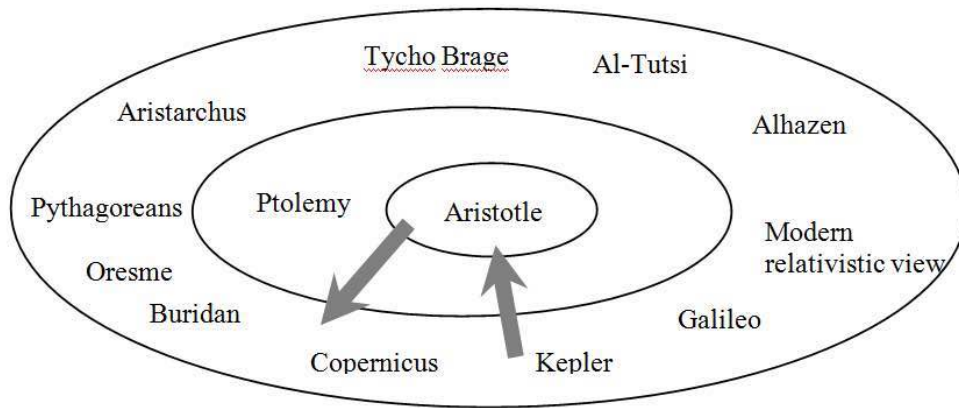

Figure 3. Discipline-culture structure of the geocentric theory of the world order. Arrows show the exchange of knowledge elements between the nucleus and periphery representing the radical conceptual change during the scientific revolution.

The cultural perspective on this subject would include mentioning the more advanced views which upgraded the picture as held in our days and considers by physicists as the correct one. The theory of modern astrophysics left the "helio-centric" perspective in favour of the concept of expanding universe without unique centre, the view that introduces freedom of the choice of an observer depicting the world in his frame of reference.

3.1 Individual conceptual change

The suggested triadic structure can be applied to visualize the individual conceptual change in the process of leaning science. The process of exchange between the nucleus and periphery is the conceptual change. We have depicted the conceptual change in the collective knowledge of science (Fig. 3), but if one put the initial conception of the learner in the nucleus and the physics conception taught – in the periphery, a parallel process emerges with regard to personal knowledge. Moreover, Posner and colleagues (1982) specified the conditions for such change (dissatisfaction with the old knowledge together with plausibility, intelligent and productive nature of the new conception). These conditions apparently imitate the conceptual change in science. This similarity might indicate certain relevance of *recapitulation* as a developmental phenomenon introduced to educational psychology in early twentieth century (Kofka, 1925). One may observe certain similarity of onto- and phylogenies of knowledge, limited but existed. Further use of this similarity for promoting the individual conceptual change could be through involving learning materials involving historical conceptual change in the subject matter taught (Galili & Hazan, 2000b). Whether or not the initial view and the educational goal are similar, the important fact is that the educational conceptual change presents the important change of knowledge status. Using the three world idea of Popper (1978), one may say that the educational conceptual change is, in a way, a transition from the World 2 of individual conceptions to the World 3 of physical theories.

The impact of the social environment on the individual learning is very significant. Vigotsky (1994) stated it as process of enculturation. Following intensive research, we also know much more about the features of individual conceptual change (Vosniadou, 2007; Duit & Treagust, 2003; Limon, 2001). The naïve knowledge is stated to be based on basic self-explanatory patterns of spontaneous reasoning rooted in personal experience (Schemata – in Piaget, 1972; and p-prims – in diSessa, 1993). The context dependent patterns of reasoning were suggested by Minstrell (1992) as facets-of-knowledge. Combining the two levels of context independent with context dependent patterns of reasoning, one may obtain a two – level structure of scheme-facets (e.g. Galili & Lavrik, 1998, Stein & Galili, 2014). The latter included also the impact of teaching. We might then depict the conceptual change of students in science by a diagram showing the consolidation of the knowledge in specific area possessing triadic structure (Fig. 4). I may represent learning in a whole domain (mechanics, optics) or concept (weight, image). Even in the best case of successful learning the original conceptions of students do not disappear but preserved in memory and can reappear when students are challenged with a novel problem (Galili & Bar, 1992). This preservation might be depicted by placing the initial conceptions in the periphery of the resultant knowledge.

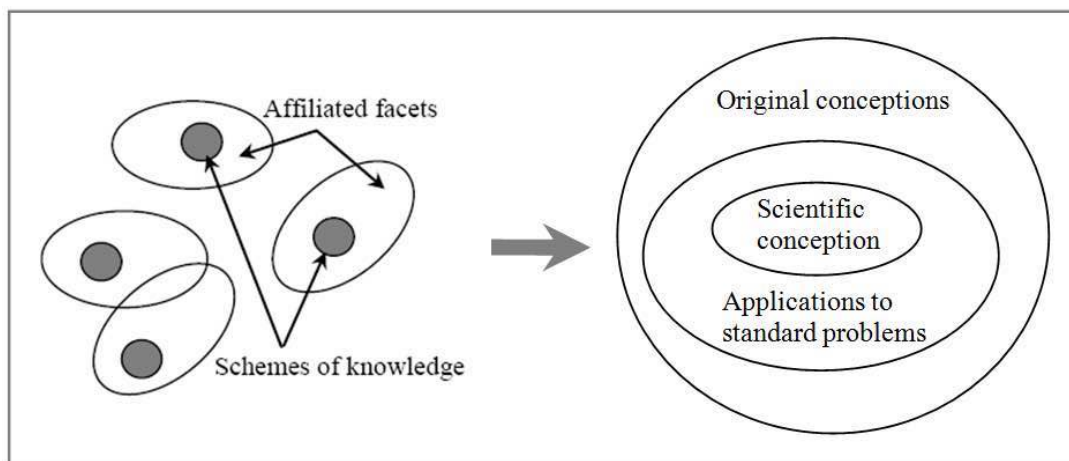

Figure 4. Schematic representation of individual conceptual change in certain domain of physics knowledge. It starts from scheme-facet structure and transfers to triadic structure resulting formal learning.

3.2. Students' cognitive preferences

The triadic structure of knowledge may be applied to refine and classify students' perceptions of physics instruction and attitude to physics. In our empirical study (Levrini et al., 2014), we observed students with various interests towards physics knowledge as might be expressed in Figure 5.

Though one may not ascribe hierarchy to the variety of interests in general sense, we do ascribe importance to the awareness of students' different attitudes to physics instruction in a regular class. Indeed, very often the students who show the skills and interest to the body-knowledge – problem solving, modelling, application of the newly acquired knowledge for practical goals are usually most supported by teachers and different institutions known for their support to students. We may call them "pragmatists" or "practitioners" (Fig. 5). This is in contrast with those who show an interest only to the great design, major laws and principles of physics (the nuclei of physics theories) which empower them to understand conceptual explanations of the natural phenomena, technological and social applications of science. These students – "philosophers" in Fig. 5 – are often perceived as not serious enough learners of physics, rather "dreamers" or "humanitarians". There are still the rest, the students who are interested in the controversial aspects of the learned knowledge, the limited justification of the basic decisions, "why this principles, laws, not other possible ones?" These students might disturb the regular flow of instruction, impede the process of practicing the new knowledge in standard problem solving. Yet, though sometimes annoying and disturbing, it is these students that may produce future researchers and creators of the new knowledge. Therefore, we may call them "revolutionists".

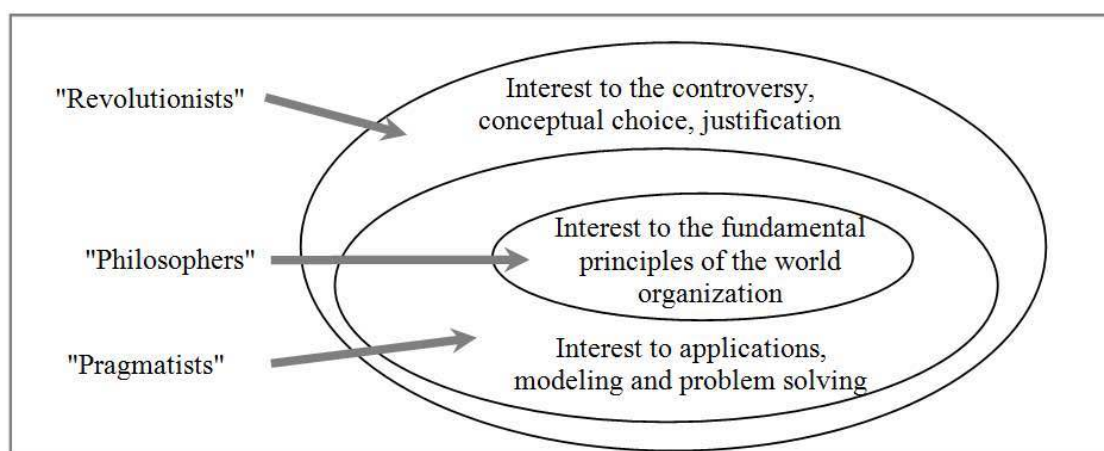

Figure 5. Distribution in individual interests or preferences on behalf of the students.

All together, the existence of this variety among the students' interests in physics denounces and replaces the dichotomy of students (and people in general) stated by C.P. Snow (1961) and known as two-culture vision of society with respect to science: "physicists" and "poets", good and bad students of physics class. This

inference possesses far reaching implications with regard to the learning materials for physics learners. Those materials have to speak at least in three epistemic dimensions. Not less important is the inference of necessity of physics education research to address the students' population in its cognitive variety. Neglecting this reality definitely causes missing fundamental features in physics teaching-learning reality.

Quite in parallel, one may observe similar distribution of interests in the course of history, in the kind of contributions of different physicists to the construction of physics knowledge. The names of those who contributed to the nucleus of the constructed theories (theory of relativity, quantum theory, astrophysics etc.) are usually better known to the wide public. This activity was praised by Karl Popper who emphasised the role of fundamentals in each physical theory (its nucleus).

Other numerous physicists made an extensive contribution by solving great variety of sophisticated problems, explaining phenomena and experiments, producing various devices drawing on the principles of the basic theories. This great body of knowledge was termed "normal knowledge" and it was praised by the philosopher of science Thomas Kuhn (1962/1970) as comprising the majority of activities in physics at each period of history between scientific revolutions.

There were other contribution too. Those included interpretations which were in odds with the particular nucleus and challenged its claims. For example, some physicists suggested alternative to the commonly adopted Copenhagen interpretation (Schrodinger, de-Broglie, Einstein, Bohm). These contributions essentially motivated the growth of understanding and the progress of the quantum theory. It was the debate of Einstein with Bohr (Bohr, 1949/1959) and the suggested experiment by Einstein-Podolsky-Rosen (1935) which was expected to show incompleteness of the quantum theory. It, however, resulted in the discovery of breaking locality in the micro-world, preserving causality despite instantaneous correlation between entangled particles. Paul Feyerabend (1975) – a philosopher of science – emphasized the key role of such elements of knowledge that went against the norm of the reigning paradigm in order to reach revolutionary change in the adopted scientific knowledge. This claim points to the importance of the periphery of knowledge and praised this type of physics activity.

4. The ways of dissemination of CCK

We have developed two channels to implement the approach of providing cultural content knowledge to the students and teachers at high school level of physics instruction. In the following we briefly describe the approach of historical excursions. Another approach of summative lecture (delayed organiser of knowledge) is described in another publication (Levrini et al. 2014).

Historical excursion is special genre of learning material which recovers the conceptual discourse which produced physics knowledge of a particular concept of physics. Such learning unit recovers in major features the synchronic and diachronic debate that took place in physics in the course of history. We call them *excurses* in contrast to other close format used by our colleagues who considered historical *cases*. We have prepared several such excurses (Galili, 2011) and briefly illustrate some of them here.

4.1 Motion

The excursion to the concept of motion included the voices of two basic pre-Newtonian accounts for motion, that by the Hellenic theory of Aristotle and that developed by the Hellenistic and medieval scholars, Hiparchus, Philoponus, Buridan, Oresme, and the scholars of Merton school on Oxford. Their major arguments were depicted in the debate that ultimately brought to the establishment of the Newtonian concept of motion in classical mechanics. The meaning of the new theory was discussed in comparison with other views and the approaches which converged to the Newtonian theory through approach made by Galileo and Descartes. The revived discourse placed to the fore the content of the nucleus of Newtonian revolution: the new understanding of motion as a natural state of natural objects as opposed to the previous understanding as a process objects go through from one state to another. The major change in the nucleus of the new theory of motion was, thus, the replacement of the rest-motion opposition with the rest-uniform motion equivalence (relativity principle of Galileo) (Fig. 6).

The approach of this excursion ascribed a special importance to the First Newton's Law as the most fundamental principle of classical mechanics. This is in contrast to the teaching which does not reserve to it more importance that being only a special case of the second law. It is the latter that is usually in the focus of teaching mechanics at schools. The excursion mentioned how inaccurate translations of the law from Latin

to English performed after Newton caused the impoverishing the deep meaning Newton put to that law² (Galili & Tseitlin, 2003).

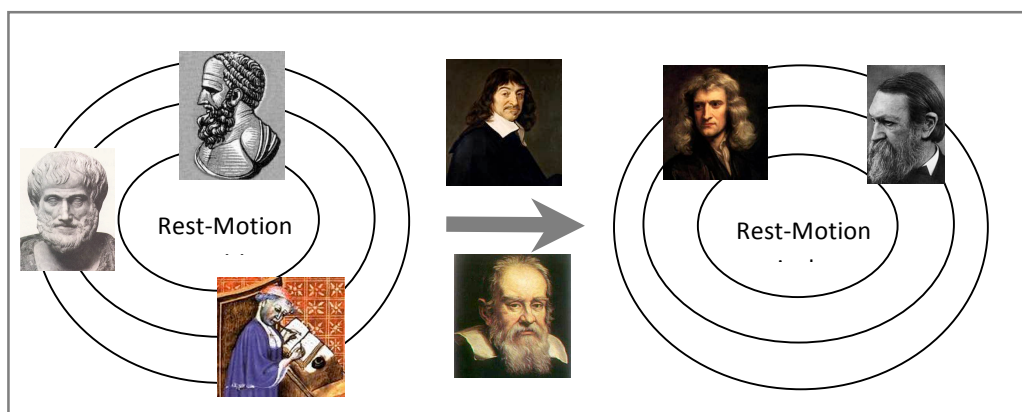

Figure 6. Symbolic representation of the Newtonian revolution with regard to the concept of motion.

The relevance of the historical development of understanding of motion was argued by certain similarity of the historical conceptions to frequently shown students' conceptions (e.g. McCloskey, 1983a,b; Halloun & Hestenes, 1985).

4.2 Weight

We have dedicated a special excursion to the historical discourse regarding the concept of weight. As a matter of fact, this concept, which is a subject of learning through all levels of physics curricula, is taught differently by different teachers in different countries. In the US the textbooks split between the two options. One defines weight as the gravitational force (e.g. Sears & Zemansky, 1982; Young & Friedman, 2012) and the other defines weight as the force causing weighing results (e.g. Hewitt, 2006; Knight, 2013). This dichotomy in weight definition implies different accounts and explanations of physical situations such as weightlessness and so on. The excursion depicted the major steps in the unfolding of conceptual discourse through the history of weight concept (Galili, 2001). In a simplified way this long history could be represented in the diagram of Figure 7.

The two ways to teach weight split the community of physics educators, and textbook authors in each camp continue teaching in the way considered by them to be the correct one ignoring the other view. This is an interesting feature of this situation that no textbook presents both options and compare them. In a sense, this is a "disciplinary" approach to teaching which contrasts with the "cultural" one. The excursion to weight conceptual history tries to bring a discourse to the fore regardless the decision taken. We believe that awareness of the historical discourse, the arguments launched by physicists and philosophers of science together with researches in physics education might change the situation to better for the students who widely hold numerous misconceptions regarding weight and weightlessness. Several studies in physics education reported about these problems of students (Galili & Kaplan, 1996; Galili & Lehavi, 2003; Stein & Galili, 2014).

² The latest translation of Principia by B.C. Cohen and A. Whitman published in 1999 corrected the translation but, of course, could not correct the impact of the previous publications (Newton, 1999).

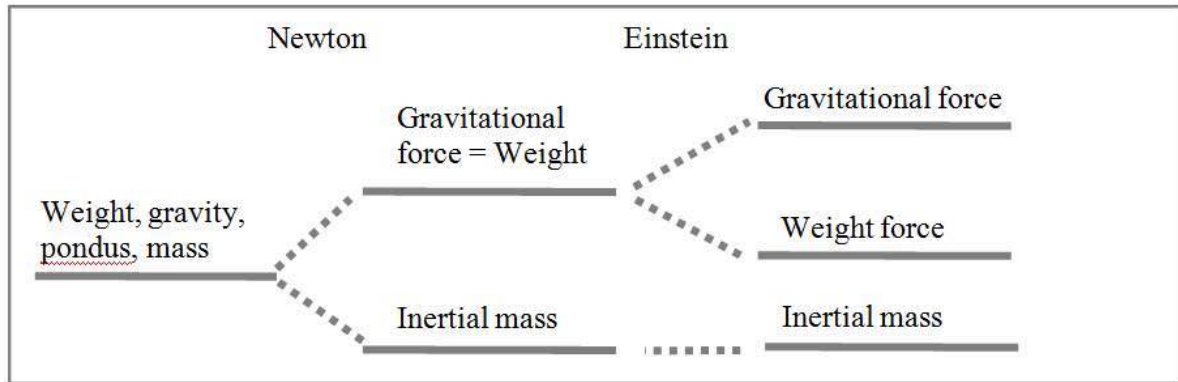

Figure 7. Schematic representation of the development of the concept of weight. A conceptual splitting took place twice: at the establishment of classical mechanics by Newton (Newton, 1687/1999) and at the time when modern relativistic mechanics was introduced by Einstein (Reichenbah, 1927/19580).

4.3 Optical Image

Another excursion addressed the optical image concept. It depicted the major steps of the history of this concept and included several accounts for this phenomenon as were adopted in the course of physics progress. In a regular course, optical image is elaborated within the ray theory of light (geometrical optics). Many studies report about numerous alternative conceptions shown by students with respect to vision, image creation, transfer and observation of images (e.g. Guesne, 1985; Galili & Hazan, 2000a,b). It appears that the history of physics knows practically all of the ideas that contemporary students show as misconceptions and which are debated among scholars at different times and living in different countries. The misconceptions: holistic image transfer to the observer (Atomists in Hellenic Science), Active vision by flux and vision rays (Pythagoreans in Hellenic science, Euclid and Ptolemy in Hellenistic science, Al-Kindi – in Arabic science), the image due to mapping of each point of the object to the point of its image by a single light ray (Alhazen in Arabic Science) (Fig. 8). This discourse spread over the time of more than 2000 years and ultimately produced the account as suggested by Kepler in the 17th century and learned at our schools (Lindberg, 1976). The validity of this parallelism, whether or not one adopts the idea of historical recapitulation, is provided by the constructivist account of learning and the inferences regarding the type of teaching required in order to overcome the misconceptions. Drawing on cognitive resonance between the mental models held by the students and the historical conceptions the historical discourse exposed the argumentation of each of the accounts, not only the correct one. This is considered to be the appropriate way towards establishing by students' cultural content knowledge – CCK – with regard to optical image. Addressing optical image allows frequent involvement of artistic images from history of art and science in the presentation – a feature that possesses additional appealing power for those many our students who are sensitive to visual presentation of scientific statements and especially by means of the artistic images (Galili, 2013).

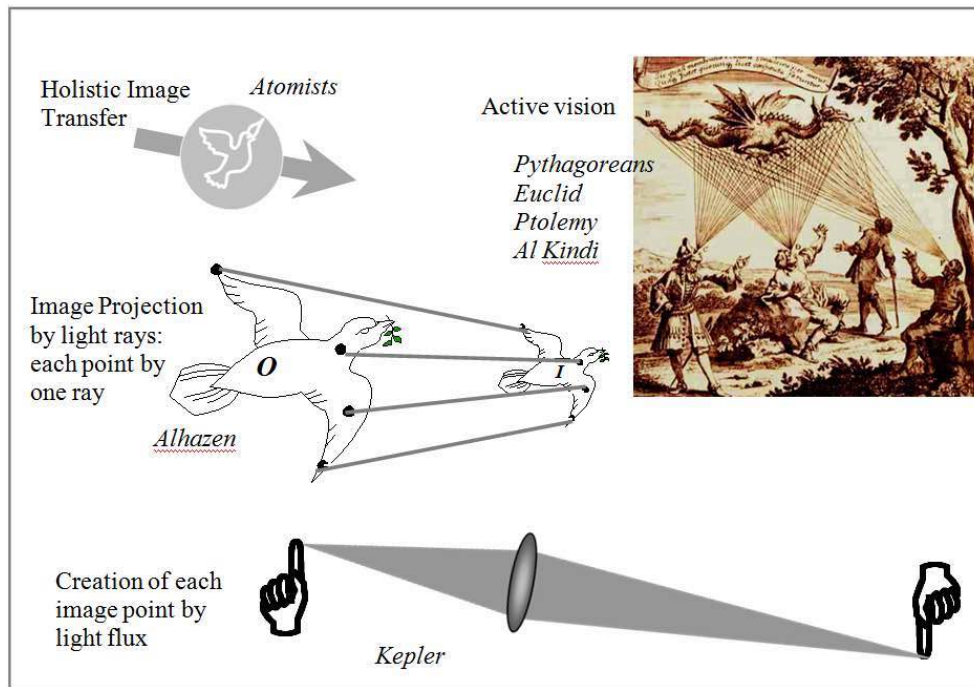

Figure 8. Schematic representation of the major accounts for optical image concept as appeared in the course of history of science.

5. Discussion and concluding remarks

We may now summarise our perspective on physics knowledge as a subject of learning. Cultural knowledge framework provides a big picture of physics required by those who want to get its holistic view and to perceive its ideology. The big structure of physics as comprised of a few fundamental theories provides meaning to the scientific knowledge as a cluster of a *few* different rational accounts for reality arranged in several coherent conceptual systems. Actually, it is this feature that provides an individual with a chance to make sense of myriads of knowledge elements (facts, models, problems, conceptions...). Lacking the big picture often frustrates especially young novices who do not see an end to the new knowledge elements which they continuously try to assimilate, to cover more and more. Dealing solely with modelling – an extremely important tool of physics – they indeed might get an impression of endless work: the more we learn the more we know and the more we can proceed with modelling new situations. It is thus important to point to a different perspective by which physicists do cover the whole body of physics, not in details, but in essence. They know the limits of validity of several fundamental physics theories and know their periphery – the difference between their paradigms and something about the open problems. Even if it might be possible (as physicists believe) to reduce all knowledge to one theory of everything, people will not abandon mechanics, thermodynamics, electrodynamics, quantum theory as separate theories with rather clear areas of applicability. Facing a problem a physicist first of all identifies the theory appropriate to apply and starts to "dig" for the solution by creating and applying appropriate model. So, modelling and models are incorporated in the structure of a fundamental theory as its important content (Fig. 9).

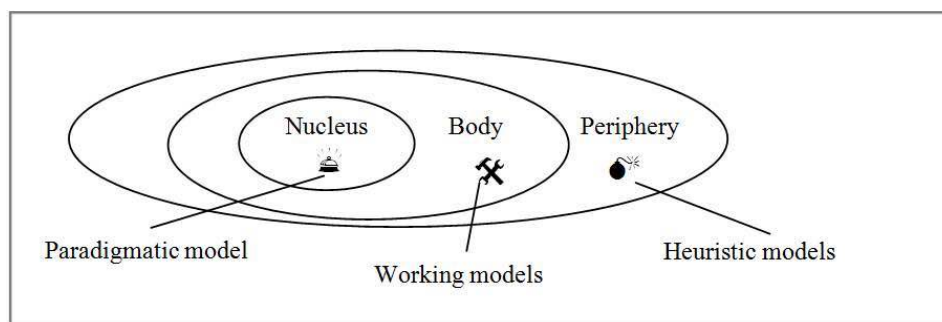

Figure 9. Models may appear in all areas of knowledge structure of the theory. This scheme shows theory-model relationship in terms of culture-discipline structure.

The common reservation against the inclusion of periphery to the scope of physics teaching is that such introduction would bring unnecessary complexity, causing much confusion to students whose knowledge is fragile and immature. Besides the role of periphery as making physics contents interesting, dynamic and adequately representing the real physics (which "should be made simple but not too simple" – Einstein) and besides the claim of relevance of wrong (in contemporary perspective) historical ideas as causing cognitive resonance in the learner who possesses similar to the historical conception (Monk & Osborne, 1997, Galili & Hazan, 2000b), it is important to mention the substantial claim made by educational psychologists (Marton et al, 2004) who insisted on the necessity of creating a *space of learning* which should include the concept to be learned together with its *conceptual variation*. Meaningful learning, within this perspective, presents a process of discerning the goal concept while contrasting it against its alternatives. This way, through continuous comparison, our cognition works. Thus, the periphery plays, it emphasises the essence of the concept to be learned. In a way, it spotlights the "critical details" (Viennot, 2003) of the considered physical concept.

Finally, regarding the role of history and philosophy of science (HPS), we mention that CCK clarifies the rationale of using such knowledge in creating the relevant periphery and required space of learning. One thus arrives to a special perspective within which *two types* of HPS materials may be distinguished. One type includes elements which are correct (verified with type) knowledge. They may include, for example, Archimedes' laws of levers and buoyancy, Eratosthenes' measuring of Earth's radius, and Levenhook's invention of microscope. Using these elements together with stories and anecdotes of social and behaviouristic nature are known as interesting and amusing. At the same time, one cannot ascribe to them being *essential* for the learners of physics.

There are, however, elements of other nature too. They represent the incorrect knowledge of physics, alternative theoretical views and concepts. They might contribute to the periphery of the knowledge we try to mediate to the students. Such are the Aristotelian conceptions of motion or vision, medieval concept of impetus, caloric theory of heat and others. They present building blocks in the process of *educational reconstruction* of the considered subject matter (Duit et al., 2005). In the construction of our excurses these are relevant and essential. Their inclusion would be considered as an important innovation of physics curriculum.

We may conclude with stating that our belief is that cultural representation of physics knowledge reveals to the learners its conceptual meaning better than disciplinary one and as such, it is required especially for the prospective teachers and researchers. This change may lead to strengthening as aspect of *teaching* rather than *instruction* and of *training* – rather than *learning*, an important reward in humanistic perspective. Acquaintance of the learners with the relevant scientific discourse performs their *enculturation* to the culture of physics replacing the low efficient *indoctrination* of the formal knowledge. This aspect seems to us of central importance. The famous semiotician Umberto Eco once *wrote that* "The beauty of the universe is manifested not only in the unity of varieties but also in the variety in the unity". CCK approach applies this perspective to the physics knowledge aiming to replace the enormous *pressure of understanding* exerted on the modern learner of physics with much more preferable *pleasure of understanding*.

References

- Aikenhead, G. S. & Jegede, O. J. (1999). Cross-cultural science education: A cognitive explanation of a cultural phenomenon. *Journal of Research in Science Education*, **36**(3), 267-287.
- Aikenhead, G.S. (1997). Towards a first nations cross-cultural science and technology curriculum. *Science Education*, **81**(2), 217-238.
- Ausubel, D. P. (1968). *Educational psychology: A cognitive view*. Holt, Rinehart and Winston, New York.
- Bohr, N. (1949/1959). Discussion with Einstein on epistemological problems in atomic physics. In P.A. Schilpp (Ed.), *Albert Einstein: philosopher-scientist* (pp 201–241). Harper, New York.
- Bunge, M. (1967). *Foundations of physics*. Springer, New York.
- diSessa, A. (1993). Toward an epistemology of physics. *Cognition & Instruction*, **10**, 105–225.
- Driver, R. & Erickson, G. (1983). Theories-in-Action: Some Theoretical and Empirical Issues in the Study of Students' Conceptual Frameworks in Science. *Studies in Science Education*, **10** (1), 37-60.
- Driver, R. Guesne, E. & Tiberghien A. (Eds.) (1985). *Children's ideas in science*. Open University Press, Milton Keynes, UK.

- Duit, R. & Treagust, D. F. (2003). Conceptual change: A powerful framework for improving science teaching and learning, *International Journal of Science Education*, **25**(6), 671-688.
- Duit, R. (2009). *Bibliography – STCSE Students' and Teachers' Conceptions and Science Education*. On-line: <http://archiv.ipn.uni-kiel.de/stcse/>. Retrieved on July, 20, 2014.
- Duit, R., Gropengießer, H., & Kattmann, U. (2005). Towards science education research that is relevant for improving practice: The model of educational reconstruction. In H.E. Fischer (Ed.), *Developing standards in research on science education* (pp. 1-9). Taylor & Francis, London.
- Einstein A, Podolsky, B, & Rosen N (1935). Can quantum-mechanical description of physical reality be considered complete? *Physical Review*, **47**, 777–780
- Feyerabend, P. (1975). *Against the Method*, Verso, London.
- Fraser, J. M., Timan, A. L., Miller, K., Dowd, J. E., Tucker, L., & Mazur, E. (2014). Teaching and physics education research: Bridging the gap. *Reports on Progress in Physics*, **77**(3), 032401.
- Galili, I. & Bar, V. (1992). Motion implies force. Where to expect vestiges of the misconception? *International Journal of Science Education*, **14** (1), 63-81
- Galili, I. & Hazan, A. (2000a). Learners' knowledge in optics: Interpretation, structure, and analysis, *International Journal in Science Education* **22**(1), 57-88.
- Galili, I. & Hazan, A. (2000b). The influence of historically oriented course on students' content knowledge in optics evaluated by means of facets-schemes analysis. *Physics Education Research, American Journal of Physics*, **68**(7), S3-S15.
- Galili, I. & Hazan, A. (2004). Optics – The theory of light and vision in the broad cultural approach, Jerusalem, Israel: Science Teaching Center, The Hebrew University of Jerusalem.
- Galili, I. & Hazan, A. (2009). *Physical Optics - the theory of light in the broad cultural approach*, Parts II and III (Physical Optics of Waves and the Modern Theory of Light). Science Teaching Center, The Hebrew University of Jerusalem, Jerusalem, Israel.
- Galili, I. & Kaplan, D. (1996). Students operation with the concept of weight. *Science Education*, **80** (4), 457-487
- Galili, I. & Lavrik, V. (1998). Flux concept in learning about light: A critique of the present situation. *Science Education*, **82**, 591-613.
- Galili, I. & Lehavi, Y. (2003). The importance of weightlessness and tides in teaching gravitation. *American Journal of Physics*, **71**(11), 1127-1135.
- Galili, I. & Tseitlin, M. (2003). Newton's first law: text, translations, interpretations, and physics education. *Science and Education*, **12** (1), 45-73
- Galili, I. (2001). Weight versus gravitational force: Historical and educational perspectives. *International Journal of Science Education*, **23**(10), 1073-1093
- Galili, I. (2011). Fisica come cultura nella didattica della fisica. *Giornale di Fisica*, Issue 2, April/June, 89-102.
- Galili, I. (2013). On the Power of Fine Arts Pictorial Imagery in Science Education in Science Education. *Science & Education*, **22**, 1911-1938.
- Galili, I. (2014). Teaching Optics: A Historico-Philosophical Perspective. In M. R. Matthews (Ed.), *International Handbook of Research in History and Philosophy for Science and Mathematics Education* (pp. 97-128). Springer Dordrecht, NL.
- Guesne, E. (1985). Light. In R. Driver, E. Guesne, & A. Tiberghien (Eds.), *Children's ideas in science* (pp. 11-32). Open University Press, Milton Keynes, UK.
- Halloun, I. & Hestenes, D. (1985). Common Sense Concepts about Motion. *American Journal of Physics*, **53**, 1056–1065.
- Heisenberg, W. (1958). *Physics and Philosophy*. Harper, New York.
- Hewitt, P. G. (2006). *Conceptual physics*. Pearson Prentice Hall, Upper Saddle River, NJ.
- Hofstede, G. (1991). *Cultures and organizations: Software of the mind*. McGraw-Hill, London.
- Kepler, J. (1610/2000). *Optics: Paralipomena to Witelo and the Optical Part of Astronomy*. Green Lion Press, Santa Fe, New Mexico.

- Kipnis, N. (1991). *History of the Principle of Interference of Light*. Birkhauser Verlag, Basel.
- Kipnis, N. (1992). *Rediscovering Optics*. Bena Press, Minneapolis.
- Kipnis, N. (1996). The historical-investigative approach to teaching science. *Science & Education*, **5**, 277 - 292.
- Kipnis, N. (1998). A history of science approach to the nature of science: Learning science by rediscovering it. In W.F. McComas (Ed.), *The nature of science in science education* (pp. 177-196). Dordrecht, NL: Kluwer Academic Publisher.
- Kipnis, N. (2010). Scientific errors. *Science & Education*, **10**, 33-49.
- Knight, R. D. (2013). *Physics for scientists and engineers* (3rd ed.). Pearson, Reading, Mass.
- Kofka, K. (1925). *The Growth of Mind* (p. 44). Harcourt, Brace & Co, New York.
- Kuhn, T. (1962/1970). *The Structure of Scientific Revolution*. University of Chicago Press, Chicago.
- Lakatos, I. (1978). *The Methodology of Scientific Research Programs*. Cambridge University Press, Cambridge, UK.
- Landau, L. & Lifshits, E. (1962). *The Course in Theoretical Physics*, Pergamon Press, NL.
- Landau, L.D. & Lifshitz, E.M. (1965). *Quantum Mechanics, Nonrelativistic Theory*, Pergamon Press, Oxford, UK.
- Latour, B. (1987). *Science in Action*. Harvard University Press, Cambridge, MA.
- Levrini, O., Bertozzi, E., Gagliardi, M., Grimellini-Tomasini, N., Pecori, B., Tasquier, G., & Galili, I. (2014). Meeting the Discipline-Culture Framework of Physics Knowledge: An Experiment in Italian Secondary School. *Science & Education*. DOI: 10.1007/s11191-014-9692-z
- Limon, M. (2001). On the Cognitive Conflict as Instructional Strategy for Conceptual Change: A Critical Appraisal. *Learning and Instruction*, **11**, 357–380.
- Lindberg, D.C. (1976). *Theories of vision form Al-Kindi to Kepler*. The University of Chicago Press, Chicago.
- Lotman, Yu. (2001). *Universe of Mind. A Semiotic Theory of Culture*, I.B. Tauris, UK.
- Marton, F. Runesson, U., & Tsui, A. B. M. (2004). The space of learning. In F. Marton, & A. B. M. Tsui (Eds.), *Classroom Discourse and the Space of Learning* (pp. 3-40). Lawrence Erlbaum. Mahwah, New Jersey.
- Matthews, M. (1984). *Science Teaching. The Role of History, Philosophy and Science*. Routledge, New York.
- Matthews, M. (2000). *Time for Science Education*. Kluwer, Dordrecht, NL.
- Matthews, M.R. (1989). A role for history and philosophy of science in science teaching. *Interchange*, **20**, 3-15.
- McCloskey, M. (1983a). Intuitive physics. *Scientific American*, **248**(4), 114-122.
- McCloskey, M. (1983b). Naive Theories of Motion. In D. Genter & A.L. Stevens (Eds.), *Mental models* (pp. 299-324). Erlbaum, Hillsdale, NJ.
- Minstrell, J. (1992). Facets of Students' Knowledge and Relevant Instruction. In Duit, R., Goldberg, F. & Niedderer, H. (Eds.), *Research in Physics Learning: Theoretical Issues and Empirical Studies* (pp. 110–128). IPN, Kiel, Germany.
- Monk, M. & Osborne, J. (1997). Placing the history and philosophy of science on the curriculum: A Model for the development of pedagogy. *Science Education*, **81**(4), 405-424.
- Nersessian, N. (1989). Conceptual Change in Science and in Science Education, *Synthese*, **8**(1), 163-183.
- Newton, I (1999) *Mathematical Principles of Natural Philosophy*, translated by B. Cohen & A. Whitman. University of California Press, Berkeley, CA.
- Newton, I. (1704/1952). *Opticks*. Dover, New York.
- Piaget, J. (1972). *The Child's Conception of Physical Causality*. Littlefield, Adams, Totowa, New Jersey.
- Popper, K.R. (1965). *Conjectures and Refutations: The Growth of Scientific Knowledge*. Harper Torchbooks, New York.

- Popper, K.R. (1978). Three worlds. The Tanner Lecture on Human Values. The University of Michigan. <http://www.tannerlectures.utah.edu/lectures/documents/popper80.pdf>. Retrieved on August 1, 2012.
- Popper, K.R. (1981). *Objective knowledge*, Clarendon Press, Oxford, UK.
- Posner, G., Strike, K., Hewson, P. & Gertzog, W. (1982). Accommodation of a Scientific Concept: Towards a Theory of Conceptual Change. *Science Education*, **66**, 211–227.
- Reichenbach, H. (1927/1958). *The Philosophy of Space and Time*. Dover, New York.
- Schwab, J. (1964). Problems, Topics, and Issues. In Clam, S. (Ed.), *Education and the Structure of Knowledge*. Chicago: Rand McNally.
- Sears, F.W. & Zemansky, M.W. (1882). *University Physics* (pp. 18, 66). Addison Wesley, New York.
- Shapiro, A.E. (1993). *Fits, Passions, and Paroxysms*. Cambridge University Press, Cambridge, UK.
- Shulman, L.S. (1986). Those who understand: Knowledge growth in teaching. *Educational Researcher*, **15**(2), 4- 31.
- Snow, C.P. (1961). *Two Cultures and the Scientific Revolution*. Cambridge University Press, New York.
- Stein, H. & Galili, I. (2014). 'The Impact of Operational Definition of Weight Concept on Students' Understanding of Physical Situations'. *International Journal of Research in Science and Mathematical Education*. DOI: 10.1007/s10763-014-9556-7.
- Tamir, P. (1985). Meta-analysis of cognitive preferences and learning, *Journal of Research in Science Teaching*, **22**(1), 1–17
- Tseitlin, M. & Galili I. (2005). Teaching physics in looking for its self: from a physics-discipline to a physics-culture. *Science & Education*, **14** (3-5), 235-261.
- Tylor, E. (1871/1920). *Primitive culture* (Vol. 1). Putnam, New York
- Viennot, L. (1979). Spontaneous reasoning in elementary dynamics. *European Journal of Science Education*, **1**(2), 205–221.
- Viennot, L. (2003). *Teaching Physics*. Springer, New York.
- Vosniadou, S. (2007). The Conceptual Change Approach and its Re-Framing (pp.1-15). In Vosniadou, S., Baltas A. & Vamvakoussi, X. (Eds.), *Re-Framing the Conceptual Change Approach in Learning and Instruction*, Elsevier, Earli, Amsterdam.
- Vosniadou, S. & Brewer, W.F. (1992). Mental models of the earth: A study of conceptual change in childhood. *Cognitive Psychology*, **24** (4), 535–585.
- Vygotsky, L. (1994). *Thought and Language*, MIT Press, Cambridge, MA.
- Young, H. D., & Freedman, R. A. (2012). *University Physics* (pp. 406, 421-422). Pearson, Addison Wesley, New York.
- Weizsacker, C. F. (1985/2006). *The structure of physics*. Springer, Dordrecht, NL.

Affiliation and address information

Igal Galili
The Amos de Shalit Science Teaching Centre
Faculty of Mathematics and Natural Sciences
The Hebrew University of Jerusalem
Givat Ram Campus
91904 Jerusalem, Israel
e-mail: igal.galili@mail.huji.ac.il

How Can the Learning of Physics Support the Construction of Students' Personal Identities?

Olivia Levrini

Department of Physics and Astronomy, Alma Mater Studiorum – University of Bologna, Italy

Abstract

In public perception, the humanities (history, philosophy, art, and literature) still have a privileged role as subjects that can encourage students to develop their personal orientations and aesthetics. In contrast, physics and mathematics are school subjects that have been shown to put off many young people because of the strong image of authority they still maintain in which there is no place for arguments and personal views. In this paper, the following questions are considered: How can the learning of physics content support students in constructing their personal identities? Conversely, How does the search for a personal self-narrative influence students' approaches to learning disciplinary content?

The extended body of work I describe in this paper is based on a design experience on the topic of thermodynamics in a secondary school physics class (grade 12). This case is notable for investigating the previous questions since the students in this class came to appropriate, or make their own, the discourse of thermodynamics. That is, their conceptual understanding and disciplinary engagement were accomplished by a reflexive process of populating scientific discourse with personal intentions, purposes and tastes. With respect to this case, I will discuss possible connections between the specific model of educational reconstruction we used to design the teaching materials and the type of productive learning that sits at the nexus of disciplinary engagement and identity and that we have come to refer to as "appropriation."

Keywords

Identity, Model of Education Reconstruction, Appropriation, Thermodynamics.

1. Introduction: Identity in STEM education

In this paper I will discuss a problematic issue that the study of science at school should, in my opinion, deal with: how can the teaching of sciences result in making learning a transformative personal experience that actually impacts the construction of individuals' personal identities? Usually it is the humanities (history, philosophy, art, and literature) that have the privileged role as pre-university subjects to encourage students to develop their identities, personal orientations and aesthetics. But, what about physics? Can learning physics support students in the construction of their personal identities? If so, how?

The word identity will be used here in the sense that Sfard and Prusak and the sociologist Giddens (1991) give to the term: identities *as* stories, as opposed to something given and that can be expressed *through* stories; identities as narratives of the self which are constantly created and re-created in dialogical interactions between people (Sfard & Prusak 2009).

Students' identity has been widely investigated within STEM education, (e.g., Gee, 2001; Sfard & Prusak, 2005) and, in particular, there is significant interest in how students' identities affect learning (e.g. Sfard & Prusak, 2005; Nasir & Hand, 2008; Cobb, Gresalfi & Hodge, 2009). However, the inverse question of how learning disciplinary content affects the formation of students' identities is still little explored. It is this direction – from the learning of a scientific discipline to the construction of identity – that attracted our attention.

In order to provide a contribution towards answering the top level questions mentioned at the beginning, the paper will refer to an extended design experience on the topic of thermodynamics in a secondary school physics class (grade 12), where students came to use the words of physics for developing their own identity, i.e., their narratives of self. The design, implementation and analysis of the experience was a real collaborative effort and involved the teacher, Paola Fantini, and other scholars in math and physics education, Mariana Levin, Barbara Pecori, Giulia Tasquier. For all of us what came out in the class was somehow a surprise, a phenomenon that we did not foresee in advance and it required a long process of

analysis to be interpreted. In order to present what happened, I need to describe briefly the research framework and the context of the experience.

This paper is articulated in three parts: a) the background on the study, including the research framework, the teaching materials on thermodynamics, and the class context; b) the description of *what* happened in the class and in what sense we can say that physics had an impact on the development of students' identities, and c) a first-level interpretation aimed at understanding *why* that happened.

2. Background on the study: the research framework, the teaching materials and the context of implementation

This study has a long story. It started in late '90's when the research group in Physics Education in Bologna, led by Nella Grimellini Tomasini, and several other Italian research groups devoted their research attention to the design of teaching materials relevant from a *cultural*¹ point of view (e.g., Busini & Tarsitani 1996; Grimellini Tomasini, 2004; Levrini, Bertozzi, Gagliardi, Grimellini-Tomasini, Pecori, Tasquier & Galili, 2014a). To anticipate the end of the story, years of collaboration with teachers and plenty of classroom implementations led us to observe that something very special regularly happened in the classes. A "special atmosphere" was perceivable. Thus, in the last ten years, our research work of instructional design was progressively enriched by methodological concerns regarding the issue of how to capture what we perceive "in the air" and to explain it theoretically.

As I already mentioned, the story of the instructional design started in late '90. Early milestones were the Model of Educational Reconstruction (MER) that we encountered in the 1996 NARST conference, and an UNESCO report about "The reasons of students' disaffection toward Science & Technology" that Sjøberg presented in the 2001 ESERA conference.

MER became a pillar of our theoretical framework mainly for the image of physics that it gave back within Science Education. Also in this research domain, the necessity of problematizing the stereotyped image of physics as an unquestionable monolithic body of knowledge was stressed. MER, on the contrary, stressed to what extent science and physics, like every cultural product, were "plastic" and mouldable according to many different aims, among which are educational ones (Kattmann, Duit, Gropengießer & Komorek, 1996). For us, the idea of educational reconstruction attained a special meaning after the presentation of the UNESCO report by Sjøberg in Tessaaloniki, where he said: "A key aspect in the lives of young is the search for meaning and relevance. They like areas where their voice is taken seriously, where their views count. Science and mathematics have an image of authority, at least as school subjects. Answers are either right or wrong. There is no place for arguments and personal views. [...] The lack of personal meaning and the image of eternal truth and correct answers put off more young people today than before." (Sjøberg, 2001)

Sjøberg, in stressing the problem of the relevance, was, in our opinion, shifting the main problem for Physics Education from making physics easier and easier to widening and enriching the perspectives.

In the light of these milestones, the construction of the materials was oriented toward reaching the goal of making physics *simple enough to be intelligible but not so simple to loose its relevance*. In the wake of Levy-Leblond, trivialization became the killer of the sense, the "New Medusa" to be avoided as much as possible: "More than the complexity of the original concepts of science, it is, on the contrary, their trivialization [...] that, as soon as the concepts reach non-specialized public, exerts a real spell that petrifies them" (Levy-Leblond, 2006).

In order to design new materials able to avoid concepts' petrification, we searched for forms of *productive complexity* to be elevated to the rank of design principles, namely principles that could orient us in producing materials enable to encourage secondary students both to attach a cultural value to physics and to find their "place for arguments and personal views" (Sjøberg). The forms of productive complexity that became the design principles in our MER are what we called *multi-perspectiveness*, *multi-dimensionality* and *longitudinality*. These principles were applied to design materials for teaching relativity, quantum physics (Levrini & Fantini, 2013) and thermodynamics (Levrini, Fantini, Tasquier, Pecori & Levin, 2014b).

In the case of thermodynamics, which is the focus of this paper, *multi-perspectiveness* means that the same content is analyzed from two different perspectives: macroscopic and microscopic. The expected impact of multi-perspectiveness was to enable students to address the documented learning difficulties related to the confusion between macroscopic and microscopic aspects (e.g. Kautz et al., 2005) and, more in general, to improve their conceptual understanding by guiding them to try out the same concepts across multiple

¹ The terms *culture* and *cultural* are used by us with a similar meaning to which Igal Galili gives to them and that he describes in his contribution to this volume and that is illustrated in Levrini et al, 2014a.

contexts and definitions (Levrini & diSessa, 2008).

In our materials and during their implementation in class, the macroscopic and microscopic approaches were analyzed and compared also for their philosophical-epistemological peculiarities. This is what is meant by the principle of *multi-dimensionality*. Operationally, multidimensionality was introduced through specific activities: i) individual analysis of epistemological texts where different authors (Einstein, Poincaré and Drago) discuss their own criteria for distinguishing and comparing the two approaches, and ii) collective discussions where students were encouraged to confront their analyses in order to build a shared classroom epistemological vocabulary. The choice of multi-dimensionality was mainly motivated by the intention of making the learning environment inclusive and “psychologically safe” (Nasir, Rosebery, Warren & Lee, 2006). As Nasir and colleagues argue, inclusiveness is fostered when the epistemological structure of the discipline is made visible and challenge the authoritative and exclusive image of science in which a unique point of view is legitimate (and possible).

Finally, *longitudinality* means that thermodynamics was not simply introduced as a separate chapter of physics, but as a lens for looking “back” toward theories already studied by the students (optics, mechanics, relativity) and looking “forward” toward new theories (quantum physics). Operationally, longitudinally was implemented by focusing on modeling and by progressively guiding the students to look back toward mechanics and become acquainted with the analogical meaning of physical models of objects (like point-mass or ideal fluid) when they are “borrowed” from mechanics and used in contexts like thermodynamics.

In the case of the study reported in this paper, the materials on thermodynamics were implemented in a class of 20 students (17 year olds) of a scientifically-oriented secondary school in Rimini, Italy. The implementation took about 25 school-periods and the teacher, Paola Fantini, was involved also in the design and, then, in the analysis of the data.

It was in this context that during the implementation of the thermodynamics path something that positively surprised us happened. Students not only showed to be able to cope with the documented difficulties in understanding the basic concepts of thermodynamics and felt the learning environment “psychologically safe,” as we hoped. They also, instead of that “schoolish” language that students usually use by borrowing expressions from the teacher or the textbooks, appeared to make sense of the material in personal ways and used, in their speech, idiosyncratic words and utterances. It was for interpreting such a phenomenon that we designed and realised the study presented in the next section.

3. What happened in the class

To interpret the phenomenon that we perceive in the classroom, we searched for an inspirational word and, at a suggestion of Paolo Guidoni, we focused on the term *appropriation*. Appropriation is not far from Vygotsky’s internalization, but, at least in Italian, it is a common word used in teaching and, because of that, it sounds semantically richer than the “technical” internalization. In particular, appropriation was chosen for the following meanings that can be attached to it: it a) appropriation indicates a process broader than learning and involves cognition, affect, emotion and social behaviour, ii) to appropriate means “to make something mine” and, hence, it includes the idea that the accountability of the appropriation process is situated with the students, iii) appropriation has the same etymological meaning of authenticity. *Autos* in ancient Greek and *proper* in Latin have the same meaning: “of one’s own”.

Within the literature, the description of appropriation that we prefer comes from Bakhtin, who wrote: “It [a word] becomes ‘one’s own’ only when the speaker populates it with his own intentions, his own accent, when he appropriates the word, adapting it to his own semantic and expressive intention. Prior to this moment of appropriation, the word [...] exists in other people’s mouths, in other people’s contexts, serving other people’s intentions: it is from there that one must take the word, and make it one’s own.” (Bakhtin, 1981, pp.293-4)

That is a very evocative description but we needed something different for interpreting our phenomenon: a more operational construct that could help us understand if students’ discourse revealed whether they did appropriate thermodynamics words. Thus, we worked on our data to bootstrap our definition from them. In a recent paper the whole process of data analysis is described in detail (Levrini et al, 2014b). Here I simply report the main results so as to argue why we can infer that the learning of physics can become a vehicle of identity construction.

The study was realized on the transcripts of eight individual semi-structured interviews that were conducted at the end of the period of data collection. Five interviews were used as core data corpus from which we built our first draft definition. The other three interviews, the most complicated and subtle ones, were used both as contrastive cases (they appeared cases of non-appropriation) and cases to check if our definition was an

effective operational tool to acknowledge appropriation (its application led as to discover that only one case out of the three was a real case of non-appropriation). The overall analysis resulted in the identification of five discursive markers for deciding whether students made progress in learning not only the disciplinary content of the teaching/learning path, but also in making the material relevant in a personal sense. In particular, the analysis led us to argue that appropriation can be operationally recognized when students' discourse about a scientific term/utterance is:

- A. developed around a set of words or expressions repeated several times and linked together so as to express an *personal, authentic, idiosyncratic "signature" idea* with respect to physics (thermodynamics, in this case) ;
- B. *disciplinarily-grounded* i.e. the signature idea was used by the student as a tool for selecting pieces of disciplinary knowledge;
- C. *thick* i.e. the signature idea involved a metacognitive dimension (what learning physics meant for the student) and an epistemological one (what image of physics made sense to the student);
- D. *non-incidenta*l, i.e. the signature idea was expressed in several activities throughout the students' classroom experience, not just in one interaction;
- E. *carrier of social relationships*, i.e. the signature idea positioned the student within the class community (the "engineer", the "philosopher", the "mediator"...))

To exemplify the markers I will consider the case of Matteo. His interview developed around the philosophical words "being" and "becoming" that he repeated several times. From this evidence we could recognize, as idiosyncratic "signature" idea, the philosophical distinction between "being" and "becoming". The signature idea is grounded in the discipline in the sense that, in the case of Matteo, it helped him to make sense of thermodynamics concepts themselves. Indeed, when he was interviewed about the concept of temperature, Matteo focused his attention on the distinction between ΔT (temperature gradient) and T (temperature), because he saw, in this distinction, the philosophical difference between becoming (change) and being (a state). In particular, in the law of calorimetry ($Q=mc\Delta T$), Matteo saw an expression of becoming: "*there is a change [because of ΔT] that means everything is not stable and everything is not being, there is something that changes.*" In the Ideal Gas Law ($PV=nRT$) he instead saw an expression of being: "*[There is] absolute temperature T , that doesn't change. There is not Δ [difference in temperature], there is not the change....*" Already in the other classroom activities, Matteo showed a strong interest in philosophy and his learning of physics was strongly inflected by his orientation to philosophy. In this sense the signature idea was non-incidenta and expression of a epistemological positioning within physics (thick) and a personal positioning – "the philosopher" – within the class (carrier of social relationship).

Matteo, like the other students who appropriate the words and utterances of thermodynamics, didn't repeat the definition of temperature provided by the teacher or textbook. Instead, he gave back what was meaningful in his personal sense. Specifically, he focused his attention on pieces of knowledge related to temperature and reassembled them according to their idiosyncratic "signature" idea. In the words of Bakhtin, Matteo, in selecting and reassembling pieces of knowledge, populated a disciplinary word (temperature) with personal intentions and purposes. It is in this process, both idiosyncratic and social, that we see students to "play" with the self and to explore those "patterns of ways of doing [and saying] things", (diSessa, 2014, personal communication) that progressively result in what can be called identity construction.

4. Why appropriation occurred

In the current phase of the research, we are investigating the conditions and the factors that fostered students' appropriation. We retain that at the very basis of the process there are some features of our MER and its design principles. They indeed were chosen to create a learning environment inclusive and rich enough to encourage each student to pursue multiple explorations within the discipline and to find out their ways to experience it. Nevertheless, in order to see how the materials acted for appropriation we felt the need to focus our attention on teacher' actions and her orchestration's patterns.

In interviews, the teacher often repeated that her main teaching concern regarded the rhythm of her lessons and, in particular, the issue of how to tune collective and individual paces of learning. To describe the issue of how she tried to tune collective and individual paces of learning, she used a metaphor of "pulling the rope" and "letting it go" and we conjectured that this way of managing the class supported students' individual processes of appropriation. Consistently, two types of analysis were carried out with the aims of pointing out, respectively, what "pulling the rope" and "letting it go" looked like in terms of data, and what role these orchestration patterns could be observed to play in the process of appropriation. In order to pursue the goals,

we selected two contrasting lessons – one in which the teacher characterized the dynamic more in terms of “pulling the rope” (Lesson A) and one in which the lesson was more emblematic of what she meant by “letting it go” (Lesson B). The two lessons occurred at the end of the teaching/learning path, after approximately 20 hours of instruction on thermodynamics.

Lesson A was a *synthetic collective discussion* about the major aspects of the macroscopic approach to the second law of thermodynamics. The lesson included topics that were very close to the disciplinary content the students had been explicitly studying. In this lesson, the teacher directed questions at single students who were responsible to provide answers. An example of a question in Lesson A was “*Matteo, how are ideal engines connected with Kelvin’s statement? What is the formal expression of the efficiency for an ideal engine?*”

Lesson B was an *open and reflective discussion* on points related to epistemological texts (authored by Einstein and others) on methodological distinctions between macroscopic and microscopic approaches to building theories (e.g., Einstein’s distinction between “constructive” theories and “theories of principles”). This lesson was a specific moment where the design principles became explicit and oriented the classroom activities. Here, indeed, *multi-dimensionality* (an epistemological reflection) was applied to analyse *multiple perspectives* with a *longitudinal* glance. The discussion was articulated in three different moments, corresponding to three collective tasks introduced by the teacher through specific questions:

1) Requirement of verbalizing one’s own view about possible criteria for distinguishing and comparing the macroscopic and microscopic perspectives. This requirement was formalized by the following question that opened the discussion: *We arrived at the end of our path of Thermodynamics and you have reflected about these macro and micro approaches. So, now we are asking you (all) to express your own point of view, in a calm way, calm but express it. What difference do you see, now, between the two approaches?*

2) Requirement of interpreting other (authoritative) positions about the difference between the two approaches and searching for inner and longitudinal consistency. The teacher asked: *Why did Einstein include Special Relativity among the theories of principles and classical mechanics among the constructive theories? Are your criteria for distinguishing between theories of principles and constructive theories consistent with such a claim of Einstein?*

3) Requirement of positioning with respect to other possible views expressed by the classmates. This requirement was formalized by the teacher through this question: *What perspective do you prefer? Which one is, in your opinion, more effective to reach the core of a phenomenon? We had the impression that, in the class, there are different positions on this issue..*

In order to investigate how pulling the rope and letting it go appeared in terms of data, “bird’s eye maps” of the lessons were created by recording who was speaking and for how long (in 2 second increments). In figure 1 and 2, segments of the two lessons are reported.

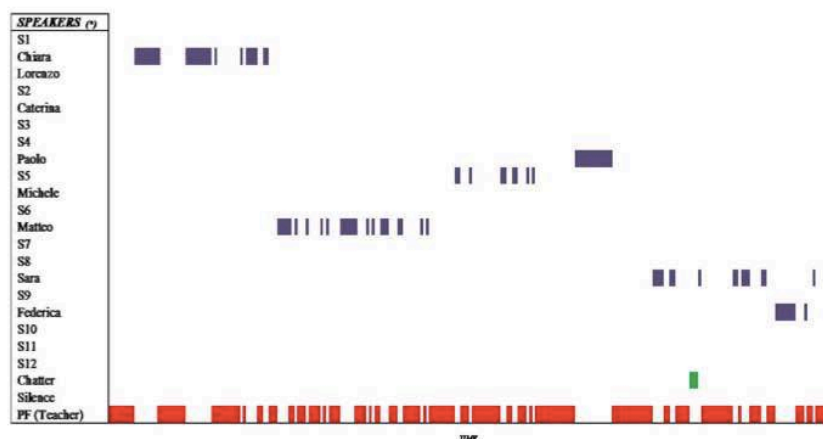

Figure 1. A segment of the interactional pattern in lesson A.

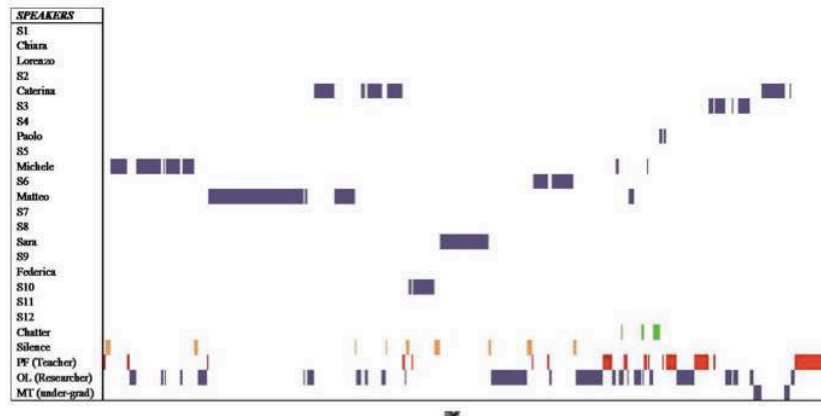

Figure 2. A segment of the interactional pattern in lesson B.

The maps point out some structural elements that characterize the different interaction patterns: the role of teacher in driving the lesson (very evident in lesson A); the moments of silence (absent in lesson A and more and more present in lesson B); the length of continuous bars of the students (very short in lesson A and longer in lesson B); the student-student interaction (absent in lesson A and present in lesson B).

In order to analyse if and how “pulling the rope and letting it go” fostered appropriation, we focused our attention on three focal students who were in different places with respect to the process of appropriation. The detailed analysis is reported in other works (Fantini 2014; Fantini, Levin, Levrini & Tasquier, pre-print). Here, I will focus on Matteo so as to illustrate the following results we achieved.

a) “Pulling the rope”, when analyzed at the level of the individual focal students, emerged as *an articulated form of revoicing* (O’Connor & Michaels, 1992) that the teacher enacted in order to: i) encourage a better positioning of the single student with respect to physics by fixing inaccurate points, ii) reinforce a disciplinary concept so as to enable reasoning to proceed, iii) emotionally support the student, iv) give the student credibility in front of the class.

In table 1, the teacher’s interaction with Matteo in Lesson A (Fig. 1) is reported and teacher’s revoicing is commented. For Matteo, the action of revoicing was particularly relevant since, in class discussions, he frequently tried to evade the more technical and formal aspects of physics and, for this reason, he was not considered a disciplinary reference in the eyes of his classmates. Despite this, and because of his ability to master philosophical arguments, he had a recognized intellectual position in the classroom community but, for the teacher, Matteo was a student who constantly needed to be kept close to the discipline.

Table 1 – Commented Excerpt from Lesson A

Turn	Transcript	Comments
1	Teacher: We have seen that from here [from the second law] come thermal machines and that the efficiency...	The teacher does not need to pose an explicit question. She suspends her voice to check where Matteo is, expecting him to pick up the thread.
2	Matteo: The efficiency in a cycle can not be greater than 1, but... However, this is also in an ideal cycle.	Matteo understands and picks up the thread of reasoning.
3	Teacher: Good. It <u>cannot be...</u> We are considering an <u>ideal cycle</u> , an ideal, <i>reversible</i> cycle as Carnot did. So?	The teacher revoices Matteo’s contribution following confirmation that his reasoning is correct. (“Good. It cannot be...), but it can be more accurate.
4	Matteo: It must necessarily be smaller than 1.	Matteo understands and immediately fixes the imprecision.
5	Teacher: Exactly. <u>Smaller than 1</u> , not higher and not even equal.	The teacher’s re-voicing here serves the purpose of <i>underlining and reinforcing the student’s contribution</i>

		(Smaller than 1 <i>means</i> not higher and not even equal).
6	Matteo: exactly, not even equal	Matteo's re-voicing serves the purpose of <i>giving feedback</i> that he is following. He is now well positioned on the point.
7	Teacher: If it were equal ... Tell me, efficiency is equal to...	The teacher invites and supports Matteo in grounding his argument on formalism.
8	Matteo: Work is equal to work over heat absorbed.	
9	Teacher (writing the formula Matteo is dictating on the blackboard): Good. Work is equal to... tell me it in terms of heat.	The teacher writes: $\eta = \frac{W}{Q_{abs}} = \frac{Q_{abs} - Q_{lost}}{Q_{abs}}$
10	Matteo: Heat absorbed minus heat lost	
11	Teacher: If the efficiency were 1, which of these terms would be zero?	The teacher encourages Matteo to complete his reasoning.
12	Matteo: The heat lost ... and this is not possible.	Matteo provides, finally, the right, complete and well-argued response.

b) In the context of the discussion of the epistemological questionnaire, “letting the rope go” emerged, at individual level, as an *articulated participation framework* that encouraged different types of students to take part in the discussion. The first moment – requirement of verbalizing – encouraged mainly the participation of self-confident students, while the second moment was a collective puzzlement and all the students were asked to contribute to a collective brainstorming. Here intuitive, creative or deep thinkers students felt particularly comfortable. The third moment – requirement of positioning with respect to the classmates – invited the students, like Matteo, who like debates and who found confrontation of ideas as a useful way to express his own ideas.

The combination of “pulling the rope” and “letting it go” provided all the conditions that we pointed out as relevant for appropriation, corresponding to our five markers. “Pulling the rope” enabled students to find their positioning with respect to the discipline (Marker B) and to the class (Marker E). “Letting the role go” allowed students to nurture their talent in seeking out and defending a personal point of view, among a range of possibilities (Markers A, C, D).

5. Conclusions

In the paper I went through a long process of research that progressively led us to enrich our focus on instructional design with learning sciences concerns. In particular, through an overview of our research program and results I tried to show in what sense we say that, in properly complex classroom environments, learning *of* and *in* a science discipline becomes a way for students to construct their personal narratives and in what sense appropriation stays in the nexus between productive disciplinary engagement and identity construction. As a last remark, probably not all the students had fun in this work. For some of them it was also dramatic, since a strong personal involvement touches deep issues. In any case, I feel comfortable in saying that most of them, if not all, felt they were studying something important and worthwhile: learning physics was, for the class and for the single students, a transformative experience.

Acknowledgement

I wish to thank all the colleagues who have been working on this project since the late '90s (Nella Grimellini Tomasini, Paola Fantini, Paolo Guidoni, Mariana Levin, Barbara Pecori, Giulia Tasquier) and the other colleagues of the research group of Bologna (Eugenio Bertozzi, Laura Branchetti, Marta Gagliardi). A special thanks to Rosa Maria Sperandeo, Claudio Fazio and to the GIREP President, Marisa Michelini, for inviting me to give a talk at this Conference.

References

- Bakhtin, M. (1981). Discourse in the novel (M. Holquist & C. Emerson, Trans.). In M. Holquist (Ed.), *The dialogic imagination* (pp. 259-422). Austin: University of Texas Press.
- Busini D., Tarsitani C. (1996), Macroscopic vs. Microscopic: a Problem of History, Epistemology and Teaching of Physics, *Proceedings of the GIREP-ICPE Conference* (Udine, Italy)
- Cobb, P., Gresalfi, M. & Hodge, L. L. (2009). An Interpretative Scheme for Analyzing the Identities That Students Develop in Mathematics Classrooms. *J. for Res. in Math. Ed.*, 40(1), 40-68.
- Fantini, P. (2014). *Verso una teoria locale dell'appropriazione nell'insegnamento/apprendimento della fisica*. PhD Dissertation Thesis.
- Fantini, P., Levin, M., Levrini, O. & Tasquier, G. (pre-print) Orchestrating Classroom Discussions to Foster Appropriation.
- Gee, J. P. (2001). Identity as an analytic lens for research in education. *Rev. of Res. in Ed.*, 25, 99–125.
- Giddens, A. (1991). *Modernity and Self-Identity: Self and Society in the Late Modern Age*, Stanford University Press.
- Grimellini Tomasini, N. (2004). Teaching physics from a cultural perspective: Examples from research on physics education. In E. F. Redish & M. Vicentini (Eds.), *Research on physics Education. Proceedings International School of Physics "E. Fermi"*, IOS press, SIF, Bologna, 559-582.
- Kattmann, U., Duit, R., Gropengießer, H. & Komorek, M. (1996). Educational Reconstruction -bringing together issues of scientific clarification and students' conceptions. Paper presented at the Annual Meeting of NARST, St. Louis (MI), April 1996.
- Kautz, H., Heron, P. R. L., Loverude, M. E. & McDermott, L. C. (2005). Student understanding of the ideal gas law, Part I: A macroscopic perspective, *Am. J. of Phys.* 73, 1055–1063.
- Levy-Leblond J-M (2006). *La vitesse de l'ombre: aux limites de la science*, Paris: Seuil.
- Levrini, O., diSessa, A.A. (2008). How Students Learn from Multiple Contexts and Definitions: Proper Time as a Coordination Class. *Phys. Rev. Special Topics - Physics Education Research* 4, 010107.
- Levrini, O., Fantini, P. (2013). Encountering Productive Forms of Complexity in Learning Modern Physics. *Sc. & Ed.*, 22 (8), 1895–1910, DOI 10.1007/s11191-013-9587-4
- Levrini O., Bertozzi E., Gagliardi M., Grimellini-Tomasini N., Pecori B., Tasquier G., Galili I. (2014a). Meeting the discipline-culture framework of physics knowledge: a teaching experience in Italian secondary school, *Sci. & Ed.*, 23, 1701–1731, DOI 10.1007/s11191-014-9692-z.
- Levrini, O., Fantini, P., Tasquier, G., Pecori, B. & Levin, M. (2014b). Defining and Operationalizing 'Appropriation' for Science Learning, *J. of the Lear. Sci.*, DOI:10.1080/10508406.2014.928215.
- Nasir, N.S. & Hand, V. (2008). From the Court to the Classroom: Opportunities for Engagement, Learning, and Identity in Basketball and Classroom Mathematics, *J. of the Lear. Sci.*, 17:2, 143-179.
- Nasir, N.S., Rosebery, A.S., Warren, B. & Lee, C.D. (2006). Learning as a Cultural Process. In Sawyer K. (ed.), *The Cambridge Handbook of The Learning Sciences*, Cambridge University Press, 489-504.
- O'Connor, M. C., & Michaels, S. (1996). Shifting participant frameworks: Orchestrating thinking practices in group discussion. In D. Hicks (Ed.), *Discourse, learning, and schooling* (63-103). New York: Cambridge University Press.
- Sfard, A. & Prusak, A. (2005). Telling Identities: In Search of an Analytic Tool for Investigating Learning as a Culturally Shaped Activity. *Ed. Res.*, 34: 14 DOI: 10.3102/0013189X034004014.
- Sjøberg, S. (2001). "Why don't they love us any more?" Science and technology education: A European high priority political concern! In D. Psillos et al. (Eds.), *Proc. of the Third Int. Conf. of the ESERA: Science Education Research in the Knowledge Based Society* (Vol. 1, pp. 19–21). Thessaloniki, Greece: European Science Education Research Association.

Affiliation and address information

Olivia Levrini
 Department of Physics and Astronomy
 Alma Mater Studiorum – University of Bologna

Viale Berti Pichat 6/2, 40127 Bologna, Italy
e-mail: olivia.levrini2@unibo.it

Research-Based Interactive Simulations to Support Quantum Mechanics Learning and Teaching

Antje Kohnle

School of Physics and Astronomy, University of St Andrews, UK

Abstract

Quantum mechanics holds a fascination for many students, but its mathematical complexity can present a major barrier. Traditional approaches to introductory quantum mechanics have been found to decrease student interest. Topics which enthuse students such as quantum information are often only covered in advanced courses. The QuVis Quantum Mechanics Visualization project (www.st-andrews.ac.uk/physics/quvis) aims to overcome these issues through the development and evaluation of interactive simulations with accompanying activities for the learning and teaching of quantum mechanics. Simulations support model-building by reducing complexity, focusing on fundamental ideas and making the invisible visible. They promote engaged exploration, sense-making and linking of multiple representations, and include high levels of interactivity and direct feedback. Some simulations allow students to collect data to see how quantum-mechanical quantities are determined experimentally. Through text explanations, simulations aim to be self-contained instructional tools. Simulations are research-based, and evaluation with students informs all stages of the development process. Simulations and activities are iteratively refined using individual student observation sessions, where students freely explore a simulation and then work on the associated activity, as well as in-class trials using student surveys, pre- and post-tests and student responses to activities. A recent collection of QuVis simulations is embedded in the UK Institute of Physics Quantum Physics website (quantumphysics.iop.org), which consists of freely available resources for an introductory course in quantum mechanics starting from two-level systems. This approach immediately immerses students in quantum phenomena that have no classical analogue, using simpler mathematical tools that allow a greater focus on conceptual understanding. It allows from the start a discussion of interpretative aspects of quantum mechanics and quantum information theory.

This article gives an overview of the QuVis resource and describes the development and iterative refinement process based on student feedback.

Keywords

Quantum mechanics, computer simulations, conceptual understanding.

1. Introduction

Quantum mechanics holds a fascination for many students, but learning quantum mechanics is difficult. The counterintuitive behaviour of quantum systems often disagrees with our classical ideas, leading to student difficulties that arise when classical thinking is applied to quantum systems (see e.g. Singh 2001, Cataloglu 2002, Wittmann 2005, Baily 2010 and Zhu 2012). Quantum phenomena typically cannot be observed directly and are far-removed from everyday experience. Complicated mathematics including calculus, complex numbers and differential equations are required to describe even simple phenomena. Linked to this, instruction often focuses on particularly simple abstract and idealized systems that are mathematically tractable but may not help learners make real-world connections to quantum phenomena.

Research-based interactive simulations can address these challenges of quantum mechanics instruction and support quantum mechanics learning and teaching. Simulations can help students develop mental models by reducing complexity, focusing on fundamental ideas and making the invisible visible (Adams 2008a, Adams 2008b, McKagan, 2008). Through high levels of interactivity coupled with direct feedback, they can promote engaged exploration, sense-making and linking of multiple representations (Clark 2011). Through careful interaction design and accompanying activities, students can be guided towards the learning goals (Podolefsky 2010). Simulations can visualize complicated time-dependent behaviour such as the motion of wave packets that help build physical intuition but may be too complex for students to calculate themselves (Belloni 2006). Simulations can allow students to collect data to see how quantum-mechanical quantities are

determined experimentally. Simulations can help build physical intuition by allowing students to compare and contrast classical and quantum behaviour under the same experimental conditions (Kohnle 2014). They can challenge students' classical ideas by allowing them to assess whether they can explain experimental outcomes.

The QuVis Quantum Mechanics Visualization project aims to support the learning and teaching of quantum mechanics through the development and evaluation of interactive simulations with accompanying activities. This article gives an overview of the QuVis simulations and describes the research-based development process that aims to optimize simulations and accompanying activities in terms of clarity, ease-of-use, promoting exploration, sense-making and linking of multiple representations. It gives examples of features of the simulations that are aligned with previous work on developing effective educational simulations. It gives examples illustrating how student feedback from individual student interviews and in-class trials was used to optimize the resources. Finally, it summarizes future plans.

2. Overview of the QuVis interactive simulations

The QuVis Quantum Mechanics Visualization Project (www.st-andrews.ac.uk/physics/quvis) develops interactive simulations for the learning and teaching of quantum mechanics concepts (Kohnle, 2010 and Kohnle, 2012). The QuVis website now includes over 90 research-based interactive simulations. Simulations are research-based, with student feedback informing all stages of the development process. Simulations are freely available for use online or download. Simulations cover a wide range of quantum mechanics topics, ranging from the introductory to the more advanced undergraduate level. Simulations include many topics not covered in other multimedia collections. Some of the QuVis simulations make topics typically covered at the advanced level (entanglement, hidden variables, quantum cryptography) accessible to introductory level students. The majority of simulations include an accompanying activity available for download from the website. Full solutions to these activities are available on the website, but password-protected for instructor access only. Instructors who wish to obtain the password for the solutions are asked to email the author.

The QuVis website groups the simulations into four collections: simulations for physics students, for physical chemistry students studying introductory quantum mechanics, simulations to support a new introductory quantum mechanics curriculum based on two-level systems and a recently-launched collection of HTML5 simulations that run on both desktop computers and tablet-based devices. The previous three collections were coded in Adobe Flash.

The "QuVis simulations for physics" collection includes mostly older simulations developed in 2009 to 2011, with 50 simulations in total available. The majority of simulations are aimed at the intermediate level and focus on wave mechanics and angular momentum. A smaller number of simulations are aimed at the introductory level (e.g. probabilistic analysis of classical systems, the photoelectric effect, the Bohr atom) and the more advanced level (e.g. the density matrix, spin clusters and spin chains).

The "QuVis simulations for physical chemistry" collection includes 18 simulations that are less mathematical compared with the physics collection, and include text explanations tailored to chemistry students. Topics of the simulations link to Atkins' "Physical Chemistry" textbook, with most simulations developed so far focusing on basic quantum theory. A number of simulations were adapted from the physics collection, others were newly developed specifically for physical chemistry students.

The "New Quantum Curriculum sims" collection consists of 17 simulations with accompanying activities that were developed in 2012 to 2013 as part of the UK Institute of Physics (IOP) Quantum Physics resources (Kohnle 2014). These simulations are available both on the IOP website quantumphysics.iop.org and on the QuVis website. The IOP resources were developed as a national UK project. They include around 80 short articles centred on questions with multiple paths through the material. Articles were authored by researchers in quantum information theory and foundations of quantum mechanics. Problem sets, simulations and activities are embedded into the articles. Resources provide material for a full course in introductory quantum theory focusing on two-level systems. Examples of such systems are a spin $\frac{1}{2}$ particle, a two-level atom with a ground state and a single excited state, and a single photon in an interferometer with two possible paths. Developing quantum theory using two-level systems has a number of advantages (Micheli 2000, Scarani 2010, Beck 2012, Kohnle 2014 and Malgieri 2014). It allows from the start a focus on experiments that have no classical explanation. It allows from the start a focus on interpretive aspects of quantum mechanics and quantum information technology. It is also mathematically less challenging, requiring only basic algebra versus differential equations and calculus for the more traditional wave mechanics approach. The IOP resources are freely available but require registration. The simulations cover the topics of linear

algebra, fundamental quantum mechanics concepts, single photon interference, the Bloch sphere representation, entanglement, local hidden variables and quantum information.

The recently launched collection of HTML5 simulations includes a revised layout optimized for both desktop computer and touchscreen use. Controls are more widely spaced, and the active area around each control has been increased for ease-of-use on smaller touchscreen devices. Graphics and displayed quantities are mostly positioned at the top of the window and controls mostly at the bottom, in order to reduce hand obscuration of feedback on touchscreens. Simulations in this collection include both recoded simulations from other collections as well as newly developed simulations. Older simulations from the physics collection are being revised in terms of layout and graphics prior to the recoding. For the New Quantum Curriculum simulations, revisions from in-class trials are being incorporated where needed prior to recoding.

3. Overview of the research-based development process

Figure 1 depicts the stages of the QuVis simulation development and refinement process. Ideas for simulations come from lecturing and tutoring experience and the literature on student difficulties in quantum mechanics.

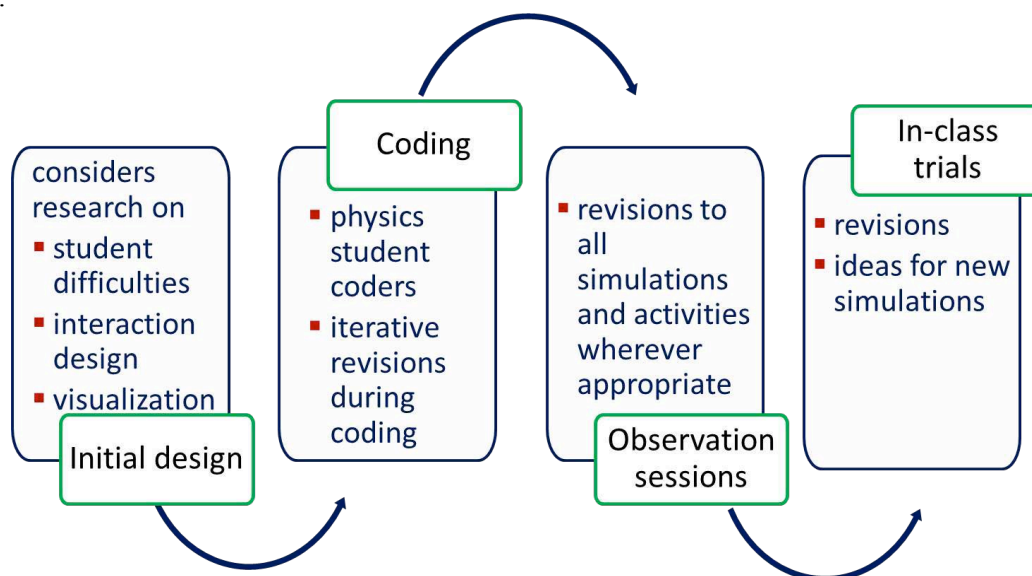

Figure 1. Overview of the simulation development process.

The development process starts by defining learning goals for a simulation. Learning goals inform the development of the simulation, activity and assessment instruments used to evaluate effectiveness. The learning goals are typically limited to a single concept per simulation (e.g. degeneracy of states or single photon interference). This reduces complexity and allows the simulation to focus on key ideas, reducing cognitive load. It also allows the simulation to lead students towards the learning goals through the interaction design, e.g. the number and types of controls, their ranges and layout. The initial design considers the literature on interaction design (Saffer 2010), research into student difficulties and research into what makes a good visualization (López 2013 and Chen 2014).

After initial drafting, simulations are coded by undergraduate physics students. These students often have suggestions for revisions to layout or content based on aspects they find confusing or non-intuitive. Thus, student input already informs the development phase. During the coding, the layout is iteratively revised based on experience interacting with draft versions.

Once the simulation is fully coded, it is refined using student feedback from the appropriate level, first in individual student observation sessions and then using in-class trials (Kohnle 2013). Figure 2 shows the research methods used in these trials and their primary focus.

In the individual student volunteer sessions, students first interact freely with a simulation until they feel they are finished. The free exploration phase makes it possible to assess the implicit scaffolding, e.g. whether students are guided through the interaction design towards the learning goals. Students are asked to think out loud during this process, and to describe what they are making sense of and what they are finding confusing. After freely exploring the simulation, students work on the accompanying activity. This makes it possible to assess whether questions are unambiguous and whether the simulation and the activity provide sufficient

scaffolding for students to successfully complete the questions. During this process, the only interventions made are to remind students to articulate their thoughts, and to probe further when a student states they are confused and unable to make progress. If this latter situation arises, the student is first asked whether they can find anything in the simulation itself to help them overcome their difficulties. If not, further questions aim to discern how the student could overcome their difficulty, e.g. through an additional control in the simulation, additional information or rephrasing of text. The aim of posing these questions is to find patterns in student difficulties and ways to overcome them.

Directly after working with the simulation, students then complete survey questions on their experience of using the simulation. Survey questions ask about clarity of graphics, displayed quantities, texts and the activity, ease-of-use, perceived usefulness in enhancing understanding and how enjoyable students found working with the simulation. Students are asked to make comments on points found confusing and suggestions for improvement. These observation sessions are typically two hours in duration, with mostly two and sometimes three simulations used.

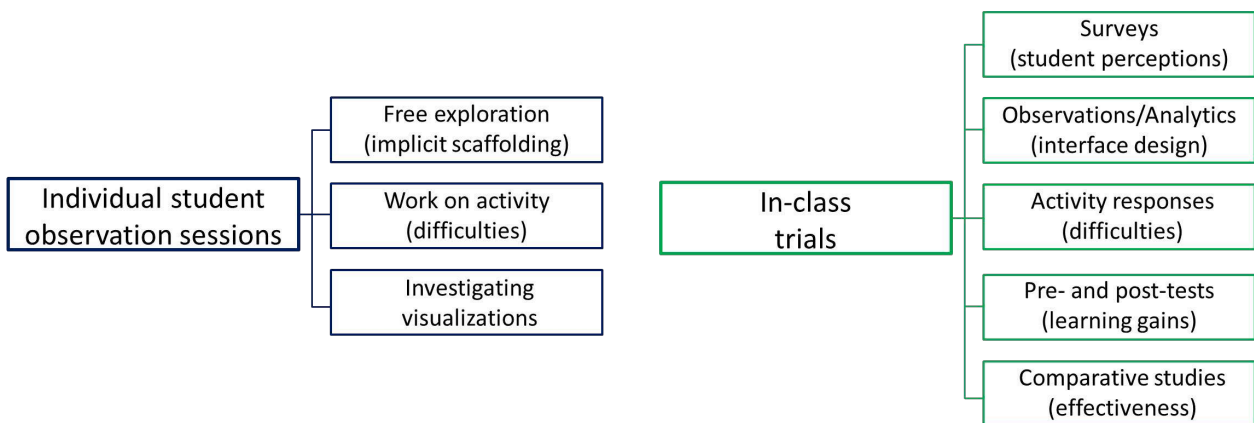

Figure 2. Overview of research methods used in the development and evaluation process and their primary focus.

The observation sessions are audiorecorded and use screencapture. Observers take notes during the sessions, and write detailed session notes with impressions after the sessions. These individual sessions typically lead to revisions to interface and content, which are incorporated into all simulations wherever relevant. Especially for more substantial revisions, a second round of observation sessions is carried out to assess the impact of revisions. This typically leads to a second round of more minor revisions. Observation sessions are also used to investigate the effect of different visualizations on student understanding, e.g. the visualization of the photon superposition state on student understanding of quantum superposition.

While the observation sessions give in-depth information on students' interactions and perceptions and make it possible to ask questions to explore possible changes to the simulation and the activity, they are carried out with only a relatively small number of students that have volunteered for this activity. Thus, issues identified may not be representative, and generalization of outcomes raises issues of validity.

Once revisions from observation sessions are incorporated, in-class trials are used to evaluate simulations with a larger number of students. For the in-class trials, a range of methods are used to evaluate the simulations and accompanying activities (see Figure 2), with a subset of these methods used for each of the trials. Directly after working with a simulation, students complete the same survey questions as in the observation sessions on perceived clarity of different elements, ease-of-use, perceived usefulness in improving understanding, points found confusing and suggestions for improvement. For in-class trials that use simulations in computer classroom sessions, students are observed during these sessions. Google Analytics is used to monitor usage of individual controls, e.g. to determine the fraction of students in a class that used a particular control and the average number of times a control was used. Thus, it is possible to assess whether students find and use all the controls and the frequency of control use. Students' responses to the activity questions are marked as correct or incorrect to assess whether any questions are on average not answered well. Activity questions not answered well point to issues with the simulation and/or the activity. For simulations with in-built challenges, it is possible to assess student success in completing these challenges, which form part of the activity problems. For a subset of simulations, short pre- and post-tests have been developed that students complete prior to and after working with a simulation. These pre- and post-tests assess learning gains through working with a simulation. The pre- and post-tests are mostly in multiple choice format, but also ask students to explain their reasoning and to rate their confidence in their

answer. This makes it possible to verify that students choosing the correct answer have come to their answer using correct reasoning. Finally, a small number of comparative studies have been carried out. These studies have investigated student learning with two groups of students using somewhat different versions of a simulation, compared students' interactions with a simulation with one group using the simulation to learn a new concept, the other using the simulation to consolidate the concept, and compared use of a simulation with a pencil-and-paper activity. These comparative studies can evaluate the effectiveness of simulations compared with other instructional strategies, and assess the effectiveness of using simulations in different settings or with different visualizations.

Data collected from the evaluation studies include student responses to survey questions, activities, pre-tests and post-tests. Data analysis uses a combination of quantitative and qualitative techniques. Free-text survey responses are grouped according to common themes and patterns in student responses. For the activity, pre-test and post-test responses, student answers are marked as correct or incorrect to assess the fraction of students with correct responses, and incorrect responses are grouped into common ideas. Some of the in-class trials point to further revisions needed, which are typically minor compared with revisions from the observation sessions. All simulations and activities are revised based on evaluation outcomes wherever appropriate.

For the 17 simulations in the “New Quantum curriculum sims” collection, in total 42 hours of observation sessions were carried out with 19 student volunteers, 17 of which were from the introductory level. Much of the content of the simulations was new to these students. In-class trials have so far been carried out with 9 of these simulations, 5 at the introductory level and 4 at the advanced undergraduate level.

4. Aspects of simulations and activities that make them useful for learning

Figure 3 shows student perceptions of the usefulness of QuVis simulations in improving their understanding for an introductory quantum physics course (using 5 simulations in total) and an intermediate-level quantum mechanics course (using 17 simulations in total). This data is from end-of-course surveys conducted at the University of St Andrews in the 2013/14 academic year. Figure 3 shows that students across both levels find the simulations useful for their learning. Our experience is that these positive results are only possible due to our iterative development and refinement process informed by student feedback.

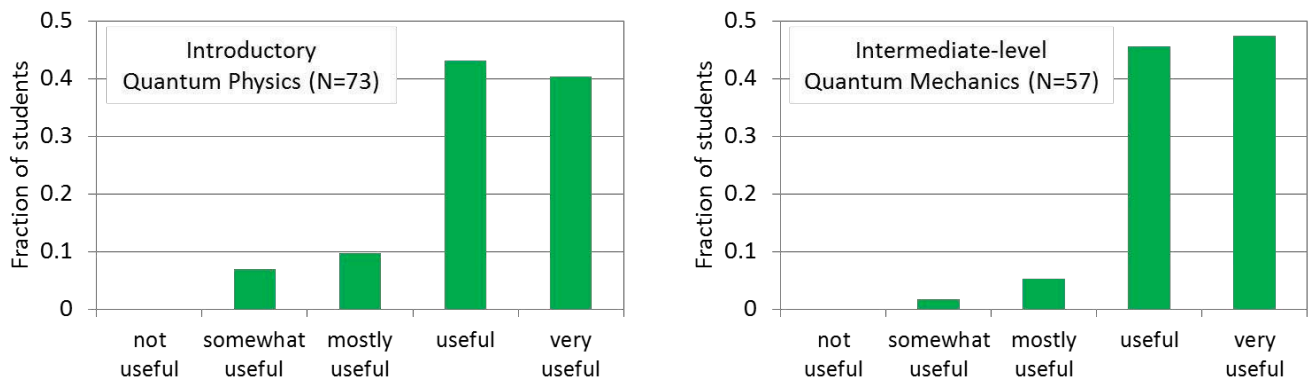

Figure 3. Student responses to an end-of-course question “How useful for learning quantum physics have you found the simulations used in the course?” for two courses at the University of St Andrews in the 2013/14 academic year.

This section describes how aspects of the simulations are aligned with previous work on developing effective educational multimedia resources. Examples are given of student feedback from individual student interviews and in-class trials, and how this feedback was used to optimize the simulations and accompanying activities.

5. Implicit scaffolding using interaction design principles

Simulation controls that are difficult to master or non-intuitive lead to a focus on the control and user frustration instead of a focus on the content (Adams 2008a and Podolefsky 2010). Limiting the number of controls and complexity of simulations and avoiding extraneous material not directly linked to the key learning goals are important to enhance learning (Podolefsky 2010 and Clark 2011). The QuVis simulations are designed according to principles of interaction design and refined using outcomes from our evaluation studies.

These points are illustrated using the *Interferometer experiments with photons, particles and waves* simulation (Figure 4). This simulation aims to help students develop an understanding of single photon interference by allowing students to compare and contrast the behaviour of classical particles, electromagnetic waves and single photons when passing through the same experimental setup. Students can insert a single beamsplitter or build an interferometer, and for waves and photons insert a phase shifter to vary the relative phase between the two arms. The simulation depicts single photons and the photon superposition state in order to help students develop a productive mental model of single photon interference. This simulation was trialed in five individual student observation sessions and used in introductory courses in 2013 and 2014, with somewhat different photon visualizations used in each of the in-class trials.

The QuVis simulations have a similar look-and-feel, so that students recognize the same interactive features and experimental apparatus across simulations. For example, the design of the optical components and detectors in the *Interferometer experiments with photons, particles and waves* simulation is consistent across all single photon simulations. Simulations use interactive controls such as sliders, radio buttons and tick boxes that are familiar to students. The layout is similar across all simulations, with displayed quantities and controls clearly separated from the graphics or experimental apparatus.

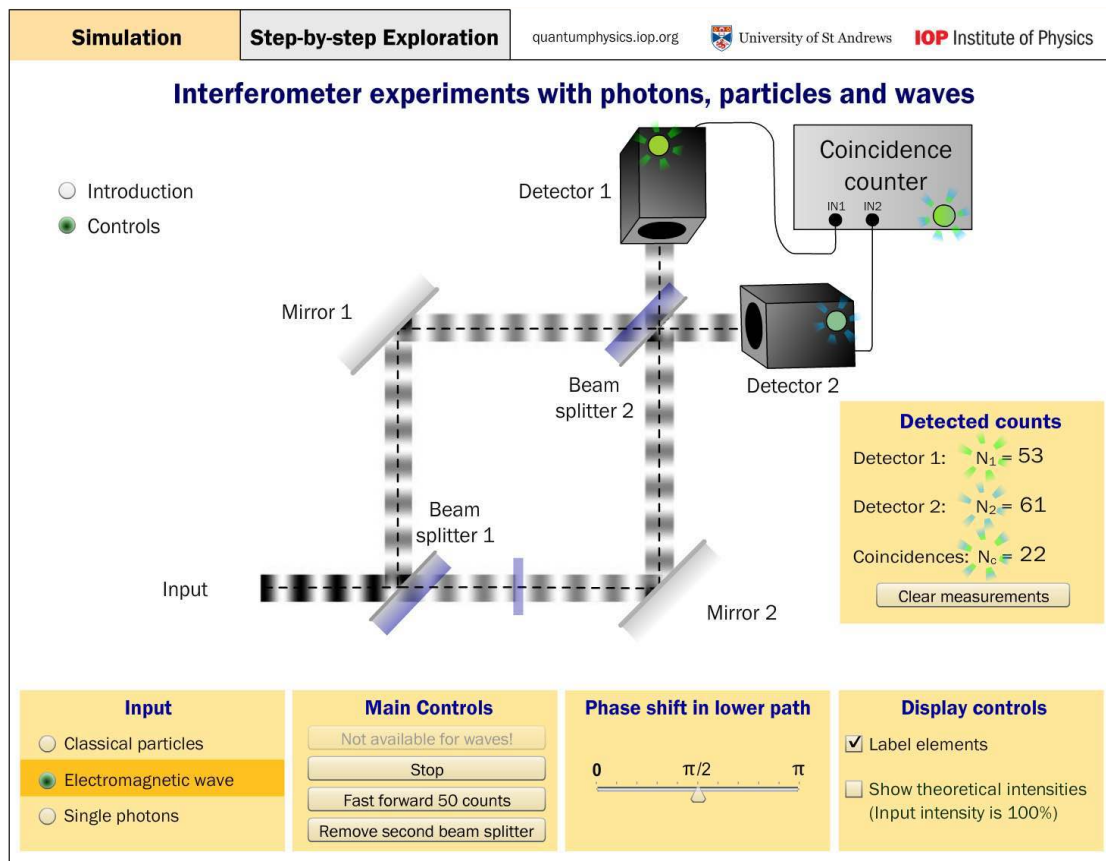

Figure 4. A screenshot of the *Interferometer experiments with photons, particles and waves* simulation, which allows students to compare and contrast the behaviour of single photons, particles and waves under the same experimental conditions.

The QuVis simulations make use of the fact that in the Western world controls are typically explored from top to bottom and left to right (Saffer 2010). This behaviour is also seen in the observation sessions. Thus, features students should find early on are placed at the top and left. Input states that can be chosen via radio buttons are ordered to progress from simpler to more complex states from top to bottom. In Figure 4, the order of the input controls helps scaffold students' exploration to first set up experiments with classical particles and electromagnetic waves before exploring the single photon case. Thus, the order of controls helps students to activate prior knowledge before exploring a new situation. Grouping of controls using panels makes use of the fact that adjacent controls are perceived to be related (Saffer 2010).

Initial configurations need to be kept simple, to encourage exploration and avoid overwhelming students (Adams 2008a and Clark 2011). The initial configuration in all simulations includes introductory text to give context to the situation shown. For the *Interferometer experiments with photons, particles and waves* simulation, the start-up screen is an Introduction view where students are asked to select the individual components of the experiment to learn more about them. Selecting a component brings up a brief text explanation directly adjacent to the component. The Introduction view tells users to choose the Controls button once they have learned more about the individual components of the experiment. Separating the Introduction and Controls views in this form allows us to scaffold students' exploration, so that students first learn about the components of the experiment in order to make sense of experimental outcomes when they progress to the Controls view.

The form of this introductory text was revised based on outcomes of the observations sessions. Initially, the introductory text was a single block of text. In the observation sessions, while students found this introductory text very helpful for making sense of the simulation, some students found the amount of text was overwhelming. Some students also commented that they amount of text made the simulation less enjoyable to work with. Thus, the Introduction view was revised to include user-controlled text-on-demand in small chunks and placed in proximity to the physical components. In observation sessions where students experienced both forms of introductory text, this text-on-demand was always preferred.

In all simulations, the initial Controls view shows a particularly simple and illuminating case, and tick boxes are unchecked. This aims to avoid overwhelming students and encourages exploration and sense-making. Simulations that allow students to take data include a "Clear measurements" button, so that students can reset the simulation. This creates a safe and non-threatening environment for exploration.

Simulation controls that are difficult to activate lead to a focus on the control and user frustration. Fitts's Law (Fitts, 1954) states that the time needed to activate a control is related to its size and positioning. In earlier versions of the simulations, controls could only be activated by selecting the actual control. In the observation sessions, some students clicked on the text labels for radio buttons and tick boxes instead of the actual controls. Thus, all controls were revised to be clickable via the associated text as well as the actual control. The recently developed HTML5 simulations have a large invisible active area around each control and more widely spaced controls, to ensure controls are easily activated on smaller screens and for touchscreen use. This design was developed using student observation sessions with students working with simulations on tablet-based devices. In the original layout, in the observation sessions students sometimes struggled to activate a control and required multiple attempts to do this.

From the in-class use of the *Interferometer experiments with photons, particles and waves* simulation, some negative student comments pertained to controls becoming inactive while photons were fired through the experiment, and that this made taking data and comparisons between different inputs time-consuming. All simulations in which data is collected were revised so that controls remain active when the input is sent through the experiment in continuous stream mode. In response to student suggestions for improvement to speed up data collection, a "Fast forward 50 counts" button was added to facilitate gathering of large numbers of counts to all simulations where students can collect data.

6. Using simulations to perform virtual experiments

Quantum mechanics textbooks define quantities such as probabilities, expectation values, quantum-mechanical uncertainties and correlation coefficients for entangled particle pairs in terms of mathematical formulas, but often do not describe how these quantities would be determined experimentally using many measurements on identical input particles or particle pairs. This may lead to these quantities being perceived as abstract and far-removed from experiments. One of the key aims of many of the QuVis simulations is to allow students to experience how such quantities can be determined experimentally and to understand inherent statistical fluctuations. Ten of the QuVis simulations in the "New Quantum Curriculum sims collection" allow students to send particles or photons through experiments, and seven simulations show how the experimental quantities approach the theoretically predicted values in the limit of a large number of measurements.

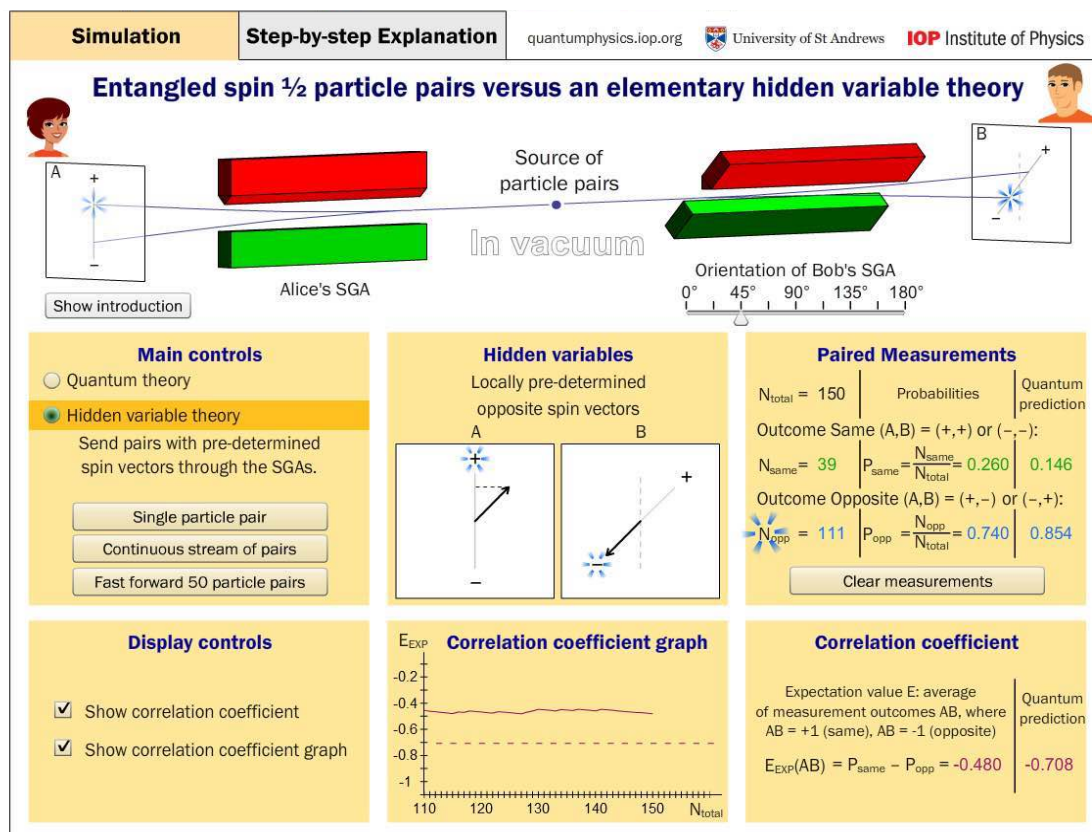

Figure 5. A screenshot of the *Entangled spin $\frac{1}{2}$ particle pairs versus an elementary hidden variable theory* simulation. In this simulation, students can assess whether a simple hidden variable theory agrees with measurement outcomes predicted by quantum theory.

For example, the *Entangled spin $\frac{1}{2}$ particle pairs versus an elementary hidden variable theory* simulation (Figure 5) allows students to assess whether a simple hidden variable theory would agree with measurement outcomes predicted by quantum theory. The simulation shows a source of particle pairs in the middle of two Stern-Gerlach apparatuses, one of which can be rotated with respect to the other. The observers measure outcomes of + or – irrespective of orientation depending on whether the deflection is positive or negative along the measurement axis. When the main controls are set to “Quantum theory”, the particles pairs are entangled and always give opposite results when both Stern-Gerlach apparatuses have the same orientation. When the main controls are set to “Hidden variable theory”, the particles in the pair have pre-determined opposite spin vectors that are randomly oriented in space. By setting up different experimental configurations, students find that the two theories give different outcomes for some orientations of the second Stern-Gerlach apparatus. Hence the simulation allows students to deduce that this hidden variable theory must be incorrect.

7. Use of multiple representations

By using multiple representations to illustrate phenomena, interactive simulations can help students develop visual mental models and encourage them to make connections between different representations. Many of the QuVissimulations aim to help students make connections between multiple representations. Simulations make use of physical, mathematical and graphical representations, with consistent representations across different simulations.

In the *Entangled spin $\frac{1}{2}$ particle pairs versus an elementary hidden variable theory* simulation (Figure 5), flashes are used to help students make connections between the measurement outcomes on the screens, the hidden variables (the opposite spin vectors) and the number of particle pairs with same and opposite measurement outcomes. Flashes are used in similar ways in all simulations which allow students to take data (see also Figure 4). Colour is used to help students differentiate between quantities, such as the detections by detectors 1 and 2 in Figure 4 and the same and opposite measurement outcomes in Figure 5. Colour is also used to help students make connections between experimental outcomes, calculated quantities and graphs. In Figure 5, colour is used to link the number of opposite measurement outcomes and the probability for the

outcomes to be opposite, and to link the mathematical and graphical representations of the correlation coefficient.

8. Optimizing simulation activities

Strongly guided activities can inhibit students' exploration and reduce interaction with a simulation in terms of the number of controls used and total exploration time (Adams 2008c). Studies have shown that getting students to freely explore a simulation before working on an activity can encourage exploration and sense-making (Moore 2013).

The QuVis simulation activities aim to scaffold students' exploration by progressing from simpler to more complex situations. They ask students to compare and contrast classical and quantum behaviour, make sense of their observations, calculate displayed quantities and make connections between multiple representations. Adding questions that explicitly ask students to compare their calculations with their observations in the simulation helps them make connections between mathematical and visual representations (Kohnle 2013).

For the "New Quantum curriculum sims" collection, all activities start with a question asking students to have a play with the simulation for a few minutes, getting to understand the controls and displays, and to note down a few things about the controls and displayed quantities they have found out. Success on the activity as a whole was investigated depending on whether or not students have completed this question. This analysis used student responses to the *Quantum key distribution with entangled spin $\frac{1}{2}$ particles* (quantum cryptography) simulation used in an introductory quantum physics course taken by students in their first or second year at the University of St Andrews. The activity was given as an online homework assignment, and did not form part of the course assessment. There were 79 students in the class, and 65 of them completed the assignment. Students had not encountered quantum cryptography in class, and thus they were learning new material using the simulation.

Student responses to each of the activity questions were marked as correct, partially correct, incorrect or unanswered. The activity consisted of 8 questions in total. The analysis compared the distribution of fully correct responses to questions 2 to 8 (so excluding question 1 asking students to freely explore the simulation and note down things they have found out) for those students that had completed question 1 (N=52) with those that had not answered this question 1 (N=13). Students that had not completed question 1 had completed the other questions, excepting three students who did not complete the final question of the activity. On average, students completing question 1 had 5.2 other questions correct, students not completing question 1 had 4.1 other questions correct. Thus, there is a difference in the mean number of questions answered correctly, with on average greater success on the rest of the activity for those students that had answered question 1. An independent t-test showed that the difference in questions answered correctly is statistically significant between the two groups ($t=2.634$, $df=63$, $p=0.011$, two-tailed). The mean difference of 0.93 is of medium size as measured by Cohen's $d=0.63$ (the mean difference divided by the average standard deviation).

This result only demonstrates a correlation, not a causal relationship, between answering question 1 and success on the rest of the activity, and this only for a single study. Further studies are planned to assess the impact of asking students to first explore a simulation freely on sense-making and success in achieving the learning goals.

9. Conclusions and Outlook

Research-based interactive simulations can address challenges of quantum mechanics instruction through user agency, implicit scaffolding, feedback on actions allowing trial-and-error exploration and the use of multiple representations. An iterative development process informed by student feedback from individual sessions and in-class trials is key to developing educationally effective resources. Initial evidence from observation sessions and in-class trials shows that QuVis simulations are helping students learn quantum mechanics topics, including topics such as entanglement and hidden variables at the introductory level that are more commonly discussed at the advanced level. Further evaluation studies at multiple institutions are planned to ensure simulations are useful to students from a wide range of backgrounds.

Current work aims to extend the QuVisHTML5 collection, both in terms of redesigning and recoding old simulations, as well as developing new simulations. Future development will include amongst other topics more simulations on quantum information processing and single photon experiments, as well as a larger collection of simulations suitable for the school level. Future work will aim to make simulations more engaging by including game-like elements aligned with learning goals. Future development will also include

more open and exploratory activities, including intrinsically collaborative activities that require students to bring together their individual contributions.

Acknowledgements

The author thanks the outstanding undergraduate students who coded the majority of simulations, all students taking part in the observation sessions and the in-class trials, and instructors that trialled simulations in their courses. The QuVis website has a full list of students and staff members that have been involved in the development and evaluation of simulations. The author thanks the UK Institute of Physics, the UK Higher Education Academy and the University of St Andrews for funding the QuVis project.

References

- Adams, W. L., Reid, S., LeMaster, R., McKagan, S. B., Perkins, K. K., Dubson, M. and Wieman C. E. (2008a). A Study of Educational Simulations Part I - Engagement and Learning, *Journal of Interactive Learning Research* **19**, 397-419.
- Adams, W. L., Reid, S., LeMaster, R., McKagan, S. B., Perkins, K. K., Dubson, M. and Wieman C. E. (2008b). A Study of Educational Simulations Part II - Interface Design, *Journal of Interactive Learning Research* **19**, 551-577.
- Adams, W. K., Paulson, A. and Wieman, C. E. (2008c). What Levels of Guidance Promote Engaged Exploration with Interactive Simulations? *2008 PERC Proceedings* (edited by C. Henderson and M. Sabella). AIP Conference Proceedings 1064, 59-62.
- Baily, C. and Finkelstein, N. D. (2010). Teaching and understanding of quantum interpretations in modern physics courses, *Phys. Rev. ST Phys. Educ. Res.* **6**, 010101-1 to 11.
- Beck, M. (2012). *Quantum Mechanics: Theory and Experiment*, Oxford University Press, New York, USA.
- Belloni, M., Christian, W. and Cox, A. J. (2006). *Physlet Quantum Physics: An Interactive Introduction*, Pearson Prentice Hall, Upper Saddle River, NJ, USA.
- Cataloglu, E. and Robinett, R. W. (2002). Testing the development of student conceptual and visualization understanding in quantum mechanics through the undergraduate career, *Am. J. Phys.* **70**, 238-251.
- Chen, Z. and Gladding, G. (2014). How to make a good animation: A grounded cognition model of how visual representation design affects the construction of abstract physics knowledge, *Phys. Rev. ST Phys. Educ. Res.* **10**, 010111-1 to 24.
- Clark, R. C. and Mayer, R. E. (2011). *E-Learning and the science of instruction*, John Wiley, San Francisco, USA.
- Fitts, P.M. (1954). The information capacity of the human motor system in controlling the amplitude of movement, *Journal of Experimental Psychology* **47**, 381-391.
- Kohnle, A., Douglass, M., Edwards, T. J., Gillies, A. D., Hooley, C. A. and Sinclair, B. D. (2010). Developing and evaluating animations for teaching quantum mechanics concepts, *Eur. J. Phys.* **31**, 1441-1455.
- Kohnle, A., Cassettari, D., Edwards, T. J., Ferguson, C., Gillies, A. D., Hooley, C. A., Korolkova, N., Llama, J. and Sinclair, B. D. (2012). A new multimedia resource for teaching quantum mechanics concepts, *Am. J. Phys.* **80**, 148-153.
- Kohnle, A., Baily, C., Hooley, C. A. and Torrance, B. (2013). Optimization of simulations and activities for a new introductory quantum mechanics curriculum, *2013 PERC Proceedings [Portland, OR, July 17-18, 2013]*, edited by P. V. Engelhardt, A. D. Churukian, and D. L. Jones, 209-212.
- Kohnle, A., Bozhinova, I., Browne, D., Everitt, M., Fomins, A., Kok, P., Kulaitis, G., Prokopas, M., Raine, D. and Swinbank, E. (2014). A new introductory quantum mechanics curriculum, *Eur. J. Phys.* **35**, 015001-1 to 9.
- López, V. and Pintó, R. (2013). Students' difficulties when reading interactive scientific visual representations. *Proceedings of the ESERA Conference*, European Science Education Research Association, Strand 4 Digital resources for science teaching and learning, 46-56.

- Malgieri, M., Onorato P. and De Ambrosis, A. (2014). Teaching quantum physics by the sum over paths approach and GeoGebra simulations, *Eur. J. Phys.***35**, 055024-1 to 21.
- McKagan, S. B., Perkins, K. K., Dubson, M., Malley, C., Reid, S., LeMaster, R. and Wieman, C. E. (2008). Developing and Researching PhET simulations for Teaching Quantum Mechanics, *Am. J. Phys.***76**, 406-417
- Michelini, M., Ragazzon, R., Santi L. and Stefanel, A. (2000). Proposal for quantum physics in secondary school, *Phys. Educ.***35**, 406-410.
- Moore, E. B., Herzog, T. A. and Perkins, K. K. (2013). Interactive simulations as implicit support for guided-inquiry, *Chem. Educ. Res. Pract.***14**, 257-268.
- Podolefsky, N. S., Perkins, K. K. and Adams, W. K (2010). Factors promoting engaged exploration with computer simulations, *Phys. Rev. ST Phys. Educ. Res.***6**, 020117-1 to 11.
- Saffer D. (2010). *Designing for Interaction*, New Riders, Berkeley, USA.
- Scarani, V., Chua L. and Liu, S. Y. (2010). *Six Quantum Pieces: A First Course In Quantum Physics*, World Scientific Publishing, Singapore.
- Singh, C. (2001). Student understanding of quantum mechanics, *Am. J. Phys.***69**, 885–896.
- Wittmann, M. C., Morgan, J. T. and Bao, L. (2005). Addressing student models of energy loss in quantum tunnelling, *Eur. J. Phys.***26**, 939-950.
- Zhu, G. and Singh, C. (2012). Improving students' understanding of quantum measurement. I. Investigation of difficulties, *Phys. Rev. ST Phys. Educ. Res.***8**, 010117-1 to 8.

Affiliation and address information

Antje Kohnle
School of Physics and Astronomy
University of St Andrews
North Haugh
St Andrews, KY16 9SS, United Kingdom
email: ak81@st-andrews.ac.uk

Supporting Teachers Use and Assessment of Inquiry Based Science Education in Classroom Practice

Eilish McLoughlin, Odilla Finlayson

Centre for the Advancement of Science and Mathematics Teaching and Learning (CASTeL), Dublin City University, Ireland

Abstract

Inquiry-Based Science Education (IBSE) has been the focus of many national and international programmes and projects in recent years as Inquiry based teaching methods have been suggested as a way to encourage and motivate students in science. The pan-European ESTABLISH [1] (2010-2014) FP7-funded project has developed a framework for teacher education in IBSE that has been adopted across eleven European countries. The national teacher education programmes (TEPs) implemented different models depending on their own educational and cultural contexts but all incorporated the suite of 18 IBSE teaching and learning materials (Units) which had been collated and developed by the consortium partners for this purpose. The implementation of the ESTABLISH TEPs with pre-service and in-service teachers has been shown to have a positive impact on the participating teacher's attitudes and understanding of IBSE, as well as their integration into classroom practice. However, for many students and teachers, assessment drives the activities in a classroom. Moreover, if something is assessed, then it is more highly valued, by teachers and students alike; hence, if the competencies and skills that are developed in IBSE remain un-assessed, then the development of these skills and competencies will always be secondary to recall and routine problem solving. The pan-European FP7-funded project SAILS [2] (2012-2015) was focused on addressing this issue by providing TEPs to support teachers in using IBSE as well as implementing appropriate assessment strategies to assess the skills and competencies that are developed through inquiry. This paper will outline the concept and rationale of these two projects and will highlight the need for supporting teachers not just to use IBSE but also be confident and competent in assessing student learning in the IBSE classroom.

1. Introduction

Education and training have been central to the Lisbon agenda for growth and jobs and again take primary focus supporting the “smart growth” priority of the growth strategy for 2010-2020 [3]. More than ever, Europe's success in global competition is dependent on effective partnerships between business and academia to ensure that education delivers “high-level and highly valued skills”, as presented in the 2010 EC Working document on the European 2020 Flagship Initiative [4]. In addition, the European Framework for Key Competencies for Lifelong Learning [5] identifies and defines the following eight key competences necessary for personal fulfilment, active citizenship, social inclusion and employability in a knowledge society and recommends that initial education and training should support their development:

- Communication in the mother tongue;
- Communication in foreign languages;
- Mathematical competence and basic competences in science and technology;
- Digital competence;
- Learning to learn;
- Social and civic competences;
- Sense of initiative and entrepreneurship;
- Cultural awareness and expression.

Employers have also stated that they need a workforce fully equipped with skills beyond the basics of reading, writing and arithmetic to grow their businesses, including:

- Critical thinking and problem solving: the ability to make decisions, solve problems and take action as appropriate.
- Effective communication: the ability to synthesize and transmit ideas in both written and oral formats.
- Collaboration: the ability to work effectively with others, including those from diverse groups and with opposing points of view.
- Creativity and innovation: the ability to see what's not there and make something happen [6]

However, many employers have identified that “high school graduates were ‘deficient’ in problem solving and critical thinking” [7]. In addition to the above, there has been a recent trend across the EU towards competence-based teaching and learning and a learning outcome approach [8], resulting in significant changes occurring at school curricula level in traditional subject areas such as science. These curricula are now being treated in more engaging cross-curricular ways, with greater emphasis being placed on developing skills and positive attitudes towards science alongside knowledge and with increased use of “real-life” applications to provide appealing learning contexts.

2. Inquiry Based Science Education

Crucial to the development of key competencies in young people is their engagement in the education process. Methodologies such as inquiry-based science education (IBSE) have been highlighted as having the potential to increase student engagement in science at primary and second level and provide such development opportunities [9, 10]. Recommendations from these international reports identify the need for “engaging curricula to tackle the issue of out-of date and irrelevant contexts and to enable teachers to develop their knowledge and pedagogical skills”.

The global network of science academies [11] also supports the reform of science education on a global scale by encouraging hands-on inquiry-based learning (IBSE), especially in primary and secondary schools – where they define IBSE as comprising of “experiences that enable students to develop an understanding about the scientific aspects of the world around through the development and use inquiry skills.” In their 2006 Working Group on the International Collaboration in the Evaluation of IBSE programs report [12] they discuss IBSE in practice and conclude that, while there is no single model of IBSE, there are recognised features of the classroom activities that indicate IBSE is taking place, such as students will be:

- *“engaged in observation and, where possible, handling and manipulating real objects;*
- *pursuing questions which they have identified as their own even if introduced by the teacher;*
- *taking part in planning investigations with appropriate controls to answer specific questions;*
- *using and developing skills of gathering data directly by observation or measurement and by using secondary sources;*
- *using and developing skills of organising and interpreting data, reasoning, proposing explanations, making predictions based on what they think or find out;*
- *working collaboratively with others, communicating their own ideas and considering others’ ideas;*
- *expressing themselves using appropriate scientific terms and representations in writing and talk;*
- *engaging in lively public discussions in defence of their work and explanations;*
- *applying their learning in real-life contexts;*
- *reflecting self-critically about the processes and outcomes of their inquiries.”*

The European Commission, having identified IBSE as a desirable methodology to implement in classrooms across Europe to engage young people in science and mathematics and develop skills and competencies to cope with the challenges for a changing world, have funded a number of projects in IBSE such as ESTABLISH and SAILS to support teachers in adopting an IBSE methodology in their classrooms.

3. Supporting teachers in using IBSE

The overall objective of the ESTABLISH project was to facilitate and implement an inquiry-based approach to science education for second level students (age 12-18 years). To do this the ESTABLISH project was focused on creating authentic learning environments for science education by bringing together and involving all the key communities in second level science education, including science teachers and educators, the scientific and industrial communities, the young people and their parents, the policy makers responsible for science curriculum and assessment and the science education research community. This collaboration has informed the development of educational programmes for both in-service and pre-service teachers (ESTABLISH Teacher Education Programmes) as well as the project's IBSE teaching and learning materials (ESTABLISH Units).

To achieve the project's aims ESTABLISH adopted the definition of inquiry as the "intentional process of diagnosing problems, critiquing experiments, and distinguishing alternative, planning investigations, research conjectures, searching for information, constructing models, debating with peers, and forming coherent arguments" [13]. The ESTABLISH consortium members collaborated with local actors to develop and pilot IBSE teaching and learning materials and developed 18 substantial IBSE teaching and learning units that encompass an extensive range of science activities that have been proven to be suitable for using in inquiry teaching and learning across the participating eleven countries (Ireland, Germany, Sweden, Cyprus, Czech Republic, Poland, Slovakia, Malta, Netherlands, Estonia and Italy). A list of the topics and disciplines of these 18 units is given in Table 1.

Table 1. List of ESTABLISH IBSE Teaching and Learning Units

Physics	Chemistry	Biology	Integrated Sciences
Sound	Exploring Holes	Disability	Forensic science
Heating & Cooling - Designing a low energy home	Chitosan – Fatmagnet?	Blood donation	Medical imaging
	Cosmetics	Ecology	Renewable energy
Direct current electricity	Chemical Care	Water in the Life of man	Photochemistry
Light	Plastics and Plastic Waste		Photosynthesis

Over 1300 in-service teachers from across the eleven participating countries participated in ESTABLISH TEPs with a further ~ 650 pre-service teachers involved in workshops as part of their initial teacher education. An important outcome of the project has been the development of a framework for IBSE Teacher Education Programmes (TEPs) which provides a flexible and comparable description of TEPs which cater for in-service and pre-service teacher education delivered by face-to-face and online strategies across a variety of cultural, educational and disciplinary contexts. Key results from the project show that following the TEPs, the in-service teachers have increased their understanding of inquiry and their understanding of the roles of teacher and student in an inquiry classroom, with the biggest increase by those who classify themselves as beginners in IBSE.

4. Supporting teachers in assessing IBSE

The SAILS - Strategies for Assessment of Inquiry-based Learning in Science - project (2012-2015) was funded by EU 7th Framework Programme to support teachers in adopting inquiry-based science education (IBSE) at the secondary level. The SAILS project has three main objectives: (1) to enhance existing IBSE teaching and learning materials by incorporating inquiry assessment strategies and frameworks; (2) to partner with teachers to identify and implement assessment strategies and frameworks to evaluate key IBSE skills and competences in the classroom; and (3) to provide teacher education programmes in IBSE and promote a self-sustaining model to encourage teachers to share experiences and practice of inquiry approaches to teaching, learning and assessment - by supporting a community of practice. The project consortium consists of fourteen partner organisations, including universities, small companies and a multi-national organisation, from across twelve European countries (Belgium, Denmark, Germany, Greece, Hungary, Ireland, Poland, Portugal, Slovakia, Sweden, Turkey and the United Kingdom).

The SAILS project also adopted the approach that inquiry was defined as the “intentional process of diagnosing problems, critiquing experiments, and distinguishing alternatives, planning investigations, researching conjectures, searching for information, constructing models, debating with peers, and forming coherent arguments” [13]. Thus it requires more of the learner than simply commanding and recalling scientific knowledge. The main focus of the SAILS project was to equip teachers across Europe with assessment strategies to evaluate a number of key IBSE skills and competencies developed in the classroom, when an IBSE methodology is adopted.

SAILS adopted the approach of extending existing IBSE curricula and Teacher Education (TE) programmes, to motivate and support IBSE practitioners in the classroom, and in addition, to develop a systematic approach to the assessment of IBSE skills, as depicted in the SAILS model in Figure 1.

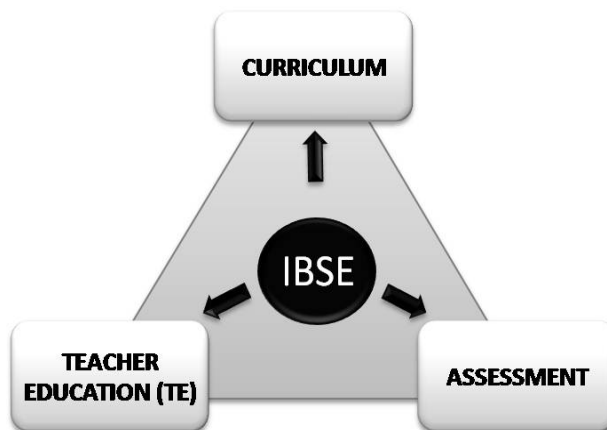

Figure 1. The role of curriculum, teacher education and assessment in the improved model of IBSE advocated by SAILS.

A key aspect of the SAILS project involved the selection of appropriate teaching and learning materials that were good examples of inquiry. These materials were then critiqued to identify the main inquiry skill(s) that could be developed through these activities. It is clear that development of inquiry skills is a process that occurs over time and so it was necessary to develop materials to encompass a range of inquiry skills. Additionally, opportunities for collaborative group work and classroom dialogue were identified. These materials were further developed to present models and materials for the assessment of the inquiry skills. Three different areas for assessment were identified, namely assessment of conceptual knowledge; assessment of reasoning processes and assessment of inquiry skills. Informed by expertise within the group, and literature, opportunities for assessment were identified in the activities; however, it was clear that teachers could not trial all aspects of these suggestions. Draft Units were prepared that presented the inquiry approach and offered a selection of opportunities for assessment of the inquiry skills, along with criteria proposed for that assessment. Pilot teachers whom were experienced in IBSE were selected in each country to trial these draft units in their classrooms. The teachers recorded their experiences in the form of Case Studies which outlined the practice of the assessment, the criteria used in the assessment and their planned follow up as a consequence of that assessment. The evaluation of the draft units and case studies was based on trialling inquiry and assessment materials in at least three different countries. The final stage of the project involved collating and presenting the final inquiry and assessment materials developed in 20 Sails Units, as listed in Table 2. This overall approach adopted by project has also led to the development of the SAILS Framework for Assessment of Inquiry Skills, which is a very useful resource for both teachers and teacher educators.

Table 2. List of SAILS IBSE and Assessment Units

Physics		Chemistry		Biology	
lower level	upper level	lower level	upper level	lower level	upper level
Speed	Ultraviolet radiation	Which is the Best Fuel?	Household vs natural environment	Food labels	Plant nutrition
Light	Up there... how is it?	Reaction rates		Wood lice	Natural selection
Electricity		Acids, bases, salts	Polymers- Properties of Plastics	Sports nutrition	
Floating orange	Global warming	The probe of the pudding			
Collision of an egg		Black tide: Oil in the water			

In parallel to this process, the SAILS partners have developed national Teacher Education Programmes (TEPs), with both in-service and pre-service teachers, that offers education in IBSE methodologies and the assessment of IBSE practices. These programmes have been developed over a three stage design and implementation process so that the final TEPs that have been implemented in each country, in accordance with the SAILS Framework for TEPs, integrate the assessment of IBSE within teacher education in inquiry methodologies. The final impact of the SAILS TEPs on teachers will be collated and reported at the end of the project and made available through the project website.

5. Conclusions

To tackle this global challenge of encouraging and supporting teachers to implement an inquiry approach in the classroom requires a wholesome approach to teacher education that also addresses teachers confident and competent in assessing inquiry skills and competencies. The collaborative efforts of the ESTABLISH project have led to the development of appropriate TEPs in IBSE, for both in-service and pre-service teachers, that include context-rich learning environments for IBSE. The outcomes of the SAILS project is to further the impact of the ESTABLISH and other such IBSE projects, by extending the resources of these projects to include appropriate assessment strategies for IBSE. The core objective in the development of these materials is to prepare appropriate materials for use in TEPs with in-service and pre-service teachers. A key outcome of the SAILS project is the development of effective models for the implementation of TEPs for inquiry with integrated assessment which have been informed by trialling with several teacher cohort groups in each country. Further details on both of the impact and resources that are freely available from these two EU funded projects can be found on the ESTABLISH [1] and SAILS [2] project websites.

The continuous and collaborative engagement of researchers, educators and teachers in these two projects over a five year period, has resulted in increased national and international discussion on the importance of assessment of inquiry practice. However, further research needs to be carried out to carefully examine how best to support all science teachers in implementing IBSE and assessment of IBSE skills and competencies effectively in their classrooms.

Acknowledgements

The ESTABLISH project has received funding from the European Union's Seventh Framework Programme for research, technological development and demonstration under grant agreement no 244749. The ESTABLISH consortium involves the beneficiary organisations: Dublin City University (Coordinator), AG Education Services, Frederick University Cyprus, University of Umea, Jagiellonian University, Charles University, AcrossLimits, Univerzita Pavla Jozefa Safárika v Kosiciach, Tartu University, Palermo University, CMA, Martin Luther Universitaet Halle-Wittenberg, IPN Institute, Malmo University.

The SAILS project has received funding from the European Union's Seventh Framework Programme for research, technological development and demonstration under grant agreement no 289085. The SAILS consortium involves the beneficiary organisations: Dublin City University (Coordinator), Audiovisual Technologies, Informatics & Telecommunications, INTEL Research and Innovation Ireland Limited, Gottfried Wilhelm Leibniz Universität Hannover, Hacettepe University, Instituto de Educação da

Universidade de Lisboa, Jagiellonian University, King's College London, Kristianstad University, Malmö University, University of Piraeus Research Centre, University of Southern Denmark, University of Szeged, Univerzita Pavla Jozefa Safárika v Kosiciach.

References

- [1] ESTABLISH project [website]. Available: www.establish-fp7.eu [2015, 1 Apr 2015].
- [2] SAILS project [website]. Available: www.sails-project.eu [2015, 1 Apr 2015].
- [3] European Commission (EC). (2010). EUROPE 2020: A strategy for smart, sustainable and inclusive growth (COM(2010) 2010). Brussels: European Commission.
- [4] European Commission (EC). (2010). Europe 2020 Flagship Initiative Innovation Union (Communication SEC(2010) 1161). Brussels: European Commission.
- [5] European Parliament and Council. (2006). Recommendation of the European Parliament and of the Council on key competences for lifelong learning. Official Journal of the European Union, L 394, 10-18.
- [6] American Management Association. (2010). Critical Skills Survey: American Management Association.
- [7] Barth, P. (2009). What do we mean by 21st century skills?, American School Board Journal.
- [8] Commission of the European Communities (CEC). (2009). Key competences for a changing world: Progress towards the Lisbon objectives in Education and Training (Commission Staff working document SEC(2009) 1598 FIN). Brussels: Commission of the European Communities.
- [9] European Commission (EC), & High Level Group on Science Education. (2007). Science Education NOW: A Renewed Pedagogy for the Future of Europe (EUR 22845). Brussels: DG Research.
- [10] Osbourne, J., & Dillon, J. (2008). Science Education in Europe: Critical Reflections. London: King's College, London.
- [11] IAP. (2015). [website]. Available: <http://www.interacademies.net/> [2015, 26 JAN 2015].
- [12] Harlen, W., & Allende, J. (2006). IAP Report of the Working Group on the International Collaboration in the Evaluation of IBSE programs.
- [13] Linn, M. C., Davis E.A., & Bell, P. (2004). Internet Environments for Science Education. Mahwah, NJ.: Lawrence Erlbaum Associates.

Affiliation and address information

Eilish McLoughlin
 Centre for the Advancement of Science and Mathematics Teaching and Learning (CASTeL),
 Dublin City University, Ireland
 Email: eilish.mcloughlin@dcu.ie

Potentially Meaningful Teaching Units (PMTUS) in Physics Education

Marco Antonio Moreira

Instituto de Física, Federal University of Rio Grande do Sul (UFRGS), Brazil.

Abstract

The construction of a didactic sequence is proposed here based on learning theories, specially the meaningful learning one. Assuming that there is no teaching without learning, and that teaching is a means while learning is the goal, a sequence is proposed as a Potentially Meaningful Teaching Unit (PMTU). Steps for its construction are suggested, and examples are given.

Keywords:

meaningful learning; potentially meaningful teaching units; physics education.

1. Introduction: The classical model of teaching and learning

Teachers in school, it does not matter whether at elementary, high school or college level, present students knowledge they are supposed to master. Students copy such knowledge chunks as a kind of information to be learnt by heart, reproduced in evaluative situations, and quickly forgotten afterwards. This represents the classic model of teaching and learning, which is grounded in the teacher's narrative and in the student's rote learning.

Learning theories suggest different approaches, as well as research findings of basic research on teaching. However, neither the theories nor these findings reach the classrooms. It is not the case here to blame educational psychologists, educators, researchers, teachers, and students, however, it is a fact that the narrative model is accepted by everybody – students, teachers, parents, and society in general – as “the model” for teaching and that rote learning is “the learning model”.

Actually, as far as practice goes, it is an enormous loss of time.

2. A different model

This paper intends to contribute to change, at least partially, this situation by proposing the construction of Potentially Meaningful Teaching Units, which constitute theoretically based teaching and learning sequences aiming at meaningful learning – not rote/mechanical learning – and favoring applied research on teaching, that one directed to real classroom practices. Because meanings are in the persons (e.g., scientists, teachers, students) not in the things (e.g., instructional materials). For instance, there are no meaningful books or meaningful classes. But they might be potentially meaningful provided that they are logically well organized and that the learners have adequate previous knowledge.

3. To grasp the meanings

In a teaching and learning situation students must grasp the meanings accepted in the context of the subject matter. In a physics class, for example, the teacher presents meanings accepted in physics for concepts, propositions, procedures, and the student must grasp those meanings.

3.1 The grasping of meanings: a model

D.B. Gowin (1981) proposes a model for teaching episodes that seems to fit quite well what has been presented in the last paragraph. His model, from a meaningful learning perspective, can be represented as suggested in Figure 1. In this model, the teacher, who already masters those meanings that are accepted in the context of the subject matter, introduces these meanings to the students with potentially meaningful curriculum materials. This presentation, however, does not imply that the teacher narrates such contents. Quite the contrary, it implies that he/she brings about these meanings to the students by using various strategies so that students are led to perceive their relevance and eventually they come to display an intentionality to grasp and internalize the grasped meanings.

Student's intentionality

The student, in turn, should get back to the teacher the meanings he/she is grasping in reference to the knowledge conveyed by the educative materials of the curriculum. This type of student's attitude depends on his/her predisposition, on his/her intentionality to learn. In turn, this will depend on the students' perception of the relevance of the new knowledge, and on making sense of the learning tasks.

The aim of such interaction that involves teacher, student, and educative curriculum materials is the sharing of meanings. Until this goal is not achieved, until the student does not grasp the meanings as they are accepted in the context of the subject matter, and until he/she does not share them with the teacher, we cannot say that teaching has occurred. Teaching happens when students grasp meanings.

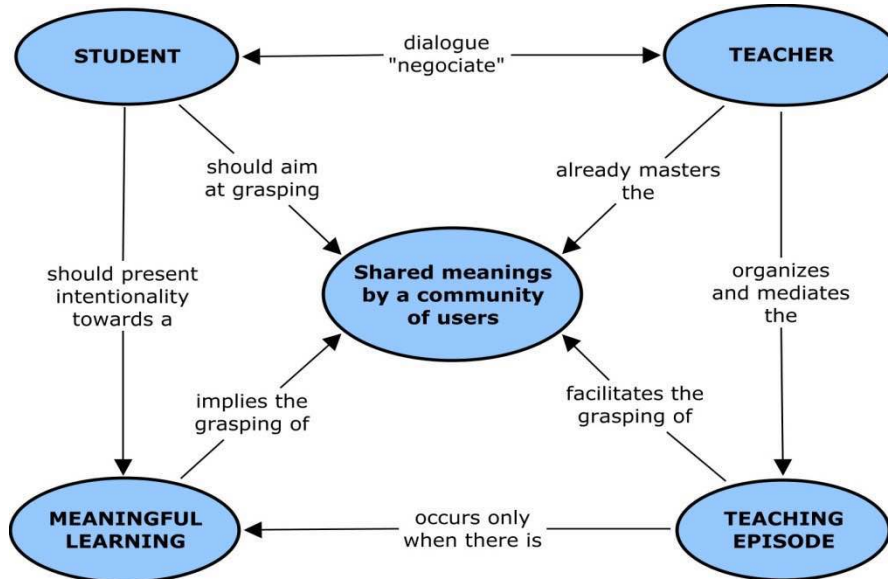

Figure 1. A schematic representation for the grasping of meanings in a teaching episode (adapted from Gowin, 1981)

4. Teaching episode

A teaching episode takes place when the student grasps the meanings the teacher intends him/her to grasp, which are those the community of users has already accepted for the specific context of a given teaching subject matter (Gowin, 1981). If there is no grasp of meanings, there is no teaching.

5. Student-centered teaching

Student-centered teaching is the one in which the teacher works as a mediator, and it is characterized by students who express themselves a lot while the teacher speaks just when needed. Letting students talk implies the use of strategies that favor interaction, discussion, negotiation of meanings among themselves, oral presentation of the product of their collaborative activities to the whole classroom, openness to criticism, and expression of their thoughts and suggestions concerning their peers' activities.

The student has to be active, instead of passive. He/she should learn how to interpret and to negotiate meanings. He/she must learn to be critical as well as to take critical responses to his/her work. Receiving uncritically the telling of the "good teacher" does not lead to critical meaningful learning, or to relevant learning; it does not guide students to learning how to learn.

6. Collaborative activities

Student-centered teaching implies not only a dialogic relationship, socially interactionist, between student and teacher, but also a student-to-student interaction. Teaching, then, has to be organized in such a way as to provide situations that students in small groups can solve collaboratively. It might be a project, a classic problem (exemplar), an open-ended problem, a concept map on a given topic, a Vee diagram on a research article, a lab practice, a critical analysis of a literary text, a dramatization. There are many possibilities, but it is important that in these activities the students cooperate, disagree, discuss, and look for a consensus.

The outcome of these collaborative activities should be presented to the whole classroom. In that occasion, members of the small groups submit their work to the criticisms of the other groups. This seems absolutely necessary. Criticism and argumentation are important. Self-awareness is important as well. What generally

results from this is that the group that has presented its work usually modifies its presentation. However, we have to consider that this kind of activity does not integrate the script of what means being a student, which has been developed by the students along many years of schooling. At start, students might show some resistance to small group collaborative activities, so that we should be patient and introduce them little by little.

7. Dialogue

When those meanings the students have externalized are not the ones the teacher intended them to grasp, which are those accepted in the context of the subject matter, the teacher should present them once more in a different way, so that students come to externalize them again. Dialogue, social interaction, and negotiation and sharing of meanings must be favored. In any educative event there should be some form of dialogue. Teachers cannot stay on and on speaking to themselves, or telling, while the student just listens and takes notes, or daydreams, or even takes a nap.

8. Social interaction & language

Well-known authors, such as Lev Vygotsky (1988) and Paulo Freire (1987, 1996) have emphasized the need for social interaction. The role of language here is crucial for this dialogue to happen. Neil Postman (1969), for example, points out that language is implied in any of our attempts to perceive reality (p. 99).

9. The role of the teacher

The learning situations proposed to the students should be developed and solved in a collaborative mode, and they have to be relevant, as well as to make sense for these students. It is precisely here that the role of the teacher is essential: it is the teacher that has to carefully select these situations. Furthermore, the teacher is the important mediator of the intense social interaction that results from these activities in a real classroom and/or in a virtual learning environment.

A student-centered teaching does not mean that the role of the teacher is understated. When the teacher does not play the role of narrator anymore, it does not indicate that there has been any decrease whatsoever in his/her relevance. On the contrary, as a mediator and organizer of learning situations that are student-centered, he/she becomes far more important than as a mere narrator.

10. The behaviorist evaluation.

Even when teachers and methodologies are constructivist, evaluation procedures, in general, end up having a behaviorist bias: students, parents, principals, lawyers want teachers to have objective written records – proofs – that show whether the student “knows” or “does not know” a given content or topic. As a matter of fact, that is just assessment, measurement, not evaluation. Evaluation is more than just measuring how many “right answers” the student is able to give.

11. Constructing potentially meaningful teaching units - pmtus

11.1 Goal

Such a constructing process aims at developing potentially meaningful teaching units to facilitate the occurrence of meaningful learning of specific declarative and/or procedural knowledge topics.

11.2 Philosophy

Teaching can only happens when learning occurs, and learning has to be meaningful; teaching is the means and meaningful learning is the end to be reached; teaching materials that aim at this type of learning have to be potentially meaningful.

11.3 Theoretical framework

It comprises the theory of meaningful learning of David Ausubel (1968, 2000), in classical and contemporary perspectives (Moreira, 2000, 2005, 2006; Moreira and Masini, 1982, 2006; Masini and Moreira, 2008; Valadares and Moreira, 2009), educating theories of Joseph D. Novak (1977) and D.B. Gowin (1981), social interactional theory of Lev Vygotsky (1987), conceptual fields theory of Gérard Vergnaud (1990; Moreira, 2004), mental models theory of Philip Johnson-Laird (1983), and the critical meaningful learning theory of M.A. Moreira (2005).

11.4 Principles

- Prior knowledge is the variable that most influences meaningful learning (Ausubel).

- Thoughts, feelings, and actions are integrated in the learner, and this integration is positive and constructive, when learning is meaningful (Novak).
- It is the learner's responsibility to decide to meaningfully learn a given knowledge chunk (Ausubel; Gowin).
- Advance organizers display/ show relatedness between new knowledge and prior knowledge (Ausubel; Moreira).
- Problem-situations add meaning to new knowledge (Vergnaud) and they should be developed to arise in the students the intentionality to learn meaningfully.
- Problem-situations can work as advance organizers.
- Problem-situations should be proposed in increasing complexity levels (Vergnaud).
- When facing a new/novel situation, the first step to solve it is to construct in the working memory a functional mental model that is structurally analogous to the given situation (Johnson-Laird).
- Progressive differentiation, integrative reconciliation, and consolidation should be considered when organizing teaching (Ausubel).
- Meaningful learning evaluation should happen as a search for evidences.
- Meaningful learning is progressive.
- The teacher's role is to provide carefully selected problem-situations, to organize his/her teaching, and to mediate the students' grasping of meanings (Vergnaud; Gowin).
- Language and social interaction are crucial to the grasping of meanings (Vygotsky; Gowin).
- A teaching event involves a triadic relation (Figure 2) among student, teacher, and teaching/educative materials aiming at leading the student to grasp and share meanings that are accepted in the context of a given teaching subject knowledge area (Gowin).
- This relation can also be quadratic when the computer is used as a learning mediator, and not just as an educational material (Figure 3).

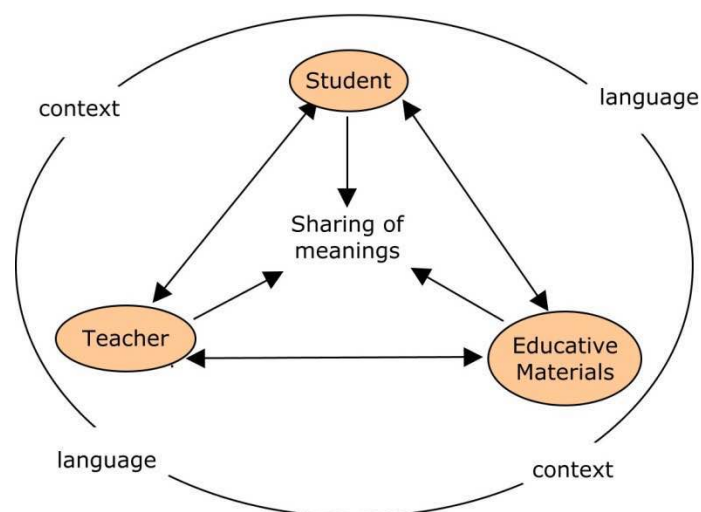

Figure 2. Gowin's triadic model (Moreira, 1993): Gowin sees a triadic relationship among Teacher, Educative Materials, and Student. To him, a teaching learning situation is characterized by a "negotiation of meanings" between student and teacher regarding pieces of knowledge conveyed by educative materials.

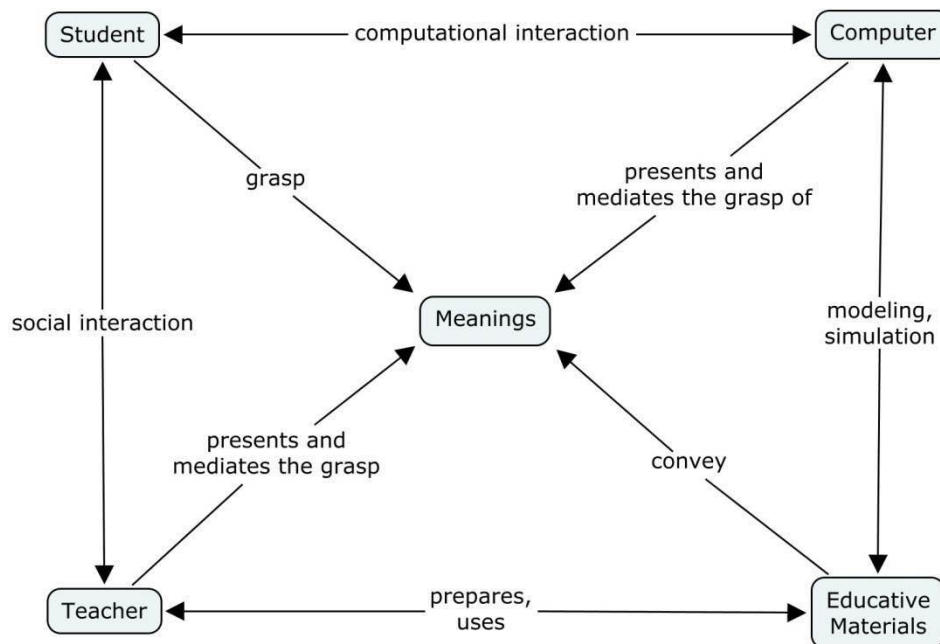

Figure 3. Gowin's model considering the computer also as learning mediator.

- Learning should be meaningful as well as critical, and not mechanical, rote (Moreira).
- Critical meaningful learning is favored by the search for answers (questioning), through the use of a diversity of materials and teaching strategies, and by disclaiming the narrative model in favor of a student-centered teaching, instead of focusing on the memorization of already known answers (Moreira).

11.5 Sequential aspects

Steps 1 and 2 of a PMTU

1. Define the topic to be approached by identifying the declarative and procedural aspects as accepted in the context of the teaching subject in which this topic is inserted.

2. Propose situation(s) – discussion, questionnaire, concept map, problem-situation(s) – that lead the student to externalize his/her prior knowledge, independently of being, or not, accepted within the context of the teaching subject, but that might be relevant to the meaningful learning of the topic (goal/objective) on the agenda that is being undertaken.

Step 3

3. Propose introductory level problem-situations that consider the student's prior knowledge so as to prepare him/her to the introduction of the knowledge items (declarative or procedural) to be taught; these problem-situations might involve, from the very beginning, the topic on the agenda though not with the goal of starting to teach it; such problem-situations should serve as advance organizers; these situations add meaning to the new knowledge, but, in order to achieve this, the student should perceive them as problems and should be able to mentally model them.

Mental models are functional to the learner and result from his/her perception and prior knowledge (invariant operators); these initial problem-situations can be proposed through computational simulations, demonstrations, videos, life problems, representations brought about by the media, classical problems from the subject matter, but they always have to be in the format of an accessible problem generating mode, that is, never just as an exercise of a routine application of an algorithm.

Step 4

4. Once initial situations have been carried out, introduce what is to be learned, taking into consideration the features of progressive differentiation, that is, starting from the most general and inclusive aspects to provide an introductory view of the whole, which means presenting an overview of the most important features of the teaching unit, but immediately followed by examples and by approaching quite specific aspects; teaching strategy might be, for instance, a short lecture followed by a small group collaborative activity, which, in turn, can be followed by a presentation or discussion activity by the large group;

Step 5

5. Next, the most general and structuring aspects (that is, what is intended to be taught) of the teaching unit content should be resumed with a new presentation (it can be another short oral lecture, a text, or the use of a computational resource), though, in a higher complexity level in relation to the first presentation; problem-situations should be proposed in an increasing level of complexity; new examples should be given, emphasizing differences and similarities in relation to situations and examples already presented, that is, promoting integrative reconciliation.

After this second presentation, a collaborative activity aiming at the students' social interaction, negotiation of meanings, with the teacher as mediator, should be proposed; such an activity might be problem solving, construction of a concept map or a V diagram, a lab experiment, a small project, however, it has to involve negotiation of meanings and teacher mediation;

Step 6

6. To conclude the unit, the process of progressive differentiation should be continued, summing up the most relevant features of the given content, though under an integrative perspective, that is, aiming at integrative reconciliation; this should be carried out through a new presentation of meanings in a brief oral lecture, the reading of a text, the use of a computational resource or an audio-visual program.

What matters here is not the strategy itself, but the way to handle the unit content; after this third presentation, new problem-situations should be solved at a higher complexity level than the previous ones; these situations should be solved in collaborative activities that afterwards will be presented and/or discussed in the large group with the mediation of the teacher;

Step 7

7. Learning evaluation according to PMTUs should occur along their implementation, recording everything that might be considered as evidence of the occurrence of meaningful learning of the content handled in class; furthermore, there should be an individual summative evaluation after the sixth step, in which situations implying understanding, grasping of meanings, and, ideally, a transferring skill should be proposed;

Such situations should be previously validated by teachers/professors with expertise in the given teaching subject; performance evaluation of the PMTUs student should be equally based both on the formative evaluation (situations, task collaboratively solved, teachers' records) and on the summative one;

Step 8

8. A PMTU will only be considered successful when the students' performance evaluation can provide evidences of meaningful learning (grasping of meanings, understanding, explaining skills, competence in applying his/her knowledge to solve problem-situations). Meaningful learning is progressive and mastery of a conceptual field is also progressive, thus, the emphasis must be on evidences, and not on final behaviors.

11.6 Transversal aspects

Throughout the steps, teaching materials and strategies have to be diversified, questioning has to be privileged in relation to ready-made answers, and dialogue together with critique should be favored.

As a learning task, in activities developed along the PMTUs, students might be asked to propose their own problem-situations in relation to a given topic.

Although the PMTU should emphasize collaborative activities, it can also include instances of individual activities.

11.7 Diagrams

In order to approach in a diverse way the structure of a PMTU and to exemplify diagrams, which can be useful in the proposed collaborative activities, two different types of diagrams are presented here.

V diagram

Figure 4 shows a V diagram (Gowin, 1981) to streamline the construction process of a Potentially Meaningful Teaching Unit.

Concept map

Figure 5 presents a concept map to represent in another way the construction of a Potentially Meaningful Teaching Unit.

Examples

PMTUs are being used to teach different topics in physics. Two examples are provided in Appendices 1 and

2, but they are being used in other fields such as immunology, in biology; equilibrium, in chemistry; equations of differences, in mathematics; ...

12. Findings

The purpose of this presentation is not to report research findings, though PMTUs have been already used in some research studies, in Brazil, specially in Professional Master's Degrees in Physics Teaching. In all cases, evidences of meaningful learning were found. However, the most important finding was motivation. Students were highly motivated with the methodology and with topics like particle physics and quantum mechanics.

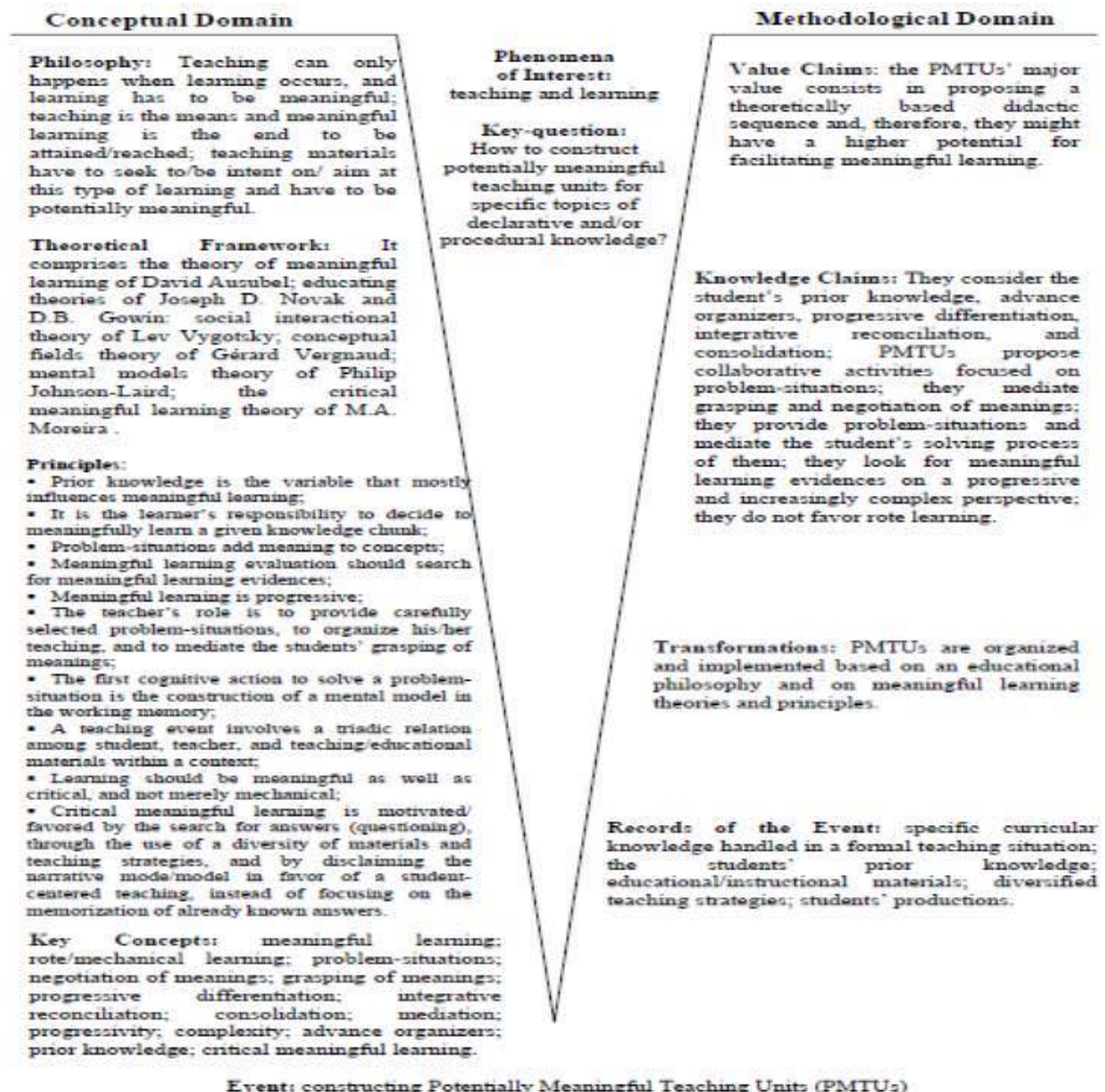

Figure 4. A V diagram for constructing a PMTU.

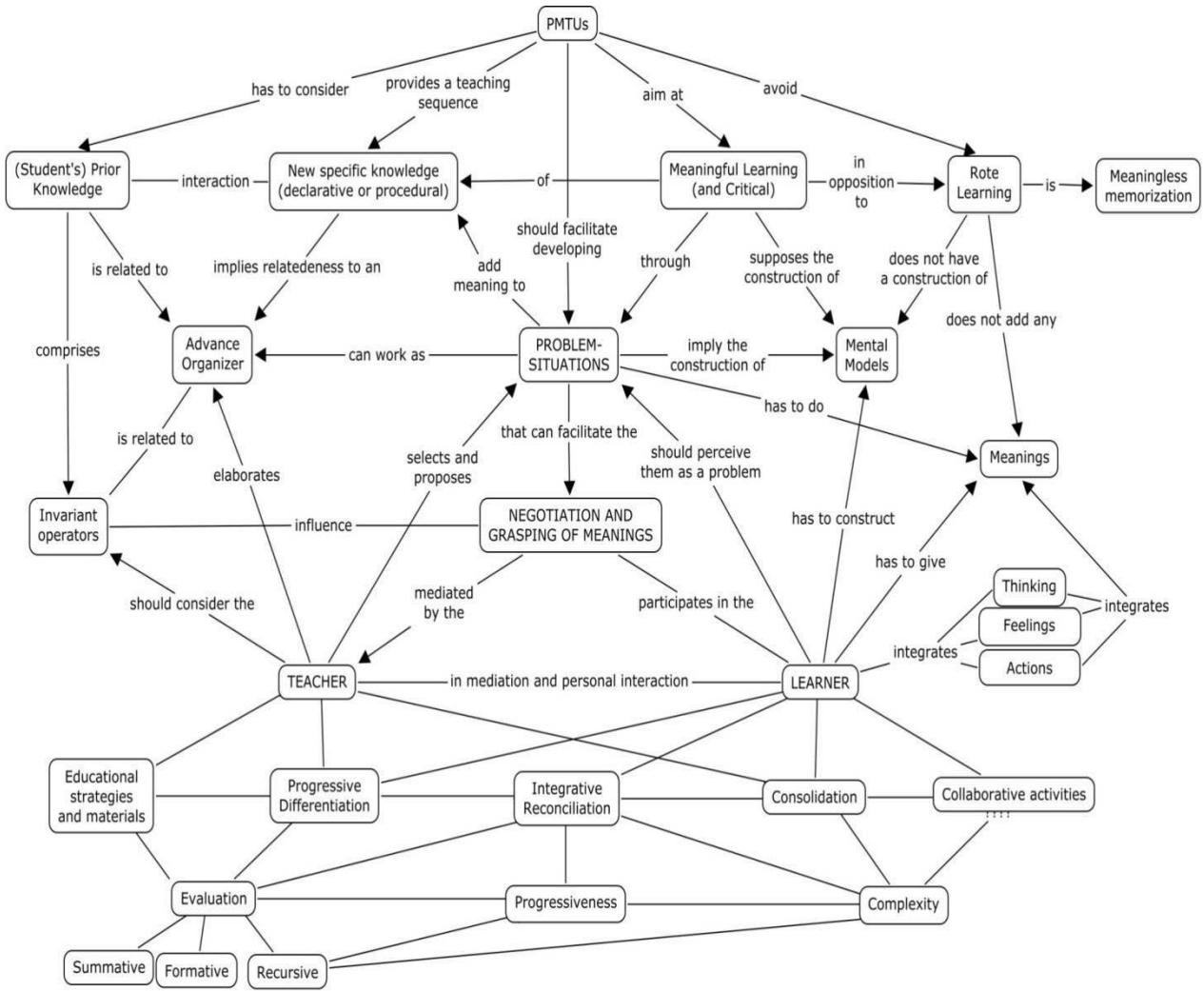

Figure 5. A concept map for the construction of a PMTU.

EXAMPLE 1**PROPOSAL OF A PMTU FOR TEACHING THE STANDARD MODEL OF PARTICLE PHYSICS**

M.A. Moreira

*Objective: to teach the Standard Model of Elementary Particles in High School***Sequence**

1. Initial situation: to build with the students a concept map about the subject matter; *firstly, ask students what constitutes this subject matter while writing on the chalk board what they are saying; next, mark the words students point out as those they believe to be the most relevant ones, then, place them in a hierarchic diagram (concept map); finally, ask each student to explain, in writing, with their own words, the map that was constructed in group; this individual explanation should be handed to the teacher at the end of this initial activity, which happens in the first class/meeting of this PMTU.*

2. Initial problem situations: *Examples a) If the nucleus of the atom is made of positively charged particles (protons), why doesn't it explode?; b) If negative and positive electric charges are attracted to one another, why aren't the electrons absorbed by the nucleus? ; c) If electrons and protons have mass, what is the role of gravitational interaction in the atom stability? ; d) What is the role of neutrons in the structure of the atom? e) Would it make any sense to think that basic atomic particles (electrons, protons, and neutrons) could be made of other even more elementary particles? These situations proposed here, which are based on the type of knowledge students have explicated in the prior class, should be discussed in the large group with teacher mediation and not necessarily should come as answers to the proposed problems.*

*As a next action, individual copies of the article *Partículas e interações* (Moreira, M.A., 2004, *Física na Escola*, v.5, n.2, pp.10-14), should be distributed among the students who should be given some time to read it and, after reading it, gather together in small groups (two to four participants) to build a table that should be analogous to Table 1, in the article, though simplified. After finishing this task, groups exchange their tables and each group corrects, comments and suggests changes in the other group's table. When each group gets back its table, it can modify it and hand the teacher this final version. This step of the PMTU will take two to three classes/meetings.*

Revision/review

3. Revision/review: *The class can start with a review/revision that can be a mini lecture/class on what has already been handled up to that point about the constitution of what the subject matter comprises, so as to open up room for the students' questions. Next, a 20 to 30 minute video on Elementary Particles (e.g., v. BBC. *The Big Bang Machine*. MVGroup) is presented. After the video presentation, the following articles are distributed among the students *Um mapa conceitual para partículas elementares* (Moreira, M.A., 1989, *Revista Brasileira de Ensino de Física*, v.11, pp. 114-129) and *Um mapa conceitual para interações fundamentais* (Moreira, M.A., 1990, *Enseñanza de las Ciencias*, v.8, n.2, pp.133-139) ,*

Another concept map

Students are, then, asked to read them and, in small groups, they draw a concept map of elementary particles and fundamental interactions, that is, a map that integrates, in a simplified way, the two maps presented in the articles. At least some of these concept maps are to be presented to the large group (in Power Point, on the chalk board, posters, or banners of paper and markers). Each group maps should be handed in to the teacher who will revise them and give them back to the students the next class, and the students, as they wish, can modify them so as to come up with their final version of their map. This activity will take two or three classes.

New problem-situation at a higher complexity level

4. New problem-situation at a higher complexity level: *To construct a V diagram of the Standard Model; to present a brief initial lecture with examples about what a V diagram is and on what constitutes its proposal,*

* Professor of Physics in the College Courses of Physics and of Modern and Contemporary Physics in the Professional Master's Degree Program in the Teaching of Physics at the Physics Institute, Federal University of Rio Grande do Sul (UFRGS), Brazil.

that is, what its role is; emphasize its epistemological nature; next, to distribute among students copies of the article “Um Vê epistemológico para a Física de Partículas (An epistemological V for Particle Physics)” (Moreira, M.A., 2010, Revista Chilena de Educación Científica, 9(1): 24-30).

A V Diagram

Ask students to construct, in small groups, a V diagram to the Standard Model, with the following basic question “How does the Standard Model of Elementary Particles show that Physics is a human construct and that all scientific knowledge is constructed? ”. Some of these diagrams should be presented to the large groups for discussion, and all of them should be handed in to the teacher for a qualitative analysis; as a result of this evaluation, the students can, if they want, reconstruct these diagrams. This activity will take two or three classes.

Individual summative evaluation

5. Individual Summative Evaluation: This activity will take one class and will have already been proposed to the students, thus, it will not come to them as a surprise; it proposes open questions in which the students can freely express their own understanding of the Standard Model; ask questions, propose a schematic representation or diagram that can show evidences of meaningful learning; any evaluation instrument based on “right or wrong” answers should be avoided.

Final integrative dialogic lecture class

6. Final Integrative Dialogic Lecture Class: At this point, it is time to retake the total content of the PMTUs, review the maps and the V diagram based on the articles studied in previous classes; it should be called attention to the descriptive and explanatory potential of the Standard Model in its relation to the constitution of matter; difficulties that were overcome by this theory, confirmed predictions, as well as still existing difficulties that can lead to changes or to its disclaim in favor of other better explaining one.

7. Learning evaluation in the PMTU: It should be based on what the students have produced, on classroom observations, and on the individual summative evaluation, whose weight/value should not be more than 50%.

8. Evaluation of the PMTU itself: It should be happen in relation to the obtained learning results; then, some activities should be reformulated, if necessary.

9. Total number of class hours: 9 to 12.

EXAMPLE 2**PROPOSAL OF A PMTU FOR TEACHING TOPICS OF QUANTUM MECHANICS AT HIGH SCHOOL**

Adriane Griebeler

Objective: *to facilitate the grasping of meanings of basic concepts in Quantum Mechanics in High School — quantization, uncertainty, quantum object, state, state superposition.*

Sequence

1. Initial situation: *students are motivated to develop a mind map for Quantum Physics (QP). In this map, they are free to establish associations among their knowledge chunks, representations, and cognitive actions based on a key word or on a central image. So, students feel at ease to establish relations between QP and other areas of Physics or/and their daily life and/or their social representations. Maps should be handed in to the teacher. In order to think about the given topic, students receive the lyrics and listen to the song Quanta, by Gilberto Gil. This activity will take one class.*

- a) *Where is QP applied? What does QP study?*
- b) *How does QP differ from the other areas of Physics (Mechanics, Thermodynamics, Electromagnetism, etc.)?*
- c) *What is a quantum of matter? And a quantum of energy?*
- d) *What is your opinion about the following adds/ headlines/titles (Magazine cut-outs or sites that talk about “Quantum therapies” brought by the teacher)*
- e) *Have you ever had any type of contact with the type of therapy that some people call “quantum”?*

These questions/situations should be discussed in the large group with the teacher as mediator, aiming at listening to the stands of the whole group and at stimulating/favoring interest on this subject, with no need to get to a final answer.

Next, an individual copy of the text Física Quântica para Todos (partially adapted from Nunes, A. L., 2007, Física Quântica para Todos, XVII SNEF.), available in the teaching support materials organized by the teacher. Students are given some time to read it, then they gather together in small groups to discuss it, and, afterwards, they can either sum it up, or create a diagram, or a drawing collaboratively. Products of this activity are handed to the teacher that will evaluate them qualitatively and will hand them back to allow students to redo their work considering the feedback comments they have received. This stage will take three classes.

Growing/Deepening/Strengthening knowledge

2. Growing/Deepening/Strengthening knowledge: *Concepts of quantization, quantum object, uncertainty, state, and superposition of states are handled here. These contents are presented in texts and slides, as large group discussions are favored. At the end of the introduction of these new contents, the cut-outs and adds are presented again to question students on the validity of what such material proposes, as well as their views on up to what extension these appropriations are legitimized by Physics. This stage takes three classes.*

New situation

3. New Situation: *These concepts are presented again in a video, “Mecânica Quântica” (Quantum Mechanics) produced by Discovery and accessed at <<http://www.youtube.com/watch?v=pCgR6kns5Mc>>. Next, students, in small groups, are asked to construct a concept map for Quantum Mechanics. Beforehand, there is a brief introductory lecture on how to build a concept map followed by some examples of it. Then, maps are constructed and exchanged among the groups to have them compared and to get peer suggestions. Some of them are presented to the large group. All maps are handed in to the teacher for evaluation. They*

· Graduate student of the Professional Master Degree Program in Physics Teaching , at the Federal University of Rio Grande do Sul, Brazil; Physics teacher at State High School Dr. Carlos Antonio Kluwe, Bagé, RS, Brazil.

will be qualitatively evaluated and, then, returned to the students that might reformulate them and hand them back to the teacher. This activity takes three classes.

Comparing maps

4. Comparing maps: *In the following class, there will be an activity involving the mind maps developed in the first class and the concept maps drawn the class before. A qualitative comparison between these two types of maps aiming at looking for aspects comprising alternative conceptions (misconceptions), or social representations, about Quantum Physics, which might have been presented in the mind maps of the first class and which might be absent in the concept maps. Such an aspect will be used to approach the subject again and to explain to the students that Quantum Physics cannot be used as a scientific foundation for topics those advertisements presented.*

Progressively differentiating

5. Progressively differentiating: *New problem-situations will be presented in relation to the concepts of quantization, quantum object, uncertainty, state, and superposition of states, mostly as images such as, for instance, the one of the Schrödinger Cat, which is available at <http://averomundo-jcm.blogspot.com/2009/10/gatos-e-virus.html>, and the development of a classroom newspaper will start with small articles, comic strips, and/or images on the studies topics. The teacher will mediate this newspaper development that, when finished, will be exhibited in school and available to the whole school community for reading. This activity will take three classes.*

Individual evaluation

6. Individual evaluation: *Individual evaluation will comprise open questions involving the key-concepts of the given unit. This activity will take one class.*

Final class and evaluation of the PMTU in the classroom

7. Final class and evaluation of the PMTU in the classroom: *This activity involves the analysis of the answers to the proposed questions of the individual evaluation. It will also include final integrating comments on the approached content. There is also an oral evaluation by the students about the teaching strategies that have been used and about their own learning. This activity will take one class. Students' comments will be recorded, if they comply with it.*

Evaluation of the PMTU by the teacher

8. Evaluation of the PMTU by the teacher: *Aiming at this, there will be a qualitative analysis by the teacher of the evidences he/she has, or not, perceived that might point out to the meaningful learning of the unit key concepts, both in the individual evaluation as in the participant observation, as well as in the classroom evaluation of the PMTU by the students in their last meeting.*

9. *Total number of class-hours of the PMTU: 16*

References

- Ausubel, D.P. (1968). *Educational psychology – a cognitive view*. New York: Holt, Rinehart and Winston. 685p.
- Ausubel, D.P. (2000). *The acquisition and retention of knowledge: a cognitive view*. Dordrecht: Kluwer Academic Publishers. 212p.
- Buzan, T. and Buzan, B. (1994). *The mind map book*. New York, NY: Dutton Books. 320p.
- Gowin, D.B. (1981). *Educating*. Ithaca, N.Y.: Cornell University Press. 210p.
- Johnson-Laird, P.N. (1983). *Mental models*. Cambridge, MA: Harvard University Press. 513p.
- Moreira, M.A. e Masini, E.F.S. (1982). *Aprendizagem significativa: a teoria de David Ausubel*. São Paulo: Editora Moraes. 112p.
- Moreira, M.A. e Masini, E.F.S. (2006). *Aprendizagem significativa: a teoria de David Ausubel*. São Paulo: Centauro Editora. 2ª ed. 111p.

- Moreira, M. A. (2002). *Aprendizaje significativo: teoría y práctica*. Madrid: Visor. 100p.
- Moreira, M. A. (2004). (Org.) *A teoria dos campos conceituais de Vergnaud, o ensino de ciências e a investigação nessa área*. Porto Alegre: Instituto de Física da UFRGS. 107p.
- Moreira, M.A. (2005). *Aprendizagem significativa crítica*. Porto Alegre: Instituto de Física da UFRGS. 45p.
- Moreira, M.A. (2006). *A teoria da aprendizagem significativa e sua implementação na sala de aula*. Brasília: Editora da UnB. 185p.
- Masini, E.A.F. e Moreira, M.A. (2008). *Aprendizagem significativa: condições para ocorrência e lacunas que levam ao comprometimento*. São Paulo: Vetor Editora. 295p.
- Novak, J. D. (1977). *A theory of education*. Ithaca, N.Y.: Cornell University Press. 295p.
- Novak, J.D. (1980). *Uma teoria de educação*. São Paulo: Pioneira. Tradução de M.A. Moreira do original *A theory of education*.
- Ontoria, A., De Luque, A. e Gómez, J.P.R. (2004). *Aprender com mapas mentais*. São Paulo: Madras. 168p.
- Valadares, J.A. e Moreira, M.A. (2009). *Aprendizagem significativa: sua fundamentação e implementação*. Coimbra: Edições Almedina. 132p.
- Vergnaud, G. (1990). La théorie des champs conceptuels. *Récherches en Didactique des Mathématiques*, 10(23): 133-170.
- Vygotsky, L. (1987). *Pensamento e linguagem*. São Paulo: Martins Fontes. 1ª Ed. Brasileira. 135p.
- Wilson, R. A and Keil, F. C. (2001). *The MIT Encyclopedia of the Cognitive Sciences*. Cambridge, MA: The MIT Press. 964p.

Affiliation and address information

Marco Antonio Moreira
Instituto de Física, UFRGS, Brasil
Caixa Postal 15051
91501-970 Porto Alegre, RS, Brasil
<http://moreira.if.ufrgs.br>
moreira@if.ufrgs.br

Thinking the Content for Physics Education Research and Practice

Laurence Viennot

PRES Sorbonne Paris Cité, Université Paris Diderot, LDAR

Abstract

Content analysis, it is unanimously agreed, is a fundamental component of physics education research. In this address I will discuss, on the basis of several examples, how various research standpoints resulted in different ways of reexamining - "reconstructing", or "spotlighting" - the content for teaching: student-led, teacher-led, responsive, proactive. In so doing, I will reconsider, in particular, the merits of "simplification". I will plead for a way of spotlighting the content for teaching that leaves room for the search for consistency and conceptual links, making these explicit, while respecting a constraint of accessibility. The examples of colour phenomena and the transfer of light will serve to illustrate this objective. The final discussion will bear on how students' intellectual satisfaction might thus be increased, and constitute a powerful incitement for them to engage with physics.

Keywords

Physics Education Research, Content analysis, Concept-Driven Interactive Pathway

1. Introduction

Everyone agrees that content analysis is a constitutive component of physics education research (PER). Since this research domain was first studied, in the seventies, a thorough examination of the content has been considered the first essential step of any investigation, in contrast with more general approaches to "science education". However, some collective works or meetings were launched in the nineties (Fensham *et al.* 1994, Bernardini *et al.* 1995) with the declared goal of stressing the crucial importance of reflecting upon the content that is to be taught, and conveyed an implicit criticism of contemporary research, seen as too generalist. Since then, several research programs, such as "Didactical structures" (Lijnse 1995, 2002), analyses of "Learning demand" (Leach & Scott 2002, 2003), or discussions on "Learning progressions" (Duschl *et al.* 2011), have converged in underlining that content analysis is central and, to a great extent, problematic, in physics education research. The influential movement of "Educational reconstruction" (Kattman *et al.* 1995, Kattman & Duit 1998) has strongly reinforced the idea that research in education for a scientific domain has to involve, as a basis, a "dialogue" between content analysis and a knowledge of students' common ideas. When it comes to discussing the appropriate conditions for teacher training, the strand of "Pedagogical Content Knowledge" makes ample room for the idea that the content should not be analyzed and discussed independently from the other components of the teachers' competence.

An idea serving as a (nearly) common denominator, in this respect, is that content should be known by researchers in PER, analyzed, elementarized, simplified, and reconstructed for teaching. In most of the diagrams proposed to schematize appropriate interactions in this process, a dialogue is suggested (double arrows) between "subject matter analysis" and "students' pre-scientific conceptions" – as in the case of "Educational reconstruction" (*ibid.*) - or equivalent wording is used. Although they are crucial factors, the roles of the teachers' level of acceptance of a reconstructed content and of their transforming trends (Pinto 2005) will not be broached in this paper. However, it seems clear – *a minima* - that, in the process of content reconstruction, formal accessibility is a constraint to be respected, in view not only of students but also of the teachers.

This paper addresses the following question, here limited to the domain of physics: to what extent and how was the content actually revisited in the frame of more or less recent investigations in physics education research? Far from being a complete account of all that has been produced in recent years, the objective of this paper is rather to sketch possible modalities for basing a content analysis on research in physics education. After an attempt to characterize a few of these modalities, an example of a "content driven interactive pathway" - about the absorption of light - will be presented to illustrate how a particular content can be revisited and "spotlighted" for teaching. With this last example, the process exemplified will borrow from several of the types previously characterized. All of these examples are intended to nourish a final

discussion about the stakes of revisiting the content for teaching, keeping in mind the general injunction to simplify while not losing sight of other essential aspects.

In this discussion, a pivotal idea will be that physics is a widely coherent set of theories, aiming at providing a unified and predictive description of the material world.

2. Responding to students' ideas: a mirroring effect (model 1a)

A first observation is that, in many of the suggestions for teaching made in the wake of research investigations, there was no particular stress or injunction to reconsider the content in a significant way. There was great progress, in such works, because they localized students' misunderstandings, ascribed mainly to "naïve ideas", "previous ideas", "alternative conceptions", "pre-scientific conceptions", etc., and ensured that these were given full attention, in particular via targeted questions. Such were the perspectives in Predict/Observe/Explain (White & Gunstone 1992) or Elicit, Confront, Resolve (Mc Dermott 1996). More recently, many strategies based on "cognitive conflicts" and/or "active learning" did not have a content mapping that was clearly distinct from the usual one, although some epistemic aspects were given a new emphasis (see the "epistemic axis" in Meheut & Psillos 2004). Thus, the status of models Vs the "material world" was one of the targets that several sequences about particle models had in common (Méheut & Chomat 1990, Vollebreght 1998), or problem-posing approaches (Lijnse 2002, Gil-Perez 2003) were intended notably to transform the teaching of some topics. But the conceptual structure of the content was not always substantially transformed, far from it.

In order to explain such stability, when observed, a model of the (non)transformation of the content analysis might be proposed (model 1a). It is intended to describe a stabilizing process, outlined in Figure 1. In this model, students' common ideas are central, as is widely recommended. Once identified, they generate some responses from the designers of research-based teaching learning sequences. But, before that step, it is worth noting that the "common ideas", to put it briefly, have been most often identified by contrast, and in one-on-one correspondence, with various items of the currently taught content. Let us call these items "references" for the observed common ideas. These references are extracted from the most common mapping of the content. Once the knowledge of common ideas has given birth to some targeted changes for teaching, there is a high probability that the "remedies" will be re-injected in the taught content more or less at the same place as the reference items, and be inserted in the initial global structure. This might explain why the content analyses underlying the design of some research based teaching sequences mirror the most current one.

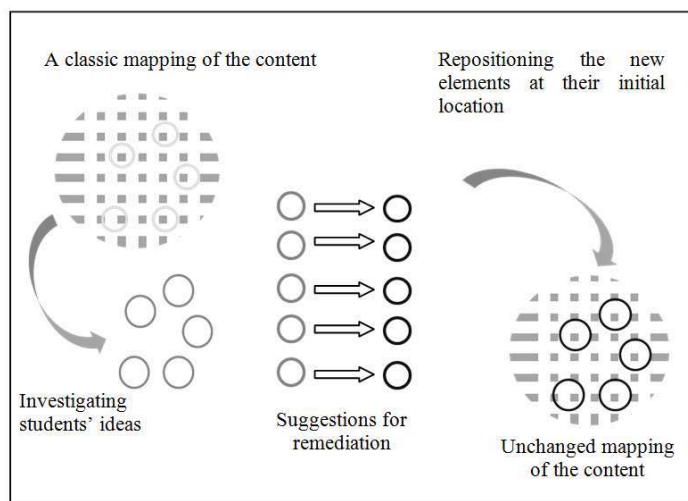

Figure 1. Responding to students' ideas: new taught content closely mirrors initial content. Black circles symbolize changes informed by knowledge of the students' ideas (grey circles).

For instance, in the first steps of a research investigation about electric circuits, the everyday meanings of current and the students' sequential reasoning were consensually identified as obstacles to a proper understanding of the content. In terms of content analysis, the suggestions for teaching made at that time were to emphasize such and such aspects, in particular via targeted questions or analogies, rather than to restructure the domain.

According to McDermott (1998, see also Shaffer & McDermott 1992), the recommended guiding process towards a comprehension of electric circuits involves a series of experiments from which students “draw inferences” concerning current and resistances. Students are said to “develop operational definitions through which they quantify the concepts of current, potential, potential difference and resistance”. Even if, via the finite lifetime of the battery, the idea is stressed that what is “used up” is energy and not current, the content analysis underlying this project remains very classical. Its essential novelty resides in the instructional strategy, which is already a very important and valuable first step.

By contrast, in some cases, the recommended conceptual goals may be seen as engaging the content more deeply. In a review about the *Learning and understanding of key concepts in electricity*, Duit and von Rhöneck (1998) recapitulate the state of affairs in this domain in 1998. Besides the recommended instructional strategies, often based on eliciting students’ ideas and more or less continuous views on conceptual change, they report briefly on various aspects of the “Student oriented structure of science content”. According to this review, two key concerns were: the differentiation between current flow and energy flow and the differentiation between intensity and tension. These aspects cannot really be presented as new, in terms of content analysis, as compared to the current courses in this domain. They were just presented as crucial aspects deserving emphasis. The third “key concern” mentioned in this review, i.e. a systemic view and the simultaneity of changes in a circuit, already pointed out by Härtel (1985, see also Closset 1983, Shipstone 1984), deserves a more nuanced comment, as it may be argued that this was really a novel idea, due to its transferrable aspect (Viennot 2001). This “key concern” announces the more radical type of change described below.

In passing, this first example – electric circuits – shows that the categorization put forward in this paper cannot be clear cut. Rather, it defines some extreme cases of how conceptual goals are redefined for teaching.

3. Responding to students’ ideas: a modified content

A few examples – particularly about elementary optical imaging and friction - introduce the following idea: some “responsive” aspects of teaching may, *de facto*, change the conceptual target itself. What might be seen merely as a “method,” intended to remedy students’ difficulties, in fact goes into the content deeply.

3.1 Optical imaging

Among the best known “common ideas” considered as obstacles in the teaching-learning of physics, are those accounted for with the model of “the travelling image” syndrome. The word “conception” seems appropriate here, to designate commonly observed question-and-answer pairs which are consistent with a view of optical imaging as the reception of an image (or something) travelling as a whole. In the eighties and nineties, several investigations (for instance Goldberg & McDermott 1987, Galili 1996) bore on situations like “a mask on a lens” and the frequent student prediction that it would make “a hole in the image”. Moreover, some criticisms were very soon formulated (Beaty 1987) concerning the possible role of the diagram currently used to find the position and size of an image formed by a thin convex lens (Figure 2).

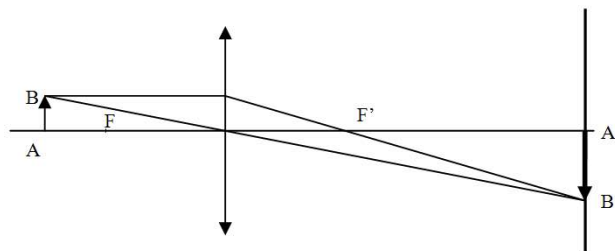

Figure 2. A classic diagram concerning optical imagery with a thin convex lens

The horizontal structure of this diagram and the restricted number of rays represented (rails for the images?) were seen as possible reinforcements for inappropriate views.

In this context, a different type of diagram was proposed and its impact was evaluated (Viennot & Kaminski 2006, see Figure 3).

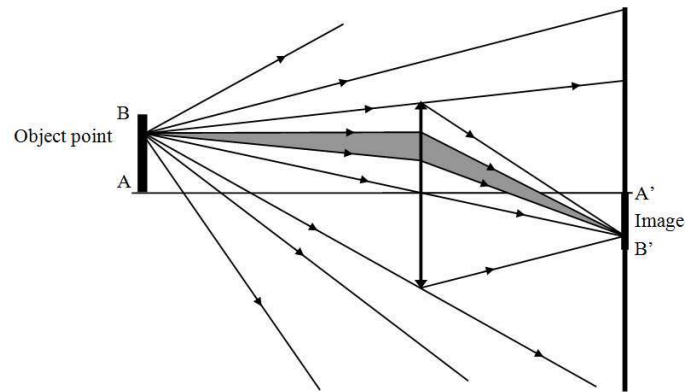

Figure 3. A diagram proposed to underline the process of image formation

A student's comment was particularly striking: "what was really new and decisive for me was the un-deviated rays that pass by the lens".

This statement retains attention because, at first sight, these rays around the lens seem totally useless and therefore irrelevant to this topic. However, they attest to a crucial fact: the lens interacts with only a part of the incoming flux, and transforms it geometrically. This diagram with "useless rays" points to the very nature of the process of imaging. Once this is understood, a part of the lens can still be seen as a lens, which intercepts a part of a part of the incoming energy. Ultimately, what is at stake is a first access to the status of an extensive quantity –energy- vis-à-vis this topic of imaging. *De facto*, the targeted content has changed.

3.2 Solid friction

Nearly as well-known as the preceding example, students' difficulties with solid friction are often interlaced with their common views about the third law. As a result, a diagram like the one in Figure 4a is often observed for a driver pushing his car toward a garage. When presented with a possible conceptual aid, i.e., fragmented diagrams (Figure 4b, Viennot 2003, 2004a), some students in the first year at university willingly acknowledged the consistency between this model and Newton's laws: "Yes, this forward force, we need it". But this first response from the teacher did not suffice, and a student said: "But the ground is motionless, it cannot push". When the teacher responded once more, this time by pushing on a nearby wall, she was contradicted again: "But the ground is horizontal, it cannot push". Then a model was proposed for the respective profiles of the ground and of the sole: saw-teeth. Figure 4c shows how evocative this model is, and a student's comment attests to its explicative power: "it's like pushing on little walls".

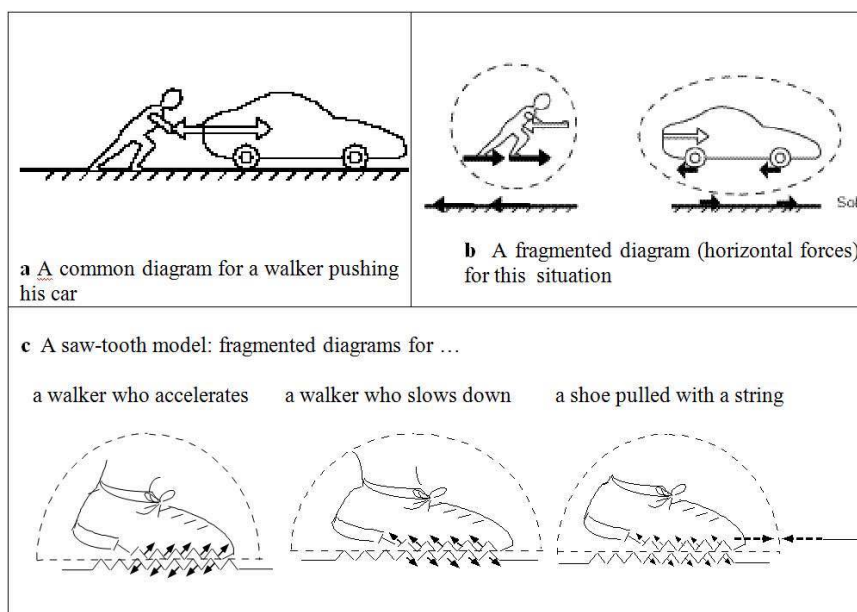

Figure 4. Walking and pushing: a common diagram (a) and two suggestions for teaching (b, c: Viennot 2003, Viennot 2004a, Besson & Viennot 2004)

The point of interest here is that, through successive responses to students' difficulties and objections, a new aspect of content was injected in the discussion: a first approach to a mesoscopic model, that is, to a scale of analysis now very much in use in physics research (Duran 1999, Krim 2002). A similar approach was used soon afterwards with the topic of fluid statics (Besson & Viennot 2004).

3.3 Some other cases

Table 1 displays some other examples of investigations that have, for a long time now, been taking students' views into account in this way. A responsive process has led their authors to rethink the subject matter, thus presenting their students with aspects of the content not commonly highlighted.

Table 1. A few examples of a new content spotlighting, in response to students' common ideas

Students' common perspective	Common comments	New spotlighting of the content
The « travelling image » syndrome	We can see an image without a lens, erect this time. A mask on the lens, then a hole in the image.	A new diagram with “useless” rays, the imaging process, role of energy (Viennot & Kaminski 2006)
Friction: “the ground cannot push”.	The ground is motionless, it is horizontal, it cannot push.	The mesoscopic approach: a saw-tooth model (Viennot 2003)
Pressure in fluids: a manifestation of weight	The fish in the sea feels greater pressure than in the cave (same depth)	The mesoscopic approach: The sponge balls model (Besson & Viennot 2004)
Third law : <i>de facto</i> denied	The table cannot exert a force	The deformable table (Brown 1994, Clement <i>et al.</i> 1989)
Electric circuits : sequential reasoning	The second bulb (<i>in a series circuit</i>) lights less.	From electrostatics to quasi-stationary currents, via the study of propagative transients (Barbas & Psillos 1997, Chabay & Sherwood 2002)
Vision without light in the eye	I can see the ray.	Discuss: dazzling, more or less light (de Hosson & Kaminski 2007)
Archimedes' principle not seen as an interaction	It has nothing to do with pressure	Discuss: making holes in water (Ogborn 2012)

Of particular interest is the rationale stated by Chabay and Sherwood (2006), concerning their project in electricity and magnetism (Chabay and Sherwood 2002): it takes the common trend toward linear causal reasoning into account. The idea (see also Psillos 1995, Barbas & Psillos 1997) was to do justice to this common approach by explicitly dealing with transients in the realm of electric circuits, thus avoiding abruptly confronting the students with quasi stationary regimes. As compared to the changes previously mentioned, this one is much more radical. Indeed, the teaching of electro-magnetic phenomena was usually divided into electrostatics, magneto-statics, electric circuits in quasi-stationary regimes (including variable currents), and waves. It was really a novel choice to focus on the propagative transitory phase ($\approx 10^{-8}$ s) between a static situation – a battery and its ends – and what occurs between the time a circuit is closed and the quasi-stationary regime is established. This choice makes it possible to reconcile the students' tendency to adopt a linear causal reasoning and the counter intuitive systemic view of a circuit.

The following quote (Chabay & Sherwood 2006) expresses the authors' perspective very clearly:

Some research and development in physics education has focused on remedying particular problems with the traditional sequence by giving students additional focused practice on selected concepts. However, without addressing the overarching issues of structure and coherence, it is difficult to do more than improve student performance on isolated tasks. We have chosen instead to reexamine the intellectual structure of the E&M curriculum to identify which concepts are centrally important, how these concepts are

related, and how they can be introduced to students at the introductory level in a coherent, comprehensible sequence.

4. Responding to students' ideas: a new spotlighting of the content (model 1b)

The preceding examples lead to, or echo, a notion previously suggested to characterize what it means to think about the content for teaching: the *spotlighting* of a content (Viennot 2003, 2004b). In these examples, what has been changed in the research process is a way of seeing the content: angle of vision, field, zoom, contrast. It is not mere simplification. If an “elementarising” process is at stake, this relies by no means on a straightforward mapping of the content. What is transformed is not a series of items, it’s a particular view of the content. In terms of selection, it is also that of a global aspect, not only a matter of local changes.

The label “spotlighting” was chosen to suggest that no new content, *stricto sensu*, is invented. As with a photographer with a given landscape, the reflexive decision on what to stress in the taught content leads the planners to emphasize, unify, differentiate, contrast, various elements according to particular goals. The invention is there, only there.

Figure 5 suggests in a metaphoric way what makes the construction of a new spotlighting really different from a series of fragmentary responses (i.e. model 1a): A more global reorganization of the content is aimed at.

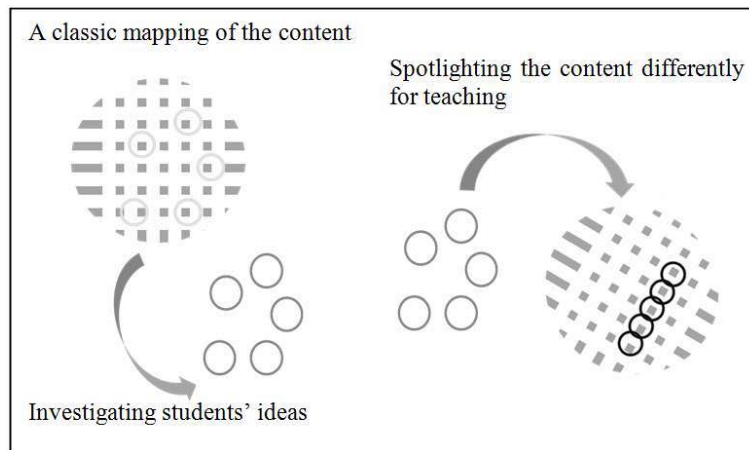

Figure 5. Taking into account students' ideas by spotlighting the content differently for teaching. Black circles symbolize changes informed by the knowledge of students' ideas (grey circles). Strictly speaking, a three dimensional diagram would be needed to account graphically for the “alignment” of previously unrelated items.

Figure 6 sums up how the dialogue between content analysis and the investigation of students' ideas may crucially involve an effort to stress the consistency of physics and highlight its crucially important concepts

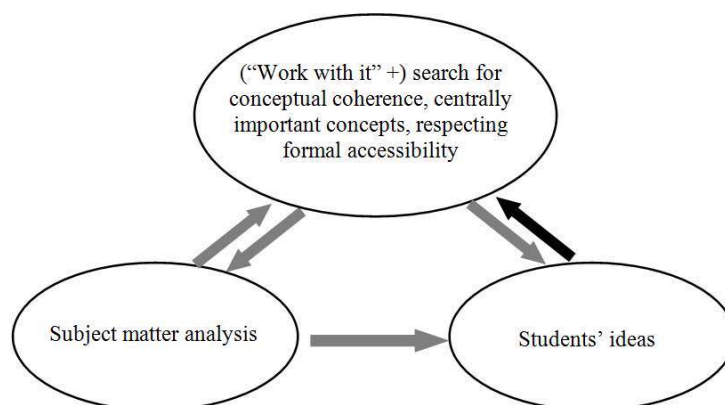

Figure 6. Taking into account students' ideas, possibly in the “work with it” modality (Duschl *et al.* 2011), by differently spotlighting the content for teaching: a process rooted in the search for conceptual coherence (model 1b). Black arrow: the decisive aspect that triggered a restructuring process.

It may happen that the new structuring at least partly “legitimizes” some common ways of thinking, producing a “work with it” style described, for instance, by Duschl *et al.* (2011, see also Clement *et al.*

1989). This is typically the case with the idea of analyzing propagative transients in electric circuits, or in the teaching sequence about friction cited above.

4. Teaching rituals and responsive spotlighting of the content (model 2)

These two ways of revisiting a content analysis in the light of students' common ideas (models 1a and 1b) do not cover what was done in this respect in previous research. Some revisitings of content were triggered by the pinpointing of teaching rituals (Viennot 2006). Two examples follow.

4.1 From global to local: the hot air balloon

Particularly informative is the common statement in exercises about a hot air balloon. The target is to find the condition in which the internal temperature enables the balloon to stay in the air. The following hypothesis is quasi-universally enunciated: "(...) the pressure in the balloon is the same as the pressure outside the balloon" (Giancoli 2005), which means an isobaric situation. The explicit or implicit reason for this decision is that the hot air balloon is open at its lower aperture. This hypothesis permits an easy calculation of the required condition, via Archimedes' theorem and a perfect gas relationship. But, although the exercise can be solved easily thanks to this apparently reasonable hypothesis, the situation modeled in this way would be catastrophic for the balloon: a crash is to be predicted. One argument to support this prediction is that, with the same pressure on both sides of the envelope at every point, no resulting force would ensure the balloon's sustentation. One may also observe that an isotropic field of pressure is not compatible with a thrust in any privileged direction, i.e., upwards, here.

A responsive presentation of the related content, summed up in Figure 7, consists in emphasizing the core of fluid statics theory: it's all a matter of gradients. No pressure gradient means no upthrust. The fact that the balloon stays in the air is intrinsically linked to the change in pressure with altitude. From the aperture to the top of the balloon, internal pressure diminishes more slowly than external pressure, due to different densities of the air inside and outside the envelope. This argument, which admits that the two pressures are equal at the bottom of the balloon, accounts for the fact that the envelope is inflated and stays in the air.

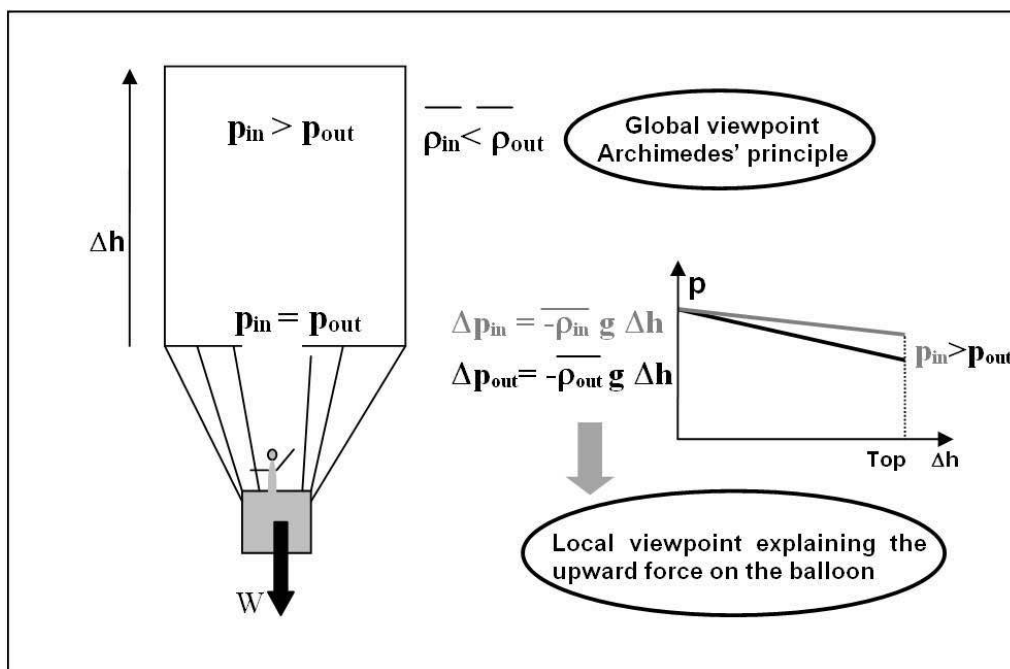

Figure 7. Some elements needed to understand how a hot air balloon stays in the air. W : weight of the system (basket+load+balloon). The unlikely cylindrical shape is intended to facilitate the understanding of how a resulting upward force is linked to a difference between internal and external pressure (Viennot 2006)

To sum up this responsive process, the spotlighting of the content changed from a global approach – linked to Archimedes' theorem - to a local analysis of the mechanical forces exerted on the envelope. In this case, it may be reasonably hypothesized that the observed global approach, leading to a correct answer, is to be attributed more to the teachers' choice than to the students' pre-scientific views.

4.2 From the local to the systemic: examples in fluid statics

Some teaching rituals may favor a local analysis and lead to suggestions for content spotlighting centered on systemic approaches. Thus, again in fluid statics, several situations have commonly given rise to local interpretations, like those suggesting that the column of water in an inverted glass (Figure 8a) exerted its weight on the cardboard, itself subject to a force due to atmospheric pressure (Viennot *et al.* 2009, Viennot 2010). Marie Curie (Chavannes 1907/2003) gave a similar comment for the column of water in a test tube inverted over a tank of water (Figure 8b). In all similar cases, the explanation is inconsistent with Newton's second law, and it seems appropriate to counterbalance such trends by spotlighting the systemic status of the situation: then the two "ends" of the system, broadly speaking, for instance the top and the bottom of a column of water, will fruitfully be taken into account. Acting on the upper recipient of a love-meter with cold water shows that both "ends" of the system matter. More generally, other examples illustrating that differences make the world go round (Boohan & Ogborn 1997) refer to the same concern (Viennot 2014).

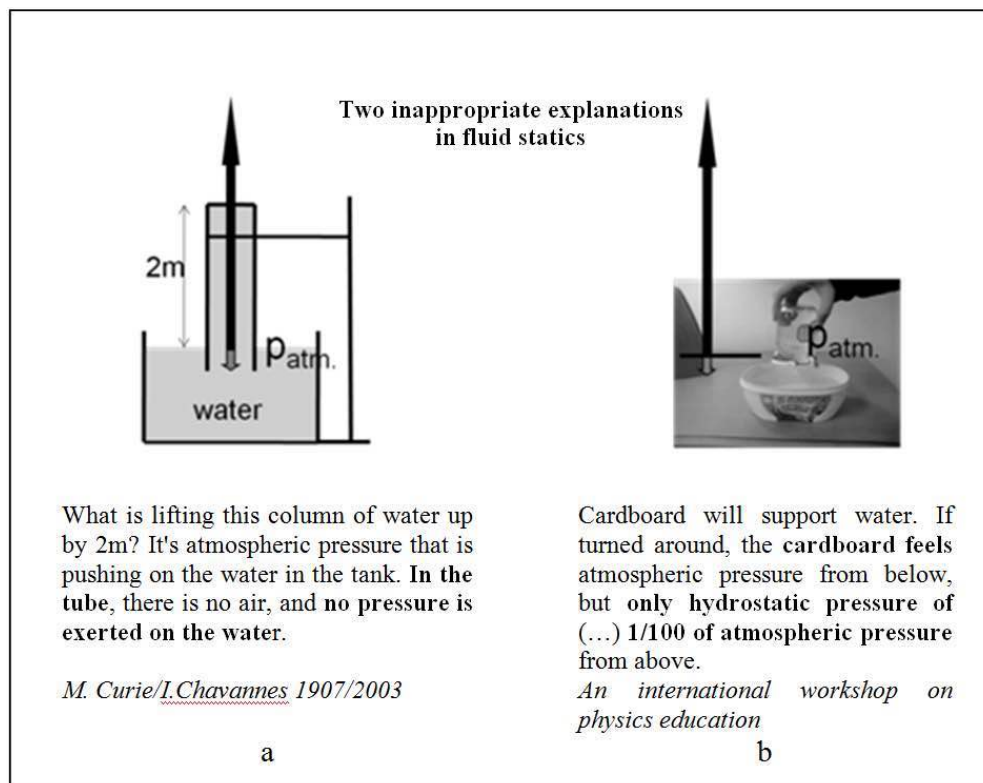

Figure 8. Two analogous examples of ritual and inappropriate analyses for physical systems: sentences in black are erroneous: They are compatible with the idea that an object always exerts its weight on its support. The diagrams are drawn by the author of this paper to point out that the forces mentioned in the quotes are unbalanced.

It is worth noting that, concerning the inverted glass, the responsive process may be said to start with the analysis of rituals, but at the same time these rituals are in resonance with some of the students' trends of reasoning, namely a local reasoning and thinking that an object always exerts its weight on its support. The label "echo-explanation" has been proposed to designate such cases (Viennot 2010).

In this case as with the previous one (the hot-air balloon), it is particularly manifest that the responsive process centers, on the part of the researcher formulating this proposal, on the desire to highlight conceptual coherence, links and key ideas in physics - here the need to consider *both ends* of the systems (Viennot 2010, 2014).

A specific model is proposed (model 2, Figure 9) for this process of content spotlighting prompted by a teaching ritual, whether or not it is also seen as a possible response to students' common ideas.

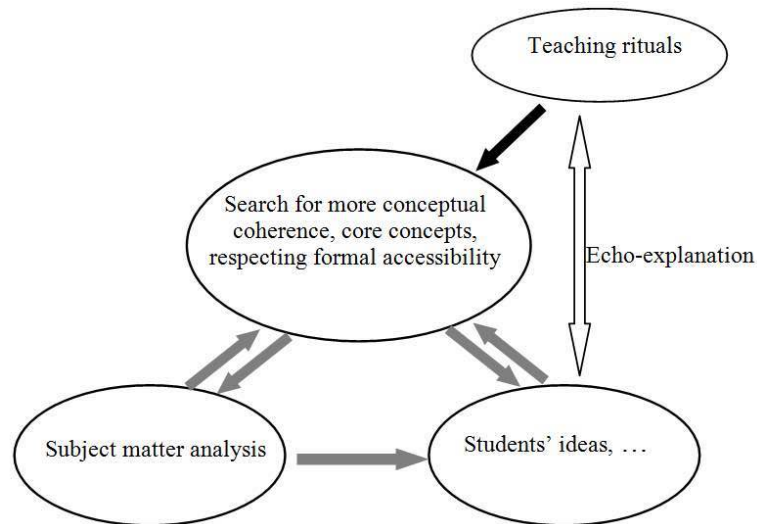

Figure 9. A model for a process of content spotlighting which is triggered by the analysis of a teaching ritual (model 2). Black arrow: the decisive aspect that triggered a restructuring process.

In fact, this desire has long inspired many teaching projects.

5. Proactive emphasis on conceptual coherence, links, strong ideas in physics (model 3)

It is not within the scope of this paper to recapitulate and analyze the multiple attempts made in the recent past to re-think physics for teaching, in the perspective of highlighting conceptual coherence and key ideas in physics, while respecting a constraint of accessibility. But it is worth noting that some famous instances of this effort preceded the start of what we now call Physics Education Research: *The Feynman Lectures on Physics* (Feynman *et al.* 1964-1966), the *Physical Science Study Committee* project (1960), the *Harvard Physics Project* (Holton 1969), the *Nuffield projects* (Fuller & Malvern 2010), for instance, were clearly inspired by this objective. Contemporary with the first research investigations in PER, the innovative reflections on the theme of *Change and chance* (Black & Ogborn, 1970-1979), or on energy (Boohan & Ogborn 1997) for instance, were of the same type. These high quality projects may be seen as typical of a proactive attitude (see also Michelini *et al.* 2000), which was not rooted in a precise knowledge of what students commonly think, even if some general considerations about the targeted audience were mentioned in their rationale. The reasons for their relative failure (French 1986) might include this lack of precise knowledge about students' difficulties, to say nothing of the teachers'. We simply mention these projects here in order to characterize a case (model 3, Figure 10) among attempts at re-thinking the content. This perspective is still present, to a greater or lesser extent, in more complex landscapes - the above "models"- of subject matter reconstructions.

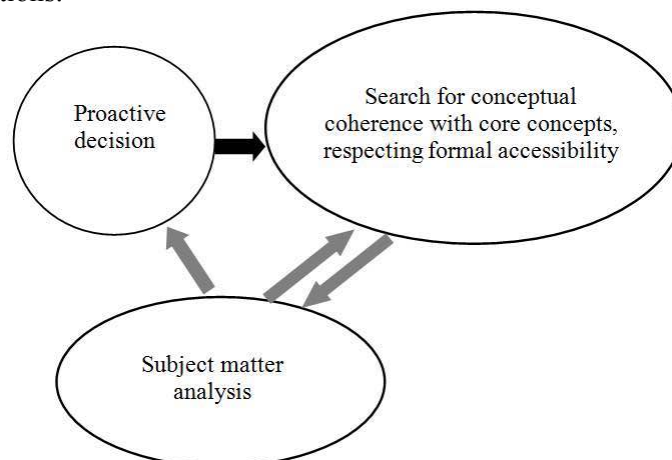

Figure 10. Proactive reconstruction of the content, not explicitly inspired by a detailed analysis of students' ideas and difficulties (model 3). Black arrow: the decisive aspect that triggered a restructuring process.

6. A “multi-source” spotlighting of content : two CDIPs

After this attempt at characterizing different starting points, reasons and ways to reconsider the content to be taught, it's time we remarked that nothing prevents us from blending these types of processes for a new spotlighting of a given topic. The following example is rooted in the combined consideration of some rituals and students' common ideas, as well as of conceptual coherence, links and strong ideas. The next section is devoted to a brief description of this twofold investigation with a focus on the underlying content analysis. In this particular example, the conceptual structure that was privileged is inserted in the frame of a particular teaching format: concept-driven interactive pathways (CDIP), keeping in mind that the “multi-source” character of a renewed content analysis could be observed with other teaching formats as well.

7 A teaching format: Concept-driven interactive pathways

The expression “Concept-driven interactive pathway” (CDIP) designates a type of teaching sequence with the following characteristics (Viennot & de Hosson 2015):

- It is designed with the goal of facilitating students' access to the understanding of a given conceptual content.

- It is interactive, implying teacher-student or teacher-group interaction. It may comprise phases like: exploring and discussing students' ideas, asking for argued predictions or diagrams and discussing these with students, letting students construct and analyse experimental results, injecting new ideas in a transmissive style, having students' criticize documents, etc. This adjective, “interactive”, refers to this statement: “Teaching is acting on other minds who react in response” (Ogborn *et al.* 1996, 141).

- It organizes a pathway, that is, a step-by-step process designed to help students progress toward the desired target. Although the structure of the pathway is mainly concept-driven, the development of transversal abilities – such as the critical faculty - is also favoured.

With such a format, the particular spotlighting of the content is of crucial importance, as illustrated below.

7.1 *The absorption of light: spotlighted ideas*

Two CDIPs on the absorption of light, each intended for an interaction of about one hour, have been designed and implemented. Depending on the targeted audience and school constraints, the first one, centering on the absorption of light by pigments (Viennot & De Hosson, 2012a, b), may constitute a preparatory step for the second one, about filtering process (Viennot 2013, Viennot & De Hosson, 2015), or each may be implemented alone.

Globally these two pathways are intended to spotlight the following conceptual targets:

- The absorption of light by pigments or filters is not an all-or-nothing process.
- It is a multiplicative process, involving multiplication by numbers smaller than 1.
- It is selective, that is, it depends on the wavelength.

These investigations were conducted on the basis of interviews with prospective teachers at university, the first one (*CDIP1*) with 8 students in the third year, the second one (*CDIP2*) with 6 students in the fourth year.

Our investigation with the first pathway (*CDIP1*) revealed that the interviewees were destabilized when the common binary rules – a pigment absorbs, or does not, such and such a part of the spectrum of white light (see Appendix) – turned out to be inappropriate, as when the impact of a red laser beam on a green pigment is quite visible. Moreover, we observed that they had considerable difficulty in understanding what it means to use percentages to analyze the process of absorption. These results provided the arguments at the basis of the construction of the second pathway (*CDIP2*), which is briefly described hereafter.

7.2 *Light and filters (CDIP2)*

The results of the first experimentation inspired us to investigate possible ways to help students to understand the multiplicative status of absorption. We chose to use filters, and made the hypothesis that the dependence of absorption on thickness might be an anchoring aspect for the targeted comprehension. Indeed, to understand the role of the successive, equally thick, layers of a filter, one has to understand that if one layer multiplies the incident intensity of light by, say 0,95, the second will let $0,95 \times 0,95$ of this initial intensity pass.

During the first phase, the interviewees were reminded of the classical rules, and were given a corresponding table (see Appendix). Then they were asked which mathematical operation came to their mind in this respect. All responded “subtraction.”

Then, they were shown a slide with a slit crossed by filtering strips of increasing thicknesses, made of one, two, three, etc., layers of a light yellow plastic sheet (Figure 11).

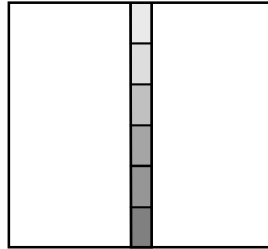

Figure 11. A diapositive with a vertical slit (width about 1mm), covered with one, two, three, ..., six horizontal strips made of transparent and thin plastic: light yellow, or light pink

They were then given a curve of transmission for one layer and asked to draw the curve for a strip with two or three superposed layers (Figure 12).

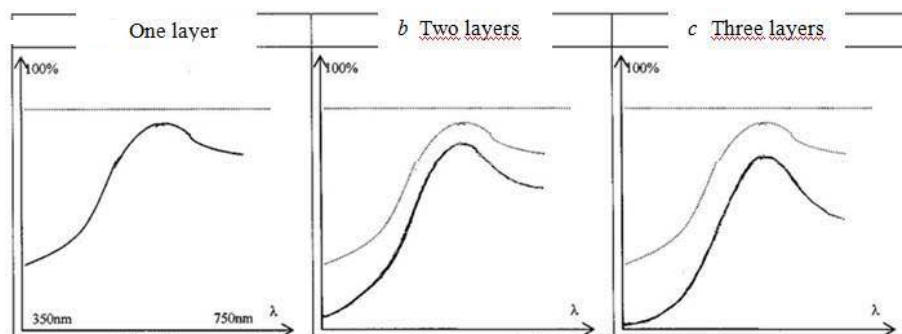

Figure 12. Given the transmission curve for one filtering layer, strips with two or three superimposed layers don't have a transmission curve of a similar shape

The drawings and the comments that were collected in this phase show how salient the idea of non-selective subtraction was, in other terms, the downward translation of the transmission curve proposed for one layer (Figure 13).

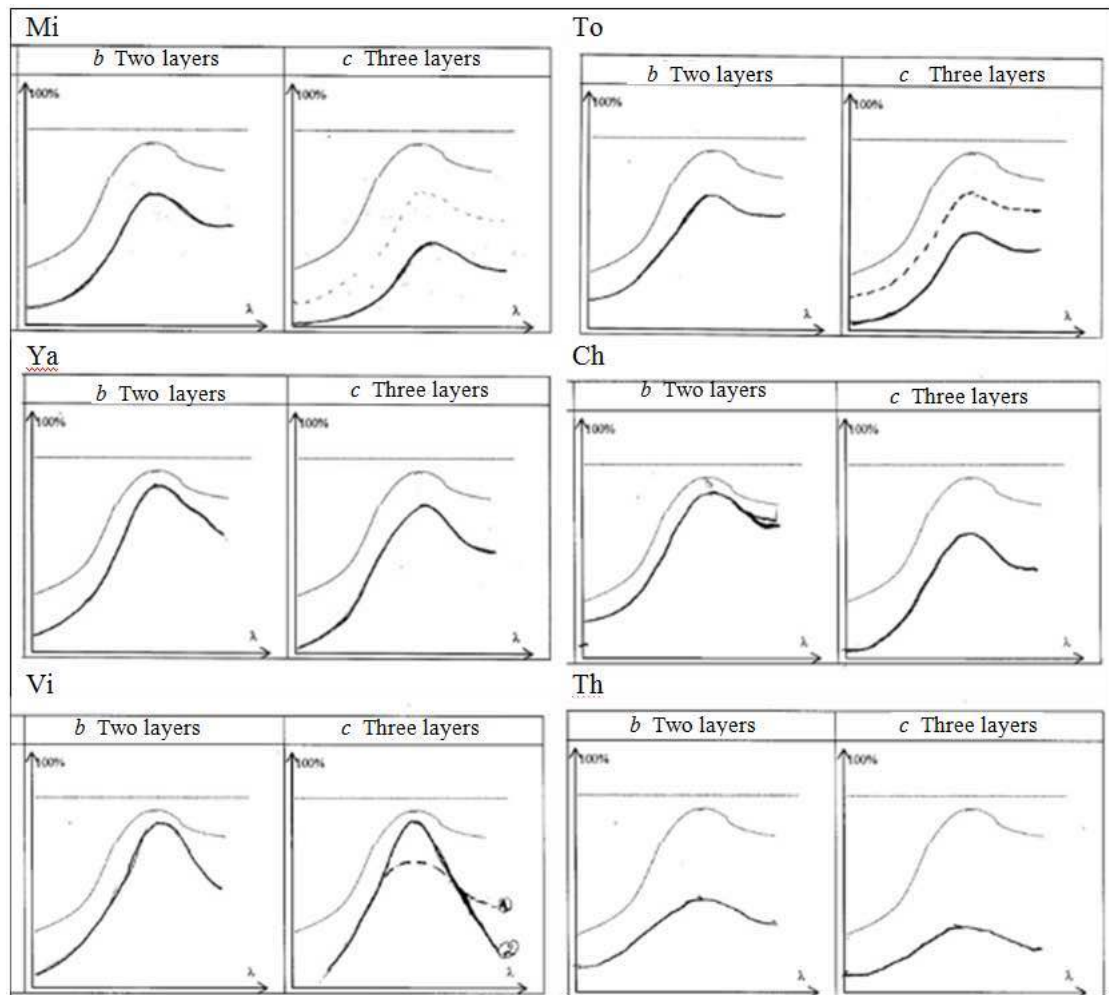

Figure 13. Transmission curves for two and three superimposed filtering layers drawn by students before the corresponding experiment

The following conceptual target was to use the idea of multiplication to realize and explain the deformation of the transmission curves with thickness.

Then an experiment proposed by the interviewer was performed to show the spectra of light transmitted by each strip of the slide shown in Figure 11. With this object, and also another one made of pink-magenta plastic, some parts of the spectrum (red and green) of the transmitted light seemed nearly unaffected by thickness whereas the blue part disappeared with the three-layer strip (photos of spectra are available in Viennot 2013). The discussion with the interviewer was more or less laborious, until all the interviewees manifested their comprehension of the conceptual target.

The subsequent phases were devoted to the transfer of this new knowledge to other situations, a liquid and a gaseous filter, respectively pumpkin seeds oil and the atmosphere. In these two cases, the change in colour of the transmitted light was explained by the interviewees, after discussion, on the basis of the initially provided transmission curve (Table 2, lines 5 and 6). Once the possibility of seeing oil or the atmosphere as filters was admitted, it became clear to the students that successive multiplications would come down to selecting the part of the spectrum where the rate of transmission was the highest, i.e. in both cases the “red” part.

Table 2 outlines the structure of this CDIP.

CDIP2: Main results concerning the students' ideas and reactions

In terms of comprehension, the prevalence and the resistance of the idea of – implicitly uniform - subtraction was very impressive:

Int (*Interviewer*): What did you use when constructing your answer, a line of reasoning founded on which type of operation?

Vi : Subtraction, mainly.

Or else,

To: We add subtractions.

The comments finally attesting to a real comprehension were all the more striking:

Mi : Given that it is proportional, ... (*adding filters*) we will end by selecting the spectral band of greatest transmission factor ...

Th: We've just seen that differences were majored when layers were added.

To: Even after having done this (*a multiplication*) right from the beginning, I wouldn't have interpreted this as a multiplication.

CDIP1 and 2: Main results concerning the students' metacognitive-affective comments

A final observation is worth pinpointing here. Beyond numerous expressions of satisfaction, we note the emergence of some meta-cognitive judgments:

Th: We've just seen that differences were majored when layers were added. I wouldn't have spontaneously used the word multiplication, I did not reason like that before coming here. (...) Perhaps, I would use the operation with the right data, but if I was asked for an explanation, I would never have used the word multiplication. CDIP2

We find here an echo of several comments collected during a subsequent workshop in a meeting of the European Science Education Research Association (Viennot & Mueller 2013), which was framed on this CDIP:

-The use of different thicknesses, we usually do it with only one and I had the idea of subtraction. CDIP2

- It made me think about things I knew about intuitively perhaps, but I still think it was as if I did not know about them previously. CDIP2

Table 2. Main steps in CDIP2

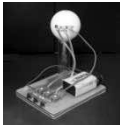
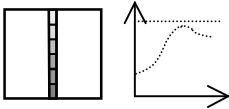
Phase	Our conceptual targets and questions	Material setting	Main aspects of the interaction (planned and/or expected)
<i>Rem</i>	Students are reminded of the classical rules First observation of their reactions Question: which operation comes to your mind: +, -, *, /?	 A colour mixer	The students appropriate the classical rules; predictions on this basis, observation, discussion, recapitulation. Table of rules left to students Question "which operation ...?"
<i>Filt-a</i>	-Draw the curves accounting for the transmission of light through two, then three layers of the same material: Do students just translate the first curve downwards, or do they/how do they change the shape of the curve?	 + Device to project spectra of the light transmitted through each strip Spectra observed	Predictions with arguments
<i>Filt-b</i>	Performing the experiment: Do they change their curves? Formulate a conclusion explicitly using selective multiplication?		Students asked to reconsider the curves, to account for the disappearance of "the blue" : strongly guided discussion

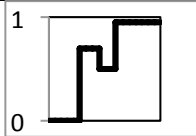
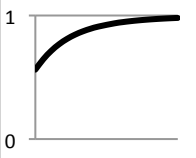
<i>Oil</i>	Observe colours of the oil, then apply a multiplicative procedure to the curve proposed by the interviewer to account for these colours		The interviewer -provides help for calculation. -explains how to use the sensitivity curves of the cones.
<i>Atm</i>	See the situation as a filtering case. Transform the curve provided by the interviewer for “one layer”		The interviewer provides help for -interpretation of the situation as a case of filtering - calculation
<i>Gene</i>	Ask about a function accounting for the changes of intensity observed		Input from the interviewer: (selective) exponential decrease
<i>Mca</i>	Global evaluation of the design		Interviewees express feelings

A critical stance also emerged among the interviewees at the end of both CDIPs, in this case concerning the binary rules used in the reminder phases:

- We have to be careful (with rules). CDIP1
- The (classical) rules (still) have a certain validity. CDIP1
- Given this, should we tell our students, we should use the law of additivity bla bla bla! Is it correct to use it? No, it's true, additivity is OK, it's for subtractivity (*that there is a problem*). CDIP2
- Showing the subtraction, if I may say, of colours, and coming back afterwards to something that comes down to percentages, it's rather, err, I don't know if you would've presented it like that. (...) For a student who is not used to it, it might be very disturbing. CDIP2

8. CDIP1 and 2: the reasons for a spotlighting

These two concept-driven interactive pathways have several common features in terms of spotlighting. They are designed on the basis of a very fundamental idea, sometimes referred to by the interviewees as a “tough idea”. The multiplicative nature of the process of absorption ultimately leads to the exponential dependence of intensity on the crossed thickness (CDIP2). Although this was hardly discussed in the short time we had, the process of absorption is multiplicative because it is statistical. For all of that, the formal complexity, which may seem very little, comes down to that of successive multiplications. It may also seem not to constitute the least “new idea”, despite the students’ recurrent comments. It is not “new physics”, but it is a spotlighting of physics that shows these pathways’ distance from the most prevalent teaching rituals, in this case the binary rules of the absorption of light by filters or pigments - still used without any discussion recently (Mota and Lopes dos Santos 2014). Students’ ideas are also taken into account, with the goal of extending the range of their line of reasoning when they pass from a view limited to subtraction to a more fruitful multiplicative approach. The decision was also taken to underline the links that physics enables us to establish: a multiplicative process accounts for changes in light which interacts with solids, liquids and gases. In terms of formal complexity, the price to pay is moderate. Simplicity is still favoured via the choice of equally thick layers and a discrete approach to exponential function. At the same time, simplification is kept under control as consistency is not seriously at risk. Figure 14 shows a sketch of this proactive and responsive, multi-source process of spotlighting a content for teaching.

9. Recapitulation and concluding remarks

In the light of the preceding analysis and of the various examples analyzed, some ideas seem to deserve consideration. With the first of the models proposed for the reasons for casting a new look at taught subject-matter, it is suggested that taking into account students’ ideas is not enough to ensure an actual revision of

the content. Rather, it appears that a stabilizing process may intervene, the “new” elements being in fact re-injected in the initial mapping of the content. This is not always the case, far from it, and examples have been given in which a new “spotlighting” of the content was designed in response to some features observed in students’ thinking. This said, ascribing a label of “newness” to such and such a suggestion is debatable, and the corresponding categorization cannot be clear cut. Rather, it defines some extreme cases of how conceptual goals are redefined for teaching.

A new spotlighting of a given content may also result from a response to some teaching rituals, with or without a concomitant awareness of students’ difficulties. These difficulties may or may not be in resonance with the rituals, as the label “echo explanation” suggests. In most (all?) cases of a really new look at the content, a thorough consideration of the coherence, links and key ideas of physics is likely to be at work.

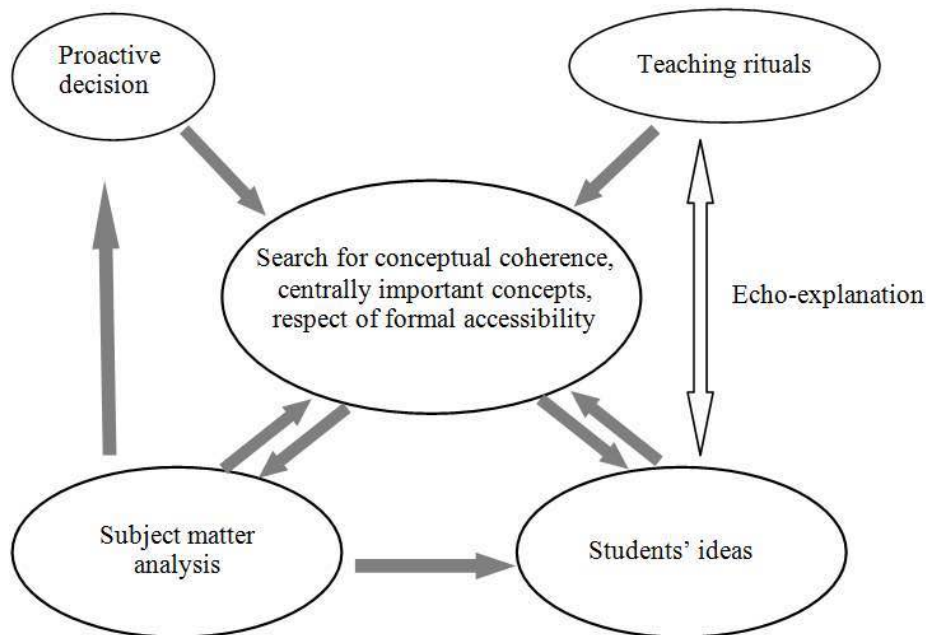

Figure 14. A multi-source process of content spotlighting, as in the case of CDIPs about absorption of light described here.

These reflections about new spotlighting distinguish between what it is to fruitfully re-think the content and the mere ideas of elementarisation and of simplification – if understood as unproblematic. In particular, simplification is not the master word in the previous examples. A smooth and horizontal ground may seem more simple than a saw-toothed profile which, however, proves more favorable to a sound comprehension of solid friction. To say nothing of the incoherent “simplicity” of an isobaric hot air balloon. In any case, simplification should be kept under control, and negotiated, keeping in mind the imperative of consistency. It is also worth noting that there is room for opening and enlarging a content analysis without ending up with excessive complexity. The last examples - namely the content driven interactive pathways about the absorption of light just described - illustrate, we think, the merits of a proactive/responsive, expert-led design of « new » spotlighting of content (i.e., led by a researcher and/or teacher): a design emphasizing consistency and conceptual links, as well as spurring an active engagement on the part of the students. Finally we might remark that the adjective “new” may seem deceptive, given that there is nothing new, strictly speaking, in the aspects of physics mentioned in this paper, apart from the decision to cast light on them (Viennot 1995). Here “new” does not mean reinvented physics, it means that attention is given to aspects of physics that have been commonly disregarded, or kept implicit.

One may wonder what possible obstacles may block this open reconsideration of content. Among good candidates, we suggest: a lack of distance with respect to rituals, an *exclusive* centering on students’ ideas with a « mirroring effect », *excessive* belief in (and focusing on) the power of new methods, the possible identification of « more rigorous » with « boring », and the common view that what is good for teachers cannot be good for their students. Clearly, more research is needed to give more substance to these assertions.

The preceding reflections also point to two strands of research of crucial importance, concerning fruitful ways to determine the content for research and practice.

One is the connection we can observe in students between an active search for consistency with conceptual links, on the one hand, and their intellectual satisfaction on the other. Without denying the motivation that can be raised via other entries, it would be highly contestable to deprive our students of teaching situations of the kind that make them conclude: “Thank you, you made me think”. But this connection between the affective and intellectual aspects is not straightforward, and deserves thorough attention and research.

Secondly, we have pointed out the limits of approaches to teaching that would rely on a separation between comprehending the content and developing certain competences. With the last examples reported here, it was particularly clear that conceptual development and a critical stance were not independent. A certain level of comprehension seems to be needed to trigger a critical attitude, even if the students’ initial knowledge was *a priori* sufficient to achieve this goal (see also Mathé & Viennot 2011, Viennot 2013, Viennot & Décamp 2013, Décamp & Viennot 2014). Further research is needed to support this claim. New insight in these research domains would be precious, in particular to inform rational decisions relating to the crucial question of how better to engage students in physics.

References

- Barbas, A. & Psillos, D. (1997). Causal reasoning as a base for advancing a systemic approach to simple electrical circuits. *Research in Science Education* 27(3), 445-459.
- Beaty, W. (1987). The origin of misconceptions in optics? *American Journal of Physics*, 55, 872-13.
- Bernardini, C. Tarsitani & M. Vicentini (Eds.) (1995). *Thinking Physics for Teaching*. New York: Plenum Press.
- Besson, U. & Viennot, L. (2004). Using models at mesoscopic scale in teaching physics: two experimental interventions on solid friction and fluid statics. *International Journal of Science Education*, 26 (9), 1083-1110.
- Black, P. J. & Ogborn, J. (1970-1979). *Physics Students' book and Teachers'guide Unit 9, Change and chance*, Nuffield Foundation Science Teaching Project, National STEM center. London: Penguin Books.
- Boohan, R. & Ogborn, J. (1997). Differences, energy and change : a simple approach through pictures, *New ways of teaching physics - Proceedings of the GIREP International Conference 1996 in Ljubljana*, S. Oblack, M. Hribar, K. Luchner, M. Munih, Board of Education Slovenia.
- Brown, E.D. (1994). Facilitating conceptual change using analogies and explanatory models. *International Journal of Science Education*, 16(2), 201-214.
- Chabay, R. & Sherwood, B. (2002). *Matter & interactions*. Volumes 1 and 2. New York: Wiley.
- Chabay, R. & Sherwood, B. (2006). Restructuring the introductory electricity and magnetism course. *American Journal of Physics*, 74(4), 329-336.
- Chavannes, I. (1907). *Leçons de Marie Curie aux enfants de ses amis (Marie Curie's lessons to her friends' children)*. Paris: EDP Sciences (2003).
- Clement, J., Brown, D., & Zietsman, A. (1989). Not all preconceptions are misconceptions: Finding ‘Anchoring Conceptions’ for grounding instruction on students’ Intuitions. *International Journal of Science Education*, 11(5), 554–565.
- Closset, J.L. (1983). D’où proviennent certaines erreurs rencontrées chez les élèves et les étudiants en électrocinétique ? Peut-on y remédier ? *Bulletin de l’Union des Physiciens*, 657, 81-102.
- Colin, P & Viennot, L.(2001). Using two models in optics: Students’ difficulties and suggestions for teaching. *Physics Education Research, American Journal of Physics Sup.*, 69 (7) S36-S44.
- de Hosson, C., & Kaminski, W. (2007). Historical controversy as an educational tool: Evaluating elements of a teaching–learning sequence conducted with the ‘Dialogue on the ways that vision operates’. *International Journal of Science Education*, 29(5), 617–642.
- Duit R, & Treagust D. (2003). Conceptual change: a powerful framework for improving science teaching and learning. *International Journal of Science Education*, 25(6), 671–688.
- Duit, R. & Von Rhöneck, C. (1998). Learning and Understanding Key Concepts in Electricity. In A. Tiberghien, E.-L. Jossem, and J. Barojas (Eds): *Connecting Research in Physics Education with Teacher Education* <http://icar.univ-lyon2.fr/Equipe2/coast/publication/livres.htm>

- Duran J. (1999). *Sables, poudres et grains*. Paris: Eyrolles Science.
- Duschl, R., Seungho, M. & Asli, S. (2011). Learning progressions and teaching sequences: a review and analysis. *Studies in Science Education*, 47(2)123-182.
- Fensham, P., Gunstone, R. & White, R. (Eds.) (1994). *The Content of Science*. London: The Falmer Press.
- Feynman R, Leighton R, & Sands M. (1963-1966). *The Feynman Lectures on Physics*. London-Reading: Addison-Wesley Publishing Company Inc.
- French, A.P. (1986). Setting new directions in Physics Teaching: PSSC 30 years later. *Physics Today*, 39 (9), 30-34.
- Fuller, K. D. & Malvern, D. D. (2010). *Challenge and change: a history of the Nuffield A-level Physics Project*. Reading : Institute of Education, University of Reading.
- Galili, Y. (1996). Students' Conceptual Change in Geometrical Optics. *International Journal of Science Education*, 18(7), 847-868.
- Giancoli, D.C. (2005). *Physics (6th ed): Instructor Resource Center CD-ROM*, Prentice Hall Gil-Perez, D. (2003).
- Gil-Perez, D. (2003). Constructivism in Science Education: the need for a clear line of demarcation. In: D. Psillos et al. (Eds.), *Science Education in the Knowledge Based Society (10-15)*. Proceedings of the third International Conference (ESERA), Dordrecht: Kluwer Academic Publishers.
- Goldberg, F. & McDermott, L. C. (1987). An investigation of student understanding of the real image formed by a converging lens or concave mirror. *American Journal of Physics*, 55 (2), 108-119.
- Härtel, H. (1985). The electric circuit as a system. In R. Duit and C. von Rhöneck (Eds.). *Aspects of understanding electricity* (pp. 343-352). Keil: Schmidt and Klauning,.
- Holton, G. (1969). *Harvard Project Physics: a report on its aims and current status*. *Physics Education*, 4(1), 19-25.
- Kattmann, U., Duit, R., GropengieBer, H. and Komorek, M. (1995). Educational reconstruction – bringing together issues of scientific clarification and students' conceptions. Paper presented at the annual meeting of the National Association of Research in Science Teaching, St Louis, MO, April.
- Kattmann U. & Duit R. (1998). The model of educational reconstruction. Bringing together issues of scientific clarification and students' conceptions. In Bayrhuber B. (Ed.): *What-Why-How? Research in Didaktik of biology*, 253-262.
- Komorek, M. & Duit, R. (2004). The teaching experiment as a powerful method to develop and evaluate teaching and learning sequences in the domain of non-linear systems. *International Journal of Science Education*, 26(5), 619-633.
- Krim J. (2002). Resources Letter: Friction at macroscopic and microscopic length scale. *American Journal of Physics*, 70, 890-897,
- Leach, J. & Scott, P. (2002). Designing and evaluating science teaching sequences: an approach drawing upon the concept of learning demand and a social constructivist perspective on learning. *Studies in Science Education*, 38, 115-142.
- Leach, J. & Scott, P. (2003). Learning science in the classroom: Drawing on individual and social perspectives. *Science and Education*, 12(1), 91-113.
- Lijnse, P. L. (1995). 'Developmental research' as a way to an empirically based 'didactical structure' of science. *Science Education*, 79(2), 189-199.
- Lijnse, P.L. (2002). Didactics of science: The forgotten dimension in science education research? In R. Millar, J. Leach & J. Osborne (Eds.), *Improving science education. The contribution of research*. Buckingham: Open University Press, 308-326.
- McDermott, L.C. (1996). *Physics by Inquiry, Vol. 1 and II*. New York: John Wiley & Sons.
- McDermott, L.C. (1998). Comment on Learning and Understanding Key Concepts of Electricity. In A. Tiberghien, E.-L. Jossem, and J. Barojas (Eds.): *Connecting Research in Physics Education with Teacher Education* <http://icar.univ-lyon2.fr/Equipe2/coast/publication/livres.htm>
- Méheut, M. & Chomat, A. (1990). The bounds of children atomism, an attempt to make children build up a particular model of matter. In P. Lijnse et al. (Eds.) *Relating Macroscopic Phenomena to Microscopic Particles*. Utrecht: Cdβ Press, 266-282.

- Méheut, M. & Psillos, D. (2004). Teaching-learning sequences: aims and tools for science education research. *International Journal of Science Education*, 26(5), 515-535.
- Michellini, M., Ragazzon, R., Lorenzo Santi, L. & Stefanel, A. (2000). Proposal for quantum physics in secondary school. *Physics Education*, 35(6), 406-410.
- Mota, A.R. & Lopes dos Santos, J. M. B. (2014). Addition table of colours: additive and subtractive mixtures described using a single reasoning model. *Physics Education* 49(1), 61-66.
- Ogborn, J. (2012). Archimedes' boat: making holes in water. *Physics Education*, 47(1), 134-136.
- Ogborn, J., Kress, G., Martins, I. & McGillicuddy, K. (1996). *Explaining Science in the Classroom*, Buckingham Open University Press: Buckingham.
- Pinto, R. (2005). Introducing curriculum innovations in science: Identifying teachers' transformations and the design of related teacher education. *Science Education*, [89\(1\)](#), 1-12.
- Psillos, D. (1995). Adapting Instruction to Students' Reasoning. In D. Psillos (Ed.). "European Research in Science Education", Proceedings of the second PhD Summerschool, Leptokaria. Thessaloniki : Art of Text, 57-71.
- PSSC (1960). *Physics*, 1st Edition. Lexington, MA : D. C. Heath and Company.
- Shaffer, P.S. & McDermott, L.C. (1992). Research as a Guide for Curriculum Development, An Example from Introductory Electricity, Part II Design of Instructional Strategies. *American Journal of Physics* 60(12), 1001-1013.
- Shipstone D.M. (1984). A study of children's understanding of electricity in simple DC circuits. *European Journal of Science Education*, 6(2), 185-198.
- Viennot, L. (1995). The Contents of Physics Essential Elements, Common Views. In C. Bernardini, C. Tarsitani & M. Vicentini (Eds), *Thinking Physics for Teaching* (pp. 67-76). New York: Plenum Press.
- Viennot, L. (2001). Reasoning in Physics, Chapter 5, Dordrecht : Kluwer/Springer.
- Viennot, L. (2003). *Teaching physics*. Dordrecht : Kluwer/Springer..
- Viennot, L. (2004a). The design of teaching sequences in physics. Can research inform practice? Lines of attention. Optics and solid friction. In E.F. Redish and M. Vicentini (Eds.): *Proceedings of the International School of Physics Enrico Fermi 2003, Research on Physics Education* (pp. 505-520). Amsterdam: IOS Press.
- Viennot, L. (2004b). Spotlighting a content for teaching: What physics education brings to teacher training. In M. Michellini (Ed.): *Quality Development in Teacher Education and Training, Second International GIREP Seminar Udine* (pp. 34-43). Udine: Forum, Editrice Universitaria Udinese.
- Viennot, L. (2006). Teaching rituals and students' intellectual satisfaction. *Physics Education*, 41, 400-408.
- Viennot, L. & Kaminski, W. (2006). Can we evaluate the impact of a critical detail ? The role of a type of diagram in understanding optical imaging, *International Journal of Science Education*, 28(15), 1867-1895.
- Viennot, L., Planinsic, G., Sassi, E. & Ucke, C. (2009). Various experiments involving fluids statics, Published by the MUSE group (More Understanding with Simple Experiments), EPS-PED. <http://www.eps.org/>, Education, MUSE.
- Viennot, L. (2010). Physics education research and inquiry-based teaching : a question of didactical consistency, In K. Kortland (Ed.): *Designing Theory-Based Teaching-Learning Sequences for Science Education* (pp. 37-54). Utrecht: Cdβ press.
- Viennot, L. & de Hosson, C. (2012a). Beyond a Dichotomic Approach, The Case of Colour Phenomena, *International Journal of Physics Education*, 34(9), 1315-1336.
- Viennot, L. & de Hosson, C. (2012b). Colour Phenomena and Partial Absorption, Published by the MUSE group (More Understanding with Simple Experiments), EPS-PED. <http://www.eps.org/>, Education, MUSE.
- Viennot, L. (2013). Colour phenomena and selective absorption: the role of thickness of absorbing medium, Published by the MUSE group (More Understanding with Simple Experiments), EPS-PED. <http://www.eps.org/>, Education, MUSE.
- Viennot, L. & Mueller, A. (2013). The selective absorption of light. *Physics Education*, 48(6), 700-701.
- Viennot, L. (2014). *Thinking in physics The pleasure of reasoning and understanding*. Dordrecht: Springer/Grenoble Sciences.



Viennot, L. & De Hosson, C. (2015). From a Subtractive to Multiplicative Approach, A Concept-driven Interactive Pathway on the Selective Absorption of Light. *International Journal of Science Education*, 37(1), 1-30.

Vollebregt, M.J. (1998). A problem-posing approach to teaching an initial particle model. Utrecht: CDβ Press.

White, R. & Gunstone, R. (1992). *Probing understanding*. London: The Falmer Press.

Appendix Colour phenomena: classical rules

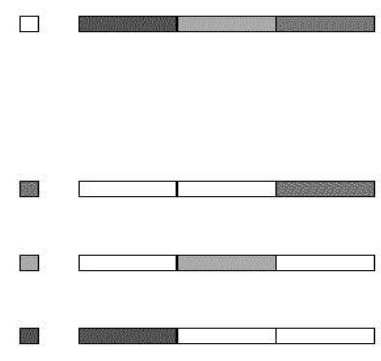
Here the colours are associated with “thirds of the spectrum”

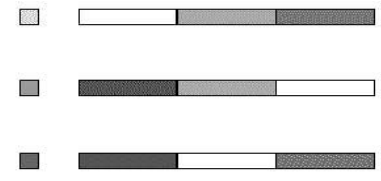
<p><i>Separating the various radiations that constitute “white” light gives a “spectrum”. The spectrum of white light ranges from $\lambda = 400 \text{ nm}$ to $\lambda = 700 \text{ nm}$. (λ: wavelength in empty space; $1 \text{ nm} = 10^{-9} \text{ m}$)</i></p>	
<p>Here the spectrum is divided diagrammatically into three equal parts.</p> <p><i>Coloured lights with a spectrum corresponding to a third of the preceding one are seen respectively as</i></p> <p>red in the long wavelengths</p> <p>green in the medium wavelengths</p> <p>blue in the short wavelengths</p>	
<p>Additive mixing: Combining these three lights in various proportions produces a wide range of colours and, when the proportions are right, white.</p> <p><i>Adding two of these lights in correct proportion gives respectively a light seen as</i></p>	
<ul style="list-style-type: none"> - yellow if you add red light and green light - cyan, if you add blue light and green light - magenta, if you add red light and blue light 	
<p>Absorbing role of filters or pigments</p> <p><i>A filter (or a pigment) absorbs a part of the spectrum of white light :</i></p>	
<ul style="list-style-type: none"> - a yellow filter absorbs blue light (a third) and diffusely reflects green and red lights. - a cyan filter absorbs red light (a third) and diffusely reflects blue and green lights. - a magenta filter absorbs green light (a third) and diffusely reflects blue and red lights. 	

Chapter 2
***Physics Teaching/Learning at Primary Level and
Teacher education***

Teaching About Energy Using Cooperative Learning: an Implementation and its Evaluation in a Teacher Training Degree

Arantza Rico¹

*Departamento de Didáctica de la Matemática y de las Ciencias Experimentales.
E.U. de Magisterio de Vitoria-Gasteiz. University of the Basque Country
UPV/EHU. Juan Ibañez de Sto. Domingo, 1, 01006, Vitoria-Gasteiz. Basque
Country (Spain).*

Abstract

This research was performed within a 9 ECTS science course implemented in a Degree of Primary Education. The course was based on cooperative learning where, organised in groups of 3 to 5 people, the students had to design a lesson plan for the primary classroom, which could cover the concept of Energy from different angles. This task was presented as a “real-scenario” project. In this paper I present and discuss the starting point and learning outcomes of pre-service primary teachers regarding the understanding of Energy as a scientific concept, which was measured before and after a series of lectures and lab sessions devoted to study the concept of Energy and how it is learned in Primary School (10-12 years). The assessment tools were varied and included open-ended and multiple-choice questions. From a colloquial understanding of energy, primarily as an energy source, pre-service primary teachers learned about energy forms and its transformations, dissipation and the conservation of energy. As expected, some difficulties arose differentiating forces and energy or grasping the abstract but at the same time quantitative nature of Energy. The applied methodology received overwhelming support from the participants and received positive feedback and approval from an institutional program to promote active learning methodologies at the university level. A further cycle of implementation/evaluation of the proposal is under way.

Keywords

Energy, Nature of Science, cooperative learning, project-based learning, pre-service teachers, primary education, , energy conservation.

1. Introduction

Cooperative Learning at Higher Education Institutions.

The European Higher Education Area (EHEA) has elicited a change of paradigm in this institution, calling for the education of flexible professionals that work in a knowledge society. In the Bergen Conference of 2005, a qualifications framework was established whose main goal was to educate future professionals that “can apply their knowledge and understanding in a manner that indicates a professional approach to their work or vocation, and have competences typically demonstrated through devising and sustaining arguments and solving problems within their field of study” (Bergen Communiqué, 2005). The use of active methodologies, such as cooperative learning (CL) and Project-based learning (PrBL) (Johnson et al., 1991) has proved to be an efficient tool to drive this change of paradigm. Cooperative learning is the instructional use of small groups so that students work together to maximize their own and each other’s learning, and proves an essential tool when students design and develop a project in groups (Johnson et al., 1991). Thus, I agree with Donnely and Fitzmaurice (2005) to understand PrBL as a group activity that goes on over a period of time, resulting in a product, in this case a science lesson for the primary classroom, which typically has a time line and milestones, and other aspects of formative evaluation as the project proceeds. This is the context in which an annual course of Natural Sciences for the Primary Classroom was designed, in which

1. The author would like to thank the UPV/EHU for organising the ERAGIN faculty development program in Project Based Learning methodologies for university educators, in which this implementation was designed, evaluated and approved for publication as teaching material.

students used PrBL to learn about core concepts of science and produce a lesson plan for the primary classroom. One of the core concepts that was included in this annual course was the concept of Energy, which would be approached by some of the students when designing their lesson plan.

2. Learning and teaching about energy

Scientific concepts are acquired and developed through different stages of compulsory education (National Research Council, 2007). Energy is one of the core concepts in science, and it is essential to understand physical, biological, chemical and technological aspects of our world (Driver and Millar, 1986). In recent years, its relevance has increased in light of important social issues including climate change and energy production, use and conservation (Bueno, 2014; Mohan et al., 2009). Despite that energy and their related phenomena, such as light, sound, heat or electricity, are taught throughout the whole curriculum, including kindergarten (Hook and Huziak-Clark, 2008), teaching and learning about energy is not trivial in any educational stage (Tobin et al., 2012). In fact, students' alternative ideas about energy and ways of using the term are very different from scientists' (Watts, 1983). Energy itself is an inherently abstract concept and quantitative at the same time (Heron et al., 2008; Tobin et al., 2012). In common language it is often not clearly distinguished from force, momentum, movement and power (Kruger et al., 1992; Solomon, 1985; Watts and Gilbert, 1983). In this sense Feynman's (Feynman et al., 1963) famous definition of energy as a conserved quantity is beyond grasp of elementary students or even pre-service primary teachers (Heron et al., 2008). Nevertheless, unlike children, pre-service teachers recognise a lack of rigour in their understanding of energy (Spiridou and Koumaras, 1993). Moreover, in primary school, teachers will still have to confront both their ideas about phenomena and their conceptions about the teaching process, which can be a complicated process since their ability to design innovative approaches seems to depend strongly on their scientific knowledge (Spiridou and Koumaras, 1993). As in other European countries, pre-service teachers are generalist teachers with a very limited amount of science education through an standard 4 year degree (15-20 ECTS at the UPV/EHU). Therefore, the teaching model presented here, takes into account constructivist approaches (CLIS, 1987; Heron et al., 2008; Tobin et al., 2012; Skamp and Preston, 2014), that future teachers could apply in their future professions, as well as addressing conceptual and persistent problems, such as defining Energy in scientific terms or understanding the principle of conservation of energy (PCE). To that effect, the learning proposal discussed here took into account the following key ideas about energy: i) Energy is a property of a system and there are different forms; ii) Energy can be transformed from one form into another; iii) Whenever energy is transformed some of it is degraded or dissipated; iv) The overall amount of energy in the system remains conserved; v) Energy can be approached in a qualitative way at early stages without betraying its quantitative nature.

3. Context of the Instruction and characteristics of the Project-based science course

The Energy Concept module was implemented in an annual compulsory course called "Science for the Primary Classroom" (9 ECTS) following a Project-based methodology. The research was performed on 118 students. A total of 8 sessions comprising 100 minutes each were carried out, and four of these were performed in the lab. These sessions consisted on: a) assessing students' conceptions of energy using open ended questions and multiple choice exercises (CLIS, 1987; Varela et al., 1993), b) examining energy in food and its transformation into heat energy, c) examining energy in non-living things, by analysing processes or devices involving kinetic and potential energy d) describing energy transformations and identifying energy dissipation, e) identifying and differentiating forms and sources of energy g) understanding the PCE and h) assessing student's learning using a post-implementation questionnaire.

4. Research questions

In this report I will discuss the Primary Education Degree students' initial ideas on energy and its development after instruction through a hands-on enquiry-based module on Energy. The research questions are summarised here:

1. What is the initial knowledge of the Energy concept in Primary Education students?
2. Will the proposed teaching sequence help students identify young pupil's most common conceptual problems about energy?
3. Will the proposed teaching sequence help students apply the PCE in ideal conditions?
4. What is the level of satisfaction about the methodology?

5. Methodology

Assessment of the Energy Concept

Participants were asked at the start to perform two exercises to evaluate their initial ideas. The first exercise consisted on answering the following question: “What do you understand as Energy?, Write sentences with the word Energy on them”. Pupils were organised in informal groups of 4 and wrote five sentences each. Afterwards, they discussed their sentences and whether they agreed or not with their statements. These sentences provide insight into the students' ideas and ways of thinking about energy. The terms and concepts used were counted and from these data categories were defined. Finally, frequencies for the defined categories were obtained.

The second question was extracted from the CLIS project (CLIS, 1987) and is called “Mickey's truck”. An image of a clockwork truck toy is shown, and students need to decide when it has more energy. The exercise aims to detect whether students exclusively relate energy with movement and correctly understand the principle of Energy conservation. This exercise was performed individually. Answers were classified in the categories proposed by the exercise: “A-The energy is at its highest before winding it up, B-the energy is at its highest just when it is wound up, C-The energy is at its highest when it is moving, D-The energy is highest when it stops, E-The energy is always the same”, and frequencies were calculated.

At the end of the Energy module, students were asked to answer two questions regarding primary pupils' ideas on energy and solve a problem of mechanical energy (ME) and application of the PCE. The two questions are shown here:

Q1. “Many students think that only moving objects have energy. What would you do to improve this idea?”

Q2. “Many students think that the higher an object is the bigger its force is. What would you do to improve this idea?”

Their answers provided insight on whether a conceptual and pedagogical understanding of energy had been achieved after the implementation. Regarding Q1, it was expected that the students would provide different examples of ME or everyday examples of energy transformations. Regarding Q2, it was expected to find definitions of force and energy or to establish differences between the weight and the Gravitational Potential Energy (GPE) of an object. Regarding the problem of application of the PCE, answers were classified following six formulation levels: L-1: A qualitative explanation of the problem along with a correct application of ME formula and the PCE was included; L-2: A qualitative explanation is included, formulae are used but the application of the PCE is wrong; L-3: A qualitative explanation is included but the application of the PCE is wrong or there are mathematical errors when applying the formula; L-4: There is not qualitative explanation nor mathematical reasoning; L-5: There is a correct mathematical reasoning of ME and PCE but not qualitative explanation.

Assessment about the methodology

The data presented in this report are part of a faculty program to implement PrBL at the University of the Basque Country UPV/EHU (Garmendia Mujika, Barragués Fuentes, Zuza Elozegi, & Guisasola Aranzabal, 2014). The students were asked to fill a survey about the methodology implemented during the science course that consisted of 17 questions to be answered on a four point Lickert scale and a yes/no question (data not shown). The questions analysed in this report correspond to Q1, 2, and 18 (Table 4).

6. Results

First Assessment of the Energy Concept (pre-implementation)

Table 1 shows the categories that emerged from the data from 164 sentences collected from 77 students. These students related energy mostly to sources (67 sentences) and particularly with renewable sources (40 sentences), followed by statements about saving or wasting energy (17 sentences; eg.: “saving energy is very important for our future”) and human functions (17 sentences). There were lesser instances where energy types (gravitational or elastic potential, kinetic, internal or light energy) and their transformations were mentioned (14 and 12 sentences, respectively). In contrast with other reports focused on detecting primary and secondary pupils' ideas on energy (CLIS, 1987; Watts, 1983) sentences related to sport activities, energy from food, etc., did not prevail (4 answers). Around a 4% of the answers showed confusing uses of the word Energy such as these shown here: “energy is a type of force”, “thanks to the force of the water in the reservoir, we get electrical energy“, “there are two types of energy, natural and chemical”. In most groups, a few sentences were also found to relate to the colloquial use of the term energy, but when discussed, all

students agreed that those uses were non-scientific (“He woke up with lots of energy”, “She is full of positive energy”) as previously discussed by Spirtou and Koumaras (1993).

Table 1. Categories emerged from 164 sentences including the word Energy

Categories	Number of answers (%)	Categories	Number of answers (%)	Categories	Number of answers (%)
Sources of Energy	10 (6.10)	Mechanical Energy	14 (8.54)	Heat	2 (1.22)
Renewable Energy source	40 (24.39)	Essential for life	9 (5.49)	Work	1 (0.61)
Non-renewable Energy source	17 (10.37)	Electricity	8 (4.88)	Thermodynamics	1 (0.61)
Saving/wasting energy	17 (10.37)	Confusions	7 (4.27)	Light	1 (0.61)
Human functions	17 (10.37)	Food energy	4 (2.44)	Force	1 (0.61)
Transformations	12 (7.32)	Photosynthesis	3 (1.83)		

Regarding “Micky's truck” question (CLIS, 1987), 63.2 % of the answers were correct (B category), around a 20% chose category C, which relates the maximum energy of the truck when it is moving, followed by a 13% answering E category, which stated that Energy was always the same. Categories A and D, which refer to the truck in an idle position (before and after being wound up) was answered by only a 5 and 1% of the respondents, respectively. When they were asked to justify their choice, their explanations fell into similar categories, which argued that the peak in energy would occur i) just when the truck was wound up (52.6%), ii) when the truck was moving (17%), or iii) that it did not change (16%) (showing a wrong application of the Principle of Conservation of Energy). It is also interesting to note that when arguing correctly that the peak of energy was just when the truck was wound (B category), the reason given in 40 % of the cases was that afterwards that energy would be “lost” (in movement). In fewer cases, the students argued that the accumulated energy would be transformed in movement (data not shown). Table 2 shows some examples illustrating this point.

Table 2. Examples of explanations to answers in categories B, C and E of Mickey's Truck exercise (CLIS, 1987).

B - Just when the truck is wound up

“Because to make the truck move, you need to wind the key. In that moment it has the most energy, once freed, you start losing energy”

“When you wind it up, you fill it with energy and then while it moves it goes losing energy slowly until it stops”

“All the energy is given to the truck and it has not spent any of it yet”

C - When it's moving

“When the truck is moving, it takes up speed, so it moves with more force. Therefore, it uses more energy.”

“Because in this moment, it is using the energy and in the other situations the energy is not used. Before it is a source of energy but it has not transformed into energy yet.”

“Because when it is moving, it is producing energy”

E - It's always the same

“The truck always has the same energy. When it is wound up, energy is transformed but it is always the same”

“The energy that the truck has at the start is the same at the end. Energy has been transformed but not increased or decreased”

The truck always has the same energy. Another thing is its speed.

Second assessment of the Energy Concept (post-implementation)

As stated previously, students performed a series of activities where they assessed different situations in which energy transformations were taking place. First, they assessed the energy stored in food and measured the heat released during combustion of different food sources. Afterwards, special emphasis was given to transformations of mechanical energy by working with springs, and balls falling freely and impacting on

trays full of sand. Half session was devoted to discuss Newton's Universal Gravitational Law to understand how Gravitational Potential Energy is stored in the object-Earth system (CLIS, 1987). Students also used computer simulations depicting a skater and a roller coaster² that enabled them to identify those transformations and to visualise the PCE. The simulations were also run in non-ideal conditions in order to understand energy dissipation in the form of heat. Finally, basic arithmetic operations and application of the PCE were carried out using Gravitational Potential Energy (GPE) and Translational Kinetic Energy (KE) formulae. In order to improve their pedagogical content knowledge, the students were given extracts of scientific articles on evidence-based teaching and learning about Energy (CLIS, 1987; Varela et al., 1993) which were discussed in the classroom.

At the end of the implementation, an individual questionnaire was passed to the participants that covered most of the topics and concepts dealt in the module (data not shown). In this section I will discuss the results of two open-ended questions that aimed to evaluate their understanding of primary students' alternative ideas about Energy and the results of a mathematical problem on Conservation of ME.

The first question (Q1, see Methods), asked students how, as teachers, they would help improving the idea that only moving objects have energy. It was expected that the students would use some of the examples seen during the Energy module. In this sense, nearly 80% of the students were able to give diverse examples of energy in the form of gravitational potential energy (17%), chemical energy as in stored in food (14%) or described transformation processes in where energy changes occur (45%). Interestingly, a very few examples of potential elastic energy (3.5%) were mentioned despite their previous lab session with springs.

Regarding Question 2 (Q2, see Methods), students were asked how, as teachers, they would help to overcome the idea that the higher an object is located, the bigger its force is. It was expected that the students would reflect on the experiments performed with falling balls and exercises on gravitation. As shown in Table 3, only a 39 % of the students were able to offer coherent explanations that differentiated between weight and gravitational potential energy, or gave correct definitions of both magnitudes.

Table 3. What is the difference between energy and force? Categories and frequencies emerged from the data

1-Gives both definitions	2-Discusses role of Weight in GPE	3-Compares both concepts	4-Incomplete/Incorrect
11 %	18 %	11 %	61 %

The students were also asked to solve a problem addressing the application of GPE and KE formulae and the correct application of the PCE in ideal conditions. Along with those operations the students needed to provide written explanations. In order to evaluate the students' achievement, the responses were assessed regarding 5 formulation levels (see Methods). Taking the three groups of students together (118), approximately half of the students (50% \pm 16.8) were able to give satisfactory written explanations as well as correct applications of the ME formulae and the PCE (L-1) but nearly 20% failed to give neither written explanations nor correct mathematical operations. Levels of formulation that corresponded to satisfactory written explanations but failing to apply the PCE correctly (L-2) or contained mathematical errors (L-3) were found in 14% and 12% of the cases, respectively. Interestingly, very few cases in which only the mathematical formulae were applied correctly but failed to give written explanations (L-5, 4%) were found. This could be possibly due to the fact that it was insisted upon the students that a written explanation would contribute to the final mark of that particular exercise.

Satisfaction survey about the methodology

Upon ending the module, a satisfaction survey consisting of 18 items inquiring about different aspects of the employed methodology was passed to the participants. Table 4 shows the results regarding three general questions about the methodology and we can stress that an overwhelming majority were satisfied with the experience compared to other traditional methods (85%) and that they would like to repeat this instruction method in further courses (91%).

2 PhET Interactive Simulations. University of Colorado. <http://phet.colorado.edu>

Table 4. Satisfaction survey about the instruction method

	Not satisfied	A little bit satisfied	Satisfied	Very Satisfied
1. Taking into account all the methodological aspects, How would you appraise this experience?	1 (1%)	8 (8%)	47 (46%)	43 (42%)
	Less	The same	More	Much more
2. To what extent do you think that this experience has helped you learning if you compare it with more traditional methods?	2 (2%)	5 (5%)	59 (58%)	28 (27%)
	YES		NO	
3. Would you choose this methodology in future courses?	91 (89%)		7 (7%)	

7. Discussion

Effective science training for pre-service primary teachers is a matter of concern within the science education community, partly due to the limited formal background in science and mathematics of future primary school teachers, although some authors argue that this could prove to be an advantage if they are open to learning and aware of what they don't know (Tobin et al., 2012). The reality is that degrees on Primary Education (at least in the Basque Country and Spain) produce generalist teachers and devote a relatively small fraction of their curriculum to science, which implies that in general the science that is taught is extremely broad. Moreover, the majority of the students enrolled in Primary Education degrees normally left science subjects at the beginning of secondary school (approximately a 3-5 year gap until taking on a university science course). Enquiry-based methods and a special focus on core concepts of science, such as Energy, is relevant in this context because not only it helps learners make sense of natural phenomena but also provides the opportunity to develop scientific skills, such as formulating hypothesis, contrasting results and debating ideas (National Research Council, 2007). Within an annual course that focused on active methodologies and project-based learning, a series of eight sessions were designed to teach pre-service teachers about Energy.

The main goal of this research was to evaluate the starting and final point on understanding the Energy concept in pre-service teachers. A possible constraint of this research could be that no identical questions were performed at the start and end of the Energy module. It is possible, though, to use non-identical questions provided that the same content is addressed. In this research the development of the students' ideas about energy was assessed qualitatively by comparing their initial sentences about energy with their answers regarding specific conceptual problems about energy at the end of the implementation. This approach showed that an important change of ideas took place among the participants. At first, their ideas emerging from the sentences were mainly related to renewable sources of energy and could not associate them with particular forms of energy, as known scientifically, which were practically unknown. In this sense, the course had an impact on how students could identify different forms of energy and the transformations among them. They developed an improved understanding of kinetic and potential energy and in some situations they identified dissipation in form of thermal energy, giving examples that had arisen during the course.

The analysis of Micky's truck exercise at the start of the Energy module showed that even in those cases where the correct category was chosen, an incomplete understanding of the PCE was observed in nearly half of the cases. When analysing the mathematical problem about the PCE, one can state that the conceptual understanding of the PCE in ideal conditions was developed in most of the students. This problem however showed other conceptual problems, because some students jumped into mathematical operations without any conceptual reasoning and, in some cases, (around 20%), serious but common mathematical errors, which have been widely reported in the literature (Kuo et al., 2013), were found. Therefore, these mathematical

representations proved to be obscure and somehow intimidating to a reasonable proportion of the students and should be used sparingly and accompanied or complemented with qualitative explanations.

Another prevalent conceptual error was the confusion or equivalent use of the terms force and energy (Watts, 1983), even after the instruction (Kurnaz and Arslan, 2011).

As Tobin and collaborators (Tobin et al., 2012) discussed after a workshop with in-service primary teachers, it can prove a difficult task to help the students to gain a view of Energy as understood by scientists, for whom Conservation of Energy is a fundamental and universal law, while providing a context for understanding energy as is used in socio-economic or domestic uses. The role of dissipation should receive more emphasis in future editions, since it has been shown that this process, and not the identification of tangible forms of energy and its transformations is more challenging (Duit, 1986), and if that is not properly understood, it conflicts with the everyday observation that the energy has been “used up” (Solomon, 1985).

Another aspect that was looked at in this work was how PrBL could help on mobilising the students' conceptual learning in situations related to their future profession, that is, developing professional knowledge (Bryan and Abell, 1999). The results of the survey and the students' final products (not shown) show that this approach helped motivating the students, which found a connection between theoretical concepts and practical work. Despite the general scientific knowledge gap that most pre-service teachers have, the challenge lies into motivating them to keep learning and find inspiration from science so they can also inspire their future pupils.

References

- Bergen Communiqué (2005). The European Higher Education Area-Achieving the Goals. *Communiqué of the Conference of European Ministers Responsible for Higher Education*.
- Bryan, L.A., and Abell, S.K. (1999). Development of professional knowledge in learning to teach elementary science. *J. Res. Sci. Teach.* **36**, 121–139.
- Bueno, A. de P. (2014). *La energía: Uso, consumo y ahorro energético en la vida cotidiana*, Graó, Barcelona.
- CLIS (1987). *Approaches to Teaching Energy*, Centre for Studies in Science and Mathematics Education, University of Leeds.
- Donnelly, R., & Fitzmaurice, M. (2005) Collaborative Project-based Learning and Problem-based Learning in Higher Education: A Consideration of Learner-focused Strategies. In G. O'Neill, S. Moore & B. McMullin (Eds.) *Emerging Issues in the Practice of University Learning and Teaching* (pp. 87-98). Dublin: AISHE/HEA.
- Duit, R. (1986). In search of an Energy Concept. In *Energy Matters*, Driver R. and Millar R. (Eds.), (pp. 67–101). Leeds: University of Leeds.
- Feynman, R.P., Leighton, R.B., and Sands, M. (1963). In *The Feynman Lectures on Physics*, Reading, MA: Addison-Wesley.
- Heron, P., Michelini, M., and Stefanel, A. (2008). Teaching and learning the concept of energy in primary school. In *Abstracts from the XIII GIREP International Conference*.
- Hook, S.J.V., and Huziak-Clark, T.L. (2008). Lift, squeeze, stretch, and twist: Research-based Inquiry Physics Experiences (RIPE) of energy for kindergartners. *J. Elem. Sci. Educ.* **20**, 1–16.
- Johnson, D.W., Johnson, R.T., and Smith, K.A. (1991). *Active Learning: Cooperation in the College Classroom*. Interaction Book Company, Edina, MN.
- Kruger, C., Palacio, D., and Summers, M. (1992). Surveys of english primary teachers' conceptions of force, energy, and materials. *Sci. Educ.* **76**, 339–351.
- Kuo, E., Hull, M.M., Gupta, A., and Elby, A. (2013). How students blend conceptual and formal mathematical reasoning in solving physics problems. *Sci. Educ.* **97**, 32–57.
- Kurnaz, M.A., and Arslan, A.S. (2011). A Thematic Review of Some Studies Investigating Students' Alternative Conceptions About Energy. *Eurasian J. Phys. Chem. Educ.* **3**, 51–74.
- Mohan, L., Chen, J., and Anderson, C.W. (2009). Developing a Multi-Year Learning Progression for Carbon Cycling in Socio-Ecological Systems. *J. Res. Sci. Teach.* **46**, 675–698.
- National Research Council (2007). *Taking Science to School: Learning and Teaching Science in Grades K-8*, The National Academies Press, Washington, DC.

- Skamp, K., & Preston, C. (2014). *Teaching Primary Science Constructively*. Cengage Learning Australia.
- Solomon, J. (1985). Teaching the conservation of energy. *Phys. Educ.* **20**, 165.
- Spiridou, A., & Koumaras, P. (1993). Educating primary teachers in science: the case of energy. In P. L. Lijnse (Ed.), *Proceedings of the first Ph.D. Summerschool* (pp. 259–265). Driebergen, The Netherlands: ESERA.
- Tobin, R.G., Crissman, S., Doubler, S., Gallagher, H., Goldstein, G., Lacy, S., Rogers, C.B., Schwartz, J., and Wagoner, P. (2012). Teaching Teachers About Energy: Lessons from an Inquiry-Based Workshop for K-8 Teachers. *J. Sci. Educ. Technol.* **21**, 631–639.
- Varela, M., Favieres, A., Manrique, M.J., and Pérez-Landazábal, M.C. (1993). *Iniciación a la física en el marco de la teoría constructivista*, Centro de Publicaciones del MEC, Madrid.
- Watts, D.M. (1983). Some alternative views of energy. *Phys. Educ.* **18**, 213.
- Watts, D.M., and Gilbert, J.K. (1983). Enigmas in school science: Students' conceptions for scientifically associated words. *Res. Sci. Technol. Educ.* **1**, 161–171.

Affiliation and address information

Arantza Rico
STEM Research Group. E.U. de Magisterio de Vitoria-Gasteiz
Departamento de Matemática y de las Ciencias Experimentales
University of the Basque Country UPV/EHU
Juan Ibañez de Sto. Domingo, 1
01006, Vitoria-Gasteiz
Spain
email: arantza.rico@ehu.es

Early Childhood Science Education in an Informal Learning Environment

Enrica Giordano, Sabrina Rossi

Physics Department of Milan – Bicocca University, Italy

Abstract

In this paper we present a learning/teaching experience about objects and materials performed with 5 years old children in Giocheria-Laboratori. This is an educational facility of Sesto San Giovanni, a municipality near Milan (Italy), designed for kindergarten and primary schools' informal science education. Since many years, we are collaborating with its educators to improve their science education proposal. In particular, in 2014 we collaborated to design and realize the "Unconventional matters" project, funded by the Italian Ministry of Education. The main aim of the project was to design and test some educational settings where many different types of scraps and unconventional materials are available to children of different ages (3-10 years old). The present learning/teaching experience was realized in the framework of that project, lasted one hour and a half and was focused on the young children's ways to approach objects and materials in a specifically designed setting. Here we illustrate and analyse the experience from a physics education perspective through a visual narrative of selected episodes.

Keywords

Early childhood, informal education, unconventional matters.

1. Introduction

In the last years, early childhood science education has been receiving increasing attention by the scientific community (Science, 2011). Researches in different fields, from neurosciences to learning and teaching sciences, have shown that children are far more competent in their scientific reasoning than suspected before and have substantial knowledge of the natural world since very early childhood (NRC, 2007).

In Italy we have a long tradition about high quality early childhood education, worldwide well known: Reggio Children experience and Montessori method and schools (Lillard & Else-Quest, 2006). Although activities and contents assume different meanings in these two approaches (Pramling Samuelsson, Asplund Carlsson, 2008), both are characterized by the care of emotional, artistic and social dimensions.

Recently, the Reggio Children group put in their proposals more emphasis on scientific aspects. The *Ray of light Atelier* in Malaguzzi International Centre is an example of its increasing interest in promoting educational contexts supporting "explorations that inspire wonder and curiosity and stimulate creativity and deeper inquiry" (Reggio Children, 2014).

They proposed the Remida cultural project "that represents a new, optimistic, and proactive way of approaching environmentalism and building change through giving value to reject materials, imperfect products, and otherwise worthless objects, to foster new opportunities for communication and creativity in a perspective of respect for objects, the environment, and human beings." (Remida, 2014).

In that perspective, they also created Remida centres to collect unconventional, alternative, waste, scrap materials with the aim to distribute them to schools and extra school educational contexts for specific educational projects.

In this paper, we present a learning/teaching experience about objects and materials performed in the informal environment of Giocheria-Laboratori. This is an educational facility of the municipality of Sesto San Giovanni (near Milan, Italy), offering informal science education to kindergarten and primary schools of the municipality since 1987.

Since many years, we are collaborating with the educators and the expert in childhood education of Giocheria-Laboratori. The collaboration aimed to improve their science education quality and to develop educational proposals linking the emotional, expressive, social and cognitive dimensions.

In 2014, we worked together to design and realize the “Unconventional matters” project, funded by the Italian Ministry of Education and aimed to design and test settings and laboratories about unconventional materials.

In particular, one of the main intents of the project was to transform the more spacious room of Giocheria-Laboratori, named the Pavilion, in a place where children could freely and safely explore many different types of materials and scraps recovered by Remida Centres and local industries.

Here, we illustrate and analyse a learning/teaching experience with 5 years old children from a physics education perspective, using a visual narrative of selected episodes from the entire experience.

2. Methodological details

The experience was performed in the “Unconventional matters” project’s framework, during an one hour and a half visit of a kindergarten school to Giocheria-Laboratori. In that context, the research question of our investigation was how children of 5 years old are able to distinguish between objects’ and materials’ properties.

3. Setting and investigation of children’s experience

The entire experience was made in the Pavilion, engaged 16 children of 5 years old, two educators of Giocheria-Laboratori and one of the author. The Pavilion’s setting was designed by the architect involved in the project with the aim to allow wide and deep explorations through many different types of unconventional materials and scraps.

Children were divided into two groups and were invited to make an investigation about materials present in the Pavilion. The two tasks were slightly different: the first group was invited to select some objects in a restricted area; the second one was invited to search for different objects made of the same material (plastic) all around the room. The groups worked separately for almost one hour, then they met each other to compare and discuss their findings.

According to the international early childhood education’s recommendations (NRC, 2001), the educators’ behaviour was intended to be responsive to children’s findings and questions. They had the role to be discrete guides trying to embrace what children caught during their explorations and support them in going further.

One of the author attended at the entire experience, following in particular one group. She had the role to be a participative observer. The approach she adopted was inspired by the observational “looking and listening-in” approach proposed by Sumsion and Goodfellow (2012). She used “openness, sensitivity, deep awareness, interpretation, and simultaneously, a suspension of judgement” in the way she tried “to gain insight into the meaning that infants make of their experiences” and to make her interventions (pag. 316-317)

Based on diverse theoretical perspectives (phenomenological, socio-cultural and social cognitive ones), the “looking and listening-in” approach was suggested “as a methodological approach for helping us to edge closer to understanding the infant’s experience, and as a way of describing how the infant made meaning of his experience”. In this context, we mainly used it in the first perspective.

4. Data collection and analysis

We generated data via observational and reflective notes and a video footage of the entire experience. The video gave us the opportunity to analyse children’s actions, gestures and discourses with more detail than using only a written observational record.

We watched the video repeatedly and independently each other, searching for episodes that might be particularly meaningful from the physics education perspective about the difference between object and material.

We then transcribed the selected episodes using InqScribe video analysis software (InqScribe© 2005 – 2009) and, finally, we constructed the visual narrative to illustrate and analyse the experience (Table 1). The visual narrative was constructed following the example of Sumsion and Goodfellow (2012) and the relative references.

The visual narrative and its reading

The visual narrative involves the first group of children, some objects of the Pavilion, the educator and the researcher. It illustrates an episodes’ sequence showing how the group investigates objects and materials with the support of experts in informal and physics education respectively.

Before the first episode represented in Table 1, children were sitting in a circle around the educator discussing with her about the objects they selected. After few minutes, a child introduced a jersey's ball and all began to discuss about it and the material was made of.

Table 1. Selected episodes' sequence of the learning/teaching experience



Photograph	Educator/Researcher	Children
	<p>“What have you chosen?(E)</p> <p>“How is it made?” (E)</p> <p>“Do you agree that is made of wool? Try to touch it” (E)</p> <p>“Someone says twine and not wool” (E)</p>	<p>“A ball”</p> <p>“Wool”,</p> <p>“Yes”</p> <p>“Twine”</p>
<p>Time 00:04:30.20</p> 	<p>“What happens if you push the ball?” (E)</p> <p>“Is the ball made of the same thing as these threads?” (E)</p>	<p>“If I push, it seems that it is hard”</p> <p>“I think there is a stone inside here. It is impossible to destroy!”</p> <p>“Yes”</p>
<p>Time 00:07:39.00</p> 	<p>“Why the threads are soft and the ball is hard?” (R)</p> <p>“It would be nice unrolling the ball and looking what there is inside” (E)</p> <p>“Maybe, it is better rolling the ball from the other end than unrolling it” (R)</p>	<p>“Because inside there is something on which you can roll up the twine”</p>
<p>Time 00:10:51.29</p>		

Table 1. (Continued)







Photograph	Educator/Researcher	Children
 <p data-bbox="304 667 496 689">Time 00:11:46.12</p>	<p data-bbox="676 342 1086 398">“Look at me. I don’t put anything inside, I just start to roll the thread” (E)</p> <p data-bbox="676 427 1070 450">“Can you try to touch the ball now?” (R)</p> <p data-bbox="676 479 1086 533">“Can you try to touch the one I’m rolling up?” (E)</p>	<p data-bbox="1114 454 1225 477">“It is hard”</p> <p data-bbox="1114 506 1225 528">“It is hard”</p> <p data-bbox="1114 562 1433 618">“It is decreasing more and more”</p> <p data-bbox="1114 618 1337 640">“There is only a knot!”</p>
 <p data-bbox="304 1003 496 1025">Time 00:15:05.21</p>	<p data-bbox="676 723 1018 745">“So, what makes the ball hard? (E)</p> <p data-bbox="676 801 1086 857">“I can make a very very big bunch of threads, is it hard? (E)</p> <p data-bbox="676 913 1086 969">“Do you think there is more thread in the ball or in the bunch?” (R)</p>	<p data-bbox="1114 741 1433 797">“Because it becomes very very big and it hardens”</p> <p data-bbox="1114 819 1257 842">“No, it is soft”</p> <p data-bbox="1114 958 1257 981">“In the bunch”</p>
 <p data-bbox="304 1361 496 1384">Time 00:17:04.14</p>	<p data-bbox="676 1099 954 1122">“How could we know that?”</p> <p data-bbox="676 1234 1086 1290">“Look, she attached two threads and she made a longer one” (R)</p> <p data-bbox="676 1290 954 1312">“So what could we do?” (R)</p>	<p data-bbox="1114 1126 1401 1149">“Because they are so many!”</p> <p data-bbox="1114 1178 1337 1200">“Wow, I made it long”</p> <p data-bbox="1114 1317 1401 1339">“We have to tie all of them”</p>

Table 1. (Continued)

Photograph	Educator/Researcher	Children
 <p data-bbox="300 622 491 651">Time 00:22:23.10</p>	<p data-bbox="667 277 1091 360">“So, can we make a very long thread using these pieces and then roll it to make a ball?” (E)</p> <p data-bbox="667 387 1091 465">“Do you think the thread made by small pieces will make a hard ball or a soft one?” (E)</p> <p data-bbox="667 470 1091 524">“If everyone ties two or three pieces, the thread will be long enough” (R)</p>	<p data-bbox="1114 331 1433 387">“Yes, we make knots and then we tie the threads”</p> <p data-bbox="1114 443 1305 465">“A ball very hard!”</p>
 <p data-bbox="300 992 491 1021">Time 00:34:43.23</p>	<p data-bbox="667 651 1091 730">“We had to find if the ball made by small soft pieces is hard or soft. Try to touch it” (E)</p> <p data-bbox="667 757 1091 842">“We still have to understand why many pieces tied together and rolled up make a hard ball. We have to think about it” (E)</p>	<p data-bbox="1114 734 1283 757">“It is very hard!”</p>
 <p data-bbox="300 1361 491 1391">Time 01:02:08.13</p>	<p data-bbox="667 1021 1091 1133">“They tried to tie the threads making knots, here she was able to tie two things in a different way. Do you show in which way to us?” (R)</p> <p data-bbox="667 1211 1091 1267">“Three ways to attack things without glue!” (E)</p>	<p data-bbox="1114 1137 1433 1245">The child shows how to attack two magnets. One child wedges a wire into a box and another wedges two cylinders.</p>
 <p data-bbox="300 1731 491 1760">Time 01:05:28.29</p>	<p data-bbox="667 1386 1091 1442">“Are there other ways to tie/attack things?” (R)</p>	<p data-bbox="1114 1413 1433 1632">Children go all around the Pavilion and try to tie things together using glue, magnets, press studs, Velcro and even water. They also explore the possibilities to build stable structures and move tying things.</p>

The pathway begins with a question “How is it (*the ball*) made?”. Children immediately say that it is made of wool, but touching the ball they change their minds (“it is made of twine”, photograph #1). Pushing the ball, children feel that it is hard. Touching some threads, they realize that are made of the ball’s material even though the threads are soft (photograph #2). The researcher asks the reason why this happen (“Why the threads are soft and the ball is hard?”, photograph #3) and some children suggest the idea of a stone inside the ball. This idea is explored unrolling the ball and simultaneously making another ball with the same thread. In this way, children verify that there is no stone inside the old ball and, at the same time, that the new one is still hard (photograph #4).

A child tries to explain the ball's hardens introducing the volume ("Because it becomes very very big and it hardens", photograph #5). The educator gets a lot of threads making a big bunch: it looks bigger than the ball but still soft. It is not a matter of volume.

The researcher then asks if there is more thread in the ball or in the bunch and how we could know that. A child realizes that two threads can be tie to make a thread longer than before ("Wow, I made it long", photograph #6).

Her finding suggests the idea to make a long thread joining together the small pieces (photograph #7). Rolling it, the educator makes another ball and children feel that it is still hard. No matter if the pieces are soft. Children realize that pieces and ball have different properties, even though they are not yet able to explain why this happen (photograph #8).

The learning/teaching pathway seems to be arrived at its end when the other group arrives to share findings. However, two children of that group show two other ways to take things together without glue (photograph #9).

Children go around in the Pavilion trying to tie things together with many different types of materials and exploring the possibilities to build stable structures and move binding things (photograph #10).

5. Conclusions

The research we presented in this paper explored the possibilities to introduce young children to first ideas about objects' properties as depending on material and/or on structure of the small pieces they are made of.

The opportunity offered by the Pavilion and by the large amount of objects available allowed children to explore objects' properties through senses (appearance, elasticity, softness, shine, texture, colour, etc.) and to look for similarities and differences among them. Moreover, its particular setting gave them the opportunity to investigate objects and materials following not stereotyped questions and finding their own answers.

The Pavilion' setting was an opportunity also for the adults involved in the experience. Scraps and cuttings without a conventional name or a recognizable function aided them to abstract from the idea of *object* to the *material* from which it is made and to make their interventions as much as possible from the children's perspective.

In the analysed experience, the educator let the children free to explore the environment using body and senses and to express emotion and creativity. She paid a lot of attention to children's questions and actions, trying to recognize hooks to the theme that children wanted to treat and dealing with the issue in a comprehensive way. She also supported the collaboration and the communication among children and the researcher.

As the visual narrative shown, the researcher was able to guide children to recognise that a jersey ball can be made of small pieces and that their properties can be different from the ball's one.

Althought it was not possible to introduce more advanced interpretations in the available time, children were introduced to the basic physics idea the object' properties depend on the properties of the single constituents, the kind of links among them and the arrangement of the entire structure.

6. Perspectives

Beside the experiences with kindergarten school, we are now working to introduce in the Pavilion workspaces with instruments and tools where primary school children can investigate objects and materials in interaction with water, light and heat sources.

Even though we are designing more structured experiences, it is our opinion that also primary school children need to recover the joy and the taste of exploring by senses before to be guided toward a more formalized knowledge.

For the next years, we hope to continue the collaboration with Giocheria-Laboratori and the schools of the municipality to design and test learning contexts and pedagogical progressions for formal and informal science education at different ages.

Acknowledgements

We thank the educators of Giocheria-Laboratori: Daniela Calò, Anna Cuccu, Laura Plebani, Simona Vimercati; Alessandro Porcheddu, the coordinator of Giocheria-Laboratori; Arch. Maurizio Fusina-Re Mida; all the children, teachers and parents participating to the labs and school experiences.

References

- AA.VV. (2011). Investing early in education, special issue, *Science* **333**, 909-1056.
- Lillard, A. and Else-Quest, N. (2006). Evaluating Montessori Education, *Science*, **313**, 1893-1894.
- NRC- National Research Council (2001). *Eager to Learn: Educating Our Preschoolers*. National Academies Press, Washington D.C., USA
- NRC-National Research Council (2007). *Taking Science to School: Learning and Teaching Science in Grades K-8*, National Academies Press, Washington D.C., USA.
- Pramling Samuelsson, I. and Asplund Carlsson, M. (2008). The Playing Learning Child: Towards a pedagogy of early childhood, *Scandinavian Journal of Educational Research*, **52**, 623-641.
- Reggio Children (2014) <http://www.reggiochildren.it/>
- Remida (2014) <http://www.reggiochildren.it/atelier/remida/>
- Sumsion, J. and Goodfellow, J. (2012). 'Looking and listening-in': a methodological approach to generating insight into infants' experiences of early childhood and care settings, *European Early Education Research Journal*, **20**(3), 313-327.

Affiliation and address information

Enrica Giordano
Sabrina Rossi
University of Milano-Bicocca
Department of Physics
Piazza della Scienza 3, ed U2
20126 Milano
Italy
e-mail enrica.giordano@unimib.it
sabrina.rossi@unimib.it

Using Videos and Video Editing Software with Pre-Service Teachers for our Modern Primary Science Classrooms.

Maeve Liston

Faculty of Education, Mary Immaculate College, Limerick and the National Centre for Excellence in Mathematics and Science Teaching and Learning, University of Limerick, Ireland

Abstract

International priorities and policies for improving teacher quality and teacher education place an emphasis on improving teacher competencies in the use of ICT and linking knowledge and information about ICT to curriculum delivery. Therefore colleges of Initial Teacher Education (ITE) need to ensure that all newly qualified teachers enter the teaching profession with the ICT knowledge and skills to be able to teach effectively, incorporating ICT into their teaching and learning strategies.

The aims of this research were to investigate the technologies being used by pre-service primary teachers during their teaching practice experiences in their first year of their undergraduate programme and to use an integrated approach to Science Education Modules where technology was used to further develop the students Subject Matter Knowledge (SMK), Pedagogical Content Knowledge (PCK) and their Technological Pedagogical Content Knowledge (TPACK) to prepare teachers to teach where technology significantly impacts and changes teaching and learning methodologies in primary science classrooms.

Questionnaires were distributed at the middle of the semester when the pre-service teachers had several experiences of teaching different subject areas, to investigate their use of technology in the classroom and again at the end of the semester to evaluate the integrated approach to the Science Education Modules (N=254). The results indicated that ICT was being used in a very limited manner during their school placement experiences. Digital videos were then designed and edited by the lecturer to deliver the science content using specific, effective and appropriate teaching and learning approaches to acquire understanding of a topic. Feedback from the pre-service teachers in the post-module questionnaire showed that the use of videos in lectures were successful in developing their knowledge and understanding in science. Their comments also indicated that the use of videos developed their PCK and TPACK, providing the pre-service teachers with ideas for future lessons, how to structure a lesson and how to use videos in the primary science classroom. Their end of the semester assignment involved the recording and editing of videos that the pre-service teachers could use in their teaching of science. Their experiences of and opinions on the assignment further highlighted that this module contributed in developing their SMK, PCK and TPACK.

The lecturer introduced the use of videos to the pre-service teachers and modelled this teaching methodology in her own teaching. This integration of the technology was time consuming and required a high level of commitment. The development of future teachers' TPACK in methods courses requires that teacher educators learn to integrate technology into their own practice. For teacher educators to integrate technology effectively into classes, they must receive appropriate training and support.

Keywords:

Teacher Education, Primary, ICT, SMK, PCK, TPACK

1. Introduction

The 21st Century has been characterised by the introduction of a wide range of modern technologies, with a vast selection of communication technologies to choose from and thus leading to the acceleration in the use of ICT in education (OECD 2001, 2005). In the past several decades there has been a considerable level of investment from governments with the aim of improving the amount of technology available, resulting in an increase in the access to and the use of ICT in primary schools across Europe (BECTA 2006; DfES 2005; EACEA 2007; DES 2001; NCTE 2004). However increasing access to computers in educational settings and

computer usage at home does not translate into the increasing use of technology in the classroom (European Schoolnet 2012; Eurydice 2004). It also does not translate into the productive use of and integration of technology into classroom activities (Cuban 2001; DiSessa 2001).

Integration of ICT requires training and support for teachers, innovation, and a change in teaching and learning strategies (BECTA 2006; Ofsted 2004). The 'Impact of Technology in Primary Schools (STEPS)' study found that National ICT Policies across Europe usually aimed at improving infrastructure and teachers' digital competence but were less frequently focused on the supply of digital learning resources and pedagogical reform (EACEA 2007). Studies have highlighted that there can be an over-emphasis on developing an awareness of the actual technology in many of the pre-service and in-service professional development courses for teachers rather than on models or frameworks for effective technological integration (Carr *et al.* 1998; Cox *et al.* 1999; Crompton and Mann 1996; Hargreaves and Fullan 1998; Mishra and Koehler 2006).

2. ICT and Science Education

Internationally, standards in Science Education place an emphasis on curricula where technology is an essential component of the learning environment, in both content and instruction (National Council of Teachers of Mathematics (NCTM 2000; National Research Council 1996; ISTE 2000). As far back as the 70's computer literacy was ranked as one of the ten key basic skills needed in mathematics and science education in the US (National Council of Supervisors of Mathematics, 1978). In the US the National Research Council states that a central component of scientific literacy is the appropriate use of technology to support learning goals (NRC 1996). However a gap exists between technology for doing science and technology for learning science (Songer 2007). Studies have shown that teachers often move away from the integration of ICT to focusing on teaching ICT skills in isolation to the curriculum subject areas (Tondeur, Braak and Valcke 2007). Tondeur, Braak and Valcke (2007) advocate that 'the educational use of ICT should be embedded within subject-orientated competencies'.

European priorities for improving teacher quality and teacher education, state there is a need to improve teacher competencies in the use of ICT, linking knowledge and information about ICT to curriculum delivery (BECTA 2006). Colleges of Initial Teacher Education (ITE) need to ensure that all newly qualified teachers enter the teaching profession with the ICT knowledge and skills to be able to teach effectively incorporating ICT into their teaching and learning strategies (NPADC 2001; Lim, Chai, and Churchill 2010; The Teaching Council 2011), placing an emphasis on the pedagogy of technology rather than focusing on the technical aspects of technology (EACEA 2007; Pelgrum and Plomp 1993). While pre-service teachers today are more skilled ICT users than their predecessors (Richards 2004; Albion 2003), it is often incorrectly assumed that they have developed sufficient skills outside their teacher education courses. The first exploratory phase of this research investigated the technologies being used by pre-service primary teachers when teaching during micro-teaching and school placement experiences.

3. Subject Matter Knowledge (SMK), Pedagogical Content Knowledge (PCK) and Technological pedagogical content knowledge (TPACK)

Effective science teaching incorporates pedagogical content knowledge (PCK) and Subject Matter Knowledge (SMK) (Shulman 1986; Cox and Carpenter 1989; Hollingsworth 1989; Appleton 1995). There is the consensus that in order to be a good teacher you not only need a strong scientific background knowledge (Shulman, 1986; Veal and MaKinster, 1999) but also a coherent understanding and a strong PCK (Cox and Carpenter 1989; Appleton 1995; Johnston and Ahtee 2006; Parker 2004). Science education programmes in ITE need to directly link SMK, PCK and Contextual Knowledge (CK) (The Teaching Council 2011).

Technological pedagogical content knowledge (TPACK) is emerging as an important area for research and development (Angeli and Valanides 2005; Lundeberg, Bergland, Klyczek, and Hoffman 2003; Mishra and Koehler 2006; Niess 2005). TPACK is the integration of the development of knowledge of subject matter with the development of technology and of knowledge of teaching and learning (technological knowledge, pedagogical knowledge and content knowledge). Integrating these different domains support teachers in teaching their subject matter with technology (Hewitt 2008; Wright 2010). Mishra and Koehler's framework for teacher knowledge emphasizes the connections and interactions, between content, pedagogy, and technology (Fig. 1). In this model, knowledge about content (C), pedagogy (P), and technology (T) is central for developing good teaching.

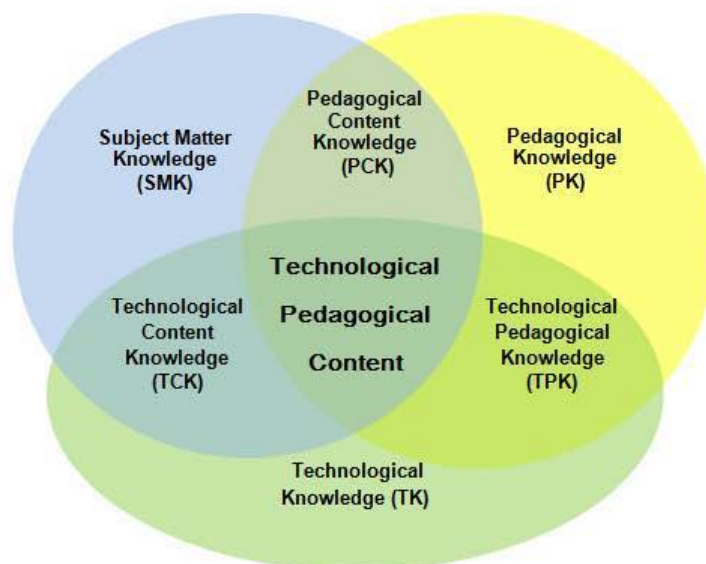

Figure 1. Graphical representation of Technological Pedagogical Content Knowledge (TPACK) (Adapted from Mishra and Koehler 2006).

4. Pre-service teachers and Technological Pedagogical Content Knowledge (TPACK)

For technology to become an integral component or tool for teaching and learning, science pre-service teachers must also develop an overarching conception of their subject matter with respect to technology and what it means to teach with technology (TPACK). Traditionally, teacher preparation programs have depended on one course focusing on learning about technology. Most teacher education institutes currently offer at least one if not a number of courses that address the need to scaffold pre-service teachers' development of expertise for ICT integrated teaching. However, many of these courses in the past focused on technological skills increasing the likelihood of pre-service teachers' using ICT in the classrooms when they became teachers (Hammond *et al.* 2009; Mishra, Koehler, and Kereluik 2009; Polly *et al.* 2010). Studies have reported that pre-service teachers are inadequately prepared for ICT integrated teaching even after the study of the above mentioned courses (Kay 2006; Mims *et al.* 2010).

Recommendations have been proposed to integrate technology in all courses in the teacher preparation program and to develop the pre-service teachers' skills in designing ICT integrated lessons (Angeli and Valanides 2005, 2009; Chai *et al.* 2010; Jimoyiannis 2010; Koehler, Mishra, and Yahya 2007; Niess 2005; O'Neill 2000). The overall aim of this research is to use an integrated approach to Science Education Modules where technology (videos) is used to enhance teaching and learning of science and strengthening pre-service teachers' SMK, PCK and Technological Pedagogical Content Knowledge (TPACK) for the modern world.

5. Aims of the research

To investigate the technologies being used by pre-service primary teachers during their teaching practice experiences.

To use an integrated approach to Science Education Modules where technology is used to further develop the students SMK, PCK and their TPACK to prepare teachers to teach where technology significantly impacts and changes teaching and learning methodologies in primary science classrooms.

6. Research Framework - Technological Pedagogical Content Knowledge (TPACK)

The science modules concentrated on the development of the students' knowledge and thinking in a manner that considers the development of an overarching conception of teaching with technology. The lectures firstly challenged the pre-service teachers to reconsider their subject matter content and the impact of technology on the development of that subject matter as well as on the teaching and learning that subject i.e. learning subject matter with technology in contrast to learning to teach that subject matter with technology (Niess 2005). Secondly the focus on technology was to use it as enrichment not as a replacement in science teaching, exploring how a technology tool could be used to foster meaningful learning i.e. combining

pedagogy and technology, developing the pre-service teachers' Technological pedagogical content knowledge (TPACK) (Tasar and Timur 2011).

7. Pre-service Teachers' Prior Experiences

This research was carried out with first year Bachelor of Education (Primary Teaching) students during their second semester of third level education in one of the largest college of initial teacher education in Ireland for elementary teachers.

When deciding on an Integrated Approach to Science Education Modules, Sandholtz, Ringstaff, and Dwyer's (1997), conceptual framework of technology integration was considered. They state that technology integration should be gradual and a slow careful approach should be taken. This framework includes five stages: *entry, adoption, adaptation, appropriation, and invention*. At the *entry phase*, teachers use technologies such as Interactive White Boards and overhead projectors. The pre-service teachers on entering third level education in their first semester would have experience of this in most modules they were taking, where the academic staff used technology in their lecture presentations. At the *adoption phase*, teachers begin to show more concern about how technology can be integrated into daily lesson plans to teach children how to use technology. The pre-service teachers would have experienced this in their pedagogy modules, where the integration of ICT would be referred to and modelled (Pedagogy of Irish, Mathematics and Educational Methodology Modules). In their first semester within the module 'Becoming a Student Teacher' they developed word processing skills, learned how to use the Interactive White Board (IWB) and screens, became familiar with presentation software and developed internet literacy. The *adaptation phase* involves the integration of new technologies into classroom practice. In their first and second semesters the students gained first-hand experience of teaching and had the opportunity to teach during their microteaching tutorials and while on school placement in primary schools using the IWB and Presentation software. In all science education lectures in semester two the Entry, Adopt and Adapt phase were considered and applied to the lecturers teaching and student learning, using technologies they were familiar with from the previous modules taken.

8. Methodology

Questionnaires were distributed at the middle of the semester when the pre-service teachers had several experiences of teaching different subject areas to investigate their use of technology in the classroom and again at the end of the semester to evaluate the integrated approach to the Science Education Modules to investigate the effect of videos on the pre-service teachers' SMK, PCK and Technological Pedagogical Content Knowledge (TPACK). 254 pre-service teachers completed the questionnaires of which 22% were male and 78% female.

9. Design and development of the videos

The pre-service teachers were then introduced to videos as a teaching and learning methodology in science. Using recording equipment and video editing software videos were designed to use in face-to-face lectures and as part of their on-line learning component of the module. The videos were designed to develop the pre-service teachers' scientific background knowledge (Shulman 1986; Veal and MaKinster 1999). The videos were used to engage students with a topic being covered, to get their ideas and prior knowledge about a scientific concept, to develop their problem solving skills by leading them to investigate a problem that appeared in the videos, to consolidate learning that occurred in the science education workshops and to promote further reflective and critical engagement with such tasks. For example they included recordings and images of science demonstrations and 'mysteries', where by the students was asked could they explain the science behind the demonstration. One such video included the use of a 'hand boiler' where by the heat from our bodies cause a liquid in the hand boiler to expand and rise upwards. Other videos had a scenario or problem posed in the video for the students to think about for example 'if you leave an ice cube on a table for 20 minutes and wrap another ice cube with cotton wool and leave it on the table also for 20 minutes, which ice cube will be the first to melt?'. The videos were also designed to develop a coherent understanding and a strong pedagogical content knowledge (PCK) incorporate PCK i.e. the delivery of science content using specific, effective and appropriate teaching and learning approaches to acquire understanding of a topic (Shulman 1986; Cox and Carpenter 1989; Appleton 1995; Johnston and Ahtee 2006; Parker 2004). For example the videos incorporated Concept Cartoons, Concept Maps, demonstrations, pictures of activities and experiments etc. that can be carried out in the classroom. The use of videos by the lecturer and the assessment component in the science education module were used as the *appropriation phase* and *invention*

phase. The *appropriation phase* is where teachers understand technology's usefulness, and they integrate it to teach science effectively in a meaningful way (Sandholtz, Ringstaff, and Dwyer's 1997). The *invention phase* involves teachers experimenting with new instructional patterns and reflect on teaching and question old patterns of instruction (Sandholtz, Ringstaff, and Dwyer's 1997). Drawing on the principles of constructivism, the pre-service teachers recorded and edited video to use in their teaching of science and designed complete lessons plans to accompany the videos focusing on the development of the childrens' scientific knowledge and scientific process skills (Willis and Sujo de Montes 2002; Brown 2002; Zhiting and Hanbing 2002; Delargey 2003; McNair and Galanouli 2002).

10. Results

Use of ICT in the primary classroom

Before this module 93% had never recorded and edited a video for teaching in the primary classroom (N=254)..

Their use of technologies in the classroom was also limited. They were asked to list any technologies they had previously used when teaching. 39% used data projectors with the majority (22%) stating they used it for powerpoint presentations, 3% used it to watch videos from you tube, 1 person used a visualiser and camera. 61% stated that they used the IWB but they did not state clearly if they used it interactively or just solely for presentations.

Experience of videos in the Science Education Module

There were then asked their opinions on the use of videos in developing their SMK and PCK. Overall the majority pre-service teachers felt that the videos helped to develop their SMK and PCK (Table 1). 71% felt the videos challenged their thinking, helping them gain knowledge and understanding in science (81%). 73% felt it also helped them to understand how to structure a lesson, providing different ideas and activities for teaching science (92%).

Table 1. Pre-service teachers' opinions of the use of videos in developing their SMK and PCK (results indicate % of 254).

Did you find the use of Videos	Yes	No	I don't know
Challenged your thinking and prior ideas on different topics in science?	71	17	12
Helped you to gain knowledge and understanding of science?	81	12	7
Helped you to understand how to structure a science lesson?	73	18	9
Provided you with ideas for teaching science?	92	6	2

Their comments also indicated that the videos engaged them in their learning, developing their knowledge and understanding in science and helped them in the planning of future lessons. Their comments included:

Engagement

They were very interesting and engaging.

They provided stimulation for students at the beginning of lessons.

The videos acted as a stimulus and engaged us in wanting to learn more.

Knowledge and Understanding

Very helpful in my learning

They were interesting and put the concept being taught into perspective.

Made the lectures easier to understand and more interesting.

I found it fun and interesting to learn on a different platform.

Lesson planning

The videos helped me to plan better science.

I thought they were very helpful as they gave great ideas for lessons and made topics interesting and engaging.

Experience of recording and editing videos for the Primary Science Classroom

IpHones were used by 81% of the pre-service teachers to record their videos, 8% used IPODs, 4% Digital camera and Video recorders and 3% IPADs.

A variety of video editing software and applications were used by the pre-service teachers: Powerpoint, Moviemaker, Spark, Splice, Video editor, Videditor, Perfect video, Video shop and Pausebutton.

They were asked to rank the effectiveness of using videos as part of their assignment (Table 2, 1: Very Effective - 5: Not Effective).

Table 2. Pre-service teachers' opinions of the use of videos in developing their TPACK (results indicate % of 254).

Rank the effectiveness of using videos in contributing to the following:	1	2	3	4	5
Developing your understanding how videos can engage children in a topic	55	33	7	2	3
Developing of your own teaching strategies	29	43	20	7	2
Using ICT to facilitate Pupil's teaching and learning in science	36	40	18	5	2
Developing your ability to structure a science lesson	34	35	24	4	4
Helped in developing your ability to engage children in a science lesson	51	33	11	2	3
Developing your understanding of how to integrate videos into the a Science Lesson	42	38	13	3	4

Their comments included:

Videos are useful overall for all aspects of teaching as well as learning.

I think the use of an engaging video immediately captures the attention and interest of the student.

I feel that using a video to prompt the children at the beginning of the lesson is a beneficial way of eliciting prior knowledge.

Helped to engage students and structure lesson.

The video was a different method of engaging the class.

It made it easier to plan a science lesson.

Using videos at the start of lessons I now find to be a great way to engage the class.

I feel videos are effective engaging children and relating them to a real life context.

Posing a problem with a video is a great way to engage children. The children became more motivated to participate in the class.

Videos overall are useful in science.

Provided a new approach.

I became aware of how to integrate videos into the classroom in an effective manner.

ICT is the way forward, children connect better with it.

I had not considered creating videos to engage children but I will in the future.

Its modern and interesting with a personal spark.

I think a video is the best was to engage pupils and this module taught me how to do it.

It gave me a good overview of ICT in the classroom.

The video was a new experience for the class and so they were engaged and interested.

Future use of videos in science lessons

65.4% stated they would now use their own videos in the primary science classroom. 6.9% stating they would not and 27.6% stating maybe.

They were then asked how they would use them in future lessons.

Table 3. Future use of videos in their primary science lessons (results indicate % of 254).

	%
Beginning of the lesson to engage and elicit discussion	97.7
To test the pupils prior knowledge	67.1
The starting point for investigations	85.5
As a form of assessment	26.1
End of the lesson to elicit discussion	56.4

As can be seen from Table 3 above the majority of students highlighted they would use videos at the beginning of a lesson to engage and elicit discussions. They also felt they would be most useful as a starting point for investigations.

11. Discussion and conclusions

This research was carried out to investigate the technologies being used by pre-service primary teachers during their teaching practice experiences and to use an integrated approach to Science Education Modules where technology is used to further develop the students SMK, PCK and their TPACK to prepare teachers to teach where technology significantly impacts and changes teaching and learning methodologies in primary science classrooms. The results from the pre-questionnaire showed that the pre-service teachers were using ICT in a very limited manner i.e. using the interactive white board to present power point presentations.

The students were introduced to the use of videos for the primary science classroom by the lecturer that designed and developed a wide variety of videos using them in lectures with the aim of developing the students' knowledge and understanding of science. Feedback from the pre-service teachers showed that the videos were successful in developing their knowledge and understanding in science. The videos were also designed to develop a coherent understanding and a strong pedagogical content knowledge (PCK) incorporate PCK i.e. the delivery of science content using specific, effective and appropriate teaching and learning approaches to acquire understanding of a topic. It can also be seen from the results that the videos provided them with ideas for future lessons, how to structure a lesson and how to use videos in the primary science classroom. Their experiences of and opinions on the assignment which required them to record and edit videos for the use in a primary science lesson further highlighted that this module contributed in developing their SMK, PCK and TPACK.

The entry, adoption and adaptation phases were very important in this research where the lecturer introduced the use of videos to the pre-service teachers and modelled this teaching methodology in her own teaching (The Teaching Council 2011). However it should be noted that the integration of technology in a method courses is not an easy task and required a high commitment from the researcher (lecturer) (Angeli 2005). Using technology in science education lectures required that the lecturer developed competences in editing digital videos. The development of future teachers' TPACK in methods courses requires that teacher educators learn to integrate technology into their own practice (Hadley, Eisenwine, Hakes, and Hines 2002). For teacher educators to integrate technology effectively into classes, they must receive appropriate training and support (Groves and Zemel, 2000). The results indicate that the task of preparing pre-service teachers to become technology competent is difficult and requires many efforts for providing them with ample of opportunities during their education to develop the competencies needed to be able to teach with technology (Angeli 2005). In future science education modules it would be important to infuse technology allow student teachers develop a sound pedagogical rationale of how to teach with technology (Mullen 2001).

12. Summary

This research shows that technology can be effectively integrated into a science education module for pre-service primary teachers however it highlights that becoming technology competent requires time and effort on both the part of the educator and student. Pre-service teachers will be able to effectively develop the competencies needed to teach with technology only when teacher educators systematically infuse technology throughout the teacher education curriculum (Angeli 2005). Programs of Initial Teacher Education need to develop a college-wide plan for technology preparation that spans both the technology and methods courses (Strudler and Wetzel 1999).

References

- Albion, P.R. (2003). Graduating teachers' dispositions for integrating information and communications technologies into their teaching. In C. Crawford et al. (Eds.), *Proceedings of Society for Information Technology & Teacher Education International Conference 2003*, 1592-1599.
- Angeli, C. (2005). Transforming a teacher education method course through technology: Effects on pre-service teachers' technology competency, *Computers and Education*, **45**(4), 383-398.
- Angeli, C. and Valanides, N. (2005). Preservice elementary teachers as information and communication technology designers: an instructional systems design model based on an expanded view of pedagogical content knowledge, *Journal of Computer Assisted Learning*, **21** (4), 292-302.

- Angeli, C., and Valanides, N. (2009). Epistemological and methodological issues for the conceptualization, development, and assessment of ICT-TPCK: Advances in technological pedagogical content knowledge (TPCK), *Computers and Education*, **52** (1), 154-168.
- Appleton, K. (1995). Student teachers' confidence to teach science: Is more science knowledge necessary to improve self-confidence?, *International Journal of Science Education*, **17**, 357–369.
- Becta (2006). *The Becta Review 2006. Evidence on the progress of ICT in Education*. Coventry: Becta (British Educational Communications and Technology Agency),
- Brown, C. (2002). Electronic portfolios in pre-service education - distinguishing between process and product. *Proceedings of the Society for Information Technology and Teacher Education International Conference*, 539-543.
- Carr, A., Jonassen, D., Litzinger, M. E., and Marra (1998). Good ideas to foment educational revolution: The role of systematic change in advancing situated learning, constructivism, and feminist pedagogy, *Educational Technology*, **38**(1), 5–15.
- Chai, C. S., Koh, J. H. L., Tsai, C.-C. (2010). Facilitating preservice teachers' development of technological, pedagogical, and content knowledge (TPACK), *Journal of Educational Technology and Society*, **13**(4), 63-73.
- Cox, A. and Carpenter, J.R. (1989). Improving attitudes towards teaching science and reducing science anxiety through increasing confidence in science ability in in-service elementary school teachers, *Journal of Elementary Science Education*, **1** (2), 14-34.
- Cox, M.J., Preston, C., and Cox, K. (1999). What Motivates Teachers to use ICT?, *Proceedings of the British Educational Research Association Conference*, Brighton, UK..
- Crompton, R. and Mann. P. (1996). *The Educational Context*. In Crompton, R. and Mann. P. (eds) IT Across the Primary Curriculum. Cassell Education , London.
- Cuban, L. (2001). *Oversold and overused: computers in the classroom*. Harvard University Press, Cambridge, MA.
- Delargey, M. J. (2003). Pedagogical Based ICT Training in Initial Teacher Education. In the proceedings of EdTech 2003, 4th annual Irish EdTech users conference, Waterford, Ireland.
- Department of Education and Skills (2011). The National Strategy for Higher Education to 2030. Report of the Strategy Group. Dublin: Government Publication Office.
- Department of Education and Skills (2001). *A Blueprint for the future of ICT in Irish Education*. Dublin: Government Publication Office.
- DfES (2005). *Harnessing Technology: Transforming learning and children's services*, DfES
- Di Sessa, A. (2001). *Changing Minds: Computers, Learning, and Literacy*. The MIT Press. Cambridge.
- Education, Audiovisual and Culture Executive Agency (EACEA) (2007). *Study of the impact of technology in primary schools*, European Commission.
- European Schoolnet (2012). *Survey of Schools: ICT in Education. Country Profile: Ireland*. University of Liege, November 2012.
- Eurydice (2004). Key Data on Information and Communication Technology in Schools in Europe. Office of the official publications of the European Communities, Luxemburg.
- Groves, M. M., and Zemel, P. C. (2000). Instructional technology adoption in higher education: An action research case study, *International Journal of Instructional Media*, **27**(1), 57–65.
- Hadley, N., Eisenwine, M. J., Hakes, J. A., and Hines, C. (2002). Technology infusion in the curriculum: Thinking outside the box, *Curriculum and Teaching Dialogue*, **4** (1), 5–13.
- Hammond, M., Fragkouli, E., Suandi, I., Crosson, S., Ingram, J., Johnston-Wilder. P., Johnston-Wilder, S., Kingston, Y., Pope, M., and Wray, D. (2009). What happens as student teachers who made very good use of ICT during pre-service training enter their first year of teaching? *Teacher Development*, **13** (2), 93-106.
- Hargreaves, A. and Fullan, M. (1998). *What's Worth Fighting For Out There?*, Toronto, Elementary Teachers' Federation of Ontario; New York, Teachers College Press; Buckingham, Open University Press.

- Hewitt, J. (2008). Reviewing the handbook of technological pedagogical content knowledge (TPCK) for educators, *Canadian Journal of Science, Mathematics, and Technology Education*, **8** (4), 355-360.
- Hollingsworth, S. (1989). Prior beliefs and cognitive change in learning how to teach, *American Educational Research Journal*, **26**, (2), 160-190.
- International Society for Technology in Education (ISTE) (2000). National Educational Technology Standards (NETS) for teachers.
- Johnston, J. and Ahtee., M. (2006). Comparing primary student teachers' attitudes, subject knowledge and pedagogical content knowledge needs in a physics activity, *Teaching and Teacher Education*, **22**, 503-512.
- Jimoyiannis, A. (2010). Designing and implementing an integrated technological pedagogical science knowledge framework for science teachers professional development, *Computers and Education*, **55** (3), 1259-1269.
- Kay, R. H. (2006). Evaluating strategies used to incorporate technology into preservice education: A review of the literature, *Journal of Research on Technology in Education*, **38** (4), 383-408.
- Koehler, M. J., Mishra, P., and Yahya, K. (2007). Tracing the development of teacher knowledge in a design seminar: Integrating content, pedagogy and technology, *Computers and Education*, **49** (3), 740-762.
- Lim, C. P., Chai, C. S., and Churchill, D. (2010). *Leading ICT in education practices: A capacity building toolkit for teacher education institutions in the Asia-Pacific*. Singapore: Microsoft
- Lundeberg, M., Bergland, M., Klyczek, K., and Hoffman, D. (2003). Using action research to develop preservice teachers' confidence, knowledge and beliefs about technology, *Journal of Interactive Online Learning*, **1** (4), 1-15.
- McNair, V. and Galanouli, D. (2002). Information and communications technology in teacher education: Can a reflective portfolio enhance reflective practice? *Journal of Information Technology for Teacher Education*, **11**(2), 181-196.
- Mishra, P., and Koehler, M. J. (2006). Technological pedagogical content knowledge: a framework for teacher knowledge, *Teachers College Record*, **108** (6), 1017-1054.
- Mishra, P., Koehler, M. J., and Kereluik, K. (2009). The song remains the same: Looking back to the future of educational technology, *Techtrends*, **53** (5), 48-53.
- Mullen, L. (2001). Beyond infusion: preservice students' understandings about educational technologies for teaching and learning, *Journal of Technology and Teacher Education*, **9** (3), 447-466.
- National Centre for Technology in Education (2004). *Schools for the Digital Age, ICT in Irish Schools, Progress Report 1998 – 2002*, Ireland.
- National Council for Curriculum and Assessment (1993). *A Programme for Reform – Curriculum and Assessment Towards the New Century*.
- National Council of Supervisors of Mathematics, (1978). Position statement on basic skills, *Mathematics Teacher*, **71**, 147-152.
- National Council of Teachers of Mathematics (NCTM) (2000). Principles and standards for school mathematics. Reston, VA: Author
- National Policy Advisory and Development Committee (NPADC) (2001). *The Impact of Schools IT2000. Report and Recommendations to the Minister for Education and Science*, Dublin: National Centre for Technology in Education, Dublin City University.
- National Research Council. (1996). National Science Education Standards. Washington, DC: National Academy Press.
- Niess, M. L. (2005). Preparing teachers to teach science and mathematics with technology: Developing a technology pedagogical content knowledge, *Teaching and Teacher Education*, **21** (5), 509-523.
- OECD (2001). *Learning to Change: ICT in Schools*, Paris, OECD.
- OECD (2005). *Are students ready for a technology-rich world? What PISA studies tell us*, Paris, OECD.
- Ofsted (2004). *ICT in Schools: The Impact of Government Initiatives Five Years On*, HMI 2050, London, Ofsted.

- O'Neill, M. (2000). Language, literacy and learning: modelling integration and reflective practices in preservice teacher education, *Teaching and Teacher Education*, **16**, 613-633.
- Parker, J. (2004). The synthesis of subject and pedagogy for effective learning and teaching in primary science education, *British Educational Research Journal*, **30** (6), 819-839.
- Pelgrum, W. J. and Plomp, T. (1993). *The IEA Study of Computers in Education: implementation of an innovation in 21 education systems*, Pergamon Press, Oxford.
- Polly, D., Mims, C., Shepherd, C. E., and Inan, F. (2010). Evidence of impact: transforming teacher education with preparing tomorrow's teachers to teach with technology (PT3) grants, *eaching and Teacher Education*, **26**, 863-870.
- Richards, C. (2003). ICT in teacher education: Some common misunderstandings and dilemmas, *IAT Teaching and Learning Bulletin*, **1**.
- Sandholtz, J. H., Ringstaff, C., and Dwyer, D. C. (1997). *Teaching with technology: Creating student-centred classrooms*, Teachers College Press, New York.
- Shulman, L. S. (1986). Those who understand: knowledge growth in teaching, *Educational Researcher*, **15**(2), 4-14.
- Songer, N. B. (2007). Digital Resources versus cognitive tools: a discussion of learning science with technology. In Abell S.K. and Lederman, N. G. (Eds.), *Handbook of research in science education*, pp471-491, New York: Routledge.
- Strudler, N., and Wetzel, K. (1999). Lessons from exemplary colleges of education: Factors affecting technology integration in preservice programs, *Educational Technology Research and Development*, **47**(4), 63-81. doi:10.1007/BF02299598
- Tasar, M. F. and Timur, B. (2011). In-service science teachers' technological pedagogical content knowledge confidence level and views about technology-rich environments, *CEPS Journal*, **1** (4), 292-302.
- The Teaching Council (2011). *Initial Teacher Education: Criteria and Guidelines for Programme Providers*, Kildare: The Teaching Council.
- Tondeur, J. Van Braak, J. and Valcke, M. (2007). Curricula and the use of ICT in Education: Two worlds apart?, *British Journal of Educational Technology*, **38** (6), 962-976.
- Willis, E.M. and Sujo de Montes, L. (2002). Does requiring a technology course in preservice teacher education affect student teachers' technology use in the classroom? *Journal of Computing in Teacher Education*, **18** (3), 76-80.
- Wright, N. (2010). *E-Learning and implications for New Zealand schools: A literature review*. Wellington: Ministry of Education.
- Veal, W. R., and MaKinster, J. G. (1999). *Pedagogical content knowledge taxonomies*. *Electronic Journal of Science Education*, **3**(4): Available at:<http://unr.edu/homepage/crowther/ejse/ejsev3n4.html>
- Zhiting, Z. and Hanbing, Y. (2002). ICT and pre-service teacher education: Towards an integrated approach. Report of the 7th UNESCO-ACEID International Conference on Education, 11-14 December, Bangkok. Retrieved July 2004 from <http://www2.unescobkk.org/ips/ebooks/documents/acidconf7/ICTPreservice.pdf>

Affiliation and address information

Dr. Maeve Liston
Lecturer in Science Education
Department of Learning, Society and Religious Education
Mary Immaculate College, Limerick, Ireland.
ww.mic.ul.ie

Associate of and Senior Research Fellow at EPI-STEM
The National Centre for STEM Education
University of Limerick

www.epistem.ie

Email: maeve.liston@mic.ul.ie

Funding acknowledgement: The Blended Learning Unit, Mary Immaculate College, Limerick.

Methods Based on Non-Formal-Learning and Emotion-Based Learning for Teaching Physics in Primary and Lower Secondary Schools.

Silvia Merlino¹, Rosaria Evangelista², Carlo Mantovani¹

¹ ISMAR-CNR, Forte Santa Teresa, Pozzuolo di Lerici, La Spezia, Italy

² Liceo Scientifico ULIVI- Viale Maria Luigia, 3 - 43125 Parma

Abstract

Teaching Physics in primary and lower secondary schools involves the choice of particular strategies and methodologies, as often the students of these educational stages lack the mathematical tools needed to formalize concepts. Furthermore, in many cases they lack the basic knowledge of many phenomena, the interest in direct observation and experimentation, the participation in the laboratory activity. Very often they have an intuitive and misleading interpretation of some concepts, which causes distortions in the learning process difficult to get rid of [Besson, 2004]. A relevant example is the physical concept of “density” (or specific weight), which is regularly confused with the mass (weight). In the case under consideration (the school-laboratory project ‘*From Archimedes to submarines: the concept of density*’) the concept of specific weight of a body is not introduced as an *a priori* definition, but as the culmination of a journey rich in discoveries and surprises: a series of experiments designed with the aim of generating an alternation of fun, emotions and moments of reflection. The choice of a non-formal didactic approach, developed in a learning user-friendly environment, and characterized by involving interfaces, gives the opportunity to create a connection between everyday experience and scholastic knowledge. In our design we have always kept in mind the results of recent research on informal/non-formal learning and emotion-based learning, which highlight how the emotional involvement of the learner is able to remove mental blocks and to activate deep structures that generate a stable knowledge [Michelini, 2006; Bachara et. al., 2000; Damasio et. al., 1994].

1. Introduction

The idea at the base of our work originates from the observation that the daily experience often leads pupils to “see” what they have around without really to “observe” the reality with careful and critical look, an attitude which would lead them to develop personal reflections, often wrong. This behaviour leads, in a later age, to misconceptions, which generate prejudiced attitudes towards scientific disciplines. Pupils often feel themselves inadequate in front of the observation of a phenomenon, inhibited to formulate explanatory hypotheses and conjectures, just because they are not familiar with the formulation of interpretative models. The subject of the educational path “From Archimedes to submarines” is the buoyancy, or better the difficult concept of “density” or “specific weight” of a body. The path is designed to deepen concepts which are often misinterpreted by children and young students (and not only by them!) because based on a misleading common sense, like: “*the more heavy the object is, much better it will sink*”.

2. Main objectives of the path

The path that we designed was initially thought to be proposed during events devoted to science popularization, such as Scientific Festivals, or occasional workshops, also performed in classroom settings, but characterized by a short duration (maximum two meetings of two hours each one). This is why we have chosen to pay particular attention to the preparation of the experiments to be presented: they had to be the most catchy and amazing, to be able to capture the interest of young people in the shortest possible time; at the same time, they should lead to acquire correctly physics concepts little known or, in many cases, wrongly acquired by students (as the concept of the specific weight, often confused with that of the weight, which is, in turn, confused with that of the mass).

Recent theories on emotion-based learning argue that the emotional involvement of children and young people during the phases of the study and learning of concepts is able to remove mental blocks and to activate deep structures that generate a stable knowledge [Michelini, 2006; Bachara et. al., 2000; Damasio et. al., 1994]. An attractive and engaging didactic path, where the playful side is structured to act as a support

to the teaching, has therefore the double advantage to attract and intrigue the learner and, moreover, to act as an activator of emotions, and thus facilitate the assimilation and the consolidation of the presented concepts.

In designing our didactic path, the original idea was therefore to introduce the fundamental concepts that we wanted to present through what we have termed "trick experiments", which somehow produce wonder and bewilderment in the pupils. The experiments have been realized using material easily available, in order to allow interested teachers and didactic operators to reproduce them. Some of them have been originally designed by the authors, while others are didactic experiments available in literature (*the cartesian diver*, the glass bottle with balloon placed in hot water, the *underwater volcano* and so on); in both cases, particular attention was given to enhance and emphasize their more spectacular aspects, and they have been inserted into a single path that introduces the different aspects of the proposed topic (the buoyancy).

An example is the experiment of the double-weighing with hydrostatic balance, a classic experiment that we try to make more interesting through the use of samples-weights of particular materials (such as nylon, aluminum, polyethylene, various types of wood etc.), whose behavior in water lends itself very well to cause misunderstandings and induce doubts in students.

This fact, which acts on an emotional level, produces a revival of interest and an increased desire to understand, and helps the child to overcome the momentary confusion of thinking, stimulating his wish for testing himself. The subsequent overcoming of the obstacle produces an effective consolidation of the concept acquired, thanks also to the increased self-esteem [Tagliagambe2011].

A further confirmation of the validity of this approach was provided to us by recent research in neurology that, like those of Damasio on emotion - based learning, are offering a scientific basis for this type of teaching strategies based on the overcoming of mistake [Roediger and Finn 2009]. In particular, results of these study suggest that the use of challenging tests - not finalized to avoid errors in the student answers - may be one key to effective learning [Kornel et.al 2009].

The idea of "trick experiments" is not new. The authors have already experienced it on previous occasions (Genova Science Festival 2009, Parmascienza 2010 Parmascienza Lab 2012, Museoland-La Spezia 2013, etc.), by means of workshops ranging from the origin of fossil fuels to the physical, chemical and optical properties of the glass [Merlino et al. 2013a, Merlino and Evangelista 2013b]. From conversation with teachers and didactic operators, we realized that the approach semi-playful and the choice of presenting more difficult concepts through trick experiments that lead students to experiment mental confusion and so to commit errors in reasoning, has proved particularly effective in increasing the subsequent scientific performance of the pupils involved in these events. But this kind of events does not facilitate the acquisition of data and documents suitable for the evaluation of the didactic effectiveness of the course. For this reason we are not able, at the moment, to produce quantitative data to validate this approach, in terms of improving of school performance of students in the treated argument.

Nevertheless, in this paper we would like to illustrate, at a qualitative level, the principal choices we made in designing this laboratory: choices and teaching strategies that, according to our experience in this area, are able to promote better learning of scientific concepts. The qualitative results that we shall describe later (in paragraph "discussion") are based mainly on our observations, made during the many laboratory implemented, on discussions with teachers and didactic operator intervened, and on output material produced by students (during the laboratory and in the evaluation phase described in next paragraph).

3. Structure of the path

Basing our choices on the IBSE/IBL methodology [Report Rocard 2007] we tried to design the structure of our path in 5 steps (following the 5E model), to promote the emergence and enhancement of the research skills:

Phase 1- Engagement(or qualitative observation of the phenomenon)

The senses play a major role in the construction of a spontaneous model. Students can freely express their opinions and observations. This phase has the aim of attracting attention, stimulate curiosity, encourage the student's feeling of "wanting to know more."

In our specific case, we give to kids everyday objects, different in shape, material and weight, and they are asked to express their a priori assumptions about their behaviour in water. After that, in order to analyze one by one the different factors that affect the buoyancy of a body in the water, we restrict initially the quantitative analysis to the "weight" (or mass): we give students a set of sample-weights, all equal in shape and volume (a cylinder of 5 cm of diameter and 5 cm of height) but different in weight and materials. As in

the previous case, students are asked to divide the objects in two categories: those that they suppose to sink, and those they suppose to float. They can handle and so estimate weight.

Their suppositions are reported in a "workbook". Materials we chose to build the sample-weights were such to cause doubt and induce the children in errors due to erroneous interpretations typical of common sense, and this is reflected in their choices. In fact, during this procedure they often find, as in the previous step, themselves in conflict with their incorrect prior knowledge: an example is the nylon sample, which in their opinion undoubtedly floats (because associated to nylon socks), and the aluminum one, which makes them in troubles because it is associated both to metal ("heavy" in common sense) and aluminum foil ("light" in common sense). From the analysis of their responses, there is indeed a predominance in assigning the full floating to the three types of wood presented (one of them instead sinks), and to have serious doubts about the behavior of aluminum, nylon and rubber.

Phase 2 - Exploration (or experimentation phase)

We ask students to perform an experiment and to verify if their previous hypotheses were correct or not. The most simple experiment, of course, is to experiment the buoyancy of the sample-weights in water. Students realize that they have made numerous errors of interpretation, and we note that they are often astonished by this fact. Many of them repeat the experiment several times, and check the sample to detect something strange in it. They appear very curious after this demonstration, and their interest to understand where their interpretation failed encourages them to continue the investigation. Often, in fact, the common sense and the inability to identify the roles of the various intervening factors induce a spontaneous model which fails in the interpretation of what is observed.

Phase 3 - Explanation (explication of the individual observation)

The purpose of this phase is to introduce and highlight, through correct scientific terms, the involved parameters and physical quantities, so that the student may be able to distinguish between those which are influential on the evolution of the event and those which are not, thus stimulating autonomous investigation of the studied context and leading him to explain the results of his investigation.

In our path, students approach this phase with the desire and curiosity to understand their previous mistakes and, in our opinion, they deal this problems with a renewed interest; in the course of our experiences we have in fact seen, at this stage, an increase of interventions, questions, suggestions by pupils, compared to the previous steps. This is especially important as it is here that are introduced to new concepts (new in particular for children of primary and early secondary school), as the concept of force, also visualized through a vector representation, and the concept of balance of forces, displayed through a real play of "tug of war": this ludic experiment with the rope is important not only to attract the attention of students, but also to visualize and consolidate the concepts just exposed.

Moreover, we designed the steps of the path in order to propose simple experiences (as the different behaviour of the samples-weights inside and out of the water) in form of trick-experiments, playing with the concept of "force of gravity that acts on all bodies" and "push of Archimedes that acts on all bodies immersed in water", and with their role and efficacy inside or outside water. Here, the ability of the tutor is important: posing the right questions at the right time during a simple experiment like this, it is possible to lead most children into error about the behaviour of some sample (example in Figure 1); the reaction, in front of the evidence that contrasts with their expectations, triggers a process of reworking of the error in the light of what was experienced, and produces the actual understanding of the concept of "balance of forces". Later, if finding themselves in similar situations during the course of the laboratory, those mistakes do no more occur!

During this phase we introduce, also, the concepts of mass, weight and volume, stressing the difference between mass and weight, and calling the attention to the role that the volume has in determining the behavior of objects immersed in water (so, not only their weight is important!).

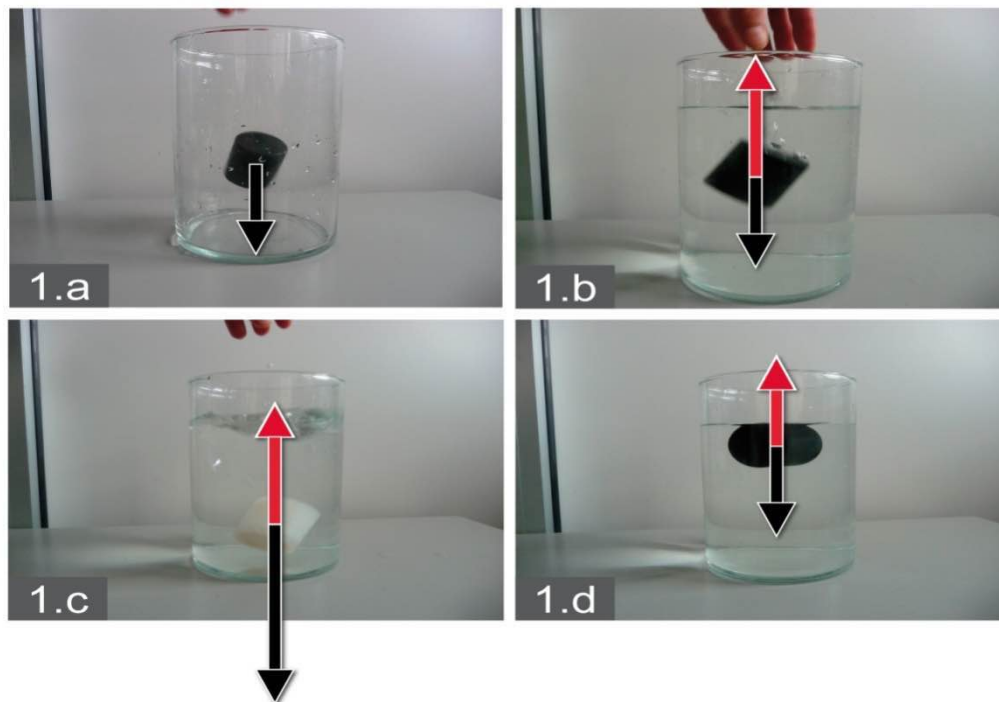

Figure 1. Even a simple experience of buoyancy can be presented to students in form of trick experiment: many students are in difficult in putting together what they just heard from teacher/expert voice (i.e. that the push of Archimedes acts on **all** the bodies immersed in water) with what they see during the experiment. In fact, the polyetilene-sample, in the empty jug, falls due to gravity (Fig1.a), while in the jug full of water initially it sinks, but quickly moves upward, showing with evidence the presence of an upward force (Fig.1.b). On the contrary, nylon or aluminum go deep also in a full jug (Fig1.c), and for many of the students this is unequivocally a demonstration of the absence of the push of Archimedes! Thanks to the experiments they will do after this (i.e. , during phase 4), they will be able to understand their initial error, and to interpret the phenomena in terms of balance of forces (Fig.1.d).

Phase 4 – Elaboration (or critical review)

This phase, based, as the previous, on the methodology "hands - on, mind - on" , consists of a second series of experiments aimed to disprove perceptions or erroneous interpretations, to break prejudices and to validate positive conjectures.

Here children are invited to validate concepts encountered during previous phases through quantitative experience, as the double-weight experiment with hydrostatic balance, using sample-weights of different material and equal volume, and also with samples of the same material but different volume. Taking into account that it is not only the weight of an object to be relevant for understanding its buoyancy, but also the volume has an important role, the didactic path leads, in a logic way, to the definition of a new quantity (specific weight), necessary to understand the behaviour of bodies in water. The concept it is not given *a priori*, but emerges as a result of the experimental path and, once acquired, enable students to understand many natural phenomena often erroneously explained by common sense (see the next phase for details).

The next step is to speak about buoyancy in liquids, not only in water. Some trick-experiments help in this task, through the use of common liquids (oil, glycerin, alcohols etc.) with different specific weight. (Fig. 2)

Phase 5- Evaluation (or Formal organization of thought/transformation of knowledge in competence)

At this time a real problem is submitted to the kids, in the form of an investigative question. In order to solve the problem they have to put in place all the acquired knowledge, consistently correlated. Students are asked to explain, in the light of what they saw and learned in the previous phase, some natural phenomena: from floating pumice stones and stratification of liquids with different density to the aerostatic balloons.

The correct acquisition of concepts introduced during previous phases is absolutely necessary and preliminary to this part of the laboratory, as the concept of density (or specific weight) is crucial in these cases in which weight and volume of the fluids we compare are not defined (Fig 2). And again: for the third state of the matter, can we apply the same rules? Can we still speak of "buoyancy" for gas in liquids, or gas inside other gases? These are the questions that students are asked to answer, using concepts and terminology acquired in the previous phase.

This is perhaps the most surprising and amusing part of the path, particularly reach in experiments that often appear as small "magic tricks" or "sleight of hand" to the eyes of the students. It is an important phase for them: they realize to be able to give a logical explanation to phenomena not previously understood or incorrectly explained, or to experiments that initially seem magic tricks but that, when analyzed, are instead easily understood.

The laboratory ends by posing two open questions at students: the first is: "what determines the density (or the "specific weight") of an object? Some of the last trick-experiments concern stratification of liquids with different temperature and salinity, and also the different behavior (and specific weight) of materials in their different states (example. ice, liquid water or vapor) (Fig 2). We let the students give us an explanation of that and arrive to the correct conclusion: it depends not only on the constituting material, but also on its chemical structure and its temperature. The second question is: "can we change the density of a body (solid, liquid or gas)? Which could be the consequences? Showing examples taken from nature and human artifacts, in which these principles are exploited, and building small exhibits with cheap material, we shows that it is possible to answer to this question and moreover we suggest to the students an investigative method to read the scientific principles hidden in natural phenomena that appear incomprehensible. The concept of density deals, in fact, with many of the apparently mysterious phenomena we see every day: how do fishes and submarines move upward and downward inside water? How do balloons and hot-air-balloons float in the air? The children learn that they are able to coordinate their knowledge and insights to address and solve problems, not necessarily related to schoolwork but also questions and issues resulting from their personal curiosity (Guile and Griffiths 2001). And, we believe, this is a very appropriate definition of "skills acquisition".

Moreover, according with the non-formal learning environment in which we operate, we decided to propose, to students, particular evaluation methods, like the setup of theatrical representations; here students propose the path of the laboratory to the general public, emphasizing the more entertaining and funny aspect of the experiments. For the children it was a special time of consolidation of the acquired concepts, since the presentation to the public had to be made by themselves. The experiment has involved one class of secondary school in Parma (Emilia Romagna) and two classes of primary school in Sarzana-La Spezia (Liguria) in 2012, and we think it can be a validation instrument of undoubted value for education and training, perhaps not always easy to use.



Figure 2. Some of the experiments, looking like "magic tricks", introduce the behavior of liquid mixtures with different densities, gases inside liquids and gases inside other gases.

4. Discussion

Basing on the analysis of what is reported in students workbooks, on questions and discussions that inevitably follows the trick experiments performed (sometime we have registered the student conversations), on teacher reports and especially on the experience of the set up of theatrical representations (during the "evaluation phase"), we were able to elaborate some preliminary considerations about our didactic approach.

As regard to methodology and teaching strategy that we applied, two important results emerge:

- Stimulus based on surprise, wonder and bewilderment is a powerful activator of interest and inevitably leads to the will to overcome the (eventual) initial error of interpretation of a phenomenon: the misconception have to be removed in order to understand where is *the trick*. This step is a fundamental cornerstone in the cognitive process and ends with the understanding of the phenomenon.
- The former achievement is essential for correct acquisition and consolidation of knowledge, and for this reason it is important to project didactic paths that allow students to reach independently (i.e. without a superimposition of the teacher) the understanding of the concepts and strengthen self-esteem.
[" *People can be convinced more easily by reasons that they discovered by themselves than by those arising from the mind of others.* "Blaise Pascal]

In fact, the observation of the phenomena always induces interpretation of them, even when the individual is not aware of it. This interpretation is affected by complex factors of personal experience, sometimes incorrect, that have proved to be very difficult to remove if they are not put in crisis due to conflict situations: only in this case, in fact, the student experiences the need to overcome them, with the result to change his/her mental attitude. Moreover, for students it is important the "social dimension" of the spontaneous interpretative hypothesis, and the comparison between their ideas and those of their fellows, in a sort of peer discussion that should lead to the construction of shared logical models. This fundamental phase leads to understand the difference between "to state" and "to argue" and, in our experience, generates the mental attitude of acceptance of an idea, not through its imposition, but through motivated criticism.

This phase is also crucial in the structuring of a learning model, because it persuades the kids to understand that a mistake is not a definitive failure, as it may induce useful discussion for the construction of a proper knowledge, highlighting the epistemological obstacles or misconceptions that come from their own personal experience. The mistake is then considered under a different light: as one of the steps of the cognitive process [Tagliagambe 2011].

For this reason is it important to enhance and to address this method, without transgressing it through the imposition of predefined concepts. Such approach has been proved to be effective especially for the implementation of the labs for primary school children, where the discussion of the phenomena and the verification *on the field* of different interpretative models are very important. This has proved to be of particular interest to us, as we had the opportunity to test the students' understanding level on these concepts, without the contamination of a superimposed scholastic knowledge, due to the fact that they are not inserted in scholastic programs for this age range.

In particular, it appears that some fundamental concepts, concerning the argument that we have treated, have been badly acquired or misinterpreted - following an erroneous common sense - by most students. Especially:

- A- The concepts of "light" and "heavy" often may be misinterpreted. They should be gradually replaced, in the children vocabulary, with those of "less dense" and "more dense" respectively.
- B- The buoyancy of a solid body inside water is often put in relationship only with its weight or with the material that is made of, without considering other factors, like its volume or shape.
- C- Among all fluids, water is assumed to be the only one to be considered for the evaluation and comparison of the solid bodies density.
- D- The behaviour of liquids inside other liquids is considered a totally different phenomenon respect to the behaviour of solid bodies inside liquids, therefore in the former case the principles and concepts applicable to the latter case are not recognized as valid.
- E- Even after understanding the Archimedes principle and therefore the buoyancy of bodies in terms of balance of forces, this concept is rarely considered to be valid in situations different from those with which children are familiar (solid and liquid): the physical medium "gas" is not perceived as a possible replacement of a "liquid".

5. Conclusions and future improvements

The described laboratory, thought to be carried out during educational or popular-science events, have been proposed, since 2009, in different contexts, (not just non-formal but also informal, as Festival della Scienza di Genova 2009, Parmascienza 2010, ParmascienzaLab 2012, Museoland-Spezia 2011, Festa della Marineria 2013-La Spezia), in order to build up the best strategies "for activating experiences to understand phenomena in playful contexts" (Michelini 2006). In these contexts the laboratory has been much appreciated from the students, as well as from the involved teachers/operators (private communication, and report of ParmascienzaLab results, in Bianucci et al. 2013).

During the many of the laboratory we realized the validity of the learning strategies adopted, especially the set up of trick-experiments, that intrigue and attract students, help to overcome the errors arising from erroneous common-sense explanations and, through this process, lead to the consolidation of the learned concept. Moreover, we have been able to detect the most common mistakes due to common sense misinterpretation (reported in the "discussion" paragraph), so to identify which are the more sensible parts to deal with for an effective introduction of the concepts of buoyancy and specific weight.

We think that this approach, experimented in non-formal and informal environment, could be valid also in a formal-learning environment, as scholastic path, and it could be useful to introduce and consolidate concepts of physics, often not included in the school programs of students of that age (primary schools), or otherwise treated only marginally, but (in our opinion) very important in order to understand many of the natural phenomena that are experienced in everyday life.

However, to use our laboratory path in a formal-learning environment, it should be essential to have an appropriately designed validation protocol, which could consent to check whether the use of such a laboratory actually afford an understanding of the concepts better than that afforded by traditional methods (lectures or even use of educational standard workshops). Unfortunately, at the moment we have not elaborated a similar instrument. It is our intention to do that, basing the elaboration of such tool also on the results of our experience.

For example, our experience has led us to confirm that the children of primary school age don't want to passively accept what they are told, but they ask for a demonstration of what is asserted by the teacher. In contrast, secondary school students (11-14 years), despite having a greater acquaintance with complex scientific concepts, show lower interest in the experimental activity and greater tendency to assume concept passively, often avoiding the discussion and comparison. A recent research on science perception performed by the Working Group for Science and Education of La Spezia - established by the 5 Research Centres and the technological public/private cluster settled in the city of La Spezia - confirm this trend [Locritani et al 2015].

Moreover, this kind of approach can be useful to stimulate interest in those children/young people who generally demonstrate, in class, poor motivation or will to learn. According to private conversations with many of the involved teachers, we found that this type of educational approach awakens interest in those children who work with great difficulty during classroom lessons. In this regard, our laboratory has been included, for scholastic year 2014/2015, in the project "Crescere in armonia/Grow with harmony", funded by MIUR (Ministry of Public Education) and devoted to combat early school leaving, which was recognized by the EXPO 2015 [Crescere in armonia 2015].

These considerations led us to interact with Working Group for Science and Education of La Spezia, in order to evaluate, with their methodology [a recent inquiring protocol, based on specific questionnaires and statistical validation methodologies, in Locritani et al. 2015], the validity of our non-formal teaching strategies, especially for stimulating a change, in a positive sense, of science perception in secondary school students; the first results will be available, to be processed and analysed, at the end of scholastic year 2014/2015.

Moreover, with the aim of investigating also the effective validity of this approach to favour the skill acquisition by students, we are elaborating quantitative methods aiming to compare our strategy with the standard teaching methodology (lectures), through special questionnaires to be used during the next scholastic year (2015/2016) in primary and secondary school of La Spezia province and Parma province.

The hope is to quantify, by means of well-defined indicators, the impact that these didactic methods have in different educational settings, in line with what has already been carried on for other disciplines (Stroobant et al. 2014, Merlino et al. 2014).

All the images of this paper have been printed with the approval of the student parents, through a special consent form signed by them.

References

- Bechara A., Damasio H., et al., (2000) Emotion, Decision making and the orbito-frontal cortex, *Cerebral Cortex* **10,3**, 15-21. Oxford Univ Press
- Besson U. (2004), Some features of causal reasoning: common sense and physics teaching, *Research in Science & Technological Education* **22 (1)**, 113-125
- Bianucci M, Merlino S., Evangelista R., Mantovani C., (2013). Una partecipazione eccezionale. In: Catalogo ParmascienzaLAB 2012, ed Edicta, Parma, ISBN 978-88-89996-55-7, pp 49-55.
- Crescere in armonia Project(2015).
(<http://www.comune.parma.it/notizie/comunicati/SCUOLA/2015-02-27/Crescere-in-Armonia-Educare-al-BenEssere.aspx>)
- Damasio A.R. and Macaluso F. (1994), *Descartes' Error: Emotion, Reason and the Human Brain*. In Random House (Ed.). New York, NY: Grosset/Putnam.
- Guile D., Griffiths T., (2001), Learning through work experience, *Journal of education and work*, **14 (1)** pp. 113-131.
- Kornell N., Matthew J.H. and Bjork R.A. (2009). Unsuccessful Retrieval Attempts Enhance Subsequent Learning. *Journal of Experimental Psychology: Learning, Memory, and Cognition*, Vol. 35, No. 4, 989–998.
- Locritani, M., Talamoni, R., Stroobant, M., Guccinelli, G., Benvenuti, L., Abbate, M., Batzu, I., Benedetti, A., Bernardini, M.I., Carmisciano, C., Casale, L., Centi, R., Furia, S., Giacomazzi, F., La Tassa, H., Marini, C., Merlino, S., Mioni, E., Muccini, F., Nacini, F., Tosi, D., Vannucci, C. (2015). Feeling the pulse of Public Perception of Science: does Research make our hearts beat faster? In Proceedings of OCEANS'15 MTS/IEEE Conference: Discovering Sustainable Ocean Energy for a New World (paper in press). IEEE.
- Michelini M. (2006). The learning challenge: a bridge between every day experience and scientific knowledge, in *Informal Learning and Public Understanding of Physics*. In: Planisic G., Mohoric A. (Ed.), *Girep book of selected contributions* (pp 18-39). Ljubljana: University of Ljubljana.
- Merlino S., Evangelista R. and Mantovani C. (2013a). Carbon and fossil oil formation, glass properties...the secret is to amaze! In: Proceedings of European Geosciences Union General Assembly. Wien: EGU 2013, 7-12 April.
- Merlino S., Evangelista R., (2013b). Come nasce un laboratorio? In EdictaEd., *PARMASCENZALab 2012*, (pp 57-60). Parma, ISBN 978-88-8998-55-7
- Merlino S., Stroobant M., Locritani M., Talamoni R., Furia S., Muccini F., Abbate M., Nacini F., Mori A., Carmisciano C. (2014) Alla scoperta dei tesori del mare". *Scienza e tecnologia, memoria popolare e identità culturale in una città della costa ligure. Miscellanea INGV*, **22**, 7-21, ISSN 2039-6651
- Report Roncard 2007: http://ec.europa.eu/research/science-society/document_library/pdf_06/report-roncard-on-science-education_en.pdf
- Roediger, H.L. & Finn, B.(2009). Getting it wrong: Surprising tips on how to learn. *Scientific American Mind Matters*. Retrieved from <http://www.scientificamerican.com/article.cfm?id=getting-it-wrong>
- Stroobant M., Mori A., Merlino S., Bianucci M., Delfanti R., Furia S., Carmisciano C., Locritani M., Muccini F., La Tassa H., Talamoni R., Nacini F., Benedetti A., Nardi E., Parodi A., Giacomazzi F., Mioni E., and Associazione Festival della Scienza.(2014). A new protocol in La Spezia for elementary and secondary school students for monitoring Perception towards Science and Performance in Science Classrooms. *Proceedings of EGU General Assembly*, Geophysical Research Abstracts Vol. 16
- Tagliagambe S. (2011) Un nuovo ambiente di apprendimento: come sviluppare un raccordo coerente fra competenze e conoscenze". *Atti del convegno ANDIS 2011*. Bologna.

Affiliation and address information

Silvia Merlino
 ISMAR-CNR, U.O.S. La Spezia,
 Forte Santa Teresa,
 Pozzuolo di Lerici,
 19038 La Spezia.SP
 Italy
 e-mail: silvia.merlino@sp.ismar.cnr.it

The Persistence of the Alternative Conceptions: the Case of the Unipolar Model

Abdeljalil Métioui¹, Louis Trudel²

¹*Université du Québec à Montréal, Montréal, Canada*

²*Université d'Ottawa, Ottawa, Canada*

Abstract

This article identifies the alternative conceptions of 88 students in teacher training for primary school with regard to the notions of open and closed circuits. For this purpose, we constructed a questionnaire with two choices (true or false). In order to identify their conceptions, we asked them to justify their choice of answers. The analysis of the data demonstrates that for most of them, the electric current can circulate in an open circuit. This conception belongs to the unipolar model and according to several researches, the pupils abandon this conception in the case of a simple circuit composed of a bulb, a battery and electric wires for operative reasons. Thus, we observed the persistence of this model when one questions students on the working of more complex circuits.

Keywords

Primary, student' teachers, alternative conceptions, persistence, unipolar model

1. Introduction

Several studies achieved among others in France, in England, in Italy, in Finland, in Australia, in Canada and in the United States demonstrate that the conceptions of the teachers of the primary schools, as well as their pupils, on the basic notions in fields of physics, chemistry and biology are erroneous, compared to those commonly accepted by the scientists (Métioui and Baulu Mac Willie, 2014; Métioui and Baulu MacWillie, 2013; Métioui and Trudel, 2012; Pilatou and Stavridou, 2004; *Furió*, Guisasola and Almudi, 2004; Henriques, 2002; Valanides, 2000; Canãl, 1999; Sharp, 1996; Webb, 1992) For example, in the case of the working of an electric circuit constituted of a battery, a bulb and two electric wires, several of these works demonstrate that majority of pupils explains its working while referring to the following models: (3) the unipolar model (the current leaves from the battery (either positive or negative) and arrive to the bulb; thus, the wire back toward the battery is considered as superfluous or passive), (2) the attenuating (or dissipative) model (in which the currents leaves one terminal of the battery and is partially consumed in the bulb, so that a lesser current returns to the battery), (3) the model of clashing currents (both a positive as well as a negative current meet at the bulb and “clash” causing the bulb to light, and (4) the sharing model (each of several components receives its share of the current; identical components receive and consume identical currents. These spontaneous models are relatively erroneous to the scientific model postulated that every portion of a closed circuit is crossed by the same current. Other works led this time on high school students having followed scientific teaching with regard to the working of electric circuits demonstrated that the unipolar model continues to nourish the speech of these students (Closset, 1983, Shipstone, 1988; Jabot and Henry, 2007; Stanton, 1990). It seems that this model lasts among some students frequenting the first academic year (Fredette and Lochhead, 1980; Arons, 1982) and secondary school (Mackay and Hobden, 2012).

About the persistence of this model, Tiberghien (1983), Tasker and Osborne (1985) and McDermott and Shaffer, 1992) underlined that the majority of the pupils abandons this erroneous model during the training of the electric circuits and that the one that persists the more to the teaching is the model of the current that is attenuated. Let's note to this topic that very few research have been done in order to insure that in fact, the pupils abandon this model more easily. The present research, of qualitative type, appears in this view and serves to identify the alternative conceptions of Quebec (in Canada) future teachers on this unipolar representation. Besides, the survey of electric circuits been part of the curriculum in the primary school of Quebec, as in several countries.

2. Sample, context

Research has been achieved in the setting of a formation carrying on the didactics of the sciences. The sample was constituted of 88 students; their majority are female and registered in second year of the program in elementary education. The middle age was of 22 years and the majority followed a course on the electric circuits during their secondary studies. They are all possessors of a diploma of collegiate studies in liberal arts.

3. Methodology

To identify the conceptions of the students with regard to the unipolar model, we distributed them a questionnaire of a length of 60 minutes including five questions. For each, they had to answer by true or false, while justifying their choice of answer, what was indispensable to identify their conception. Thus, in a first time, we compiled the answers, a question at a time, each taken separately. Then, we conducted their regrouping in distinct categories, the number of which being variable from one question to the other, according to the different advanced answers. Let's note that the answers found to reoccur have been grouped into the same category, following Gilbert and Watts (1983):

“To generalize beyond the individual is to construct groupings of responses that are construed as having similar intended meanings. This is to construct a category of responses commonly in the context of single, or specific, sets of questions.” (p. 69).

So, the analysis of the answers started by the distinction between those that are correct, partially correct or incorrect and those that are indecipherable. To qualify the answers of correct, partially correct or incorrect, we compared them to those presented to the section below.

4. Construction of the questionnaire

The questionnaire included five questions (see annex 1) carrying on the notions of open circuit and closed circuit. Several of these questions have been presented in other research and we rephrased them slightly. The first served to know if there is an electric current that circulates in the electric wires leading to a lamp, knowing that its filament is broken and that the switch is in position "on". In these conditions, no current circulates in the filament since the circuit is open. The second was about a circuit composed in series of two bulbs in series of which a bulb that normally illuminates and another one that doesn't illuminate. One wanted to know if, the bulb that doesn't illuminate is burnt. This situation concerns two bulbs that don't have the same characteristics, what explains that one functions and the other no. This last "cannot be burnt" since the circuit is closed. The third question was about a circuit composed of two branching of which one is closed and contains a bulb and the other is open and contains two bulbs. The question was to know if the three bulbs could shine with the same intensity if they were identical. Evidently, it is not possible since in the open branch, the bulbs will be extinguished. In the circuit of the fourth question, the bulb is connected to the positive pole of a battery and to the negative pole of another and so, the circuit is not closed. Therefore, it won't work.

Finally, with regard to question 5, the B bulb of the circuit 2 won't work, as in the case of the fourth question, because the circuit is not closed. However, with this question we wanted to know, for the students for whom a bulb will light if it is plugged between the positive terminal and the negative terminal of two batteries that are not joined together, if the electric potential difference of every battery will influence the lighting of the bulb and if yes, how.

5. Analysis of the questionnaire

The analysis of the results allowed us to demonstrate the persistence of the unipolar model of the majority of the participants. Below, we present the analysis of each question.

Analysis of question #1

In the case of this question, 18% (16/88) of the students advanced a correct answer: no current flows in the wires, because the circuit is open since the filament of the lamp is burned. Below, some students' justifications:

“The current won't flow, because the circuit is open.” (e40)

“The current must leave from one point and come back to the same point. In this case, the current cannot complete the circuit because the filament of the lamp is burned.” (e49)

“In order to say that there is a current flowing in a circuit, the current should flow throughout the circuit from one point and come back to it. However, since the circuit is open there is no flow of current.” (e69)

For the majority (82%), there is a current in the wire leading to the bulb, even though its filament is grinded. For several, the current is present in the wires since the switch is open. Thus, the analysis of data has permitted us to identify 2 erroneous conceptions. Below, percentages of each conception, as well as some justifications:

Conception 1 (52/88 - 59%): The switch is "on", therefore the current flows in the wires leading to the lamp (unipolar model)

“If the switch is "on", it means that there is flow of current in the electric wires, even though the bulb is burned.” (e3)

“The current is always there as far as the switch is "on". The lamp is just a breakage. So, if you touch the connecting wires, you will feel the electricity.” (e10)

“The connecting wires carry current up to the bulb. If there is over flow of current, the filament of the bulb will burn.” (e20)

“I believe that the electric current flows in the wires but can't flow through the bulb, because it stops right before it.” (e21)

“Of course, this is why you should turn off the switch before changing the bulb.” (e36)

“If you replace the bulb with a new one, the new bulb will light without changing the position of the switch.” (e79)

“The filament is burned, but the current continues to flow when the switch is "On". (e87)

For these students, the current flows through the cables and stops at the beginning of the bulb because the filament is burned. Thus, the current moves from the current outlet to a point of the circuit. It is the unipolar model.

To justify the presence of this current, it is sufficient to remove the bulb, to put our fingers there and one will feel its effect. For other students if the lamp is replaced by another one without touching the switch, the new lamp would light automatically. These students don't know that one connecting a new bulb, it illuminates because one has just closed the circuit and not because the current was in the wire since the switch is in position "On".

Conception 2 (20/88 - 23%): The lamp does not light because its filament is burned. Despite this fact, the current continues flowing through the lamp.

“The current flows because the switch is "On". The current passes through the bulb, but the lamp doesn't light because the filament is burned.” (e13)

“Although the filament of the lamp is burned, the current still flows through the lamp.” (e18)

“Since the filament is burned, the bulb won't light but the current will still pass through.” (e50)

“Yes, the current flows in the wires but the bulb cannot light because the filament is burned. This doesn't change the fact that the current flows in the wires.” (e52)

“The fact that the bulb doesn't work is referred solely to the burned filament. The switch is "On", and the current continues to flow.” (e54)

“Even though the lamp is burned, the electric current flows in the wires, it is just that the bulb doesn't have to light.” (e65)

“When the filament is burned, the current will flow in the shell casing the bulb.” (e74)

These students, don't seem to make the difference between a conductor and an insulator since, according to them, the current continues to move through the bulb. On the other hand, they didn't refer to the unipolar model since, according to their reasoning, the current continues to circulate, even though the filament is burnt. Their confusion is probably related to the fact that they don't know the principle of the mode of the construction of the bulb (e74).

Analysis of question #2

As for the second question, 23% refer implicitly or explicitly to the bipolar model to justify their answers. For 17 %, their answer is correct (the bulb cannot be burnt otherwise the circuit would be open):

“To claim that the circuit is functioning, electricity must flow throughout the circuit, therefore bulb B cannot be burned.” (e19)

“Perhaps the battery is down because it has used all of its energy to light bulb A. Therefore, the battery could not supply bulb B with enough energy. If bulb B is burned, the whole circuit would not work.” (e40)

Some students justified their answer while indicating that in the case of a parallel circuit, one could have a bulb which works and another burnt and no in the case of a circuit in series:

“In this case, if bulb B is burned, bulb A would not light. However, if the two bulbs are connected in parallel and bulb B is burned, bulb A would not be effected and remain light.” (e64)

The other students (6%) advanced erroneous justifications in referring to the model of the current that is attenuated. For them, the bulb B it doesn't illuminated because the bulb A take a big part of current (attenuating model).

“Bulb A has consumed most of the total current, and therefore there is insufficient current to light bulb B.” (e5)

“It is just that the bulb A consumes the whole current coming from the battery and that there is not some unfortunately enough to light the B bulb.” (e18).

“Maybe the power of the battery doesn't match with that of bulb B. If bulb B is connected to a battery of low power, the bulb will not light.” (e15)

“Not necessarily, it is possible that the value of the electric current is not enough to lighten bulb B.” (e88)

For the majority (77%), the B bulb doesn't light because (1) it is burnt, (2) it is connected improperly, (3) the connecting wire that joins bulb A and bulb B is disconnected or (4) the current is not enough to flow in the whole circuit:

“The current should flow, therefore if it doesn't illuminate that is that it is burnt.” (e1)

“Maybe bulb B is burned, and maybe that it is the reason for the deficient thread.” (e2)

“Bulb B is going to receive less current than bulb A. This current will allow bulb B to light, but with less brightness. If bulb B doesn't light, it should be burned or the current is not strong enough.” (e24)

“Either bulb B is burned, or bulb A has used the whole current to remain light.” (e35)

“It is uncertain whether bulb A demands all energy from the battery to light.” (e52)

“Perhaps bulb A used up the total current, and there is no current left to light bulb B.” (e62)

“Maybe bulb B is burned, or the wire between the two bulbs does not allow flow of current.” (e65)

“Because the negative side of the battery has as much current as the positive side.” (e68)

“Bulb B is not necessarily burned. It might have a poor connection.” (e86)

These justifications demonstrate the persistence of the unipolar model that stipulates that a current circulates from the positive terminal of the battery to the bulb and stops there. As for the B bulb, it doesn't function: because either it is burnt, badly connected or that the whole current has been used (consumed) by the bulb (attenuating model).

Analysis of question #3

Only 20% advanced a correct answer. The bulbs B and C won't work, because it is an open circuit.

“Only bulb A will shine, because the short circuit makes no current reaches bulb B or bulb C.” (e40)

“Only bulb A will shine because it is the only that makes closed circuit.” (e48)

“Only A will shine because it is the only one that is part of a complete electric circuit.” (e63)

“Bulbs B and C won't light because they are not in a closed circuit.” (e69)

For 80% of the students, the current produced by the battery will cross the bulbs A, B and C and so they will illuminate. On the other hand, with regard to the intensity of their brightness, we identified four categories of answers:

- (1) A illuminates more than B and C,
- (2) A illuminates less than B and C,
- (3) C illuminates less than A and B
- (4) A, B and C will have the same lighting.

The conceptions that underlie each category as well as their percentages and some examples of students' answers are presented below:

Conception 1 (13/88 - 15%): Bulb A will shine with more brightness compared to bulbs B and C because it is joined to two places of the battery.

“Bulb A will light brighter because bulbs B and C don't have a connecting wire on one end.” (e67)

“Bulb A will shine more because it is connected to the battery at two points, while bulbs B and C are connected at one point.” (e17)

“I believe that bulb A will shine more than bulbs B and C, since it's connected to the battery; whereas, bulbs B and C are disconnected at a point.” (e43)

“Obviously bulbs B and C are out of power, versus bulb A that is directly on the conductive line.” (e62)

“Bulb A is going to shine with more brightness, because it is connected by one wire that carries the total current from the battery. In case of bulbs B and C, the electric current is carried by two wires, therefore they are dimmer.” (e65)

“Bulb A will light brighter because bulbs B and C don't have a connecting wire on one end.” (e67)

“Bulb A will light brighter since it is connected from two points by an electric wire carries the current, whereas bulbs B and C have less current because the wires are not connected.” (e84)

Conception 2 (6/88 - 7%): Bulb A will shine less than bulbs B and C because it is far away from the battery. These students, refers simultaneously to the unipolar and attenuating model to explain the working of the bulbs A, B and C.

“Bulbs B and C are going to light brighter because they are closer to the battery. Therefore, bulb A will receive less power.” (e11)

“Bulbs B and C will be brighter than bulb A, because the electric current will reach them first.” (e20)

“The further the bulb is from the battery, the lesser the energy it receives. Therefore, bulbs that are away from the battery always light dimmer.” (e44)

“I believe that bulbs B and C are going to shine more because their wire don't connect. Therefore, the current would be higher.” (e82)

Conception 3 (15/88 - 17%): Bulb C will light less than bulbs A and B because the current leaving the battery is divided between bulbs A and B, and then the current passes through bulb A will cross bulb C (unipolar model).

“It would be necessary to determine the positive and negative terminals of the battery. If the negative pole is on the left, bulbs A and B will shine brighter than bulb C.” (e5)

“Let's "imagine that the positive pole of the battery is on the left. The current will split equally at a junction between bulbs A and B. However, bulb C that is far away from the positive pole will be dimmer.” (e21)

“Bulb C will be dimmer since it is connected in a parallel circuit. The current will split between bulbs A and B, and the remaining current of bulb A will separate before going toward bulb C.” (e27)

“Bulb C will shine with less intensity because it will receive less electricity than bulbs A and B.” (e28).

“Bulb C will shine probably stronger than the other two because the current will first pass through bulbs A and B. On the other hand, I believe that bulbs A and B will shine similarly because they share identical currents.” (e30)

Conception 4 (25/88 - 28%): Bulbs A, B and C will shine with the same brightness because the current will be equally distributed between them.

“They receive the same current. They are plugged to the same battery and they are identical bulbs.” (e3)

“As they all are connected to the same circuit, they will have the same brightness. If wires B and C were very long, bulb A would have shined more strongly.” (e50)

“Even though the two wires of bulbs B and C aren't in contact, the currents + and - of the battery flow to the bulbs. Then the bulbs will shine with similar brightness.” (e79)

For 7%, the brightness of the bulbs depends on (1) the charges of the battery, (2) the length of the connecting wires, or (3) how far the bulbs are from the battery:

“All depends on the electric charges received and the length of the trajectory.” (e31)

“It goes depends on the strength of the electric current that passes in every bulb.” (e33)

“It depends on the current and the distance between the battery and every bulb.” (e35)

Finally, 6% of the students advanced incomplete or indecipherable justifications while affirming that the B and C bulbs light up.

“There will be a power loss due to the path of electricity. The 3 bulbs won't shine with the same intensity.” (e25)

“According to me, the site of light on the electric circuit plays a role. The current may not be the same everywhere.” (e51)

“Bulb A will receive less current because the current returns from bulbs B and C intersection will divide into two.” (e59)

Closset (1983) asked the same question to students in a group (16-19 years old) and noted that for 18% among them, the three bulbs are equally lit, because electrical current flows through every wire. These students, refer simultaneously to the unipolar and sharing model in the circuit.

Analysis of question #4

Only 33% of the students affirm correctly that it is about an open circuit and that it would be necessary to join the two other poles of the two batteries by a wire so that the current circulates:

“There is a gap between the two batteries. If the wires would have been in the (-) pole of the battery, the circuit would work.” (e19)

“It is necessary to connect the 2 batteries with a wire to form a complete circuit.” (e7)

“The electric current flows from (+) to (-) when it reaches only one battery.” (e10)

Thus, according to 67% of the students, the bulb will light since it is joined to the positive pole of a battery and the negative pole of another, no matter if the two batteries are not joined together. This false conception probably ensues from their experience when they place a battery after another in a pocket-size lamp, for example. These students know the relative convention with respect to the circulation of the simple electric current in a circuit, namely that the current moves from the positive boundary-mark to the negative boundary-mark. Since the bulb is joined to a positive boundary-mark and to the other negative, therefore the current circulates. It is about the unipolar model that ensues implicitly from the teaching, contrary to the unipolar model that ensues from first intuition, according to which the current circulates from the battery toward the bulb, as underlined in the introduction. As an illustration, the justifications advanced by the students are:

“It will normally shine because it is plugged in to the positive and negative terminals.” (e47)

“Indeed, I believe that a lamp can be plugged in to 2 batteries as far as the current flows from (+) of one battery towards the (-) of the other.” (e21)

“The electric current should flow between the positive and the negative.” (e65)

“If the wire is in contact with the two positive boundary-marks, it would have flown in the circuit.” (e66)

This question has been asked to students of the secondary school in the setting of a research carrying on the transition between electrokinetics and electrostatics of which several, to justify the lighting of the bulb, referred to the law of attraction between the electric charges of opposite signs (Bensghir and Closset, 1996).

Analysis of question #5

One observes a weak reduction of students having advanced a correct answer, namely that the circuit 2 is open compared to the circuit of the question 4 (31%) that is similar, but where one had modified the formulation of the question. Thus, for this question, 31% refer to the bipolar model to justify their answer:

“Bulb A will light, whereas bulb B will be extinguished because the current does not flow beyond the positive terminal of the second battery.” (e1)

“So that the bulb lights, the energy must come out of (+) and (-) terminals of the same battery, otherwise the bulb won't light because there will no energy dissipation.” (e8)

“Only bulb A will light because the circuit is closed. While there is no current in the other circuit because it is open circuit.” (e48)

“In circuit 2, bulb B won't shine. Because both batteries should be connected.” (e52)

For the students according to whom the B bulb will work (69%), the justifications given allowed us to identify two erroneous conceptions presented below with the percentages of each, followed by the presentation of some answers as an illustration:

Conception 1 (40/88 - 45%): Bulbs A and B will light similar because (1) identical currents will pass through the bulbs, (2) the batteries have equal voltage (1.5 v), (3) the currents passes through the (+) and the (-) terminals of two identical batteries (each of 1,5 V), (4) the places where start the currents (the pole +) belong to identical batteries (1, 5 V), etc. (Unipolar model).

“The B bulb shines as the bulb A, because it leaves nevertheless of the positive in 1,5 V and it arrives to the negative in 1,5 V.” (e9)

“Considering that the two batteries are identical, I think bulbs A and B will shine similar.” (e11)

“Bulbs A and B should shine the same way since they each one has a positive and negative terminals.” (e12)

“I don't believe that it has a tie. The important it is that the 2 leave from the (+) to the (-). They will shine with the same intensity.” (e21)

“The current that flows from the battery to the bulb is the same (1,5 V) the bulbs will shine with the same intensity. The two batteries of circuit 2 don't combine themselves.” (e24)

“I think they receive the same amount of voltage. I don't think if they are connected in this way, the voltage will multiply.” (e47)

Conception 2 (21/88 - 24%): Bulb B will light more than bulb A because it (1) receives more current (two batteries), (2) more voltage (3 V) therefore more of current, (3) more energy or (4) the wires shorter.

“It is true, because bulb B will receive more energy than bulb A. Bulb B has two batteries while bulb A has only one.” (e3)

“Bulb B will shine more strongly, since it is connected to 3 V rather than 1,5 V.” (e26)

“Bulb B will light more, because the connecting wire between the 2 batteries is shorter than the first circuit.” (e65)

“In circuit 1, there is only a + to provide the current. In the circuit 2, there are 2 + to provide the current, therefore this circuit offers more electric current.” (e70)

“The current is the same, but the charges stored are different. B won't shine more than A; it will shine longer.” (e74)

“If the two bulbs are identical, lit once, they will remain identical. Only the bulb B will light more.” (e81)

“The source of the batteries is the same, which is 1.5 V. Circuit 2 will take more time to release the charges. This is the only difference.” (e86)

6. Summary of the results

A very small percentage of students answered correctly, based on coherent reasoning. Others have provided incorrect answers. A comparison between the conceptions identified and those developed in the context of circuit theory is presented in Table 1.

Table 1. Summary of students' conceptions and of their corresponding scientifically accepted counterpart.

<i>Students' conception</i>	<i>Scientific conception</i>
When one makes a switch on position “On” to light a bulb whose filament is broken, the electric current passes until the bulb.	No current circulates in a branch containing a bulb whose filament is broken, because this last opens the branch.
A break anywhere in the path don't mean that the electric current stops passing. For exemple, if the filament of the lamp break, the current pass through the lamp even though it won't light.	A break anywhere in the path results in an open circuit, and the flow of electrons ceases.
A bulb connected between the positive terminal of a battery (1,5-V) and the negative terminal of another battery (1,5-V) has the same light intensity that if it was plugged between the two poles of a battery (1,5-V) since, in the two cases, we have a current that circulate from the positive terminal toward the negative terminal.	A bulb connected between the positive terminal of a battery (1,5-V) and the negative terminal of another battery (1,5-V) is not moved by any flow of electrons since the circuit is open.
A bulb connected between the positive terminal of a battery (1,5-V) and the negative terminal of another battery (1,5-V) receives two times more current than if it was connected to the positive terminal and negative terminal of a battery 1,5-V.	
If two bulbs are connected in series with a battery and that one of the two bulbs illuminate and the other no, then the one that doesn't illuminate is burnt.	The bulb that doesn't function cannot be burnt, otherwise the circuit would be open. If the two bulbs were plugged in parallel, it can happen that the one that doesn't function is burnt.
If two bulbs are connected in series with a battery and that one of the two bulbs illuminates and the other no, then the one that illuminate received the whole current of the battery and it didn't remain any anymore for the one that doesn't illuminate.	If two bulbs are connected in series with a battery, the current is the same through the bulbs in the circuit. If the two bulbs they don't have the same brightness it means that the two bulbs don't have the same characteristics (are not identical).

7. Conclusion

The results of this research demonstrate the necessity to conceive non canonical situation-problems to identify the alternative conceptions of the students in order to verify if they indeed have understood the basic notions associated to the field of the electric circuits. To attain this objective, it would be necessary to interrogate them on several related situations, as presented in this research, in the case of the notions of open and closed circuits. The results of the researches achieved throughout the world prove the recourse to the unipolar model by children to interpret the working of a simple circuit composed of a battery, a bulb and two connecting wires is very early abandoned and they rather refer to other erroneous models more evolved (clashing currents, attenuating and sharing in a series circuit). However, while interrogating the students on the working of more complex circuits, we showed that they refer simultaneously to the unipolar model and non-unipolar model. This last result can be explained by the complex phenomenon of the juxtaposition in learner's conceptual structure of several contradictory explanatory systems with respect to the same phenomenon, dependently of the context one gives to it (Mackay and Hobden, 2012; Métioui and Trudel, 2012):

“In the same way, the overlap between context and cognitive factors in conceptual situations such as the wiring of a dolls house is a fertile avenue for further research. Whether or not the transitional thinking found in developing wiring diagrams from circuit diagrams is evidence of the influence of context and the failure of students to transfer conceptual knowledge from one context to another or of the development of intermediate concepts within a conceptual development process needs further investigation, as does the high prevalence of unipolar thinking amongst students.” (Mackay and Hobden, 2012, page 142)

To help students to give up the unipolar model, a didactic intervention would be necessary, one that would be able to produce conceptual conflicts while putting them in situations in which this model will be proved to be inadequate (Vosniadou, Vamvakoussi and Skopeliti, 2008; Treagust, 2006; Posner, Strike, Hewson and Gertzog, 1982). The situations presented to the students should take into account their alternative conceptions, as identified in this research and others done in the same perspective.

References

- Arons, A. (1981). Thinking, reasoning and understanding in introductory physics courses. *The physics Teacher*, 3, 166-172.
- Canãl, P. (1999). Photosynthesis and “inverse respiration” in plants: an inevitable misconception? *International Journal of Science Education* 21(4), 363-371.
- Benseghir, A. and Closset, J.-L. (1996). The electrostatic-electrocinetics transition: historical and educational difficulties. *The International Journal of Science Education*, 18(2), 179-191.
- Closset, J.-L. (1983). Le raisonnement séquentiel en électronique (The Sequential reasoning in Electronic). Thèse de troisième cycle, Université Paris 7, Paris.
- Furió, C., Guisasola, J. and Almudi, J.-M. (2004). Elementary Electrostatic Phenomena: Historical Hindrances and Students’ Difficulties. *Canadian Journal of Science, Mathematics and Education*, 4(3), 291-313.
- Fredette, N. and Lochhead, J. (1980). Student conceptions of simple circuits, *The Physics Teacher*, 18(3), 194-198.
- Henriques, L. (2002). Children’s ideas about weather. A review of the literature, *School Science and Mathematics*, 102(5), 202-215.
- Gilbert, J. K. and Watts, D. M. (1983). Concepts, misconceptions and alternative conceptions: changing perspectives in science education. *Studies in Science Education*, 10, 61-98.
- Jabot, M. and Henry, D. (2007). Mental Models of Elementary and Middle School Students in Analyzing Simple Battery and Bulb Circuits, *School Science and Mathematics*, 107(1), 371-381.
- Mackay, J. and Hobden, P. (2012). Using circuit and wiring diagrams to identify students’ preconceived ideas about basic electric circuits. *African Journal of Research in MST Education*, 16(2), 131-144.
- Métioui, A. and Baulu MacWillie, M. (2015). Pupil's beliefs about the Transformations of Energy in three Countries (Canada, France and Morocco). *Universal Journal of Educational Research*, 3(2), 75-84.
- Métioui, A. and Baulu MacWillie, M. (2013). Children's Beliefs about the Concepts of Distance, Time and Speed, *International Journal of Education, Learning and Development*, 1(2), 24-38.
- Métioui, A. and Trudel, L. (2012). The model of the rectilinear propagation of light and the study of the variation of the size of a shadow. *US-China Education Review*, 2(9), p. 173-186.
- Métioui, A. and Trudel, L. (2012). Acquiring Knowledge in Learning Concepts from Electrical Circuits: The Use of Multiple Representations in Technology-Based Learning Environments. *Journal of Systemics, Cybernetics and Informatics*, 10(2), p. 24-35.
- McDermott L.C. and Shaffer P.S. (1992). Research as a guide for curriculum development: An example from introductory electricity. Part 1: Investigation of student understanding. *American Journal of Physics*, 60(11), 994-1013.
- Pilatou, V. and Stavridou, H. (2004). How primary school students understand mains electricity and its distribution, *International Journal of Science Education*, 6, 697-715.
- Posner, G.J., Strike, K.A., Hewson, P.W. and Gertzog, W.A. (1982). Accommodation of scientific conception: Toward theory of conceptual change. *Science Education*, 66(2), 211-227.

- Sharp, J.G. (1996). Children's astronomical beliefs: A preliminary study of year 6 children in south-west England, *International Journal of Science Education*, 18(6), 685-712.
- Stanton, M. (1990). Students' alternative Conceptions of the DC circuit-3. *Spectrum*, 28(4), 32-38.
- Shipstone, D. (1988). Pupils' understanding of simple electrical circuits. *Physics Education*, 23, 92-96.
- Tasker, R. and Osborne, R. (1985). Science teaching and science learning. In R. Osborne & P. Freyberg (eds.), *Learning in science: The implications of children's science*. (pp. 15-27). Auckland: Heinemann.
- Tiberghien, A. (1983). Critical review of research concerning the meaning of electric circuits for students aged 8 to 20 years. In Research on Physics Education, Proceedings of the First International Workshop, La Londe les Maures, France, Editions du Centre National de la Recherche Scientifique, Paris (1984), 109-123.
- Treagust, D.F. (2006). Conceptual change as a viable approach to understanding student learning in science. In K.G. Tobin (Ed.) *Teaching and Learning Science, A Handbook*. (pp. 25-32) Westport, Connecticut: Praeger.
- Valanides, N. (2000). Primary student teachers' understanding of the particulate nature of matter and its transformations during dissolving, *Chemistry Education: Research and practice in Europe*, 1(2), 249-262.
- Webb, P. (1992). Primary science teachers' understandings of electric current, *International Journal of Science Education*, 14(4), 423-429.
- Vosniadou, S., Vamvakoussi, X., & Skopeliti, I. (2008). The framework theory approach to the problem of conceptual change, In Vosniadou (ed.) *International handbook of research on conceptual change*. (pp. 3-34). New York: Routledge

ANNEX

Questionnaire on electrical circuit

Question 1:

In the circuit shown, the switch is "On", but the filament of the lamp is burned. There is electric current flowing through the wires leading to the lamp.

True False

Justify your choice :

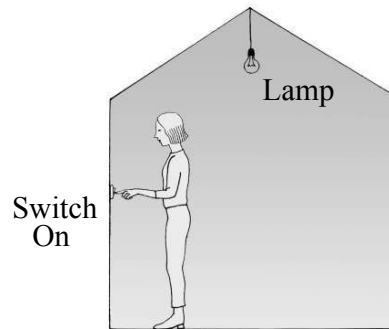

Question 2:

In the circuit shown one observes that bulb A lights normally whereas bulb B doesn't. This tells that bulb B is burned.

True False

Justify your choice :

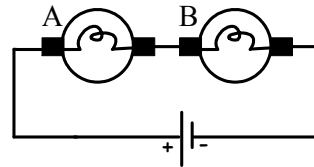

Question 3:

In the circuit shown, if bulbs A, B and C are identical, they will shine with the same brightness.

True False

Justify your choice :

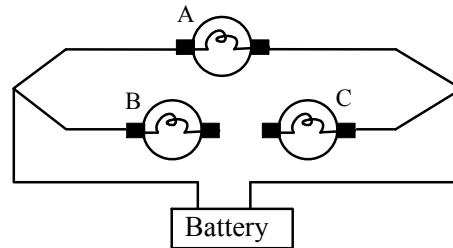

Question 4:

In the circuit shown, the lamp will light normally since the electric current flows across its pole + and pole - terminals.

True False

Justify your choice :

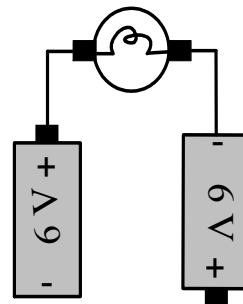

Question 5:

In circuits 1 and 2, if bulbs A and B are identical, bulb B must shine two times as much as bulb A because it is connected to the (+) and (-) terminals of the batteries, each of 1.5V.

True False

Justify your choice :

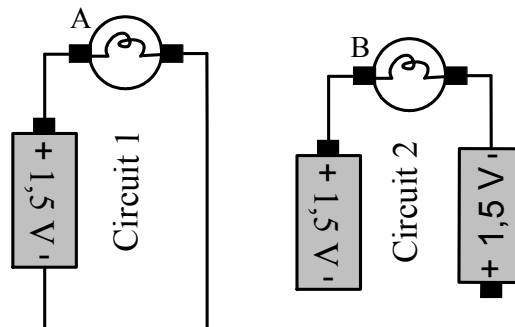

The Role of Scientific Museums in Physics Education Courses for Pre-Service Primary School Teachers

Ornella Pantano¹, Sofia Talas², Valeria Zanini³

¹ *Department of Physics and Astronomy, University of Padova, Italy*

² *Museum of the History of Physics, University of Padova, Italy*

³ *INAF – Astronomical Observatory of Padova, Italy*

Abstract

Within the 2013-14 Physics Education Course for pre-service primary school teachers, we have developed an educational project involving the Museum of the History of Physics of Padua University and the Museum of Astronomy of Padua Astronomical Observatory. The main goals of the project were: (a) to stimulate in pre-service teachers a reflection on how scientific museums could be used for proposing effective and motivating scientific experiences within primary school curricula, (b) make them experience and recognize the advantages of an historical and narrative approach in the learning of a new subject. The presentations in the Museums focused on the relation between instruments and the evolution of scientific knowledge. Cosmological models from the ancient times up to eighteenth century were presented through instruments, paintings and significant narratives related to astronomers and physicists of the past. The effectiveness of the experience was evaluated through a written essay that students were asked to write at the end of both visits.

Keywords

Pre-service teacher education, astronomy education, museums.

1. Introduction and context of the project

In Padua, the physics education course for pre-service primary school teachers is organized so that most of the physics concepts are introduced through practical experiences. The course includes 60 hours of classroom lectures and 16 hours of laboratory activities. About 180 students attend the course every year and during the laboratory activities they are subdivided in groups of 30 people. The classroom lectures present and discuss basic physics concepts, together with an illustration of possible school activities that future teachers could organize at school to develop scientific knowledge and attitude in children, from kindergarten to the end of primary school.

Every year a particular topic is selected and several activities, including the laboratory on physics education, are dedicated to a deeper analysis of this special topic. The idea is to illustrate through a particular example how each topic needs to be explored at various levels along the whole school period. Particular emphasis is put on everyday experiences of the phenomena under study and on interdisciplinary connections, in order to help future school teachers to develop scientific educational projects meaningful for young students.

From 2014, the course was reorganised according to the National Indications of the reformed university curriculum for the graduation of primary school teachers. One of the main changes introduced by the new Indications was the requirement to include some basic astronomical topics in the physics education course. For this reason, in the academic year 2013-14, the special topic of the course was “Astronomy”, which was explored through various activities in classroom and outdoors, in laboratory and at museums.

In the classroom, one of the activities was the construction of a quadrant with cardboard, string and a small weight; this activity was done in collaboration with the teacher of mathematics education. The quadrant is an instrument used to measure angles up to 90° : it can be used for measuring the position of sky objects, like stars, the Sun and the Moon, but it can also be used for measuring the height of buildings. It is worth mentioning that quadrants were widely used in Europe during the Renaissance and the sixteenth century in astronomy, time measuring and surveying. In figure 1, we see students outdoors learning how to use a quadrant for measuring the height of a building.



Figure 1. Outdoors activities: learning how to use a quadrant.

In the laboratory, students first explored the properties of light, in particular the characteristics of the shadow produced on a screen behind an object in relation with the position and extension of the light source. These experiences helped them to construct the straight-lines model of light, useful for interpreting astronomical observations, like day and night alternation. The straight-lines model was then used for interpreting reflection and refraction phenomena. The second part of the laboratory was dedicated to the analysis of astronomical phenomena, like the length of day and night at different latitudes, the characteristics of lunar phases in relation to the Earth, Moon and Sun's relative positions. For these explorations students used light sources and spheres as physical models for representing the Earth and the Moon (see figure 2).



Figure 2. Modeling the Earth-Moon-Sun astronomical system.

Finally, in tight connection with the activities just mentioned, a project was developed in order to plan and organize specific visits and activities at the Museum of the History of Physics of Padua University and at the Museum *La Specola* of Padua Astronomical Observatory. The project was the fruit of the collaboration of the three authors of the present paper, Ornella Pantano, who is in charge of the Physics Education course, Sofia Talas, the Curator of the Museum of History of Physics, and Valeria Zanini, the Curator of the Museum *La Specola*.

The advantages of a historical approach in the learning of a specific subject is well documented in the literature [see e.g., Monk & Osborne, 1997; Rudge & Howe, 2009], but the actual state of implementation of this approach in schools is still poor due to the difficulty of finding and adapting history-based teaching material and the lack of pedagogical content knowledge necessary for confident and effective teaching [Henke & Höttecke, 2014]. We think that one of the ways to deal with these problems could consist in

exposing future teachers to a personal experience of learning paths in historical scientific museums. Two of the authors have a wide experience in developing thematic paths in physics for secondary school students with laboratory activities and visits to the Museum of the History of Physics [Pantano & Talas, 2010]. This was the first experience with undergraduate students doing a primary school teacher degree.

After an outline of the two Museums involved in the project, the paper will describe the main goals of the project, its content and some final considerations on its outcomes.

2. The two Museums involved, a short presentation

Both the Museum of the History of Physics and *La Specola* keep important collections of physics and astronomical instruments, heritage of the fruitful scientific activity at Padua University throughout the centuries. Historical instruments, working places and paintings constitute windows to examine and understand the way cosmological models evolved throughout the centuries.

The Museum of the History of Physics houses the instruments that were invented, made or used at the University of Padua to carry out physics research and teaching [Talas, 2012; Talas, 2013]. A first nucleus of instruments was collected for the lecture courses on Experimental Philosophy – Experimental Physics in modern terms - that were introduced at the University of Padua in 1738. Giovanni Poleni, who was assigned the new chair, gathered a first group of machines within a couple of years and he continued to enrich the collection until his death, in 1761. His successors went on acquiring new instruments both for teaching and research, including objects that already had an historical value. The Museum thus has some sixteenth- and seventeenth-century devices, but the main part of its collection is made of instruments of the eighteenth, nineteenth and twentieth century.

The other museum involved in the project was *La Specola*, which preserves the instruments and historical heritage of the Astronomical Observatory of Padua, one of the main structures of the National Institute of Astrophysics (INAF) [Pigatto, 2007]. The Astronomical Observatory of Padua was founded in 1761, within a complex program of reform that the University of Padua developed in order to instruct the students in the practice of experimentation. The high tower of the old city castle was chosen as the best place where to build the Observatory, which was made of two parts: a lower observatory, flanking the east wall of the tower at a height of 16 meters from the ground, and a higher one, at 35 meters, on the battlements. The lower observatory was later called the Meridian Room. Here, the local time at midday was measured along the meridian line carved in the floor, and stars were observed in their transit across the celestial meridian. The upper observatory was dedicated to observations with telescopes of various types, which could be pointed in different directions and also moved outside, on the terrace surrounding the tower. The museum collection includes telescopes, globes and quadrants of the eighteenth and nineteenth century. All the instruments are placed in the rooms where the astronomers used to work in the past.

3. The main goals of the Museums Educational Project

The project has been developed within a course in which prospective primary school teachers learn both some basic physics and astronomy topics and how to teach those subjects to young children. For this reason the goals of the project concerned both the discipline and its teaching.

From the point of view of the discipline, the aims of the project were to present to the students the principal steps in the evolution of cosmological models across centuries and, at the same time, outline some important features of scientific methodology. Cosmological models from the ancient times up to the eighteenth century were presented using instruments, paintings and narratives related to astronomers and physicists of the past. The important features of scientific methodology were discussed through the storytelling of some of the events that led to the development of new models and theories. The description of some historical instruments and the story of their role in scientific discoveries was very effective in showing the relationship between instruments and the evolution of scientific knowledge. This relation between the advance of technology and the growth of scientific knowledge is a theme very important also today.

From the point of view of physics and astronomy education, the main goals of the project were (a) to stimulate in pre-service teachers a reflection on how scientific museums could be used for scientific education in primary schools and (b) make future teachers experience and recognize the advantages of a historical and narrative approach in learning a new scientific subject. In order to attain those goals, we exposed pre-service teachers to the same kind of experience that they could propose in the future to their students.

4. The Museums Educational Project

The Museum Educational Project proposed to the students one visit of about 1,5 hour at each Museum. The students could participate on a voluntary basis but, as the Physics Education Course is attended by around 180 students and as there were many requests for participation, it was decided that groups of 30 students would be created. These groups were then divided in two sub-groups of 15 people, so to facilitate the interaction between the students and the Museums' staff. The idea was to start from the objects and from the buildings, in order to extract from them information and details.

In tight connection with the topics treated at the Physics Education Course, the visit at the Museum of the History of Physics focused on two groups of instruments: a couple of astronomical Renaissance instruments – an astrolabe and an armillary sphere -, and the optical instruments of the Museum, with a particular focus on telescopes and microscopes.

We started from the observation of the astrolabe and the armillary sphere and, at first, we discussed the stories of the people around these objects. Who made them? Who used them, and so on? The astrolabe for instance, is signed “Renerus Arsenius Nepos Gemme Frisy Faciebat Louany 1566” and it is worth reminding that Arsenius worked in Louvain with Gemma Frisius, mathematician, cartographer and inventor of scientific instruments (figure 3).



Figure 3. Astrolabe by Renerus Arsenius, Museum of the History of Physics, University of Padua

We examined the way these instruments were used and, as for the astrolabe, this was made easier because the students had already made and used a quadrant during the Physics Education Course. But there is much more information lying within these objects. They tell about the theories and models of their time, in this case about the Ptolemaic-Aristotelean model of the universe, with the Earth unmoving and located at the center of the Universe. They also tell about the role of scientific instruments in the Renaissance. At that time, mathematics was applied not only to transform the art of painting through the introduction of perspective, but it was also applied to the needs of the other arts through the invention or the improvement of instruments. Gnomonic, astronomy, the art of topography, the art of navigation and the military art were thus transformed by the so-called “practical mathematics”. Several Renaissance engravings, showing the use of astrolabes and other instruments for surveying or even military uses, were presented to the students in this sense. However, it was also crucial to underline to the students that these instruments, used as models and/or for measurements and calculations, were not regarded at that time as possible conveyers of new knowledge about Nature. The latter was only the matter of philosophers and it was based on Ancient texts. Observations and measurements could not significantly change the accepted models of the World.

Renaissance instruments nevertheless started to be regarded as symbols of power, as they were crucial for navigation and surveying of the newly discovered countries. It is not by chance that Manoel I of Portugal included in his flag an armillary sphere at the end of the fifteenth century, and that armillary spheres became part of the Manueline architectural style. Instruments were also regarded as symbols of knowledge, and lots of them were included in paintings by Renaissance artists like Giorgione, Vittore Carpaccio, or Hans Holbein the Young. Scientific instruments became in those years symbols of social status as well, so that astrolabes, armillary spheres and quadrants were included as part of the Wunderkammer, the Renaissance noble collections. In this sense, instruments thus also tell us about the connections between science and the society of their time.

The second part of the visit to the Museum of the History of Physics then dealt with telescopes, microscopes and other optical instruments. Here again, details were given about the single instruments, their inventors, makers and users. However, as in the case of the astrolabe and armillary sphere, there is much more

information to be extracted from telescopes and microscopes. They are among the main instruments that marked the Scientific Revolution. Telescopes, in particular, were crucial to observe the sky and look for confirmations of the Copernican Model, the newly proposed model of the Universe, in which the Earth and other celestial bodies move around the Sun. Moreover, they marked the introduction of a totally new way of studying Nature. Galileo refused to base himself on the authority of the Ancient scholars and on what he called a “*mondo di carta*”. He wanted to read “the book of Nature” and used instruments to do so. Instruments thus became the essential media between Man and Nature: this was a totally new role for instruments, which became crucial for scientific research, thus marking the birth of the so-called Scientific Method. Moreover, a new link between Science and Technology was established, a link which is still one of the main features of Modern Science.

At the Museum *La Specola* the aim of the visit was not only to see the ancient instruments, but also to observe the whole building, which represents itself a scientific instrument.

The visit began with the video “Ancient Heavens”, which illustrated the special relationship that humanity always had with the sky. Since ancient times, in fact, an eternal and perfect order was felt in the great sky, conflicting with the transience of everyday life. A geocentric picture of the Cosmos consolidated in the Greek era and survived until the mid-sixteenth century, when the Polish astronomer Nicolaus Copernicus proposed his new model of the Universe. The video thus reminded the evolution of cosmological models, already discussed at the Museum of the History of Physics. It also emphasized the crucial role of the *habit to observe* the sky, which was typical of ancient men, an habit which is today very rare not only in students, but in teachers as well.

The visit continued in the Meridian Room and focused especially on the meridian line and the mural quadrant. The meridian line was carved in 1776 and, on this line, the true midday of Padua Observatory was measured by the Sun’s luminous image projected on the floor through the gnomonic hole placed in the south wall of the room. This was the first important device used by astronomers to measure the time and to set clocks; but we also showed to the students its usefulness today for understanding the movement of the Sun on the celestial sphere throughout the year. The students’ attention was then focused on the mural quadrant, made by the famous instrument-maker Jesse Ramsden and installed in the Meridian Room in 1779. The mural quadrant was used to measure the height of stars above the horizon at their transit at the celestial meridian. It was an extremely precise instrument for that epoch and students were explained that, in order to ensure the maximum exactness in hand-made graduations and avoid errors in divisions, mural quadrants were built very large: in this case the quadrant radius is 244 cm. Future teachers could thus appreciate the close link between scientific knowledge (mathematics and astronomy in particular) and the technical skills of manufacturers.

Reinforcing what had been shown at the Museum of the History of Physics, the Meridian Room provided the students with another practical example on how the Scientific Revolution implemented the new methodology of knowledge both through observation and experimentation, and through the central role of instruments.



Figure 4. The fresco in the Meridian Room showing the Solar system before 1781, Museum *La Specola*.

Highly instructive was also the large fresco painted on the east wall of the Meridian Room (figure 4). This fresco shows with considerable accuracy the geometrical configuration of the model of the solar system before 1781 and it was for students an efficient visual summary of the astronomical knowledge at the end of the XVIII century.

The visit ended in the Figures Room (figure 5), where eight life-size full-length portraits of famous personages in the field of astronomy are painted all around the walls. They are, in chronological order: Ptolemy, Nicolaus Copernicus, Tycho Brahe, Galileo Galilei, Johann Kepler, Isaac Newton, Geminiano Montanari and Giovanni Poleni. The students were told about the scientific activity of these personalities, whose contribution to the development of scientific knowledge and the evolution of cosmological models was fundamental.



Figure 5. Students looking at pictures and listening narratives related to important astronomers of the past in the Figures Room, Museum *La Specola*.

5. Assessment and conclusions

The impact and effectiveness of the experience have been evaluated through a questionnaire that students answered at the end of each visit. The questionnaire was built in order to analyse, first, which part of the learning situation surprised them and arose the greatest interest towards the discipline and the particular subjects treated in the visits. Second, the questions also aimed at stimulating a reflection on how they could use the same context for inspiring in young children an interest toward physics and astronomy. These questions indirectly gave us a hint of the activity that was more inspiring for the future teachers themselves. The principal questions proposed were:

- What attracted you most and what would you like to know more about?
- What surprised you?
- What theme would you choose to deepen with the children?

An analysis of the answers has shown that many aspects of the project stimulated students' interest. They all were very impressed by the amount of information that a single instrument can infer and also by the beauty and perfection of ancient apparatus. In the following, we give some examples of particularly significant answers.

At the Museum of History of Physics:

What attracted you most and what would you like to know more about ?

- *“I found very interesting the part in which we have been explained about the scientific instruments used by the ancients (astrolabe). To see instruments is always very useful for understanding.”*
- *“There were many interesting objects, but the attention has been particularly attracted by the objects that we have reproduced during the lectures, as the octant which is similar to the instruments [quadrant] which we have constructed for measuring distances.”*

What surprised you?

- *“I was fascinated by the number of stories that a single instrument could evoke. Certainly children could absolutely be involved by the history of objects and the history of physics.”*

What theme would you choose to deepen with the children?

- “I would choose optics [...]: I think that, with an appropriate presentation, it can be proposed at any age as it is amazing also for grown-up people.”

At the Museum of Astronomy:

What attracted you most and what would you like to know more about ?

- “I was intrigued by the Meridian Room and I wonder with which instruments they built the line of meridian, how they decided where to put the hole in the wall in such a way that the sun could reflect [sic] exactly on that line.”

What surprised you?

- “I was very impressed by the fresco in Meridian Room, which represented the Universe known until about the 17th century. I was impressed by the precision with which it has been done.”

What theme would you choose to deepen with the children?

- “With children I would deepen the Figures Room, using the magnificent frescos to narrate the history of astronomy, as pictures are a very good tool to use for presenting a new subject.”

The analysis of the answers showed what were the aspects of the presentation which most impressed future teachers and we could see that both of the goals behind our project were reached.

Students were impressed by the stories on the role of instruments and technology in the development of scientific knowledge and so, implicitly, they showed to appreciate the use of scientific museums and historical instruments for presenting scientific issues. In order to check the effective impact of this kind of experience, it would be worth planning an investigation to examine whether teachers who had experience of science museums in their education, more frequently include visits to scientific museums in their science teaching activities.

The students also recognized the advantages of an historical and narrative approach, as they outlined this aspect in most of the answers. Many of them also said they would choose this approach for their future teaching of astronomical issues. One could also plan an investigation on this point, to ascertain whether teachers who experienced an historical and narrative approach in their science education, would really use it in their science teaching.

References

- Henke, H., & Höttecke, D. (2014). Physics Teachers' Challenges in using History and Philosophy of Science in Teaching, *Science & Education*, <http://link.springer.com/article/10.1007/s11191-014-9737-3>, accessed 5 March 2015.
- Monk, M., & Osborne, J. (1997). Placing the history and philosophy of science on the curriculum: a model for the development of pedagogy, *Science Education* **81**, 405–24.
- Pantano, O., & Talas, S. (2010). Physics thematic path: laboratorial activities and historical scientific instruments, *Physics Education* **45**, 410-416.
- Pigatto, L. (2007). *La Specola di Padova. Da torre medievale a museo*, Signum, Padova, I.
- Rudge, D. W., & Howe, E. M. (2009). An explicit and reflective approach to the use of history to promote understanding of the nature of science, *Science & Education* **18**, 561–80.
- Talas S. (2012). Dall'astrolabio alle camere a bolle: Gli strumenti del Museo di Storia della Fisica di Padova, *Il Giornale di Fisica* **1**, 3-33.
- Talas S. (2013). New Light on the Cabinet of Physics of Padua. In Bennett J., & Talas S. (Eds), *Cabinets of Experimental Philosophy in Eighteenth-Century Europe* (pp. 49-67). Leiden-Boston: Brill.

Affiliation and address information

Ornella Pantano

Department of Physics and Astronomy
University of Padua
Via Marzolo 8
35131 Padova, Italy
e-mail: ornella.pantano@unipd.it

The Education of Pre-Service Primary School Teachers for Teaching Physics as Part of the Science Curriculum in Slovenia

Jerneja Pavlin, Mojca Čepič

University of Ljubljana, Faculty of Education

Abstract

The curriculum of primary education in Slovenia includes a substantial part of science topics, which are being taught already in the nursery school. Therefore, teaching science in primary schools is very important. The primary school teachers in Slovenia are required to finish a 5-year study programme at the Faculty of Education. In the course of study, they take some science classes (separate subjects: physics, chemistry and biology) intertwining with a didactics of science. The science subjects are considered difficult by the Slovenian pre-service primary teachers. The science curricula for pupils of age 6–10 in Slovenia prescribe that pupils should assimilate the following physics concepts: heat, temperature, density, viscosity, electricity, shadows, weather, movement of liquids, and several other concepts. It is evident that in order to teach the gifted knowledge-seeking pupils and weak pupils, a primary school teacher should obtain substantial knowledge in physics. The article focuses on the teaching module related to the concepts of heat and temperature for the pre-service primary teachers and its evaluation. The results of the pilot pre-post study without a control group performed in spring 2014 demonstrated the impact of the teaching module and confirmed the findings of several authors regarding the difficulties in understanding the content delivered in the module. The results also suggested guidelines for further research.

Keywords

Primary school teaching, heat and temperature, experiments, conceptual understanding

1. The education of Slovenian primary school teachers

A child is enrolled in a compulsory primary school at age of 6 in Slovenia. The compulsory primary school has 9 grades (Figure 1), which correspond to the primary level (grades 1–5) and lower secondary level (grades 6–9) in other countries. The Council of Experts for General Education in Slovenia approves the national curricula and determines the subjects and syllabuses. The teaching methods and textbooks are freely chosen by the teachers. After they finish primary school, the students enter vocational secondary schools, specialized technical schools or high schools. A high school in Slovenia is called *gimnazija* (Eng. gymnasium), which is similar to countries influenced by the German and Russian education system. The secondary school students gain their qualification after they pass the final exam successfully: the master craftsmen examination, the vocational matura (an English equivalent would be the A-level exams), or the general matura exam. The students who pass the general matura are eligible to enter higher education programs. There are four universities in Slovenia. The higher education in Slovenia comprises three levels. The first level includes higher professional programs (polytechnics) and academic (university) programs, the second level includes master's programs, and the third level includes doctoral programs.

The teachers in Slovenia generally finish a 5-year study program. The Slovenian primary school teachers finish the program called *Primary school teaching* at Faculty of Education. The primary school teachers in Slovenia can teach all subjects from the 1st to the 5th grade in primary school. The knowledge spectrum of the primary school teachers is considered wide, because it covers Slovenian, mathematics, natural and social sciences, music, physical education, arts, home economics, and English. On some occasions, schools may decide that sports, arts, music, and English are taught by teachers who are specialists in these subjects.

The pupils' first encounter with science, i.e. physics, is in the course of two subjects: Environmental Studies (grade 1–3) and Science and Technology (grade 4–5). The quality of teaching depends on the teachers that are required to possess good understanding of scientific concepts and the didactics of science. They have to be skilled in experimental work appropriate for younger students. Thus, the lecturer is responsible to ensure the adequate level of skills.

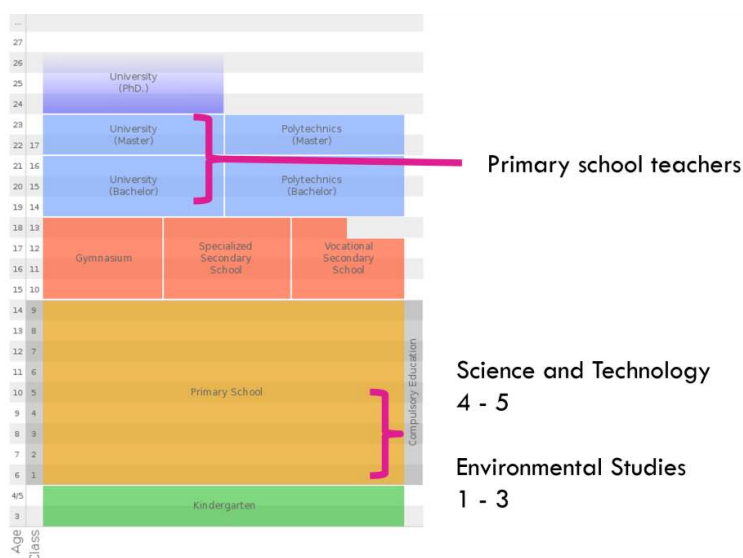

Figure 1. The education system in Slovenia. The primary school teachers in Slovenia finish 5 years study programme at the Faculty of Education. They are eligible to teach in primary schools from the 1st to the 5th grade. The physics contents are included in the subjects Environmental Studies and Science and Technology (Edufile, 2014).

In the course of study, the pre-service primary school teachers in Slovenia take science classes (separate subjects: physics, chemistry, and biology) intertwining with the didactics of science. Each science subject has 30 hours of lectures, 21 hours of laboratory work, 5 hours of seminars and 4 hours of field work. The intertwined didactics of science includes 8 hours of lectures and 7 hours of laboratory exercises are planned for the physics part.

The Environmental Studies and Science and Technology curricula prescribe a lot of practical work and skills development. The aim of the physics classes in the Primary school teaching programme is to ensure that students are able to understand and apply knowledge to achieve the curricular goals in the first five years of primary school. The students should also understand the basic laws of physics and be able to develop and implement experimental and other activities. This suggests that the teachers need to demonstrate these competencies and develop them at practical experimental work in the course of study. The students require time to comprehend the physics concepts and their understanding of physics is enhanced by experimental experience. For this reason, we developed a set of simple hands-on experiments that support the basic physics concepts studied at the university level, which may also be adapted for future work in primary schools.

In physics classes, the students attending the Primary school teaching programme are acquainted with the following contents in line with the physics part of the syllabus for Environmental Studies subject and subject Science and Technology: scientific method, basic operational procedures, measurements, mechanics, liquids, sound, thermodynamics, electricity and magnetism, light and colours, astronomy, and weather. The topics are explained at a qualitative and semi-quantitative level. Several laboratory experiments are prepared for the following topics: basic operational procedures, measurements, heat and temperature, light, electricity and magnetism, and weather. This paper discusses the activities related to thermodynamics and their evaluation. The most common misconceptions are examined as well.

2. Understanding heat and temperature

Several studies reported that the concepts of heat and temperature are still considered difficult to understand at all levels of education (Carlton, 2000; Erickson, 1979; Jara-Guerrero et al., 1993; Jasien and Oberem, 2002; Nottis et al., 2009). Our practical experience confirms this finding as well.

Thomaz et al. (1995) summarize five common misconceptions related to heat and temperature: (i) heat is a kind of a substance stored in the objects and it can move; (ii) students are not able to differentiate between heat and temperature (temperature is considered a measure of heat); (iii) the confusion between temperature and the feeling of warmth for an object and students are not aware of the concept of thermal equilibrium; (iv) the application of heat to a body always results in a rise in temperature, and (v) the temperature of a phase transition is the highest temperature of the substance when it is heated.

Albert (1978) reports that eight-year pupils describe heat as something dynamical that flows. The concept of treating heat as a flux between bodies appears at a later stage. The monograph entitled *The Kind of Motion We Call Heat Brush* (1986) presents misconceptions related to heat as a substance, something like air or stream, which could be added or removed from an object, similar to the caloric theory of heat held by scientists in 8th century. Most students are not able to differentiate between heat and temperature and they tend to use the terms heat and temperature as synonyms (Başer, 2006; Pathare and Pradham, 2005). This was also confirmed by the study of Prince and Vigeant (2006) suggesting that many undergraduate students of mechanical engineering treat heat and temperature as equivalent entities. While describing heat and temperature student descriptions contain phrases such as “Heat is the energy of a hot substance” and “Temperature is a measure of heat”. Furthermore, many of them describe temperature as a measure of how hot or cold an object feels (Carlton, 2000). A number of students believe that heating up an object always increases the temperature of the object (Yeo and Zadnik, 2001). At this point, the experiments involving phase transitions are to be conducted in order to raise awareness that the heating results in an increase of temperature or in phase transition. However, it is very difficult to rift many of the robust misconceptions during traditional lecturing approach (Nottis et al., 2009).

3. Teaching module related to the concepts of heat and temperature

Considering the curriculum for the physics part of science classes for pre-service primary school teachers in Slovenia and previously described misconceptions, a teaching module related to the concepts of heat and temperature was designed. The module includes 4 hours of lectures and 4 hours of experimental work in the course of laboratory exercises. The contents and activities of the module were carefully chosen. They also encompass the aims of the primary school curricula for Environmental Studies and Science and Technology (Kolar et al., 2011; Vodopivec et al., 2011). The aims are as follows: (i) primary school students describe the properties of substances before and after heating; (ii) they predict a change in the properties after heating and re-cooling of certain substances; (iii) they find out that metals conduct heat well; (iv) they know that heat flows from hot to cold objects; (v) they start to distinguish between heat and temperature: when a thermometer is heated, it receives heat, the liquid level in the thermometer rises until the thermal equilibrium is reached and the temperature of the thermometer is equal to the temperature of the substance; (vi) they measure the temperature; (vii) they use the thermometer; (viii) they learn that different substances conduct heat differently; and, (ix) they are familiar with the importance of thermal isolators (Kolar et al., 2011; Vodopivec et al., 2011). For this reason, the following contents are discussed and demonstrated with the experiments during the lectures for the pre-service primary school teachers in Slovenia: the meaning of terms hot and cold; temperature as a property; reasons for temperature changes, e.g. heating, cooling, and mechanical work; thermal conductivity; and phase transitions. During the laboratory exercises, the pre-service primary school teachers gain practical experimental experience they can relate to the concepts explained. They attempt to: a) measure the temperature of the water with fingers and thermometers; b) explore the necessary conditions required to measure the temperature; c) explore the operating principle of various thermometers; d) familiarise themselves with heat conductors and isolators as well as with heat flow; e) draw the graphs of the temperature as a function of time and read the data from them. The experiments covering the aims listed are shortly described below.

In the introductory experiment, the students explore the process of measuring the temperature by using their fingers (Figure 2). The aim of the experiment is to demonstrate why senses are not appropriate instruments for measuring temperature. Then the students carry out an experiment where they put their left forefinger in the glass with cold water and the right forefinger in the glass with hot water and wait for about 20–30 seconds. Afterwards, they simultaneously put both fingers in a glass with lukewarm water. They discuss the feelings (senses) and the results of the estimation of the temperature.

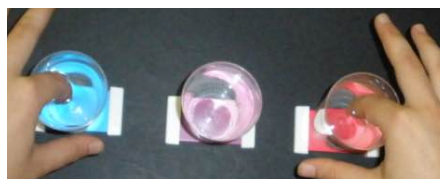

Figure 2. Measuring the temperature of hot (right), cold (left), and lukewarm (middle) water using fingers.

The following experiment is the next logical step in the laboratory exercises, because it leads the students to the knowledge about the thermometers and conditions required to measure the temperature. At this point, the students need to learn how to differentiate between heat and temperature. A thermometer relies on the variation of the thermometric property, e.g. length, colour, resistance (Figure 3). The variation of the property is monitored and the measurement of this property (length for instance) is related to the temperature. The students attempt to use different thermometers as well as describe and explain what happens while measuring the temperature using the laws of thermodynamics. They learn when and how to read the temperature from the thermometer and explore the conditions required to measure the temperature of an object.

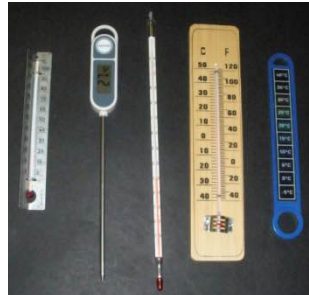

Figure 3. Various example thermometers: resistance, alcohol, and liquid crystal thermometers.

The approach of teaching the students that different substances conduct heat differently and helping them understand the importance of thermal isolators is covered in the activity related to the following experiment. In the experiment, the students are required to arrange plates of different materials from the coldest to the warmest (Figure 4). In this regard, we intentionally avoided using the term temperature. Then the temperature of the plates is discussed and, finally, it is measured by an IR thermometer. The students once again realize that senses are not reliable when measuring temperature. Finger sensors for temperature are relatively correct, but finger temperatures vary if the finger is in contact with a good cold thermal conductor compared to contact with an insulator. To illustrate that this phenomenon is related to thermal conductivity, ice cubes are placed on the plates and the melting process is observed and compared. At this point, the concepts of heat flow and thermal conductivity are discussed in detail.

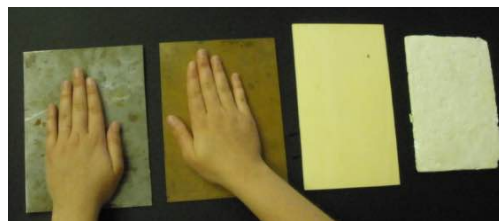

Figure 4. Arranging plates made of various materials from the coldest to the warmest.

The heat flow is directed from the object with a higher temperature to the object with a lower temperature. The temperature may change because of the heat transfer. The agreement about the direction of the heat flow and the differences between heat and temperature are discussed after performing the experiment shown in the Figure 5. The students insert a small can into a big can and fill the small can with hot water. Then they fill the big can with cold water. The measurements of both temperatures (for hot and cold water) begin immediately after the cans are filled. Students measure the temperature every 30 seconds in the period of 5 minutes. They draw both graphs of time dependence of temperature in warm and cold water on the same coordinate system. They discuss the data that can be read from the graphs.



Figure 5. Measuring the time dependence of the temperature in cans with hot and cold water.

In the final experiment, the students discuss the possibilities of reducing the heat flow (Figure 6). The objectives in the experiment include the aims of the experiments from the Figure 4 and Figure 5 and the objective to teach the students how to calculate the amount of heat transferred. The students take a polystyrene glass. The polystyrene glass is split into two halves by a barrier. The polystyrene glass is used to minimize the heat flow to the surroundings. Different barriers are available, for example, plastic as a thermal insulator and metal as a thermal conductor. Jars with hot and cold water are prepared in advance. The students measure the temperature of hot and cold water in the jars. They pour 1 dl of cold water in one half of the polystyrene glass and in the same amount of hot water in the other half. Then they measure the temperature of the water in both halves every half minute in the period of 5 minutes. The students repeat the experiment using a second glass with a different barrier. They present their measurements as graphs and calculate the amount of heat that has been transferred. In addition, the students illustrate the heat flows between parts of the glass and to the surroundings using arrows. The arrows indicate the direction of the heat flow and arrow thickness indicates the magnitude of the flow.



Figure 6. Measuring the time dependence of the temperature in both halves of a polystyrene glass with hot and cold water where the barrier is made of a conductor (left) and isolator (right). The experiment shows that the cold compartment absorbs approximately the same amount of heat that is released by the hot compartment.

4. Teaching module evaluation

The teaching module related to the concepts of heat and temperature for pre-service primary school teachers in Slovenia was tested in the course of the pre-service programme for primary school teachers in Slovenia. The aim of the pilot study assessing student prior knowledge and achievements was to answer the following questions: How and to what extent does the teaching module enable the students to comprehend the concepts of heat and temperature?

108 students (102 female and 6 male) in the first year of primary school teaching programme participated in the pilot pre-post study with no control group in spring 2014. The average age of the students was 20 years ($SD = 1$ year). On average, they achieved 20.0 points ($SD = 4.3$) out of 34 in the final exam at the end of gymnasium compared to the Slovenian average in the general matura exam that was also 20.0 points in school year 2012–13. Most students did not have any special preferences to physics. Only 4 % of the students chose physics as a subject of assessment in the general matura exam and 14 % of them described physics as interesting.

The module comprised 4 hours of lectures and 4 hours of experimental work in laboratory exercises. In comparison to the laboratory exercises, the lectures are not compulsory. 2 hours of each were performed per week. The students worked in pairs in the laboratory exercises.

The students showed little interest to cooperate in collecting data, thus only short paper-pencil questionnaires related to heat and temperature were applied (3 times). The questionnaires were applied for the first time

before the start of lectures in the beginning of April 2014, then immediately after the laboratory exercises (post-test 1) in the end of April 2014 and as a part of the exam in June 2014 (post-test 2). Some of the questions not present on all questionnaires are marked with a forward slash “/”. Field notes were taken as well.

5. Results and discussion

After the student answers were analysed, we divided the results obtained into 4 groups: heat, phase transitions, thermal equilibrium, and heat transfer.

The first task the students were required to perform was to describe the concept of heat. The most common student answers related to heat are presented in Table 1. In the pre-test, 40 % of students wrote that heat is a type of energy and 13 % of students wrote that heat tells us how hot or cold the object is. In the post-test 1, the percentage of students who related heat to hot and cold object was lower (5 %), while the percentage of students who wrote that the heat is a type of energy increased to 44 %. Heat is energy, which was transferred from an object with higher temperature to an object with lower temperature, wrote 29 % of the students in the post-test 1 compared to only 7 % in the pre-test.

The second set of tasks was related to the temperature of the phase transitions and graphs. The two tasks were very similar, because the students were required to draw a graph illustrating the time dependence of temperature for the experiment described. The experiments conducted were as follows: (i) a student puts a thermometer in 1 l of tap water in the bowl and heat it for an hour; (ii) the student puts the thermometer in bowl with a mixture of ice and water for one hour. The percentage of students who drew the graphs correctly for the experiment (ii) was higher in the pre-test compared to the post-test 1 (Table 2). In part, this may be attributed to the fact that students were not willing to fill in the questionnaires. However, the percentage of students who draw the graphs correctly in the exam was the highest (about 50 %). The most common mistakes were an unmarked axis and straight line drawn without realizing that phase transition appears at a certain temperature and it is determined by the substance. The straight line as a graph partly confirms the findings of Thomaz et al. (1995) that the application of heat to a body always results in a rise in temperature. These results correlate to Carlton’s study (2000) reporting that many students are unwilling to accept that solid ice, melting ice, and liquid water can all exist at the same well-defined temperature. The opposite task where students are required to read the melting point of the mixture seems easier for students, because 87 % of them read the information from the graph correctly.

Table 1. Percentage of students who described heat as: a) something related to how hot or cold objects are; b) as energy; and c) as energy that spontaneously flows from a higher temperature to a lower.

Descriptio n of heat	Hot and cold objects	Energy	Energy + transfer T_h $\rightarrow T_l$
Pre-test	13 %	40 %	7 %
Post-test 1	5 %	44 %	29 %

Table 2. Percentage of students who correctly drew the temperature shown on a thermometer, put it in melting water and boiling water and read the melting point of the substance from the graph.

Graphs	Melting ice	Heating of water	Reading the melting point
Pre-test	22 %	38 %	/
Post-test 1	22 %	31 %	/
Post-test 2	49 %	46 %	87 %

When do objects achieve thermal equilibrium? Thermodynamic equilibrium is achieved when there is no heat flow. This helps define the temperature. Laypersons usually relate thermodynamic equilibrium to the equal temperature of the objects. Table 3 shows that 44 % of students in the post-test 1 wrote that 2 objects are in the thermal equilibrium if they have equal temperature, while 28 % of students also added that there is no transfer of heat. While the thermometer is in the room, it maintains thermal equilibrium with the surroundings. The sketch of the graph time dependence of the temperature in this case was an easy task for

students, because 98 % of students draw it correctly in the post-test 2. Carlton (2000) found out as well that most often students are able to recognize that if two bodies are left in a room at a constant temperature for long enough, they will eventually reach the same temperature as each other and the room. 73 % of students correctly marked the area on the graph time dependence of the temperature for the mixture where it is in thermal equilibrium with the surroundings. In the next version of the teaching module, we will add two simple experiments to the laboratory work: the melting of ice and heating of water accompanied by the measurements of temperature which will clearly show that the temperature during the phase transitions is constant.

Table 3. Percentage of students who: a) described the thermal equilibrium with temperature and heat; b) correctly represented thermal equilibrium with the graph $T(t)$; and c) identified the thermal equilibrium from the graph.

	Q, equal T	equal T	T of thermometer in room	Reading the graph
Pre-test	3 %	38 %	80 %	/
Post-test 1	28 %	44 %	86 %	/
Post-test 2	/	/	98 %	73 %

In the fourth group of results, we sought answers to the questions "When does heat flow?" and "How much heat is transferred?" Table 4 indicates that 15 % of students in the pre-test and 51 % in the post-test 1 thought that heat flows from higher temperatures to lower temperatures, while 22 % of students in the post-test 1 still wrote that the difference in temperature does not cause the heat flux. The students were also required to draw a sketch of heat flows between parts of the cup with hot tea and its surroundings using arrows. A wide arrow represents a large heat flow. 24 % of students draw it correctly in the pre-test and 74 % in the exam (post-test 2). The percentage of students who draw it correctly was the highest immediately after a similar activity during the laboratory exercises (in the post-test 2). One third of the students encountered difficulties in the exam when reading a data about the area where there is no heat transfer between the mixture and the surrounding from graph $T(t)$.

Table 4. Percentage of students who: a) described the spontaneous heat flow without and with difference in temperature of the 2 objects; b) drew the sketch of heat flows for hot tea correctly; and c) recognized the area on graph $T(t)$ where there is no spontaneous heat flow between the mixture and its surroundings.

	no dT	dT	Sketch cup	Reading the graph
Pre-test	36 %	15 %	24 %	/
Post-test 1	22 %	51 %	82 %	38 %
Post-test 2	/	/	74 %	67 %

The results clearly indicate that the students were on average more familiar with the concepts related to heat and temperature, such as phase transition, heat transfer and thermal equilibrium after the application of the module. However, we also observed that some students regarded the experimental work only as a recipe showing how to conduct an experiment without trying to explain the physics behind it. In the new version of the module, we will add questions that would encourage student consideration from this point of view. The pre-service primary school teachers observed showed little interest to cooperate in collecting of data (except in the exams), therefore the questionnaires were very short. This is the main reason why we failed to gain the full impression of student knowledge, which partly limits the conclusions. The data was collected only by means of very short paper-pencil questionnaires with a few questions. Most questions were structured in a manner challenging only the lower cognitive level. However, to evaluate the real understanding of the concepts it is necessary to perform semi-structured interviews which can provide insights into student reasoning. For this reason, we have to schedule the preparation and implementation of semi-structured interviews before, in between and after the implementation of the teaching module. The prior study was conducted without a control group, therefore limiting the results. This might lead to a wrong conclusion regarding the influence of the experimental module related to the concepts of heat and temperature on achievements on test of knowledge. In the study, many suggestions for improvement of the module as well

as some instruments for collecting data were put forward. As many of these suggestions as possible will be considered when preparing the classes related to heat and temperature in the new school year. In this way, the impact of the module on understanding basic concepts related to heat and temperature might be described to a greater extent.

6. Conclusions

This paper describes the educational process of primary school teachers in the Slovenian school system. Primary school teachers teach all subjects, including physics contents in the subjects Environmental Studies and Science and Technology, from the 1st to the 5th grade. The concepts of heat and temperature are difficult to understand for pupils and students. For this reason, a teaching module related to heat and temperature for the first-year students of primary school teaching programme in Slovenia was designed and evaluated. The module leads the students through 8 hours of theoretical discussion on heat and temperature as well as experimental laboratory exercises that bring the concepts closer to students. The results show that the percentage of students who are able to discuss the meaning of thermal equilibrium, heat, and temperature increased after the application of the module. However, some gaps in their knowledge remain. Considering these results, a new version of the module will be prepared, the questionnaires will be updated and a pre-post study with a control group will be conducted in the school year 2014–15.

References

- Albert, E. (1978). Development of the concept heat in children. *Science Education*, 62(3), 389-399.
- Başer, M. (2006). Fostering conceptual change by cognitive conflict based instruction on students' understanding of heat and temperature concepts. *Eurasia* 2(2).
- Brush, S. G. (1986). The kind of motion we call heat: A history of the kinetic theory of gases in the 19th century. New York: North-Holland.
- Carlton, K. (2000). Teaching about heat and temperature. *Physics Education*, 35, 101-105.
- Edufile (2014). Education country file - Slovenia. Retrieved from http://www.edufile.info/index.php?view=school_systems&topic=topic_general_infos&country=22 (1.11.2014)
- Erickson, G. L. (1979). Children's conceptions of heat and temperature. *Science Education*, 63(2), 221-230.
- Jara-Guerrero S. (1993). Misconceptions on heat and temperature in The Proceedings of the Third International Seminar on Misconceptions and Educational Strategies in Science and Mathematics, Misconceptions Trust: Ithaca, NY (1993).
- Jasien, P. G., and Oberem, G. E. (2002). Understanding of Elementary Concepts in Heat and Temperature among College Students and K-12 Teachers. *Journal of Chemical Education*, 79(7), 889-895.
- Kolar, M. et al. (2011). *Učni načrt. Program osnovna šola. Spoznavanje okolja*. Ljubljana: Ministrstvo za šolstvo in šport: Zavod RS za šolstvo.
- Nottis, K., Prince, M., and Vigenat, M. (2009). Undergraduate engineering students' understanding of heat, temperature, and radiation. *Northeast educational research association*.
- Pathare, S. R., and Pradhan, H. C. (2005). Students alternative conception in pressure, heat and temperature *Physics Education*, 21(1), 213-218.
- Prince, M., and Vigeant, M. (2006). Using Inquiry-based Activities to Promote Understanding of Critical Engineering Concepts. Paper presented at the *ASEE National Conference*, Chicago, IL.
- Thomaz, M. F., Malaquias, I. M., Valente, M. C., and Antunes, M. J. (1995). An attempt to overcome alternative conceptions related to heat and temperature. *Physics Education*, 30 (1), 19-26.
- Vodopivec, M. et al. (2011). *Učni načrt. Program osnovna šola. Naravoslovje in tehnika*. Ljubljana: Ministrstvo za šolstvo in šport: Zavod RS za šolstvo.
- Yeo, S., and Zadnik, M. (2001). Introductory Thermal Concept Evaluation: Assessing Students' Understanding. *The Physics Teacher*, 39, 495-504.

Affiliation and address information

Jerneja Pavlin

University of Ljubljana, Faculty of Education
Department of Physics and Technical Studies
Kardeljeva ploščad 16
1000 Ljubljana, Slovenia
E-mail: jerneja.pavlin@pef.uni-lj.si

Chapter 3
Physics Teaching and Learning at Secondary Level

Probability and Amount of Data

Corrado E. Agnes

Polytechnic PhD School of Engineering, Turin, Italy

Abstract

Taken for granted the need to introduce the teaching of probability and the Shannon's measure for the amount of data, as part of the essential knowledge school must impart to the citizen, the vicious circle put into action when implementing the task is considered. Accounting for and building on the results of the cognitive science about probability and decision-making, the suggested introduction to probability is almost traditional in the substance, but the choice of words and analogies to make it more friendly, substantially change the conceptual approach. In the organization of the paper this is step one, developed in the two initial sections. A different approach is used for the amount of data, which is introduced without the traditional analysis with signs and messages, mainly to highlight the features that most parallel statistical physics. This is step two and is developed in the last two sections of the paper.

Keywords

Probability, Information, Data, Cognitive Biases

1. The problem of a citizen oriented teaching of probability.

At the Braga GIREP Conference [Agnes, 1994] I defended the need to introduce in science education the quantity invented by Shannon as a measure for the amount of data. Following the flow of data from everyday life examples, it could have been the way of understanding the "true logic of this world" with the side benefit of learning "the calculus of probability", as advocated by Maxwell in the famous quote. I believe the main thesis remains actual and valid, but a vicious circle was hidden in this hope, first discovered since long time by the mathematicians [Ramsey, 1926], [de Finetti, 1931] and later confirmed by cognitive scientists. Oversimplifying, the mathematical theory of probability needs to take into account human opinions, and probability judgments in daily life are deeply biased because of the human psychology. So that the essential tool for teaching of data, the calculus of probability, is made unavailable.

The following example adapted from medicine [Gigerenzer, 2008] convinced me, and I hope will convince the reader of the necessity of real changes in the teaching of probability to everybody who is not going to become a specialist. Let $0,001$ be the probability of being severely ill, so that $0,999$ is the probability of being sane. There is a test for this illness, which is $0,999$ positive if you are ill, and of course $0,001$ if you are sane. Having tested positive, what is the probability of being ill? This is an elementary exercise on *Bayes Theorem* and the answer is? Let's follow the first advice of the cognitive psychologist: to find 1 ill person we have to accurately scrutinize 1,000 people, and a reasonable sample for the problem is 1,000,000. Discourage the use of decimals (and percentages!) because the process of identifying one among many, look for the needle in the haystack, is less meaningful of the count of the trials for getting one (on the average): how many patients have to be treated for curing one, is what the doctor never says this way. The second advice is to encourage the tree diagrams that make the representation of the problem part of the solution: in Fig1a the splitting of the ensemble made by the illness is shown, together with the splitting made by the test: now it is easy to count the consistency of each group and evaluate the probability of about 0,5 (!). The same calculation applies to any large sample split according to the same proportions, now from law: a suspect is 50% guilty, notwithstanding he matches gender and race, $p=0,001$, and DNA test, $p=0,999$, with the perpetrator of a crime.

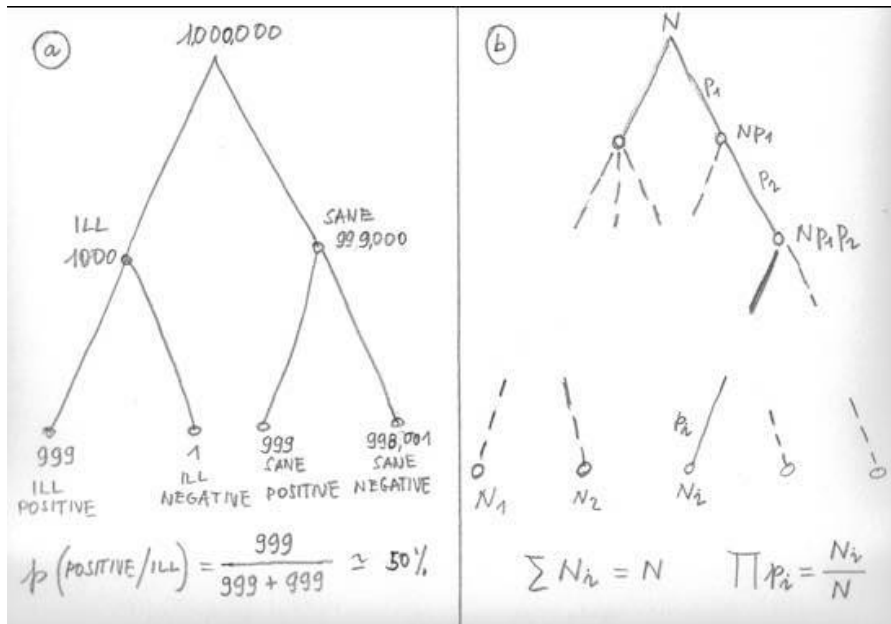

Figure 1. a) Illness Test Calculated Risk b) Sum and Product Rules for Tree Diagrams

Very different from what people answer, due to the “psychological effect” of the 999/1000 positive. The drive to jump to a conclusion, the discomfort with uncertainty is the characteristic of the automatic way of working of the human mind, the System One or “fast thinking”, in opposition to the “slow thinking” of the System Two [Kahneman, 2011]. The hope of large gains makes people seek risk and reject favourable settlement (possibility effect): they buy lottery tickets, because hope, however little, is important. The fear of disappointment makes people risk averse and accept unfavourable settlement (certainty effect): do you prefer to take 1000 \$ for sure or bet for 1500 \$ with probability 0,9 ?¹

Nothing of the traditional teaching went lost because the procedure is quite general and suitable for any probability problem. Namely the axioms we traditionally put at the beginning of probability theory are visible properties of the tree in Fig1b: each horizontal line at each level sums up to the total number; the path from any terminal point of the graph to the vertex reproduces the splitting factors, the compound probability as a product of probabilities.

¹ In the Kahneman-Tverski prospect theory, these are two examples out of the so called ‘fourfold pattern’.

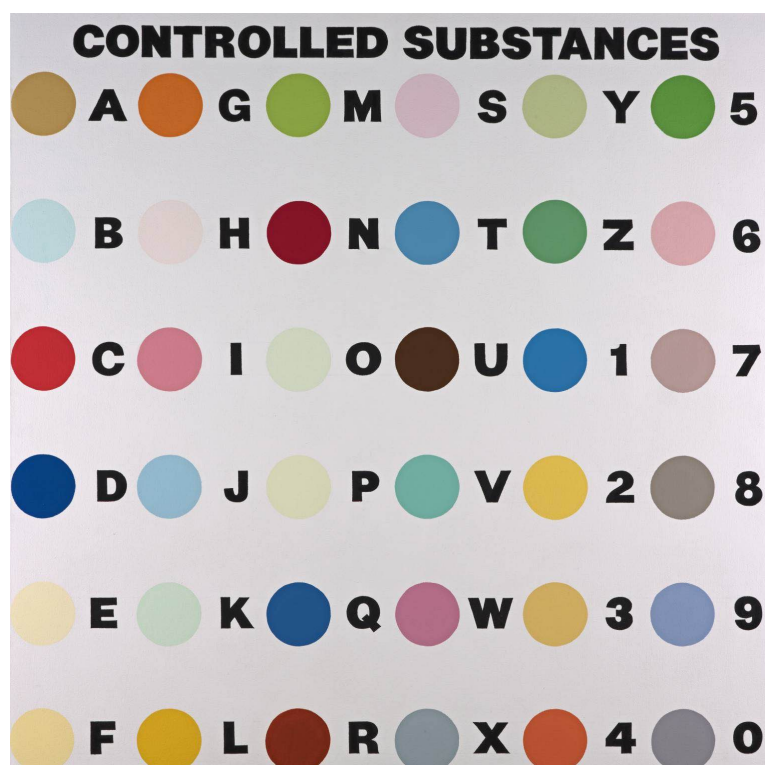

Figure 2. Damien Hirst: *Controlled Substances*, 1994, Tate Gallery, London

2. New words and old ideas for teaching probabilities.

The just summarized results of cognitive science, lead to think twice, before introducing probability in the usual abstract way, with events and fractions (a priori probabilities) and (a posteriori) frequencies, and favor a more friendly approach, counting with integer numbers individual items from groups. And to give probabilities a concrete physical meaning, I'll use the analogy with the *composition* of a *mixture*. Words used to speak about few particles at a time, a paradoxical situation for chemistry and the physics of gas, but not forbidden by the current laws, and words I'll use too for the spot paintings by Damien Hirst of Fig2, the example I chose to find support for the communication from the original gaze of an artist. On one side they have titles inspired by an imaginary chemistry, on the other they remember the urns full of colored marbles of the exercises on probability, and of course the particles of statistical physics. I believe these pictures are useful to introduce the problem of distinguishable, not distinguishable, identical and diverse elements of the set, to which I'll extend the idea that otherwise "*identical particles*" could be considered diverse chemical substances, if they differ in the values of a physical quantity [Einstein, 1914], [Job, 2007]. In our example the color of the marbles, so that the ratios of the number N_i of individuals of the species i to the total number N , measure the composition of the set. The same ratios N_i/N evidently represent the relative concentrations when the mixtures are physical and probabilities in the case of mathematical urns. It is not the first time the same quantity is invented to deal with similar problems in different fields. By chemists when the substances are accessible and can be analyzed quantitatively and qualitatively, by mathematicians when the set is accessible only one item at a time, and only as far as in the future!

So that "concentration of a mixture" becomes "possibility of choice". Words full of arbitrariness, which take us nearer to our subject, but I want to show that some arbitrariness is also hidden in the description of a mixture. It is well known that chemists represent mixtures with variables very similar to coordinates, not position in space but composition in the space of substances. What is less known is that also in substance space we can arbitrarily choose the "axes" to the extent of taking "gedanken substances" as reference substances. The substance reference system is not given by nature, but follows and adjusts the new discovered substances². The point of the comment is that the arbitrariness embodied in the judgment if two elements are identical or diverse is of the same type of the choice of the substance coordinate system, so that in the examples from the paintings, the judgment of identical or diverse colors is subjective, but not contradictory with the rules of the calculus of probability, as well as with probability distributions based on

² This notion well exposes the rhetoric of divulgation about "the ultimate building blocks of matter".

opinions. The terms uncertainty-indeterminacy pollute the usual verbal environment of probability with fatal consequences for the teaching, but they are in no way related to probabilities. Probabilities may be unknown, or may be arbitrary in the sense of the choice of the coordinate system, or they are imprecise in the usual physical sense, but they are never uncertain neither indeterminate.

The basic idea is to introduce probability before and independently of data amount, so that we go from step one, where probability is introduced starting from the composition of a set, to step two, where a new property of the set is defined, based on probabilities.

Taking the summary of the main differences from the traditional teaching of probability: the concept and terminology of “events” is substituted with “substance portions” and their ratios, and the calculus of probabilities is not performed by the repeated application of the two theorems of Fig.1b to real numbers between 0 and 1. Instead a subset with the desired characteristics is chosen from the tree representation of the total set, and its elements are counted by integers, what cognitive scientist call “natural frequencies”.

Avoiding the use of “probable and possible events” postpones the didactical and psychological problems connected with uncertainty and undeterminacy. They are of course unavoidable, but they belong to another physical quantity, the one built on probabilities exactly with the aim to measure quantitatively the uncertainty-indeterminacy!

I believe a better term to deal with these problems is “doubt”. A set of diverse objects offer the possibility of choice and this creates the embarrassment of choice, the doubt.

It is important to be aware from the beginning of the special feature of the coming physical quantity, because if the number of choices is kept fixed, it increases and maximizes when the choices are equally attractive, or without preference at all, or full of indifference; as we learnt from Hamlet, Jules et Jim³ and equilibrium statistical physics!

3. Words and Ideas for teaching Data

How to measure doubt, but before that, what physical system has this doubt as its property? Of course the person who is ready to draw a marble, but from the point of view of physics it is a property of the urn, as well as the number of choices is too a property of the urn. Here is where the human psychology makes thing difficult! The “doubt” is in the urn and is not a decision of the blindfolded goddess, whom the System One of the human thinking takes responsible, in its action-oriented search for a cause.

Let’s have an urn, a box with only one marble, or two or three or more ... but identical: this box cannot create any doubt because it does not offer any choice, so that the measure for the doubt we are looking for has the value zero, whatever be the unit of measure we don’t have yet! Let’s have a second box full of the same number of identical marbles, so that the value for the second box is also zero, because identity has been defined locally and the boxes are separated. Now we make a gedanken experiment: we put both sets in the same box separated by a wall that is removed. Like the famous gedanken experiment from statistical physics⁴, this one too has different outcomes if the marbles are all identical, so that the “doubt” remains zero, or if the marbles, through the process of mixing, “recognize their diversity”. In this case the diversity creates the possibility of choice, and this choice is independent from the actual number of marbles, it depends only from the composition, so it is the same for a box containing the minimum number of marbles that guarantees the same choice and the same doubt: only two marbles! We choose this “little bit” as the physical system that represents the unit of the quantity used to compare the amount of data of any other physical system.

Before leaving this analogy between composition and probability, let me point to a correspondence, which seems of no use, if not to remind us that analogies are not right or wrong but useful or useless. And when analogy points to some unlikeness, it may as well be useful to stress the diversity, like the well-known didactic weapon of the counterexample.

The mathematical union of two sets is obviously analogous to the mixture, but the direct product of sets does not seem having any useful meaning related to substances: but in probability theory and amount of data computation it becomes the key concept. Think of the multiple-choice problem, the direct product of the sets represents the combined independent possibilities. In the tree representation this amounts to the splitting of the same set according to diverse criteria, diverse probability distributions as in Fig3b. In the language of sets, each level of the “tree of hands⁵” is the direct product of the set at upper level and the set of the new choices. Repeated trials lead immediately to the “power” sets and one example is the binary tree of the Fig3a. From now on let’s use standard terminology, bit for the unit and data for the quantity and H for the

³ French film directed by François Truffaut in 1962.

⁴ Gibbs Paradox.

⁵ Because fingers are for choosing! The expression came out of an experimental session with children.

symbol⁶, bit/s for the unit of the current, rate of transfer of data symbol I_H , trying to avoid commercial terminology about power or velocity of data transfer; and also limit the use of words like choice and doubt which I consider useful for understanding, but, like all words, they inevitably carry more meanings, and we want to be restricted to the precise physical meaning. The idea for evaluating the data amount of a generic set is operative, and comes directly from the freedom of choice of the substance reference system. We build the set from “nothing”, that is, after having “identified” all the objects, we begin with a set of identical objects, which we know has data amount equal to zero. Then we gain knowledge about the set “diversifying” it step by step, until we reproduce the actual set. Let’s go back to the tree representation in the very special case in which the choice is at each step binary, as in Fig3a. Beginning with a set of $N=2^n$ identical objects, which diversifies and halves at any branch, we observe that the amount of data increases of 1 unit at each level, so that the quantity is simply evaluated by the exponent of 2, that is the base 2 logarithm $H = n = \log_2 N \text{ bit}$. To be convinced the result is valid for any N , we consider a pure multiplicative tree, that is a tree in which all the paths from the vertex to the base consist of the same factors as in the example in Fig3b: $N=3*2*5*...$. The number of choices from one level to the next gets multiplied while the amount of data adds, because being additive is the “must” requirement of a measure: exactly the functional definition of the logarithm: $H(3*2*5) = H(3)+H(2)+H(5)$.

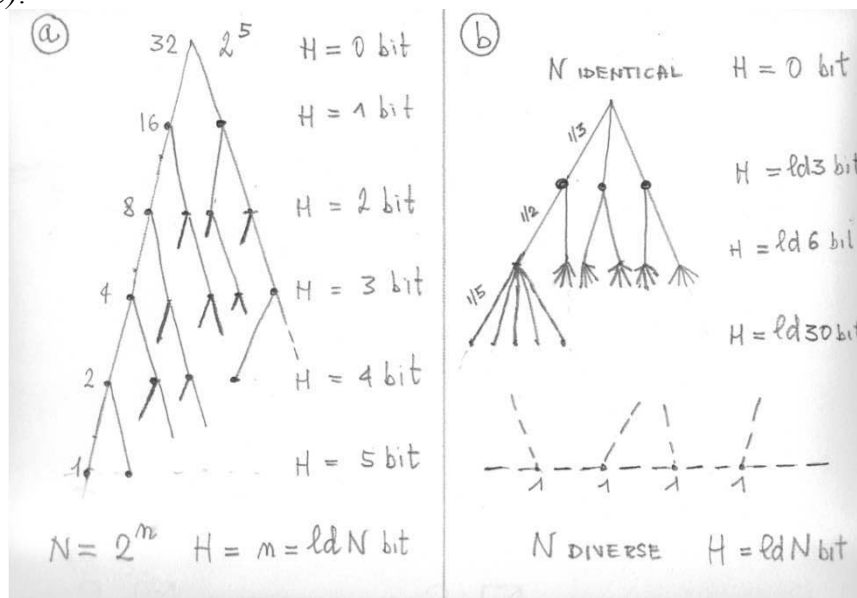

Figure 3. a) Binary Tree b) Pure Multiplicative Tree

To obtain the general formula we look to a generic terminal of the tree, reached by a branch carrying the compound probability of the path, which we calculated in Fig1b; so that its contribution to the total amount of data will be $\log N/N_i$, weighed with the factor N_i/N due to the sum rule, and the final result is the Shannon formula:

$$H = - \sum p_i \log p_i = \sum \frac{N_i}{N} \log \frac{N}{N_i}$$

A final comment is important: the winner of the N tickets of the lottery, together with all the ones which gave us hope and lost, carry the amount of data $\log N \text{ bit}$, only before the extraction. After the choice has been physically made, all of them become ascertained events, which carry $H=0 \text{ bit}$, exactly the same value of the impossible event, the extraction from the lottery urn of something which is not there.

Now we can connect the mathematical theory with the practice of communication [Shannon, 1949]: the physical system which prepares the message, choosing the signs one by one, the “Emitter”, behaves like we did preparing the microstates of the system in statistical physics. But for the physical system “Receiver”, the message carries the data corresponding to the choices made by the sender, because it does not know them yet.

The reason for leaving aside messages and signs during the introduction of data measure, may come from the

⁶ From Boltzmann H theorem, maybe with the Greek capital E of entropy?!

“germinal quotation mark” put in the following phrase: “the ‘meaning’ of a message is irrelevant”, by Shannon himself [Gleick, 2011]; but the very reason is to pave the way to the recognition of the Shannon measure as a legitimate physical quantity, as we’ll show in the last section. The main difference with the traditional teaching is to build directly any amount of data from $H=0$ bit, through a process of differentiation and identification, instead of finding an additive measure, that is the logarithm of the total number of different messages. Consequently the unit *bit* is not defined starting with the set of two signs, which is the simplest, but let me say, with the “elementary quantum of diversity”. Of course it is only the reverse of the traditional formulation, but also here the conceptual approach is substantially changed.

4. Brand New and Used Up Physical Quantities

To bring the quantities measured in *bit* and *bit/s* from the virtual computer world to the physical world, I need first to persuade teachers of science that data is a legitimate physical quantity. Let’s take the following simple but theoretically sound definition: a physical quantity is a relation between physical systems, which becomes a property of the physical system. As shown by the prototypical example of length: the relation of things with the stab in Paris has become the property length. [Falk, 1990]. This is exactly what we did when the message, which is the relation with the set of signs, became its data, and the relation between the emitter and the receiver became the current of data carried by the physical connection of the two.

Thus far I thoroughly used “amount of data”, or simply “data”, and accurately avoided the term “information”, to take advantage from the simplicity of representing the data as “contained in” and “transferred to” physical systems, and to minimize undesired extra information and unnecessary obstacles for the understanding process. In the words of Shannon [Gleick, 2011], his ‘Information’ although related to the everyday meaning of the word, should not be confused with it. The confusion is due to the “value” of the information, and to the increasing amount of unavoidable data, which have been well expressed by the pregnant new word Dataclism [Rudder, 2014]. Our continuing infatuation with Big Data [Mayer-Schönberger, Cukier, 2013] comes from the harmful idea that the increasing quantity of data could become a quality in itself: the mirage of possessing “All the Data” can be dissolved only by the familiarity with this physical quantity and its conceptual content. Of course the question about the “value” of data is important but up to now has no answer according to physics. Whenever a physical quantity appears to have a diverse “value”, like for example one cubic meter of water, when in the sea or in the dam, the physical answer is to look for another physical quantity which can tell the diversity. Thermodynamics tells us that, in the water example, energy plays that role, and the gravitational potential is the right quantity to measure this very “value”. The amount of data is not a primary energy carrier [Herrmann, Schmälzle, 1987], their transfer is convective, they are carried together with other physical quantities: a specific quantity carried with data, which could be useful in relation to the value of information, has not yet invented, but probably is on the way. Maybe a final observation on the “value of information” can be useful: the peculiar aspect of data in relation with the “true” and “false” dichotomy. Suppose we make a copy of each object (no data added) then label a twin pair true and false. The computation of the data increase results in 1 bit, only because the number N of objects is doubled: $H(2N)=H(N)+1$ bit.

Everything points to the fact that data is a new physical quantity, but I disseminated hints from statistical physics that it has a close relation with entropy, and Shannon clearly wrote it [Shannon, 1949 §6,7]. With our definition of physical quantity we can easily understand why sometimes new physical quantities are not diverse from the old ones, used in diverse contexts. Because between two physical systems we can have different relations, each one becoming a different property of the system. Also the analogy I used to introduce probability points to this: I could tell probability has been discovered / invented three times. Once by proto-chemists as mixing ratios, later by mathematicians and I like to add the contribution of statistical physicists as independent, not as applied mathematics, [Maxwell, 1860], [Boltzmann, 1872], [Gibbs, 1903]. And from Maxwell and his famous quote I take the conclusion, recalling his dedication to popularization as a form of teaching, hoping that, once made the weapon probability more handy, the amount of data, once embedded into everyday life, be fit to quantify the least quantifiable properties of the real world. To confine it within specialized boundaries is a collateral damage both for education and culture.

References

Agnes, C.E., (1994). The Missing Quantity in Physics Education. In Pereira L.C., Ferreira J.A., Lopez H.E. (Ed.), *Girep 1993 Proceedings of the conference on Light and Information*, (pp.260-264). Braga: Universidade do Minho.

- Boltzmann, L., (1872). *Further Studies on the Thermal Equilibrium of Gas Molecules* ("Weitere Studien über das Wärmegleichgewicht unter Gasmolekülen"), in Sitzungsberichte der Akademie der Wissenschaften, Mathematische-Naturwissenschaftliche Klasse (pgs. 275-370), Bd. 66, Dritte Heft, Zweite Abteilung, Vienna: Gerold.
- de Finetti, B. (1931). *The True Subjective Probability Problem*, http://link.springer.com/chapter/10.1007/978-94-010-2288-0_2#page-1
- Einstein A., (1914). Beiträge zur Quantentheorie, *Verh. Deut. Phys. Gesell.* **XVI**, 820–827 (see also: Contributions to Quantum Theory, in *The Collected Papers of Albert Einstein*, 1997, **6**, Princeton University Press, 20–26.
- Falk, G., (1990). *Zahl und Realität*, Birkhäuser, Basel, Switzerland.
- Gibbs, J.W., (1902). *Elementary Principles in Statistical Mechanics: developed with especial reference to the rational foundation of thermodynamics*. Nabu Public Domain Reprints.
- Gigerenzer, G., (2008). *Calculated Risk: How to Know when Numbers Deceive You*, Simon & Schuster New York, USA.
- Gleick, J., (2011). *The Information*, Random House, New York, USA.
- Herrmann, F., Schmälzle, P., (1987). *Daten und Energie*, J.B.Metzler + B.G.Teubner, Stuttgart, Germany.
- Job G., (2007). *An Elementary Approach to Quantum Statistical Problems*, Eduard-Job Foundation preprint (the paper can be requested at sekretariat@job-stiftung.de).
- Kahneman, D., (2011). *Thinking, Fast and Slow*, Farrar, Straus and Giroux, New York, USA.
- Mayer-Schönberger V., Cukier K., (2013). *Big Data*, Houghton Mifflin Harcourt, New York, USA.
- Maxwell, J.C. (1860). Illustrations of the dynamical theory of gases. Part I. On the motions and collisions of perfectly elastic spheres, *Philosophical Magazine, 4th series, 19 : 19-32*. Illustrations of the dynamical theory of gases. Part II. On the process of diffusion of two or more kinds of moving particles among one another, *Philosophical Magazine, 4th series, 20 : 21-37*.
- Ramsey, F.P., (1926) *Truth and Probability* <http://fitelson.org/coherence/ramsey.pdf>
- Rudder, C., (2014). *Dataclysm*, Crown Publishers, New York, USA.
- Shannon, C.E., Weaver, W., (1949). *The mathematical theory of communication*, University Press Urbana, USA. <http://worrydream.com/refs/Shannon%20-%20A%20Mathematical%20Theory%20of%20Communication.pdf>

Affiliation and address information

Corrado Enrico Agnes
 Polytechnic PhD School of Engineering, Turin, Italy
 Corso Duca degli Abruzzi 24
 10129 Turin
 Italy
 e-mail: corrado.agnes@polito.it

From Naive to Scientific Understanding of Motion and its Causes

Alessandro Ascari¹, Federico Corni¹, Gabriele Ceroni², Hans U. Fuchs³

¹ *University of Modena and Reggio Emilia, Italy*

² *University of Bologna, Italy*

³ *Zurich University of Applied Sciences at Winterthur, Switzerland*

Abstract

The difference in the descriptions of motion phenomena made by pupils in the first grades of secondary school and physicists is quite evident. Conceptual metaphors hidden in language suggest that there is continuity between the conceptual structure involved in the description and the interpretation of motion of experts and laypersons. In this paper the presence of such a continuity is shown through a metaphor analysis of linguistic expressions from both kind of people.

Keywords

physics education; language; conceptual metaphor; continuity

1. Introduction

We know from literature (DiSessa, 1993; McCloskey, Caramazza, & Green, 1980) that students face difficulties in studying motion and its causes. We argue that if we want to address these problems, we have to investigate the conceptualization of motion.

We are going to investigate the conceptual structure involved in the description of motion of laypersons, i.e. the students, and of experts, i.e. teachers, scientists, physicists. We argue that some kind of continuity should be present between these two kinds of conceptualization and that physics education should be built on it.

In the first part of this article we are going to illustrate how it is possible to understand how the concept of motion is constructed in human mind. A theory that relates mind and language is presented starting from the works of Lakoff, Johnson, Turner and Fauconnier.

In the second part we will show the analyses carried on two different sources of language, the first representing the scientific conceptualization, the second the lay one.

In the last part the evidences and the results of the analyses are presented and discussed.

2. A theory of mind

In cognitive linguistics, conceptual metaphor is defined as understanding one conceptual domain (target domain) in terms of another conceptual domain (source domain). Lakoff, Johnson and Turner underline the deep and strong connection between language and mind. According to these authors, the nature of the conceptual structure that we use to think, speak and act is figurative. As a consequence of this, conceptual metaphors play an important role in structuring knowledge. They are systematic in that there is a fixed correspondence between the structure of the domain to be understood (e.g., death) and the structure of the domain in terms of which we are understanding it (e.g., departure). We usually understand them in terms of common experiences. They are largely unconscious, though attention may be drawn to them. Their operation in cognition is almost automatic. And they are widely conventionalized in language, that is, there are a great number of words and idiomatic expressions in our language whose meanings depend upon those conceptual metaphors (Lakoff & Turner, 1989). Metaphor is no longer seen as a mere linguistic and aesthetic feature: the cognitive role of metaphor emerges in the process of structuring and acquiring new knowledge. In synthesis, a *concept* is *constituted* by the *metaphor* (Lakoff & Johnson, 1980).

Moreover, according to Fauconnier and Turner, in human mind there are entire networks of projections between conceptual spaces leading to what have been known as *conceptual integration networks* (Fauconnier & Turner, 1998, 2002; Fauconnier, 1994, 1997).

As a consequence of this, we can understand the way we think, our conceptualization of motion, looking at the way we speak, in particular at the conceptual metaphors implied in the language we use to talk and to describe motion.

We have to make a distinction between metaphor and metaphoric linguistic expressions: the latter is what we hear or read when somebody uses a metaphor, the former is a figure of the mind, we might say the actual concept. We will show an example in order to evidence the difference.

Heat flows through the walls of the building

is the metaphorical expression of the metaphor:

HEAT IS A FLUID SUBSTANCE

We will use this convention in order to differentiate the conceptual metaphors from the metaphorical expressions.

3. Language analyses

In order to compare the two forms of conceptualization of motion we selected two sources of sentences about motion: the first volume of “The Feynman lectures on Physics” (Feynman, 1965) as a source of scientific language and recordings of college students enrolled in physics courses collected in the paper “Common sense concepts about motion” by Halloun and Hestenes as a source of lay language (Halloun & Hestenes, 1985).

We looked for the sentences containing the word “force” and we tried to see the underlying conceptual metaphor. We constructed the categories of conceptual metaphors in a recursive way in order to have the more general and encompassing ones. We developed the conceptual metaphors categorization starting from the Force Dynamic Gestalt theory (Fuchs, 2007), image schemas (Johnson, 1990) and event structures (Lakoff & Johnson, 1999).

Here we present the list of metaphors involved in the description of the word “force”.

5. FORCE IS A SUBSTANCE-LIKE QUANTITY
 1. FORCE IS A PRODUCT
 2. FORCE IS A QUANTITY
 3. FORCE IS A POSSESSION
6. FORCE IS AN AGENT
 1. FORCE IS A COMPULSION
 2. FORCE IS A RESISTANCE
7. FORCE IS A MEDIUM
8. FORCE IS A PATH
 1. FORCE IS A LINE
 2. FORCE IS A CONNECTION
9. FORCE IS A SCALE
10. FORCE IS BALANCE

The complete list of categorized sentences is presented in the following tables (1-6). The first observation is that sentences coming from both expert and lay language are metaphorical expressions contained in all these categories.

Besides that, we also found some differences in the metaphorical expressions coming from the two sources.

Table 1. FORCE IS A SUBSTANCE-LIKE QUANTITY expressions

Conceptual metaphor sub-category	Feynman expressions	Students expressions
FORCE IS A PRODUCT	<i>This potentiality for <u>producing</u> a force is called an <u>electric field</u>. A <u>source</u> of the force.</i>	<i>The speed <u>creates</u> a force. The force behind it...<u>coming from</u> the throw.</i>

FORCE IS A QUANTITY	<i>How much force would there be? More or less force is required. There is very little force at any appreciable distance.</i>	<i>As it goes down, the force of gravity increases...and that's why the speed increases until [gravity] equals this amount of force. It provides the ball with more and more force as it goes down.</i>
FORCE IS A POSSESSION	<i>A spinning top has the same weight as a still one. The weight of the atom. These forces are within the nuclei of atoms.</i>	<i>If the mass of block X is greater than the force [of pull] of Y, block X stays in place...it could not be moved. [The moving body] has still got some force inside.</i>

FORCE IS A PRODUCT conceptual metaphor (Table 1) tells us that force could be “produced”. The possible “producers” in Feynman expressions are the basic interactions between objects, i.e. electrical and gravitational, while in students expressions the “producers” are speed and aspects of motion.

In FORCE IS A QUANTITY metaphorical expressions (Table 1), Feynman only speaks about the intensity of force, while in students' language we find expressions that are related to the concept of momentum or energy of a moving object.

Finally, the metaphorical expressions of FORCE IS A POSSESSION (Table 1) in Feynman are only about weight, while in laypersons we have expressions involving moving objects, devices that produce movement (i.e. a cannon), and more abstract concepts as power, inertia and velocity.

Table 2. FORCE IS AN AGENT expressions

Conceptual metaphor sub-category	Feynman expressions	Students expressions
(unsorted)	<i>The first charge will feel a certain reaction force.</i>	<i>There is not a force [acting on] on the ball. Gravity means the same force pulls on different objects.</i>
FORCE IS A COMPULSION	<i>Because of the action of a force, the velocity changes. The force which controls, let us say, Jupiter in going around the sun.</i>	<i>A force only starts the motion. A force is just changing the direction of motion.</i>
FORCE IS A RESISTANCE	<i>It is a question of electrical forces against which we are working. No tangential force is needed to keep a planet in its orbit.</i>	<i>A force has nothing to do with the speed, it only has to keep the ball moving.</i>

Table 3. FORCE IS MEDIUM expressions

Feynman expressions	Students expressions
<i>We shall have to hold the piston down by a certain force. The gas exerts a jittery force.</i>	<i>That maximum speed is always equal to the force you apply.</i>

Table 4. FORCE IS A PATH expressions

Conceptual metaphor sub-category	Feynman expressions	Students expressions
----------------------------------	---------------------	----------------------

FORCE IS A LINE	<i>The force <u>in the vertical direction</u> due to gravity.</i> <i>The force is <u>directed along the line</u> joining the planet to the sun.</i>	<i>The ball goes out <u>in the direction</u> of the resultant [of the forces].</i>
FORCE IS A CONNECTION	<i>The true nature of the forces <u>between the</u> atoms.</i>	none

Table 5. FORCE IS A SCALE expressions

Feynman expressions	Students expressions
<i>The force <u>weakens</u> as we go higher.</i> <i>The more massive a thing is, the <u>stronger</u> the force required to produce a given acceleration.</i>	none

Table 6. FORCE IS BALANCE expressions

Feynman expressions	Students expressions
<i>If the force between them were not <u>balanced</u>.</i> <i>Talk only about <u>excess</u> forces.</i> <i>All the internal forces will <u>balance out</u>.</i>	none

Some metaphorical expressions found in Feynman are not present in students expressions, but we think this could be due to the set of data chosen for this purpose. We are almost sure that similar sentences could be found in students expressions if only we could have a larger collection.

The metaphorical sentences in lay language often involved the terms “speed” or “velocity”. In order to deepen our investigations we repeated the same analysis for the sentences containing these two words.

The conceptual metaphors we found are listed below.

- SPEED IS A SUBSTANCE
 - SPEED IS A POSSESSION
 - SPEED IS A QUANTITY
- SPEED IS A LOCATION
 - SPEED IS A LEVEL
 - SPEED IS A SCALE
- SPEED IS AN AGENT
 - SPEED IS A FORCE
 - SPEED IS A MAKER

Table 7 collects the categorization of the metaphorical sentences found in both set of data.

Table 7. Speed and Velocity metaphors and metaphorical expressions

Conceptual metaphor category	Conceptual metaphor sub-category	Feynman expressions	Students expressions
SPEED IS A SUBSTANCE	SPEED IS A POSSESSION	<i>Motion <u>of</u> a body.</i> <i>If she kept going <u>with</u> the same speed.</i> <i>The velocity <u>of</u> the falling ball.</i>	<i><u>Its</u> speed remains constant.</i> <i><u>Their</u> speed gets greater and greater.</i> <i>Both should <u>have</u> the same speed.</i>
	SPEED IS A QUANTITY	<i>[...] if we <u>increase</u> the speed of the atoms.</i>	<i>Its velocity keeps <u>increasing</u>.</i> <i>The speed is <u>smaller</u>.</i> <i>A new speed <u>bigger</u> than the one it had before.</i>
SPEED IS A LOCATION	SPEED IS A LEVEL	<i><u>At</u> what speed is the radius increasing?</i> <i>She is going <u>at</u> that speed.</i> <i>Some car can <u>get from rest to</u> 60 miles an hour.</i>	<i>The ball must go <u>at</u> constant speed.</i> <i>They can <u>reach</u> a speed limit.</i>
	SPEED IS A SCALE	<i>It speeds <u>up</u>.</i> <i>The car was slowing <u>down</u>.</i> <i><u>High</u> speeds.</i>	<i>It speeds <u>up</u> for a short while.</i> <i>It slows <u>down</u>.</i>
SPEED IS AN AGENT	SPEED IS A FORCE	none	<i>The <u>force</u> due to the air <u>overcomes</u> the initial velocity.</i> <i>The <u>force</u> <u>of</u> velocity.</i>
	SPEED IS A MAKER	none	<i>The speed <u>creates</u> a force.</i>

All the expressions belonging from the two sources fitted all these categories with only one exception. Metaphorical expressions belonging to SPEED IS AN AGENT can only be found in students language.

4. Results and conclusions

This metaphor analysis is a powerful and sensible tool that allows us to investigate the conceptual structure that both scientists and students use to understand and to explain phenomena.

The first important result is that the metaphorical expressions coming from both lay and expert language share the majority of the metaphors. This allows us to claim that there is continuity between the two kind of language.

We also revealed a metaphorical and conceptual mismatch involving velocity and speed. In the analysis we discovered that SPEED IS AN AGENT is a conceptual metaphor only present in lay language (students). Therefore we could say that speed (and velocity) is perceived and conceptualized as an agent only by laypersons (students), while this is not true for scientists and experts (Feynman).

Another important result is that some aspects coming from the Force Dynamic Gestalt theory, such as quantity, quality, intensity (Fuchs, 2007) are present in the metaphorical expressions. Moreover they are not completely differentiated in lay language.

The presence of continuity tells us that it is possible to teach starting from the knowledge pupils have already developed during their previous experiences: we could use conceptual metaphor as a basis for developing a physics curriculum.

Physics teachers should be aware of the conceptual metaphors and how they relates and overlap in order to create comprehension (i.e. conceptual integration networks). In this sense we could say that an education based on conceptual metaphors could help students to be aware of them in order to understand and relate the aspects involved in the interpretation of motion and its causes.

In order to do so further analysis should be done in order to reveal the logical connections and the dependencies between concepts involved in the description of motion (momentum, energy). A refined analysis should be done taking different language sources, both oral and written.

References

- DiSessa, A. A. (1993). Toward an epistemology of physics. *Cognition and Instruction*, 10(2/3), 105–225.
- Fauconnier, G. (1994). *Mental Spaces: Aspects of Meaning Construction in Natural Language*. Cambridge, UK: Cambridge University Press.
- Fauconnier, G. (1997). *Mappings in Thought and Language*. Cambridge, UK: Cambridge University Press.
- Fauconnier, G., & Turner, M. (1998). Conceptual integration networks. *Cognitive Science*, 22(2), 133–187. doi:10.1016/S0364-0213(99)80038-X
- Fauconnier, G., & Turner, M. (2002). *The way we think*. New York, NY: Basic Books.
- Feynman, R. P. (1965). *The Feynman Lectures on Physics*; Vol. I. *American Journal of Physics* (10th ed., Vol. 33, p. 750). Addison Wesley. doi:10.1119/1.1972241
- Fuchs, H. U. (2007). *From Image Schemas to Dynamical Models in Fluids, Electricity, Heat, and Motion. An Essay on Physics Education Research*. Winterthur, Switzerland. Retrieved from <https://home.zhaw.ch/fuh/LITERATURE/Literature.html>
- Halloun, I. A., & Hestenes, D. (1985). Common sense concepts about motion. *American Journal of Physics*, 53(November), 1056–1065. doi:10.1119/1.14031
- Johnson, M. (1990). *The Body in the Mind*. Chicago: University of Chicago Press.
- Lakoff, G., & Johnson, M. (1980). *Metaphors We Live By*. Chicago: University of Chicago Press.
- Lakoff, G., & Johnson, M. (1999). *Philosophy in the flesh: The embodied mind and its challenge to western thought. The Embodied Mind and its Challenge to Western ...* Basic Books.
- Lakoff, G., & Turner, M. (1989). *More Than Cool Reason: A Field Guide to Poetic Metaphor*. Chicago: University of Chicago Press. Retrieved from <http://books.google.it/books?id=pz9TveJ5N5QC>
- McCloskey, M., Caramazza, A., & Green, B. (1980). Curvilinear motion in the absence of external forces: naive beliefs about the motion of objects. *Science (New York, N.Y.)*, 210(4474), 1139–41. doi:10.1126/science.210.4474.1139

Affiliation and address information

Alessandro Ascari
 Doctoral School in Humanities
 Department of Communication and Economics
 University of Modena and Reggio Emilia
 viale Antonio Allegri, 9
 42121 Reggio Emilia
 Italy
 e-mail: alessandro.ascari@unimore.it

Federico Corni
 Department of Education and Humanities
 University of Modena and Reggio Emilia
 viale Antonio Allegri, 9
 42121 Reggio Emilia
 Italy
 e-mail: federico.corni@unimore.it

Gabriele Ceroni
 CIS - International Centre for the History of Universities and Science
 Department of Philosophy and Communication
 University of Bologna
 via Zamboni, 38
 40126 Bologna
 Italy
 email: gabriele.ceroni@studio.unibo.it

Hans U. Fuchs
 IAMP - Institute of Applied Mathematics and Physics
 School of Engineering
 Zurich University of Applied Sciences

8401 Winterthur
Switzerland
email: hans.fuchs@zhaw.ch

High School Students Face the Magnetic Vector Potential: some Relapses in their Learning and Tips for Teachers Dealing with Electromagnetism

Sara R. Barbieri, Marco Giliberti

University of Milan, Italy.

Abstract

Although the magnetic vector potential is currently treated at university level in electromagnetism and modern physics courses, in secondary school it is never introduced. On the contrary, a quite important place is given to the electric scalar potential, especially in connection with the description of electrical circuits, thus creating a certain asymmetry in the didactical presentation of the electric and magnetic fields.

Here we present the results of an experimentation carried out with 25 secondary school students to whom we have introduced the magnetic vector potential using the integral tools of circulation and flux, in close analogy with the usual presentation of the electrostatic scalar potential in secondary school. Since these mathematical tools are the same that students use for writing Maxwell's equations, our strategy for the introduction of the vector potential is also useful to strengthen and improving students' learning of more common and basic concepts in electromagnetism. Besides a description of what can be done in classroom work, here we also present some considerations for teachers to further motivate the introduction of vector potential in secondary school. In particular we deal with some opportunities provided by a re-writing of the Maxwell's equations in terms of potentials. Therefore, we outline connections between electromagnetism and special relativity, so to highlight the importance of vector potential in addition to the traditional scalar potential in a modern presentation of electromagnetism at high school level.

Keywords

Electromagnetism, vector potential, secondary education.

1. Introduction

The idea of treating the vector potential \mathbf{A} in secondary school has come out when we decided to deal with superconductivity. In order to keep mathematical consistence between the physical experiments performed in lab-room on superconductivity and their theoretical explanation, we found that the vector potential could be a very important tool if one does not want to give students only popular explanations. Although secondary students lack of the standard mathematical background of differential operators, generally needed to face the definition of magnetic vector potential, we found it possible to introduce the vector potential by means of integral notions, thus remaining in the standard secondary school mathematical formalism, already used in electromagnetism.

Besides its application to give a phenomenological explanation of superconductivity, we found that the importance of \mathbf{A} is great in itself, not only for advanced physics university courses, but also for a deeper understanding of secondary school physics. In fact, magnetic vector potential, together with the electric scalar potential, can shed light on some interesting, though simple, problems of electromagnetism, open many didactical opportunities towards relativity and quantum physics and give many hints for discussing the meaning of physical quantities.

Our aim in this work is double: from one hand, we would like to show that it is worth trying to include vector potential into secondary school curriculum, and on the other hand we will delineate some reflections for teachers about some fundamental concepts pertaining electromagnetism and symmetry. In fact, despite its shortness, an important leitmotif of this paper is the concept of symmetry, that should be recognized as one of the most useful guides, not only in physics itself, but also in physics education.

2. Experimentation at high school on the vector potential

We present here some of the result of an experimentation that we carried out with 25 high school students attending their last year (13th grade) of a scientific high school.

The curricular teacher gladly accepted to enrol their students in the proposed experimentation, even though he thought they had a very poor disciplinary preparation: students were used to a basically mnemonic study and unable of solving very simple text-book problems (they even found difficulties in substituting numbers into a given mathematical formula). Nevertheless, students were all aware of their poor disciplinary preparation of which, even, often nicely apologized with the experimenter throughout the lectures of the path.

We monitored students' learning process with oral interviews before and during the path and with two written tests. The two tests, that were given to students before and after the path on vector potential, were identical and did not contain any explicit question regarding the vector potential itself, but investigated students' competencies on basic concepts of electromagnetism and its mathematical formulation. Students' competencies about vector potential have been investigated later with other tests and interviews, that for brevity we cannot report here. Students had already treated the Maxwell's equations with their curricular teacher, for this reason we could give a pre-test with questions about the electric and the magnetic fields and the concepts of flux and circulation of a vector field.

In the following, we present some of our results: for each topic, besides the results of the written tests, we also show some excerpts from oral interviews that have been made before the sequence on the vector potential.

Electric and magnetic fields

Excerpts from oral interviews. (T stands for teacher, S stands for student)

T: *What generates a magnetic field?*

S₁: A charge?

T: *Is there a magnetic field in this room?*

S₁: I don't know...

T: *What could you do to answer?*

S₁: I don't know...

T: *If you consider a circuit with a LED connected to a battery, which are the fields involved in this case?*

S₂: If there is a circuit, then there will be a magnetic field, but if the wire of the circuit is insulated by some rubber, the magnetic field doesn't go outside... otherwise our houses would be filled with magnetic fields.

Question 1 proposed in the written tests:

"You have a very long wire carrying a direct current. Describe the fields present inside and outside the wire"

Results are summarized in Tab.1 for what concerns the electric field and in Tab.2 for what concerns the magnetic one.

Table 1. Categorization of students' conception about the electric field (from the answers to Question 1) with the percentage of students belonging to each category, pre-test and post-test.

Categorization about the electric field E	PRE	POST
An electric field is present inside the wire	28%	43%
No electric field is present outside the wire	0%	6%
Percentage of students answering the question	64%	91%

Table 2. Categorization of students' conception about the magnetic field (from the answers to Question 1) with the percentage of students belonging to each category, pre-test and post-test.

Categorization about the magnetic field B	PRE	POST
There are circular magnetic field lines around the wire	38%	93%
A magnetic field is present inside the wire	0%	0%
Percentage of students answering the question	64%	91%

Tab.1 points out a very common misconception in the pre-test: all students believed that no electric field is present outside a current carrying wire [Jefimenko, 1962]. Moreover only 72% of them retained it is not present even inside the wire. These ideas are probably due to the fact that, in teaching, electric fields are presented almost in connection with electrostatic, while in dealing with circuits, the most important concept involved is that of the potential difference.

From Tab.2 a similar (but reversed) situation emerges about the magnetic field: in the pre-test no one think it is present inside the wire and only 38% knows that it encloses the wire itself. Oral interviews also show great difficulties in describing electric and magnetic field in common situations.

Results coming from the post-test show that the experimentation on the vector potential has somewhat sorted out students' ideas only about the electric field inside the wire and the magnetic field outside the wire. A possible reason could be the brevity of the sequence on the vector potential that lasted only 5 hours while, probably, students needed much more time.

Flux of a vector field

Excerpts from oral interviews.

T: *What surface can I refer to when I want to determine the flux of a river?*

S: To the surface of the river... that is... to its higher part...

T: *So, is that surface a part of the river?*

S: Yes, it is!

T: *And what do you imagine when I say "the water flows THROUGH a surface?"*

S: I imagine some water moving on the surface, in a lot of different directions.

Question 2 proposed in the written tests:

"You have a uniform vector field \mathbf{v} and two different open circular surfaces of area S , as represented in the following figure (a). In (b) the surface is inclined by 30° respect to the horizontal. Find the flux of the vector field \mathbf{v} through the surfaces."

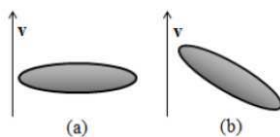

Results are summarized in Tab.3 for what concerns the flux through the surface (a), and in Tab.4 for what concerns the flux through the surface (b).

Table 3. Categorization of students' ability in calculating fluxes (from the answers to Question 2(a)) with the percentage of students belonging to each category, pre-test and post-test.

Categorization about the flux in case (a)	PRE	POST
$\Phi(\mathbf{v}) = BS$	57%	90%
$\Phi(\mathbf{v}) = BS \cos(90^\circ)$	36%	5%

Table 4. Categorization of students' ability in calculating fluxes (from the answers to Question 2(b)) with the percentage of students belonging to each category, pre-test and post-test.

Categorization about the flux in case (b)	PRE	POST
$\Phi(\mathbf{v}) = BS \cos(30^\circ)$	71%	71%
$\Phi(\mathbf{v}) = BS \cos(60^\circ)$	24%	16%

It might be interesting to observe that, as reported in Tab.3 and Tab.4, in answering the questions all students always wrote \mathbf{B} instead of \mathbf{v} for the vector field, even though in the text and in the picture they can always read \mathbf{v} . This is likely due to the fact that they were used to calculate only fluxes of the magnetic field

We can also observe that, after the sequence, students took more care in dealing with the flux of a uniform field.

The circulation of a vector field

Excerpts from oral interviews.

T: *For homework you were asked to recall the definition of circulation of a vector field? Did you do it, did look for the definition of circulation of a vector field?*

S₁: The Maxwell's equation?

T: *I think that maybe you are confusing a definition with a theorem involving the circulation...*

T: *What is the meaning of performing the circulation integral?*

S₂: ...the evaluation of an area...

S₃: Please, would you explain again what the circulation is?

Question 3 proposed in the written tests:

"You have a uniform vector field \mathbf{v} and two different closed square paths of side L . In (b) the square is rotated of 45° as represented in the picture. Find the circulation of the vector field \mathbf{v} along the two paths."

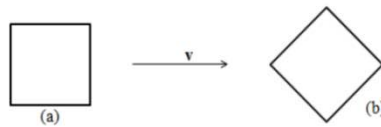

Results are summarized in Tab.5 for what concerns the circulation along the path (a) and in Tab.6 for what concerns the circulation along the path (b).

Table 5. Categorization of students' ability in calculating circulations (from the answers to Question 3(a)) with the percentage of students belonging to each category, pre-test and post-test.

Categorization about the circulation in case (a)	PRE	POST
$C(\mathbf{v}) = 0$	0%	76%
Percentage of students answering the question	19%	81%

Table 6. Categorization of students' ability in calculating fluxes (from the answers to Question 3(b)) with the percentage of students belonging to each category, pre-test and post-test.

Categorization about the circulation in case (b)	PRE	POST
$C(\mathbf{v}) = 0$	0%	76%
Percentage of students answering the question	33%	76%

Although Maxwell's equations had been presented to students in their integral form, therefore making abundant use the concept of circulation, students were not at all comfortable with this concept. At first, the use of circulation caused some discouragement in students but, as they realized that it is strictly related to conservative forces and work, they were stimulated enough to participate in class reasoning. For example, students found it very interesting reviewing the old and nearly forgotten physical quantity work as a line integral (they had never before defined work in such a complicated mathematical and way). Therefore, the percentage of students answering the questions in the post-test was incredibly enhanced. Besides previous ones, we proposed also another question on circulation, as reported below.

Question 4 proposed in the written tests:

“You have a situation very similar to that of Question 2, except for the different vector field: in this case the field changes verse in correspondence of the dashed line as, reported in figure.”

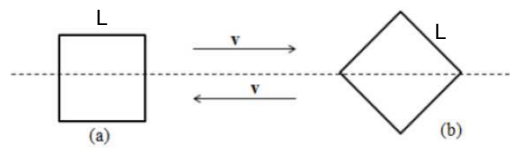

Results are summarized in Tab.7 for what concerns the calculation of circulation along the path (a) and in Tab.8 for what concerns its calculation along the path (b).

Table 7. Categorization of students' ability in calculating circulations with the percentage of students belonging to each category, pre-test and post-test.

Categorization about the circulation in case (a)	PRE	POST
$C(\mathbf{v}) = 2Lv$	0%	38%
Students that answer	14%	57%

Table 8. Categorization of students' ability in calculating circulations (from the answers to Question 4(b)) with the percentage of students belonging to each category, pre-test and post-test.

Categorization about the circulation in case (b)	PRE	POST
$C(\mathbf{v}) = 2\sqrt{2}Lv$	0%	38%
Students that answers	24%	57%

From Tab.7 and Tab.8 we can notice an improvement in the number of answering students, in their capabilities in facing the new concept of circulation, and in doing calculations.

3. Reflections for teachers: the importance of the vector potential

Since this section is devoted to teachers, we feel free to use differential operators (curl and divergence) instead of only integral operators (flux and circulation) as we did in the previous sections. Our aim is to highlight some features of electromagnetism and add reasons to the claimed importance of vector potential in secondary school physics teaching [see also Barbieri et al., 2013].

Maxwell equations in terms of potentials

With standard symbols, Maxwell's equations in terms of the fields can be written as:

$$\begin{aligned}\nabla \cdot \mathbf{E} &= \frac{\rho}{\epsilon_0} \\ \nabla \times \mathbf{B} &= \mu_0 \mathbf{J} + \epsilon_0 \mu_0 \frac{\partial \mathbf{E}}{\partial t} \\ \nabla \cdot \mathbf{B} &= 0 \\ \nabla \times \mathbf{E} &= -\frac{\partial \mathbf{B}}{\partial t}.\end{aligned}\tag{1}$$

Now:

$$\nabla \cdot \mathbf{B} = 0 \Rightarrow \exists \mathbf{A} \mid \mathbf{B} = \nabla \times \mathbf{A},\tag{2}$$

we call \mathbf{A} the magnetic vector potential. We observe that it is implicitly defined by a simply vector property. Substituting eq.(2) into the last of eq.(1) we get:

$$\nabla \times \mathbf{E} = -\frac{\partial}{\partial t} (\nabla \times \mathbf{A}) \Rightarrow \nabla \times \left(\mathbf{E} + \frac{\partial \mathbf{A}}{\partial t} \right) = 0 \Rightarrow \exists \phi \mid \mathbf{E} + \frac{\partial \mathbf{A}}{\partial t} = -\nabla \phi.\tag{3}$$

We call ϕ the electric scalar potential (also ϕ is then implicitly defined by a simple vector property). In terms of the scalar and the vector potentials the first two of eq.(1) (those containing the sources) after some simple calculations become:

$$\begin{aligned}\frac{1}{c^2} \frac{\partial^2 \phi}{\partial t^2} - \nabla^2 \phi &= \frac{\rho}{\epsilon_0} \\ \frac{1}{c^2} \frac{\partial^2 \mathbf{A}}{\partial t^2} - \nabla^2 \mathbf{A} &= \mu_0 \mathbf{J},\end{aligned}\quad (4)$$

where the Lorenz gauge condition:

$$\nabla \cdot \mathbf{A} + \epsilon_0 \mu_0 \frac{\partial \phi}{\partial t} = 0 \quad (5)$$

has been imposed. So, when written in terms of the potentials \mathbf{A} and ϕ with the condition (5), the Maxwell's equations are decoupled and have exactly the same mathematical form. Therefore, also their solutions will have the same form. In particular:

$$\phi(\mathbf{r}, t) = \frac{1}{4\pi\epsilon_0} \int_{V'} \frac{\rho(\mathbf{r}', t') dV'}{|\mathbf{r} - \mathbf{r}'|}, \quad (6)$$

that can also be seen as a definition of the electric scalar potential (especially at high school where it is generally given in a slightly more simplified version) and:

$$\mathbf{A}(\mathbf{r}, t) = \frac{\mu_0}{4\pi} \int_{V'} \frac{\mathbf{J}(\mathbf{r}', t') dV'}{|\mathbf{r} - \mathbf{r}'|}. \quad (7)$$

Equations (4), (5), (6) and (7) put clearly in evidence that the charge density ρ and current density \mathbf{J} are the sources both of the fields and of the potentials.

Magnetic vector potential for high school students

Looking at the Maxwell's equations in terms of potentials, it clearly appears that the two potentials have the same importance and play a similar role in electromagnetism; therefore we can safely say that the asymmetry in the didactical consideration of \mathbf{A} and ϕ has no physical reasons. We could also, jokingly, say that disregarding the vector potential is equivalent to choose to present only "one half" of the electromagnetism, *a priori*.

Evidently, differential operators are not suited for secondary school students, but this mathematical problem can be overcome [Barbieri et al., 2013]. In this work we can't linger on this point but, during our experimentations with secondary school students, we have effectively introduced the vector potential in close formal analogy with the scalar potential, by means of a simplified version of eq.(7), in the case of slowly varying vector fields [Barbieri et al., 2014].

Nonetheless, in the following will give some hints for the introduction of the vector potential by means of mathematical tools suited for upper secondary school students.

The two key points of the presentation for students are (a) the definition of the magnetic vector potential and (b) a property to allow students the determination of the vector potential in simple physical situations (similar to those for the determination of the magnetic field).

For what concerns the point (a) we give a definition of the vector potential in analogy with the definition of the scalar potential usually known to students. This approach is useful also for a better understanding of the definition of scalar potential.

In general secondary school students define the electric scalar potential for a discrete (and finite) distribution of charges. Therefore, indicating the scalar potential by ϕ , and the N charges considered by Q_1 , Q_2 and Q_N , with obvious meaning of the symbols, students write:

$$\phi(\mathbf{r}) = \frac{1}{4\pi\epsilon_0} \left(\frac{Q_1}{|\mathbf{r}_1 - \mathbf{r}|} + \frac{Q_2}{|\mathbf{r}_2 - \mathbf{r}|} + \dots + \frac{Q_N}{|\mathbf{r}_N - \mathbf{r}|} \right). \quad (8)$$

With the aim of introducing the vector potential, first students will generalize the definition (8) in the case of continuous distributions of electric charges, and then, they will write an expression for the vector potential in formal analogy with that of the scalar potential. The conceptual difficulty is that students have to recognize

that the electric currents are the sources of the vector potential as well as the electric charges are the sources of the scalar potential. This is an important point, that should be deeply discussed with students. Once this part is carried out, it is possible to write the definition of vector potential:

$$\mathbf{A}(\mathbf{r}) = \frac{\mu_0}{4\pi} \left(\frac{i_1 \Delta L_1}{|\mathbf{r}_1 - \mathbf{r}|} + \frac{i_2 \Delta L_2}{|\mathbf{r}_2 - \mathbf{r}|} + \dots + \frac{i_N \Delta L_N}{|\mathbf{r}_N - \mathbf{r}|} \right). \quad (9)$$

Actually, recalling eq. (7) we immediately see that the “formal” mathematical analogy has a precise physical justification, and it can be encouraging for teachers that would deal with this topic with their students.

By means of eq. (9) students may have an explicit definition of vector potential (that is a definition in the form $\mathbf{A} = \dots$, that appears very comfortable compared with $\mathbf{B} = \nabla \times \mathbf{A}$, in which the vector potential is implicitly defined). Moreover, eq. (9) gives an empirical referent that allows students to have a picture of the vector potential, in fact they can guess the behaviour of the vector potential by the behaviour of the currents, at least for the easier current distributions. The definition (9) of vector potential is instead useless in order to determine the mathematical expression of the vector potential, given the expression of the current distributions. It is for this reason that we developed the second key point (b) of the students’ presentation of the vector potential.

Let us imagine to have a magnetic field \mathbf{B} , in a certain region of space, a closed path γ , and two surfaces S_1 and S_2 that have γ as a boundary. S_1 and S_2 are such that the surface $S = S_1 \cup S_2$ is a closed surface. From the solenoidality of the magnetic field, we have that the flux of \mathbf{B} through the closed surface S is zero, that is:

$$\Phi_S(\mathbf{B}) = 0 \quad (10)$$

If then, we choose the normal vectors to the surfaces in such a way to give the same orientation for S_1 and S_2 with respect to the orientation of γ , we can rewrite eq.(10) as:

$$\Phi_{S_1}(\mathbf{B}) = \Phi_{S_2}(\mathbf{B}) \quad (11)$$

But S_1 and S_2 are two surfaces arbitrarily chosen. Therefore, following an argumentation used by Maxwell in his treatise, it must be possible to determine the flux of the magnetic field through an open surface, that has γ as a boundary, by a process that involves only the closed path γ and that does not involve the surface itself (in fact, the flux of the magnetic field through a surface bounded by a closed line cannot depend on the surface, that can be varied in infinite ways, but can depend only on its boundary). At this point Maxwell introduces a vector \mathbf{A} (the vector potential), a vector whose circulation along the closed path γ could provide the flux of the magnetic field through the open surface S that has γ as a boundary. In formulas:

$$\int_{\gamma} \mathbf{A} \cdot d\mathbf{l} = \int_S \mathbf{B} \cdot d\mathbf{a} \quad (12)$$

with $d\mathbf{l}$ the oriented element of the closed line γ and $d\mathbf{a}$ the oriented element of the surface S . It is possible to rewrite eq.(12) in a more concise formula:

$$C_{\gamma}(\mathbf{A}) = \Phi_S(\mathbf{B}) \quad (13)$$

Eq.(13) can be seen as another definition for the vector potential. It is possible to demonstrate that if the fields involved are slowly varying on time, the two definitions are equivalent. The theorem is beyond the level of a secondary school, but it can be stated to students without demonstration, thus allowing them to have a framework coherent and complete of the problem.

For students, instead, eq.(13) can be very useful to determine the vector potential in some simple cases of current distributions or for some simple magnetic fields. The property of eq.(13) gives a relation between the vector potential \mathbf{A} and the magnetic field \mathbf{B} , therefore it follows that if the problem gives a distribution of currents, the solution will pass from an initial determination of the magnetic field generated by the particular current distribution given. Many examples can be found in [Barbieri et al., 2014].

We would also like to stress that one of the most common obstacles to the introduction of the vector potential is the claim that it has no physical meaning. But this claim is false. In fact, it is worth noticing that the usual physical meaning given to the scalar potential (that is the energy needed to transport a charge from the infinity to a certain point, divided by the charge itself) holds only for a quasi-static electric field, and not in general. The same is true for the magnetic vector potential that, for a slow varying magnetic field, can be given the meaning of momentum per unit charge [Giuliani, 2010] and [Barbieri et al., 2013].

Relativity as the natural context for electromagnetism

Let us to return again to eq.(4). The identical mathematical structure of the two equations invite us to define two new four-vectors, the four-potential A_μ and the four-current J_μ as follows:

$$\begin{aligned} A_\mu &= (\phi, A_x, A_y, A_z) \\ J_\mu &= \left(\frac{\rho}{\epsilon_0}, J_x, J_y, J_z \right). \end{aligned} \quad (14)$$

The two equations (2) can now be combined into just one covariant equation:

$$\frac{1}{c^2} \frac{\partial^2 A_\mu}{\partial t^2} - \nabla^2 A_\mu = J_\mu. \quad (15)$$

This kind of formalism is certainly not suitable for students. But it is just an example of the deep connections between electromagnetism and special relativity. Our opinion is that teachers should more deeply link electromagnetism with relativity and we believe that the magnetic vector potential could be used to trigger off students' interest and help them in founding out those connections.

Here below, another example (immediately suitable for students) to show that in electromagnetism Galilean relativity is not enough, even at low velocities.

Let us consider a direct current carrying wire (A) and a beam of negative charges (B) having the same velocity of the negative current carriers in the wire, as represented in Fig.1.

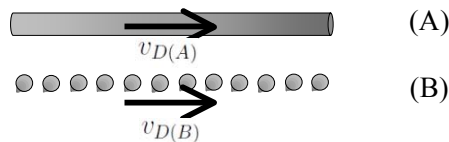

Figure 1. Hypothetical experimental situation: a current carrying wire (A) and a beam of charges (B).

In the rest frame of the wire (A), we have two parallel currents with the same verse and therefore, due to magnetic interaction, an attracting force will appear between the wire and the charges. Instead, in the rest frame of the beam of charges (B) we see only one current, the one given by the motion of the positive charges of the crystal lattice of the wire that is moving with the velocity $-v_D(A)$ (see Fig.1). In this frame of reference there won't appear forces: no electric forces, because the wire is neutral, and no magnetic forces, because there are no charges moving in the magnetic field generated by the moving positive charges of the lattice (A). We thus have two inertial frames describing a completely different physics. This is a contradiction that cannot be overcome in the Galilean relativity context [Chinnici, 2013].

We suggest teachers to present many other examples of this kind, in order to describe to their students why something beyond Galilean relativity is needed to treat electromagnetism, even avoiding the formalism of special relativity that may appear too complicated in some cases.

The problem of the gauge invariance

A very interesting and important question is given by the gauge fixing. In fact, for obtaining eq.(4) we made a particular gauge choice: the Lorenz gauge, given by eq.(5) [Barbieri et al., 2013]. Other choices are obviously possible; they give rise to different \mathbf{A} and ϕ fields, for given \mathbf{E} and \mathbf{B} , and to more complicated equations, different from eq.(4). For the existence of these possibilities, we found that students can be easily induced to think that the vector potential is not a well-defined physical quantity, or that it is quite a weird

mathematical tool lacking of a real physical meaning. The problems that come from the gauge invariance of electromagnetism and its connections with the physical meaning of potentials are really delicate, and particular care must be taken not to confuse secondary school students. But this is an opportunity, since some reflections on the physical meaning of the vector potential can also stimulate important reflections on the concept of physical quantities in general.

Our efforts are markedly focused in giving students the opportunity of reflecting on these aspects starting from a reversed point of view. For this reason, in our secondary school path (in the slowly varying field approximation) the vector potential is *defined* by eq.(7), thus it is univocally given by the current distribution. Instead, the integral property, stated for the first time by Maxwell [Maxwell, 1873] in order to define the magnetic vector potential, that links the vector potential \mathbf{A} to the magnetic field \mathbf{B} :

$$\int_L \mathbf{A} \cdot d\mathbf{l} = \int_S \mathbf{B} \cdot \mathbf{n} da, \quad (16)$$

where L is the boundary of the open surface S , is just a theorem, useful to *calculate* vector potentials from a given magnetic field. Therefore, it is very instructive to calculate the vector potential using eq.(16) starting from simple given magnetic fields, but it is precisely from the use of eq.(16) that students may experience the problem of the gauge fixing. An example can clarify what we are saying.

Let us consider a uniform magnetic field [Barbieri et al., 2013]. If students are asked to find out the field \mathbf{A} , they can easily see that the particular choice of the closed path L breaks the spatial symmetry of the uniform magnetic field and determines the particular “shape” of the vector potential. Since the symmetry may be broken in infinite ways, one can get infinite different vector potentials from a given magnetic field \mathbf{B} . But, at this point, students can return to the definition of \mathbf{A} given by eq.(7): in fact, they know that the vector potential is univocally determined by the currents. This is a very important step for the comprehension since it is possible to understand that the different \mathbf{A} s (given by the different ways in which the symmetry can be broken, and arising from the different chosen L s) are related to the different current distributions that can generate the same given magnetic field \mathbf{B} (in this case a uniform field).

The gauge freedom of the magnetic vector potential is only a particularly evident indication of an aspect that is common to many other physical quantities. Whilst only gauge-invariant quantities have physical meaning, nonetheless in our physical description we make use of many non-invariant fundamental quantities. For instance: position is univocally defined only relatively to a fixed reference frame; kinetic energy is defined only once the velocity is defined, that again depends on the reference frame; and the potential energy is univocally defined when not only a reference frame has been chosen, but when also the zero point of the potential has been fixed. These simple and well-known examples show that many physical quantities, although without possessing an absolute existence, as they strongly depend on some choices of ours, nonetheless maintain an important *relative* physical meaning; and no one could think to get rid of them.

4. Conclusions

Secondary school teachers could consider the vector potential too difficult an issue to be faced by their students. That idea usually comes out from the fact that the textbooks do not contain this topic and, in general, teachers themselves are not familiar with it.

On the contrary, we believe that the vector potential is of great help in secondary school physics teaching. In fact, the outcomes of our (only 5-hours lasting) experimentation on vector potential show that some deep difficulties with basic concepts of electromagnetism, such as those of circulation and flux and some understanding of the notions of electric and magnetic fields have, at least partially, been overcome. Moreover we believe that magnetic vector potential can be a great stimulus in order to reflect, solve problems and shed light on electromagnetism. Also many different branches of modern physics, i.e. superconductivity [Barbieri et al., 2014], may be more simply faced using the vector potential. Moreover, the vector potential provides a direct way to connect electromagnetism with special relativity and to reflect about the meaning both of the physical quantities and physical laws, even at secondary school level.

References

Barbieri, S., Cavinato, M. and Giliberti M. (2013). An educational path for the magnetic vector potential and its physical implications, *European Journal of Physics*. **34**, 1209-1221.

- Barbieri, S. (2014). Superconductivity explained with the tools of the classical electromagnetism, *PHD thesis*, Corso di dottorato in “Storia e Didattica delle Matematiche della Fisica e della Chimica”, XXIV.
- Barbieri, S., Cavinato, M. and Giliberti M. (2013). Riscoprire il potenziale vettore nella scuola superiore, *Il Giornale di Fisica*. **LIV**(2), 111-128.
- Chinnici, G. (2013). *Horror absoluti*, Ti Pubblica, Vignate (Milano), 143, 144.
- Giuliani, G. (2010). Vector potential, electromagnetic induction and ‘physical meaning’, *European Journal of Physics*. **31**, 871-880.
- Jefimenko, O. D. (1962). Demonstration of the electric fields of current-carrying conductors. *American Journal of Physics*. **30**, 19-21.
- Maxwell, J. C. (1873). *A Treatise on Electricity and Magnetism*, Oxford Clarendon Press. Vol.II, 405.

Affiliation and address information

Sara R. Barbieri
Department of Physics
University of Milano
Via Celoria, 16
20133 Milano, Italy
e-mail: sararoberta.barbieri@unimi.it

Responsible Research and Innovation in Science Education: the IRRESISTIBLE Project

Eugenio Bertozzi¹, Claudio Fazio², Michele Antonio Floriano², Olivia Levrini¹, Roberta Maniaci², Barbara Pecori¹, Margherita Venturi¹, Jan Apotheker³

¹ *University of Bologna, Italy*

² *University of Palermo, Italy*

³ *University of Groeningen, The Netherlands*

Abstract

The EU funded IRRESISTIBLE-project (Project Coordinator: Jan Apotheker, University of Groningen, Netherlands) develop activities designed to foster the involvement of high school and elementary students and the public in Responsible Research and Innovation (RRI). In the project, awareness about RRI is raised in two ways: increasing content knowledge about research by bringing topics of cutting edge research into the program; fostering a discussion among the students on RRI issues about the topics that are introduced. Responsible Research and Innovation focuses on six key issues: Engagement, Gender equality, Science education, Ethics, including societal relevance and acceptability of research and innovation outcomes, Open access, Governance. The project combines formal and informal teaching to familiarize schoolchildren with science. Sixteen partners in ten countries are involved and coordinated by Science LinX. Each participants will establish a community of learners (CoL). The communities include school teachers together with university experts in the field of science communication and science centre staff. Each CoL will develop materials that the teachers will use at their own schools and students will develop an exhibit for a science centre in their own country.

Once they have completed their teaching module, the teachers will each train five colleagues, in using the developed modules from the first year. Ultimately, this project will train almost ten thousand pupils to consider the social impact of scientific research.

Keywords

Responsible Research and Innovation, Science Education

1. Responsible Research and Innovation

Since 2010 the focus of the Science in Society framework of the EU has been the development of a framework for Responsible Research and Innovation (RRI). Responsible Research and Innovation asks for a close cooperation between society and research (Rome Declaration, 2014; Contribution of FP6 and FP7 to RRI; 2014). One of the first requirements for such a framework is the contact between the different stakeholders. In the project IRRESISTIBLE we raise the awareness about the relation between research and society among young people with a special focus on school students and their teachers as intermediates. For the purpose of the project the 6 aspects of RRI shown in table 1 have been considered and will be addressed throughout the project activities.

Table 1. Aspects of RRI and the use in the project modules

Engagement	Joint participation of researchers, industry and civil society in the research and innovation process
Gender Equality	Unlocking the full potential of society
Science Education	Creative education to foster the future needs of society

Ethics	Including societal relevance and acceptability of research and innovation outcomes
Open access	Free, online access to the results of publicly funded research
Governance	The responsibility of policy makers to develop harmonious models for RRI

2. The IRRESISTIBLE project

The IRRESISTIBLE project designs activities that foster the involvement of students and the public in the process of responsible research and innovation. We raise awareness about RRI in two ways:

- Increasing content knowledge about research by bringing topics of cutting edge research into the program
- Fostering a discussion among the students about RRI issues about the topics that are introduced.

The chosen topics listed in table 2 are based on cutting edge science within the universities of the partners and are characterized by a high societal relevance. The chosen topics connect and overlap with topics normally covered in secondary school curricula. For every topic, a lead partner is given; however, they will be developed and implemented in different countries throughout the project.

Table 2. Lead partners for the chosen topics

Netherlands	Healthy ageing
Portugal	Genomics and oceanography
Germany	Oceanography and climate change
Finland	Climate change
Israel	Renewable energy sustainability
Romania	Solar energy and specific nanomaterial
Turkey	Nanoscience
Greece	Nanoscience applications
Italy	Nanotechnology
Poland	Nanotechnology (catalysis)

3. Enhancing teacher professional preparation

The main focus of the project IRRESISTIBLE is on teacher professional preparation. All partners have experience in both pre- and in-service teacher training. Through teacher preparation a longer lasting effect will be established than working only with different students year after year. Teachers who have used educational material successfully will be using this material in consecutive years.

In the teacher training process formal and informal learning environments will be connected.

Informal environments can be used in different ways in the educational process:

- Attract positive attention from students towards a subject;
- Introduce content knowledge in a different way;
- Allow discussion with stakeholders about RRI issues;

In the formal learning environment the teachers will adapt existing material into a new format in which

- students are motivated;
- interest from both boys and girls is promoted;
- students take responsibility for their own learning;
- topics are introduced that demonstrate the overlap between different fields of science.

4. 5E format expanded to 6E format

The 5 E method has different steps. In the first three (Engage, Explore, Explain) content knowledge is studied and learned. In the last two steps (Elaborate, Evaluate) the focus is on discussing the RRI issues regarding the topic studied.

Between these last two steps we have introduced an extra step, Exchange, involving the development of an exhibition by the students. Students devising and presenting an exhibition is a means of transforming science from product to process (Hawkey, 2001). During these exhibits' preparation, learners will ask questions, use logic and evidence in formulating and revising scientific explanations, recognizing and analysing alternative explanations, and communicate scientific arguments.

Through the construction and presentation of exhibits on Responsible Research and Innovation both teachers and students are introduced to a different type of science from the one that is usually presented in science classes. Most of the formal science education focuses on a conventional, noncontroversial, established and reliable science.

5. Community of Learners

For the teacher training IRRESISTIBLE will use Communities of Learners (CoL). Communities of Learners have proven to be a powerful means of training teachers (Loucks-Horsley, Stiles, Mundry, Love, & Hewson, 2010). Within the Community of Learners each group has a different role: teachers have expertise with working in the classroom; science educators have a large theoretical background about education; science centres have experience in informal learning activities; researchers are experts in cutting edge science research; and people from industry are aware of the way science is used in industry.

Our Communities of Learners include experts from the field of formal and informal education, both in research and practice. The first step will be to adapt existing material on teaching and learning about Responsible Research and Innovation for school and out-of-school learning environments.

Topics will be cutting edge research taking place in the local universities, and will be supported by the researchers that will be part of the Communities of Learners. Cutting-edge scientific and technological matters highlight a "borderline science", that is controversial, preliminary, uncertain and under debate.

The controversial dimension refers to "differences over the nature and content of the science such as the perception of risk, interpretation of empirical data and scientific theories, as well as the social impact of science and technology" (Levinson, 2003).

Apart from content knowledge about the research related to the local curriculum, focus will be on the Responsible Research and Innovation aspects that will be integrated in the adapted teaching modules in an IBSE approach.

Each teaching module will:

1. Introduce an everyday situation/ subject (in order to make the topic contextualized and relevant to students),
2. use an IBSE approach, advances to the observing, classifying, experimenting and explaining the phenomena and the properties that are relevant to the chosen application,
3. address the broader issues related to the application in question: societal and environmental implications, ethical issues, and other RRI aspects,
4. include instructions for teachers on how to use the module and utilize the platform (e.g. exemplary schedule for the course, suggestions for lesson plans...),
5. provide additional reading material on the topic in question, to be included in the textbooklike information source for teachers and students,
6. suggest how students can design exhibits that
 - a. present the chosen subject (the same one as in the teaching module),
 - b. highlight the phenomena and properties relevant to that application,
 - c. address the societal and environmental implications and related ethical issues.

Each Community of Learners will include 4 to 5 teachers, next to the researchers and experts of outof-

school learning. As indicated by Shulman, both experienced and novice teachers can participate fruitfully in these communities (Shulman & Sherin, 2004). After the professionalization in the first phase of the project, these teachers will in turn act as coach another Community of Learners with again 4 to 5 new teachers or partner schools to introduce the modules from the first round and coach these new teachers to use the modules in their own classrooms or teaching practise lessons. This phase will be designed according to the local education system and the common teacher training system in each of the partners. After the first two rounds, at least 25 teachers in the region of the partners will have used the materials and become familiar with using the informal learning setting of the partners' science centre, involving on average 1000 students after the first two years of the project in each country. In total the project will reach at least 40 teachers in the first year, around 250 in the second year and will involve about 1000 students in the first round and about 10000 students in the second round of the project.

Each partner will use the material from at least two other partners, so that the material will be thoroughly evaluated. In the third year a compilation of the modules will be edited and will be published as a pdf file through www.scientix.eu. This material will not only contain the student's material but also a teacher guide, based on the experience of the coache-teachers. Each partner will make lectures about the content knowledge concerning the cutting edge research available for teachers by publishing the materials on the web¹.

The Communities of Learners will use Inquiry Based Science Education techniques that have proven to be effective (Eisenkraft, 2003; Martin-Hansen, 2002) and will work on modules to be used in the classroom. The Communities will be using a 6E template as a shared way to introduce content knowledge about the chosen topic. The teachers and the other experts will learn how to use these techniques by fitting the existing material into the 6E and IBSE format. They will then use this material in the classroom, if necessary being coached by the local experts in formal education.

Modules will be adapted based on the experience in the classroom. These modules will then be used in the second round. As each partner will produce a module at the end of the first round, the teachers from round 2 can choose from 10 modules which module they would like to work with. The teachers from round 1 will act as coach and will introduce the teachers from round 2 into the format used for teaching. The science centres will use or adapt their exhibition to draw attention towards the role of the research studied for society. Such an exhibition is also meant to catch the attention of the general public, supported by different dissemination activities. For the students this may be a starting point for their enquiry RRI project. In the second part of the modules the science centres will play an important role in the RRI discussions.

6. Participants

In each country the university participants work in collaboration with a science centre.

In Table 3 the universities and their science centre partners are indicated.

Table 3. Universities and science centre partners

University of Groningen - ScienceLinX	Local coordinator : Jan Apotheker (Principal Investigator)
Weizmann Institute - The Clore Garden Centre	Local coordinator: Ron Blonder
IPN - Deutches Museum	Local coordinator: Ilka Parchmann
Bogazici University - Turkey Science Centres Foundation	Local coordinator: Sevil Akaygün
University of Lisbon - Pavilhão do Conhecimento	Local coordinator: Pedro Reis
University of Palermo - Museum of Bali	Local coordinator: Michele Antonio Floriano

¹ An example may be found on http://qtvideo.service.rug.nl/comvachem/itunes_deel_1-ryan.mov; http://qtvideo.service.rug.nl/comvachem/itunes_deel_2-ryan.mov

University of Jyväskylä - Natural History Museum of Central Finland	Local coordinator: Ilkka Ratinen
University of Bologna - Museum of Bali	Local coordinator: Margherita Venturi
University of Crete - Eugenides Foundation	Local coordinator: <u>Dimitris Stavrou</u>
Jagiellonian University - Jagiellonian University Museum Collegium Maius	Local coordinator: Iwona Maciejowska
Valahia University Targoviste - Prahova Natural Science Museum and History	Local coordinator: Gabriel Gorghiu
University of Helsinki - Natural History Museum of Central Finland	Local coordinator: <u>Antti Laherto</u>

7. Use of web 2.0 activities

Students are increasingly immersed in web 2.0 activities in their free time, but in school these possibilities usually are not part of classroom activities. IRRESISTIBLE-project wants to increase a meaningful use of the opportunities these new technologies offer by including it into the modules. By introducing the teachers in the use of the new technologies the project aims for a wide spread use of 2.0 activities significantly beyond the module context.

8. Evaluation

Evaluation in the IRRESISTIBLE project includes three equally important aspects. The first part of evaluation analyses the work carried out within the Communities of Learners (COL) and the impact of the teacher professional development programme throughout Europe, both through pre- and in-service teacher education.

The second part of IRRESISTIBLE evaluation focuses on the modules developed in the COL's and implemented in schools. Here, the most important method is the measurement of the impact of the modules on students' and teachers' attitudes to Responsible Research and Innovation (RRI). Gender issues and other possible group differences will be investigated, related to factors and topics identified as important in former research. The third part of evaluation is the internal evaluation of the project itself: the organisation of the project as well as the communication and collaboration between the partners during the project.

Six types of evaluation tools are included in the project: a) an on-line questionnaire addressed to all the CoL members on general aspects of concern, IBSE methodology, exhibit design, social aspects of science education; b) an on-line questionnaire addressed to all the CoL members on RRI aspects; c) a checklist focused on the criteria for the modules addressed to one representative for each partner of the project; d) an on-line questionnaire addressed to students on RRI, exhibit design, social aspects of science education; e) case studies on exhibit development addressed to teachers (interviews) and students (focus-groups); project evaluation questionnaire addressed to one representative for each partner.

9. Responsible Research and Innovation in Nanoscience and Nanotechnology²

Nanotechnology is a word developed in the scientific literature, now frequently used also in common language. It is a word that stirs up enthusiasm and fear since nanotechnology is expected, for the good and for the bad, to have a strong influence on the future of mankind. To this end, considering the impact of cutting-edge research in nanoscience, a strong conceptual understanding and well established awareness of nanoscience and nanotechnology need to be developed in the society.

Everybody seems to know what nanotechnology is, but even within the scientific community its meaning is not yet well established. The nature of the involved nano sized objects is just at the basis of the different approaches of physics and chemistry to nanotechnology. Physicists are mainly interested in nanoscale objects that are simple from a chemical viewpoint and do not exhibit any specific intrinsic function (atoms, clusters of atoms, small molecules). In these cases functions arise from ensembles of such objects (i.e. nanoparticles, nanostructured materials, nanoporous materials, nanopigments, nanotubes, nanoimprinting, quantum dots...). The development of this kind of nanotechnology has already led to many innovative applications, particularly in materials science, such as the materials used in photovoltaics, in the construction of LED, and the development of carbon nanotube-based materials employed in several fields.

Chemists focus their interest on nanoscale objects that have complex chemical composition, show peculiar properties, and perform specific functions. Each single nanoscale object is, therefore, capable of performing a function that is intrinsically connected to its chemical nature and structure. Nanoscale objects of this type behave as real devices and machines at the molecular level and are present in nature where perform a variety of functions, from the light-harvesting antennae of the photosynthetic systems to the linear and rotary motors that work in our body. In the last twenty years chemists have learned to construct artificial molecular devices and machines that are expected to be of great importance in several fields. For example, they will open new ways for storing, processing, and transferring information, develop new approaches to diagnosis and therapy in medicine, find new solutions for the energy and environment problems. In addition, for many people the 'buzz word', nanotechnology, brings comfort to daily life, by innovative products and applications such as self-cleaning textile, anti-bacterial coating, and cosmetics. The scientific and conceptual background of these daily applications of nanotechnology and its social and ethical impacts should be elaborated and incorporated into science education. Nanoscience is also very well suited to demonstrate how basic concepts in science are used in state of the art scientific research. The identification and discussion with students of this basic concepts is helpful to induce interest and curiosity because these concepts are dealt with in a more concrete and effective way. As a result, the study of science laws is more appealing while, at the same time, frontier research is more tangible. This is particularly true for chemistry research, which is currently central in very diversified science areas.

The module is based on the teaching/learning materials that have been developed by the Bologna, Bogazici, and Palermo partners, which involve in their CoLs both physicists and chemists who work in the research field of nanoscience and nanotechnology and have competences in science education, history of chemistry, and dissemination.

References

- Eisenkraft, A. (2003). Expanding the 5E model. *The Science Teacher*, **30**, 57-59
- Hawkey, R. (2001) Innovation, inspiration, interpretation: museums, science and learning, *Ways of Knowing Journal*, **1(1)**, 23-31
- Levinson, R. (2003). Towards a theoretical framework for teaching controversial socio-scientific issues. *IJSE*, **28(10)**, 1201–1224.
- Loucks-Horsley, S., Stiles, K. E., Mundry, S., Love, N., & Hewson, P. W. (2010). Strategies for professional learning in *Designing professional development for teachers of science and mathematics* (pp. 157-278). California: Corwin.
- Martin-Hansen, L. (2002). Defining inquiry: Exploring the many types of inquiry in the science classroom. *The Science Teacher*, **59**, 34-37.
- Rome Declaration on Responsible Research and Innovation in Europe (2014). *Document-conference of the Science, Innovation and Society: achieving Responsible Research and Innovation (SIS-RRI)* held in Rome on 19-21 November 2014.
- Shulman, L. S., & Sherin, M. G. (2004). Fostering communities of teachers as learners: Disciplinary perspectives. *Journal of Curriculum Studies*, **33(2)**, 135-140.
- [The Contribution of Science and Society \(FP6\) and Science in Society \(FP7\) to a Responsible Research and Innovation \(2014\)](#) stocktaking by the Local Scientific Committee of the SIS - RRI Conference.

Affiliation and address information

Eugenio Bertozzi
Department of Physics and Astronomy
Alma Mater Studiorum – University of Bologna
Viale Berti Pichat 6/2
40127 Bologna, Italy
e-mail: eugenio.bertozzi2@unibo.it

Workshop: Tips and Tricks to Make Traditional Laboratory more Minds-on and Inquiry

Ed van den Berg

Free University Amsterdam and Hogeschool van Amsterdam, Amsterdam, Netherlands

Abstract

Research has shown that the objectives for laboratory teaching –just as with other teaching methods– are often not achieved and that many laboratory sessions are ineffective and yet expensive in terms of student and teacher time and facilities. There are several reasons for this (Millar, 2010; Berg, 2013) but one reason is that instructions for lab activities often still are too prescriptive (cook book) and leave too little room for thinking and creativity of the students. The paper illustrates tips and tricks to improve laboratory instructions by using the very familiar example of the simple mathematical pendulum.

Keywords

laboratory activities, practical work, laboratory instructions, laboratory teaching, inquiry.

1. Preliminary remarks

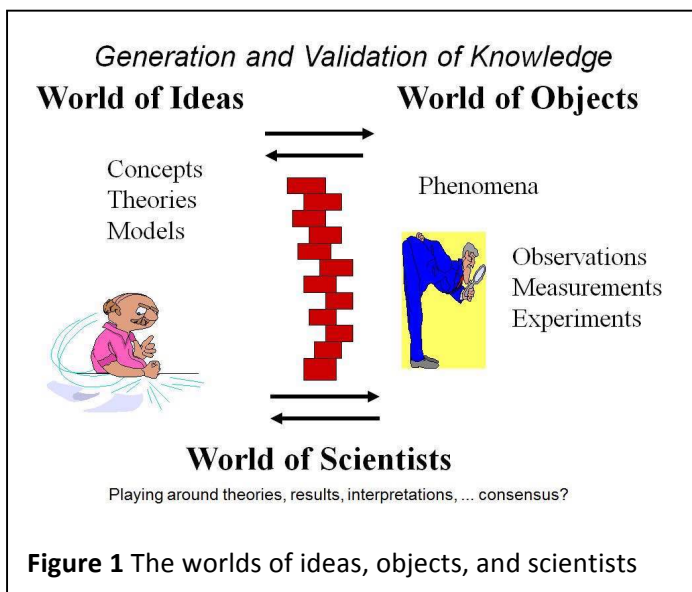

The essence of experimental science

At the frontiers of research, scientists continuously move back and forth between a world of theories, ideas, and concepts, and a world of objects (spontaneous phenomena) and laboratory experiments (contrived phenomena). *In the world of ideas* scientists generate new ideas, theories, and hypotheses. *In the world of objects* the ideas and hypotheses are tested. Then on the way back to the world of ideas, scientists try to make sense of their data using their concepts and theories and models. Research can also start with observations in the world of objects rather than the world of ideas, but even then the scientist is looking at the phenomena using his/her concepts and theories, even when he/she thinks to be 100% empirical. The phenomena and experiments serve as a source for *validating* ideas and theories and as a

playground for *generating* new ideas and theories in a complex mix of inductive and deductive mind play (Berg, 2013).

The essence of learning science in the laboratory

In student science laboratories students carry out experiments which are often intended as *either* an exercise in doing experimental research/inquiry, *or* support for understanding the theory discussed in lecture sessions, or an unclear combination of both. Both purposes require the student to make links between the world of ideas and the world of objects. However, frequently students only manipulate equipment and do not get to manipulating ideas (Gunstone, 1993; Millar, 2010). The conceptual or research goals of the laboratory get lost in the attention for equipment and there is no conceptual learning, nor learning of investigation skills. The art of laboratory teaching centres around the question of how to get students to make connections between the world of objects with the world of ideas, on *how to turn manipulation of equipment into manipulation of ideas*.

2. Research on teaching in the laboratory

Thirty-six years ago the first review of research on effectiveness of teaching in the laboratory (Bates, 1978) concluded that there was no evidence for better conceptual or process skill achievement for students WITH as compared to WITHOUT laboratory experience. Similar reviews followed (Hofstein & Lunetta, 1982, 2004; Lunetta et al, 2007; Hodson, 1993; Millar 2010) but were largely ignored until recently. For example, Abrahams and Reiss (2012, p1050) concluded after observing practical activities in 10 primary and 20 secondary schools in UK: *Indeed, what emerged from the comments made by both the primary and secondary students was that there was little evidence of any enduring conceptual understanding that could be clearly attributed to a specific practical task.* This sounds very much like what Reif and St. John (1979, p. 950) wrote about undergraduate physics laboratory lessons: *We found that most students cannot meaningfully summarize the important aspects of an experiment they have just completed. Usually they recall some of their manipulations in the laboratory, but are unable to articulate the central goal of the experiment, its underlying theory, or its basic methods. Thus, despite several hours spent working with the laboratory apparatus, many students seem to learn from this experience little of lasting value.* However, with modifications in the design of laboratory sessions Reif and St. John were able to get much better learning results in the laboratory. Laboratory can contribute to learning (Etkina, 2006; Goldberg et al, 2010), but in standard situations even trivial suggestions for improvement of effectiveness are not followed.

Apart from learning concepts, theories, and scientific models, we also want our science students to understand how knowledge is created and validated through research. We want them to learn to formulate research questions, to design experiments to answer these questions, and to do the necessary data analysis and interpretation. In other words, the students have to acquire inquiry skills and should eventually be able to apply them in authentic research projects. Such inquiry skills need to be practiced. So a first requirement is that inquiry skills are used regularly and across different science topics. Surprisingly an analysis of commonly used laboratory instructions shows that this is often not the case. Tamir and Lunetta (1981) discovered this when they analyzed the laboratory manuals of the well-known 1960s NSF sponsored Biology (BSCS), Chemistry (CBA, ChemStudy), and Physics (PSSC, Harvard Project Physics) textbooks in the USA in 1981. They concluded that:

Seldom, if ever, are students asked to:

- a. formulate a question to be investigated;*
- b. formulate an hypothesis to be tested;*
- c. predict experimental results;*
- d. work according to their own design;*
- e. formulate new questions based on the investigation; and*
- f. apply an experimental technique based on the investigation just performed."*

These textbooks were intended and advertised to be inquiry oriented. Germann et al. (1996) did a similar analysis for 9 Biology laboratory manuals with similar results; nothing had changed from 1981 until 1996. Abrahams and Millar (2008) observed 25 laboratory lessons of different teachers and at different schools in England and concluded that:

The teachers' focus in these lessons was predominantly on developing students' substantive scientific knowledge, rather than on developing understanding of scientific enquiry procedures. Practical work was generally effective in getting students to do what is intended with physical objects, but much less effective in getting them to use the intended scientific ideas to guide their actions and reflect upon the data they collect.

So it was this back-and-forth thinking between the two Worlds (figure 1) that was lacking. Abrahams and Reiss (2012) confirmed these results in a study of 20 other secondary schools in England where inquiry has been much emphasized in various national curricula (National Curriculum 1999, 2009). Yet it is relatively easy to convert traditional cookbook instructions into laboratory experiments which are a few steps closer to real inquiry. That is the subject of this paper.

3. Phases of research and laboratory lessons

Much research can be divided into three phases:

1. *A design phase* where a research question is asked, is narrowed down and then an experiment is designed to answer the question. **This phase requires thinking back-and-forth between a world of ideas (concepts, theories, models) and a world of observable objects and phenomena.** For example, asking a question and narrowing it down to a researchable question requires linking of observable phenomena with concepts.
2. *A data collection phase* in which the experiment is executed and data are collected.
3. *An analysis and interpretation phase* in which data are analyzed, interpreted, and conclusions are formulated and reported. **Also this phase requires the thinking back-and-forth between the world of ideas and the world of objects.** Analysis and interpretation requires a review of ideas/concepts in the light of the experimental evidence, that is observations and measurements.

Table 1. Laboratory Task Analysis Inventory (Tamir & Lunetta, 1981)

	Inquiry skill		Inquiry skill
1.0	DESIGN	3.0	ANALYSIS AND INTERPRETATION
	The student		The student
1.1	Formulates the research question	3.1	Transforms results in standard form (tables)
1.2	Formulates an hypothesis or expectation	3.2	Determines relationships (including graphs).
1.3	Designs the experiment (defines independent and dependent variables, etc.)	3.3	Describes/discusses precision of data
1.4	Designs observation and/or measurement procedures for each variable (operational definitions).	3.4	Describes or discusses assumptions
1.5	Predicts results	3.5	Formulates generalizations
		3.6	Explains relationships
2.0	DATA COLLECTION	3.7	Formulates new questions
2.1	Observes, measures		
2.2	Manipulates equipment	4.0	APPLICATIONS, FOLLOW-UP
2.3	Records results	4.1	Predicts based on results of the experiments
2.4	Computes	4.2	Formulates hypotheses for follow-up
2.5	Explains or decides about procedures	4.3	Applies the experimental technique to a new problem
2.6	Works according to own design		

A further specification of each phase with the typical skills involved can be found in table 1. The table specifies a fourth follow-up phase which we will not further discuss in this paper. Concrete examples of the inquiry skills will be given below. Not every school laboratory activity will cover all skills listed in table 1, not even each of the three phases. However, *in the course of a school year*, students should regularly experience each of the three phases and use each of the skills involved in different science topics. All together the laboratory and investigation activities of one school year should cover the three phases and the skills listed.

Phase 2, data collection, occurs in every lab activity. Phase 1, design, *seldom* occurs as instructions for the experiment are usually given and not designed by the student. However, thinking about the set-up of the experiment is essential to understand its purpose and to later generalize or not from its results. Is there no time in the lesson for phases 1 and 3? Time can be created by a) reducing the number of experiments in a course and b) including homework questions ahead of the laboratory lesson (*Think of an experiment to investigate, which concepts are involved, what are the main variables, which are you going to vary, which do you set, which do you measure, sketch the experimental set-up, etc.*).

To see which inquiry skills are involved in a certain laboratory activity one can look at every sentence in the lab instructions which requires a student to do or write something and then match it with the checklist of table 1. For example *build the set-up given in the diagram on the worksheet* would be 2.2 of the checklist. *Predict what will happen if* will be 1.5 if it is at the start of the experiment and 4.1 if it is after the experiment

as follow-up. This analysis was used by Tamir and Lunetta (1981) and later Germann et al (1996) to classify lab instructions and then they concluded that items 1.1 – 1.5 and 3.4 – 3.7 seldom appeared. Thus the back-and-forth thinking between the worlds of ideas and objects/phenomena is not demanded or stimulated by these laboratory instructions, and so the heart of experimental science is missing.

We will now give a concrete example of using table 1 in the common traditional pendulum experiment and then show how the experiment could easily be modified to give an opportunity to involve a wider spectrum of inquiry skills. Please note that the successful use of inquiry skills is closely connected to the subject matter involved (Millar, 2010). Students will need to practice the same skills in different topics in order to achieve some degree of transfer.

Following are student instructions for different versions of the well-known pendulum experiment often done in an introductory physics course in junior or senior high school.

4. Pendulum version I: Verification of the formula for the mathematical pendulum

A. The teacher shows the students an example of a pendulum and points to the two important variables: the length of the string (l) and the time it takes to make one complete swing (T).

B. The students receive the equipment for the experiment and the following instructions:

1. Measure the time needed for 10 complete swings ($10T$) for different values l (length) of the string and record the results in the table.
2. Compute $2\pi\sqrt{l/g}$ for each value of l , use $g = 9.81 \text{ m/s}^2$
3. Do the measured values of T match with the computed values?

Table 2. Pendulum version I

Length	$10T$	T	$T = 2\pi\sqrt{l/g}$
40 cm			
60 cm			
80 cm			
100 cm			
120 cm			
140 cm			

When we classify these lab instructions using the checklist in Table 1, we notice that skills 1.1 – 1.5 are not represented. Skills 2.1 – 2.4 are, but category 3 (3.1 – 3.7) is missing. Skill 3.1 involves tabulating data, but here the table is already provided, students only fill the table.

What will students learn from this lab exercise? They will learn to measure distance and time (if the teacher does check whether they properly handle ruler and stopwatch), they learn how to fill a given table, and they compute. Perhaps they also learn that measuring a longer time ($10T$) is more precise than measuring a shorter time (T), but will they realize *that this is only allowed when one is sure that T is not dependent on the amplitude?* Is this an interesting lab activity for students? Not really.

We now present three alternative versions.

5. Pendulum version II: Designing an experiment to “prove” a formula

Give the formula $T = 2\pi\sqrt{l/g}$ and ask students how you can provide experimental evidence for this formula. What should you measure, what should you vary, what should you keep constant and what will be your set-up? Design a table to record your measurements (Do **not** give table 2). One would expect that students in senior secondary school right away know what to do, that verification would be obvious. It turns out they do not and they may have great difficulty thinking of a proper design. This same verification method can be used with many other formulas in physics, for example with Ohms Law ($V/I = \text{constant}$), with the lens formula $\frac{1}{f} = \frac{1}{s_{\text{object}}} + \frac{1}{s_{\text{image}}}$. In my classes students right away have problems: What is the focal length f , how do you measure it for convex lenses without using the lens formula? What are the object distance (s_o) and image distance (s_i) in an actual experimental set-up rather than a textbook ray diagram and how do we measure these? Can students point out these variables in an experimental set-up with a lens? What are you going to vary and with which values? Should different lenses be used in a verification experiment or is one lens enough? This form of lab turns out to be very useful. Students have to make a

plan. That takes time, 10 minutes. Do they make a good plan? Some do, some don't. The teacher goes around to listen and check the plans. Once approved, students can do their own experiment. If students do not have a good plan in 10 minutes, the teacher can give them one. At least by then students have already thought about the experiment and will understand better what to do and what to think about. If students learn to make a design of an experiment in the form of a sketch and a data table, then the teacher can check very quickly what students plan to do. The instruction to make a plan can also be given as homework to make class time more efficient.

What do students learn from this version of the experiment? They get experience in linking concepts and variables to observable phenomena, they are forced to think of what a formula means in terms of the phenomena. They also get experience in planning an experiment where they systematically vary variables and decide how to measure them.

6. Pendulum version III: Inquiry

The objective of this version is to provide students experience with skills 1.1 – 1.5, but first there is a pre-lab exercise in handling the stopwatch in part A. The teacher briefly introduces the lab. (S)he has several pendulums in front of the class which all have different periods. The teacher makes them swing. They all swing with different periods. But for each pendulum, is this period constant? The first instruction to the students is as follows:

A. Find out whether the period of a particular pendulum is constant or not.

Comment: the main purpose of this task is to make students practice precise time measurement with a stopwatch. However, students also have to figure out how they can determine whether or not the period is constant. One way could be to measure $10T$ for the first 10 swings and then $10T$ for swing number 21 – 30, but we do not tell them this solution. So the skills exercised are 1.3/1.4 and 2.2. A more specific question would be to ask students whether they expect the period to change when the amplitude decreases. Many would expect a smaller period when the amplitude decreases, the fact that it turns out to be constant (for varying but small amplitudes) is surprising.

B. Plenary discussion of activity A: Is T really constant for a given pendulum? Is n't it strange that with decreasing amplitude T does not change? If we know that T is constant, how can we measure it more accurately?

C. Plenary discussion of activities D and E: Students found different values of T . What would T depend on? Students will mention all kinds of properties of a pendulum, length, mass, material, amplitude (as angle or as length?), shape of the bob, temperature, g , etc. Our experience is that students mention many variables even those students who have already memorized the formula for the mathematical pendulum.

D. Plenary: The teacher then instructs each student pair or group to choose a variable and design an experiment to investigate the influence of that variable on T .

E. Instructions for students:

1. Choose a variable. How do you think this variable will influence the period? Make a prediction and explain your reasons.
2. Design an experiment to test your prediction. Which variable(s) are you going to vary? Which variable(s) are you going to measure? How? How can you improve the accuracy of your results? Put your design in the form of a sketch and a data table and show it to the teacher for approval.
3. Carry out the experiment and report your measurements in an appropriate table.
4. What are your conclusions? Do they match your prediction? Why or why not?
5. Were your measurements accurate? Which factors might have negatively influenced the accuracy?
6. What would you do differently if you were to repeat the experiment?

Version III of the pendulum experiment has different objectives compared to version II. There is no best version, what is best depends on what the teaching objectives are and how well these are realized in the laboratory activity. Version III involves a wider range of inquiry skills. The preparation phase of research is emphasized such as choosing a variable, controlling variables, defining variables operationally so they can

be measured. How do you define amplitude, as an angle or as a length? What is the length of a pendulum, the length of the string, or of string + bob, or length until the center of mass of the bob? If the experiment is done without any analysis of the forces involved, it is not obvious that the latter is the better one. How do you define "shape" of the bob? In the analysis and interpretation phase students have to design their own table (3.1), draw their own conclusions (3.5) and report something about the accuracy of their results (3.3) and how it could be improved (going back to 1.3 and 1.4).

An important advantage of version III is that different groups of students work on different variables thus different experiments and that they do not know the results ahead of time. They cannot copy other groups or get book results.

Considering the objectives of version III, it is clear what the teacher has to do. While going around the classroom, the teacher questions the students about their choice and operationalization of variables, the design of their experiments, whether they control variables, how they measure, and how accurately. The questions of the teacher are directly related to the particular inquiry skills which are used.

Please note that Dvorakova (2014) published an interesting version of the pendulum experiment for grade 6 and 7 pupils focusing on frequency rather than on period.

7. Pendulum version IV: Fun alternatives

The simple pendulum is boring of course. An alternative is to hang all kinds of different pendulums in the classroom: a swing, a bifilar pendulum with weights which rotates to and fro, a rotating bucket with weights or sand or water which can be moved or taken out (figures 2 & 3), a swinging chair. With such pendulums it is much more exciting to find out experimentally which factors influence the period. Please note that in the lab activities described above students do this purely experimentally by systematically varying variables rather than through theoretical analysis. At a more advanced level, students could get involved in making/checking and testing theoretical models for the periods of different types of pendulums and verifying them in an iterative process. That is when the real process of back-and-forth thinking between worlds of ideas and objects can take place.

8. Classroom experiences

The various alternatives presented have been used by the author and colleagues in different countries and with different groups of students ranging from lower secondary to pre- and in-service teacher education programs. Versions II – IV have indeed succeeded in providing students with experiences in design of experiments (skills 1.1 – 1.5, 2.5, 2.6) and interpretation (3.1 – 3.7) and moving between concepts and phenomena and also in exposing their difficulties with this. Versions III and IV have stimulated a wide variety of creative and interesting experiments.

In short, by making small changes in the activities for a laboratory activity the teacher can make big changes in what students are exposed to and can potentially learn. The task of the teacher is to challenge the students to think back-and-forth between concepts and what they can see and measure. As could be seen in the quotes of Abrahams and Reiss (2012), this is not a trivial matter.



Figure 2: Rotation pendulum in the Philippines. Weights could be placed closer or farther from the center, strings could be



Figure 3: Indonesian teachers with a swing pendulum of which various properties can be manipulated.

lengthened/shortened, the basket could be changed.

References

- Abrahams, I. Millar, R. (2008). Does Practical Work Really Work? A study of the effectiveness of practical work as a teaching and learning method in school science. *International Journal of Science Education*, 30(14), 1945–1969.
- Abrahams, I., Reiss, M.J. (2012). Practical Work: Its effectiveness in Primary and Secondary Schools in England. *Journal of Research in Science Teaching*, 49(8), 1035-1055.
- Bates, G.R. (1978). The role of the laboratory in secondary school science programs. In: M.B. Rowe (Ed.): What research says to the science teacher (Vol I). Washington D.C.: National Science Teachers Association.
- Berg, E. van den (2013). The PCK of Laboratory Teaching: Turning Manipulation of Equipment into Manipulation of Ideas. *Scientia in Educatione*, 4(2), p 45–64. <http://www.scied.cz/Default.aspx?PorZobr=1&PolozkaID=134&ClanekID=362>
- Dvorakova, I. (2014). Active learning in the Heureka Project – teachers in the role of students. Proceedings 2013 ICPE Conferentie, Praag. <http://www.icpe2013.org/proceedings>
- Etkina, E., Murthy, S., Zou, X. (2006). Using introductory labs to engage students in experimental design. *American Journal of Physics*, 74(11), 979-986.
- Germann, P.J., Haskins, S., Auls, S. (1996). Analysis of nine high school Biology laboratory manuals: Promoting scientific inquiry. *Journal of Research in Science Teaching*, 33(5), 475-499.
- Getting Practical: <http://www.gettingpractical.org.uk/index.php>
- Goldberg, F., Otero, V., Robinson, S. (2010). Design principles for effective physics instruction: A case from physics and everyday thinking. *American Journal of Physics*, 78(12), 1265-1278.
- Gunstone, R. (1993). Can we prepare teachers to teach the way students learn? Plenary lecture at the International Conference on Science Education in Developing Countries: From Theory to Practice. Israel, January 1993.
- Hodson, D. (1993). Re-thinking old ways: Towards a more critical approach to practical work in school science. *Studies in Science Education*, 22, 85-142
- Hofstein, A., & Lunetta, V.N. (1982). The role of the laboratory in science teaching: Neglected aspects of research. *Review of Educational Research*, 52(2), 201-217.
- Hofstein, A., & Lunetta, V.N. (2004). The laboratory in science education: Foundations for the 21st century. *Science Education*, 88, 28-54. Millar, R. (2010). Analysing practical science activities to assess and improve their effectiveness. Association for Science Education.
- Lunetta, V.N., Hofstein, A., Clough, M.P. (2007). Learning and teaching in the school science laboratory: An analysis of research and practice. In Abell and Lederman (eds): Handbook of Research on Science Education. Mahwah (NJ), Lawrence Erlbaum Associates Publishers, 393-442.
- Millar, R. (2010). Practical work. In J. Osborne & J. Dillon: Good practice in science teaching, what research has to say (2nd edition). McGrawHill/Open University.
- National Curriculum (1999, 2009). National Curriculum for England and Wales. Qualifications and Curriculum Authority. <http://www.nationalstemcentre.org.uk/elibrary/resource/2910/science-in-the-national-curriculum-1999> and www.qcda.gov.uk/curriculum.
- Reif, F., & St. John, M. (1979). Teaching physicists' thinking skills in the laboratory. *American Journal of Physics*, 47(11), 950-957.
- Tamir, P., Lunetta, V.N. (1981): Inquiry-related tasks in high school science laboratory handbooks. *Science Education*, 65(5), 477-484.

Affiliation and address information

Ed van den Berg
 Free University Amsterdam and Hogeschool van Amsterdam,
 Amsterdam, Netherlands
 e-mail: e.berg@vu.nl

Appendix: Hand-out for analysis of laboratory activities.

N.B. I chose a very traditional but well-known experiment as that probably best communicates the purpose and method of analysis of lab activities.

Instruction: For each *action* of the students in this activity, find the proper codes from the Laboratory Task Analysis Inventory (Table 1) and write them in the left column. One action can have more than one code. Answers in red.

Table 3: Pendulum version I: Verification of formula for the mathematical pendulum

Codes	Lab instructions
	A. The teacher shows the students an example of a pendulum and points to the two important variables: the length of the string (l) and the time it takes to make one complete swing (T).
	B. The students receive the equipment for the experiment and the following instructions:
2.1, 2.2, 2.3	1. Measure the time needed for 10 complete swings ($10T$) for different values l (length) of the string and record the results in the table.
2.4	2. Compute $2\pi\sqrt{l/g}$ for each value of l , use $g = 9.81 \text{ m/s}^2$
3.2	3. Do the measured values of T match with the computed values?

Table 4: Pendulum version III: Inquiry

Codes	Instructions
1.4, 2.1, 2.2, 2.3	A. Find out whether the period of a particular pendulum is constant or not ¹ . a. Describe how you would do this. b. Do the measurements.
none	B. A plenary discussion on outcomes of task A follows. Is T really constant for a given pendulum? Isn't it strange that with decreasing amplitude T does not change? If we know that T is constant, how can we measure it precisely?
	C. Plenary discussion: Students found different values of T . What would T depend on? Students will mention all kinds of properties of a pendulum, length, mass, material, amplitude (as angle or as length?), shape of the bob, temperature, g , etc.
None see E1-6	D. Plenary: The teacher then instructs each student pair or group to choose a variable and then design an experiment to investigate the influence of that variable on T .
1.2	E. Instructions for students: 1. Choose a variable. How do you think this variable will influence the period? Make a prediction and explain your reasons.
1.3, 1.4, 3.3, 3.1	2. Design an experiment to test your prediction. a. Which variable(s) are you going to measure? How? b. How can you improve the precision of your results? c. Show your design by drawing the table in which you will record your data.
2.1, 2.2, 2.3, 2.6, 3.1	3. Carry out the experiment and report your measurements in a clear way (in a table).
3.2, 3.5	4. What are your conclusions? Do they match your prediction? Why or why not?

3.3	5. Were your measurements precise? Which factors might have negatively influenced the precision?
1.3, 1.4	6. If you were to repeat the experiment in a better way, what would you change?

Playing with (Super)Hydrophobicity: An Interdisciplinary Experimental Sequence on Physical Properties of Water.

Assunta Bonanno, Giacomo Bozzo, Federica Napoli, Peppino Sapia

Physics Education Research Group – University of Calabria – 87036 Rende CS - Italy.

Abstract

We present a series of experimental activities, based on super-hydrophobic toys, allowing high school students to get in touch with a class of phenomena, concerning water properties, which are very relevant in an interdisciplinary perspective. In particular, important topics (such as surface tension, hydrophobicity, wettability of a surface, self-aggregation) are usefully illustrated in an appealing context, making use of self-made devices. Furthermore, the use of commercial grade high-speed cameras, together with freely available software, allows teachers to improve proposed experiments, making them quantitative.

Keywords

Interdisciplinary learning, laboratorial activities, properties of water, video analysis.

1. Introduction

The increasing complexity and pervasiveness of technological applications of the empirical sciences more and more suggests the opportunity of finding significant moments of integration of the physics' teaching/learning process with that of other sciences, especially chemistry and biology. There is no doubt that, in such a context, physics preserves a peculiar epistemic status, as it provides to the other empirical sciences the key, both conceptual and instrumental, for the success of the reductionist approach often taken by these sciences. In this context, great importance is assumed by the identification of teaching topics, within the physics curriculum, that lend themselves well to the preparation of interdisciplinary learning paths allowing learners to grasp a unitary perception of science.

In this perspective, a very interesting argument is represented by the physical properties of water, in particular those concerning its interaction with a large class of surfaces known as “hydrophobic” surfaces. Hydrophobicity, in fact, is a kind of “emerging” force driving many important processes, either in the biological realm (let's think as an example to the self-aggregation of molecules giving rise to cells membranes) or in the development of technological applications (let's think to the development of water-repellent clothing).

In this work we describe a consistent series of activities, based on super-hydrophobic toys (and on cheap components easily obtainable by these toys), allowing high school students to get in touch with unusual phenomena concerning water properties, such as those related to: *i)* surface tension, *ii)* self-aggregation of macromolecules driven by hydrophobic/hydrophilic character, *iii)* wettability of a surface; just to cite some.

The experiments we propose can be carried out with simple teaching equipment and are well suited to undergraduate students. Moreover, some well-known toys (the “Aqua Drop” and the “Magic Sand” games) inspire our didactical activities, whose playful nature allows teachers to construct learning paths at different levels, ranging from undergraduate students to primary school pupils. On the other hand, the use of commercial grade photo/video cameras, together with freely available video analysis software, allows undergraduate learners to explore unfamiliar phenomena related to fluids, allowing them to get in touch with the principal theoretical concepts and practical applications pertaining a context located at the crossway among physics, chemistry and biology. Finally, the multimedia learning path aims to give students and teachers methodological and practical hints to independently conduct and analyse their own teaching experiments on such systems.

2. Hydrophobic, hydrophilic, amphiphilic: in brief

As regards the interaction with water, material surfaces show a wide spectrum of behaviours, ranging from those that are wetted by water easily and completely, to those that are not wetted by water at all. On the former surfaces, water spreads and flattens out forming a film, while on the latter, water collects into almost

spherical droplets to minimize the contact with them. This variety of behaviour is due to a physicochemical property of the material surface that we can define as the “affinity of the surface towards water”. The easiest method to make such a property a measurable physical quantity relies on the concept of “contact angle”, defined in Figure 1.

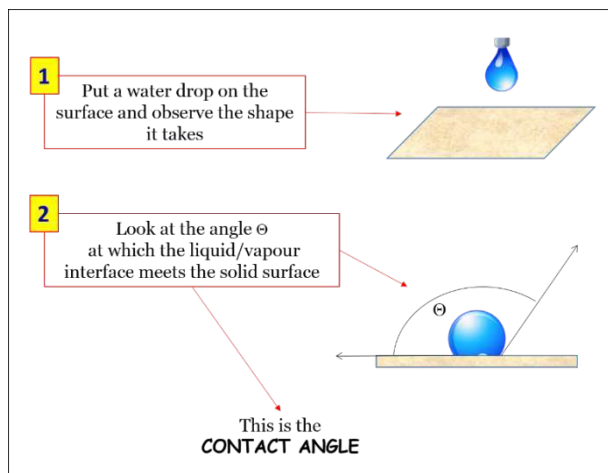

Figure 1. For a liquid drop setting on a solid surface, the contact angle is defined as the angle where the drop’s liquid/vapour interface meets the solid surface. Conventionally this angle is measured through the liquid.

Depending on the value of contact angle, surfaces are broadly classified as shown in Figure 2. In this perspective, the two terms “hydrophilic” (from the Greek “water-loving”) and “hydrophobic” (“water-hating”) are complementary aspects of a single property, i.e. the affinity of the surface towards water.

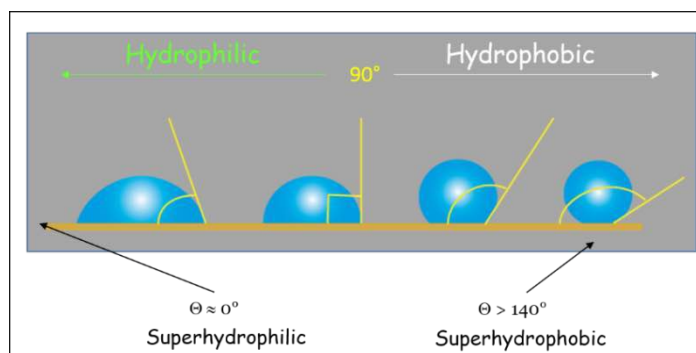

Figure 2. Classification of surfaces with respect to the contact angle

The whole spectrum of hydrophobicity/hydrophilicity can be encountered in everyday life surfaces. Figure 3 shows some examples: a microscope glass slide (labelled “normal glass” in the Figure) is markedly hydrophilic (contact angle around 20°); a 5 Euro-cents coin exhibits a borderline behaviour (about 90° contact angle); a “smoked glass” (i.e., a glass slide on which a film of soot was deposited by holding it over a burning candle) is super-hydrophobic, featuring a contact angle close to 160° (water drops in Figure 3 are blue since methylene blue dye has been added to improve drops visibility).

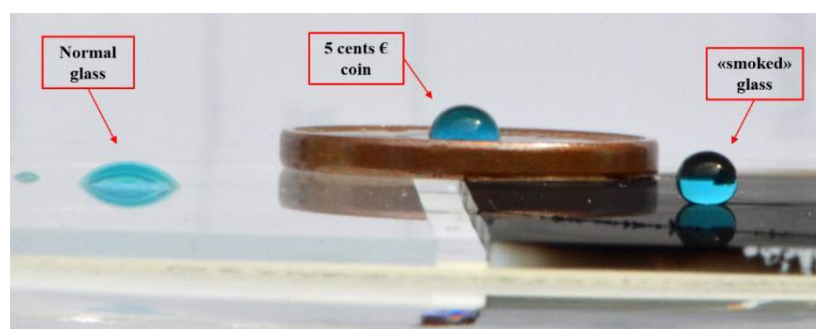

Figure 3. Examples of (coloured) water drops on surfaces exhibiting different affinity towards water.

So far, we spoke about hydrophobicity/hydrophilicity as a property exhibited by a *macroscopic surface* when interacting with water. It is important to underline that a quite similar variety of behaviour (as regards the affinity for water) is shown, on a completely different scale, by single molecules. Polar molecules (as, for example, NaCl, i.e. the common kitchen salt) have a great affinity for water, while non-polar molecules (typically water insoluble hydrocarbon chains, as for example the fatty acids composing the olive oil) have a much more reduced affinity for water. In other words, kitchen salt is hydrophilic, while olive oil is hydrophobic. Something more interesting happens when considering molecules exhibiting *both* characteristics, i.e. molecules having a localized hydrophilic portion and another portion that is hydrophobic. Such molecules are said to be *amphiphilic* (a term coming from Greek, essentially meaning “loving both”). Amphiphilic molecules in water solution give rise to auto aggregation phenomena (see, for example, figures and description in Sacristan 2014) which have an extremely relevant biological importance, including possible mechanisms for the beginning of life (SCQ 2004, and references therein). Auto aggregation of amphiphilic molecule is an “emergent property” (Huttermann and Terzidis, 2010) whose “driving force” is constituted by the tendency of the hydrophobic portion of molecules to be shielded against water.

3. Experiments based on super-hydrophobic toys

Physical properties recalled in the last section can be beautifully illustrated and explained in an educational context by using some well-known toys based on the super-hydrophobic effect.

The most significant of such toys is *Magic Sand* (Magic Sand, 2014). It consists of normal sand grains coated with a superhydrophobic compound. In this way, when put in water, grains self-aggregate in order to minimize surface area exposed to the polar solvent. Conversely, when the sand is removed from water, it is completely dry. This characteristic gives rise to a truly amazing behaviour able to elicit learners’ curiosity, which is a prerequisite for the discovery-based learning.

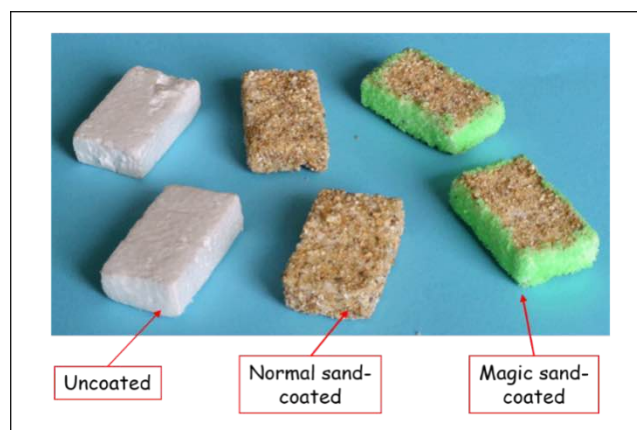

Figure 4. Polystyrene chunks (3x1.5x0.5 cm) for the self-assembly experiment.

Another useful toy in the aim of illustrating the particular behaviour of water when interacting with super-hydrophobic surface is the “Aqua Drop” (Shakerin 2011). It is a sort of “water pinball” in which the ball is constituted by a droplet freely sliding/rolling on a super-hydrophobic surface. Video analysis of water drops impinging on the Aqua Drop surface allows students to acquire confidence with the “elastic” behaviour of water drops. Consequently, such an activity (which we will briefly mention in the following) may be usefully included in any learning paths aimed to introduce experimentally the phenomenon of surface tension.

4. Playing whit self-assembling

The first educational experiment we propose (based on Magic Sand) aims at illustrating the phenomenon of *hydrophobicity-driven self-assembly*, on a macroscopic scale directly accessible to the human eye. To this end, some polystyrene chunks (Figure 4) were coated either with normal sand (NS, strongly hydrophilic) or with Magic sand (MS, strongly hydrophobic). Two such chunks were put in water, letting them to freely float. Then, students gently push the chunks one against the other (by using, for example, a clean drinking straw) observing what happens. The experiment is repeated by using all three possible couple of coated chunks (NS-NS, MS-MS, NS-MS) and the observations are compared and discussed. The experimental outcome is a bit surprising (especially if one is unfamiliar with the Magic Sand behaviour): MS-MS chunks

exhibit an evident attraction, NS-NS chunks manifest a repulsive interaction, while the MS-NS couple doesn't show any evident interaction (neither attractive nor repulsive).

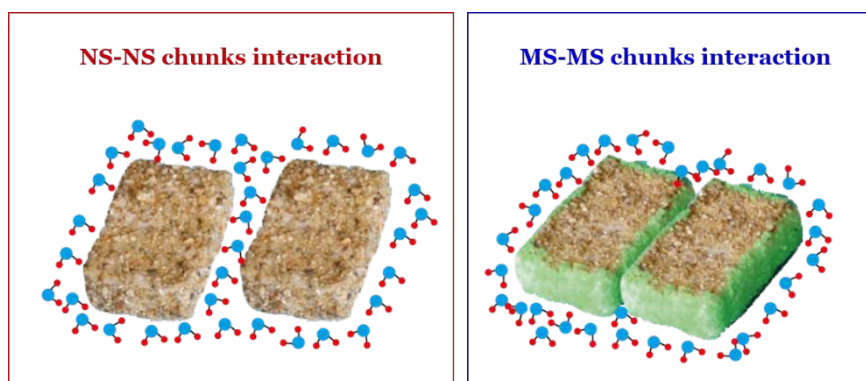

Figure 5. Pictorial representation of the collective interaction of water molecules (blue/red dots) with polystyrene chunks coated with normal sand (NS, left) and magic sand (MS, right). Water molecules are graphically modelled as two hydrogen atoms (red dots) rigidly linked to an oxygen (blue dot). The H-O-H angle in figure is only indicative, since accordingly with usual pedagogical models (Laing, 1987; Yalkowsky, 1993) it can range between 90° and 105° depending on the model.

Figure 5 gives the conceptual key to interpret the experimental outcomes. When two NS-coated chunks come close each other, water molecules are not completely expelled from the gap between them, because the highly hydrophilic boundaries of the gap have a great affinity towards water. In other words, water molecules are “pulled” in the opening between the hydrophilic bodies, “pushing” them away (left side of Figure 5). On the other hand, when two MS-coated chunks are approaching one another, the expulsion of water molecules from the gap very easily happens, being energetically favourable since it leads to the minimization of the super-hydrophobic surface exposed to water (right side of Figure 5). This collective “expulsion” of water molecules macroscopically results in an “attraction” between chunks.

The experimental exploration of self-aggregation phenomena can be extended at will, for example building “amphiphilic” rods and qualitatively observing the mean configuration when a number of them is allowed to float on water (one can simply build “amphiphilic” rods by MS-coating one end tip of some wooden toothpick, since the wood they are made of is usually very hydrophilic). Gently moving rods, with some patience, occasionally one can observe the formation of radial structures in which the super-hydrophobic tips of the rods meet together, minimizing the exposition to water.

5. Elasticity of water

Water is (slightly) viscous, but probably any student (and teacher) agree on the fact that it is by no means elastic! This is certainly true when considering almost exclusively the *volume properties* of water; while the situation can be very different when the *surface properties* come more and more into play, i.e. when the surface/volume ratio is relevant, for example, when considering small drops.

Therefore, educational experiments with droplets can in principle offer a useful and rich context to illustrate the effects of surface tension of water in a visually impressive way. This is especially true when the elastic behaviour of droplets can be dynamically explored by means of high speed video analysis (Bonanno et al. 2013).

The main obstacle against such a kind of experiments is constituted by the material support employed to (statically or dynamically) handle the drops, which usually spread out (or stick) to some extent on the vast majority of common surfaces. This problem can be overcome by using super-hydrophobic surfaces to support drops. We obtained our own home-made super-hydrophobic support by coating a microscope glass slide with a finely ground MS powder. Figure 6 shows the experimental setup we used, allowing us to precisely control the horizontality of the super-hydrophobic support for drops. This is a critical issue, since drops, on such a support, are extremely mobile and rolls away very easily if the support is not perfectly horizontal.

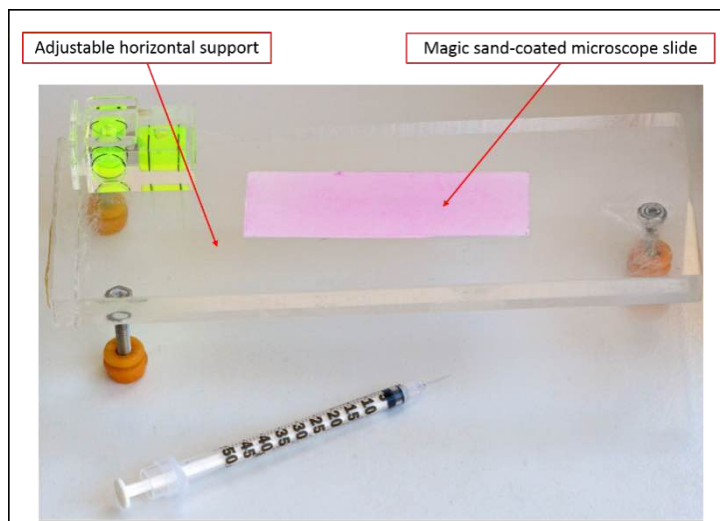

Figure 6. Experimental setup for experiments with water drops

Various kind of experiments can be done with the simple apparatus in Figure 6. We give in the following some significant, but not exhaustive, example.

Figure 7 shows a qualitative comparison between the contact angles formed (on the same surface) by a pure water drop and a drop of soapy water (in order to improve the visibility of water it has been added with a small amount of fluorescein, which doesn't significantly change its surface tension). The effect of soap in reducing the water's surface tension is very evident from the marked reduction of the contact angle. Such an experiment can be done quantitative by measuring the contact angle (by means of a freeimage software, such as *GIMP*) when the soap concentration is varied.

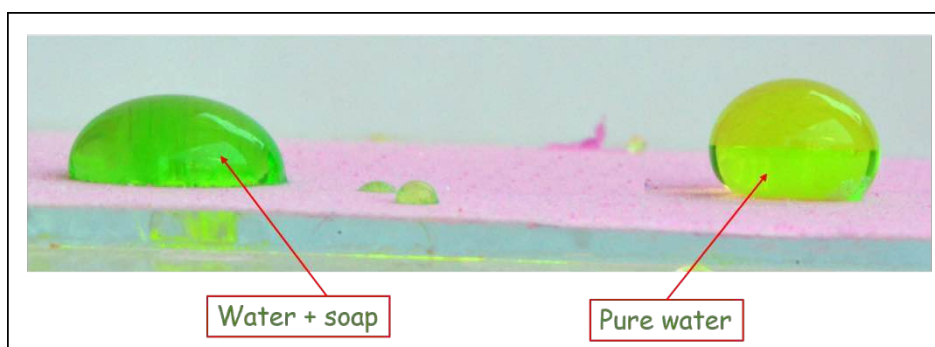

Figure 7. Effect of soap on the water's surface tension visualized through the contact angle variation.

Another significant class of experiments can be performed to investigate the dynamic (elastic) behaviour of water droplets, for example when bouncing on a super-hydrophobic surface. Figure 8 shows a frame sequence of an high-speed video taken by using a commercial-grade camera capable of shooting up to 1200 frames per second (Nikon 1 V2)¹. The sequence (time interval between frames = 2.5 ms) corresponds to the partially elastic impact of a water drop on a MS-coated glass slide. The video analysis of drop impact can be used both for illustrative purposes and for quantitative measurements, for example by using the software *Tracker* (Tracker 2014).

¹ Such a kind of device is affordable for a school lab and can be termed "economic" in its kind, since it costs a few hundred Euros, in comparison with the tens of thousands of a professional high speed camera.

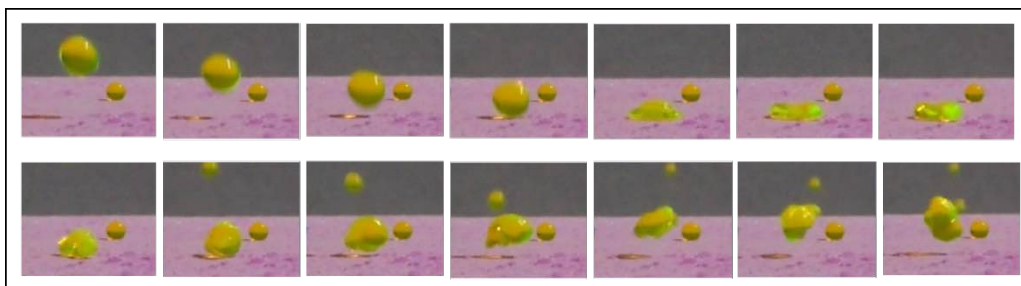

Figure 8. Frame sequence of a fluoresceine-coloured water drop bouncing on a MS-coated surface (the time interval between frames is around 2 ms).

Dynamic experiments aimed to determine the degree of elasticity of a drop impacting on a surface can also be usefully done by using as super-hydrophobic surface that obtained by an Aqua Drop toy.

6. Conclusions

In this work we suggest a series of experimental educational activities, based on super-hydrophobic toys (and on cheap components easily obtainable by these toys), allowing high school students to get in touch with intriguing phenomena concerning water properties, which have a great interdisciplinary relevance (especially at the crossway among physics, biology and chemistry). The experiments we proposed can be carried out with simple teaching equipment and are well suited to undergraduate students. In particular, they:

- Provide a rich context for inexpensive and impressive experiments on water properties arising from surface tension;
- Allow building original demonstrations/experiments helping to highlight hydrophobicity as the “emerging” property that constitutes the “driving force” of very important cross-disciplinary phenomena such as auto-aggregation of macromolecules.
- Can be extended to the dynamical (surface tension-driven) behavior of water, by means of cheap (but advanced) imaging devices, so highlighting peculiar phenomena on a timescale too short for the human perception.

The described experiments have been proposed to high school students in the context of an Orientation Program, held at the Campus of the University of Calabria during the spring 2014. The ludic and visually oriented character of the proposed activities has aroused considerable interest from the students, who have spontaneously built conceptual links between a numbers of topics they learned at school in the context of different disciplines (chemistry, biology, and physics) without seizing— at that time - the mutual connections. Finally, suggested experiments (which are suitable for high school students) can also be “downgraded” at various levels, including a very simple and illustrative level suitable for primary school pupils.

References

- Bonanno A., Bozzo G., Sapia P., “A high-speed walk through non-Newtonian fluids”, *International Conference: Multimedia in Physics Teaching and Learning (MPTL 18)*. Madrid, Spain, 11 - 13 September 2013.
- Huttermann A., Terzidis O. (2010). Emergence in physics, *International Studies in the Philosophy of Science*. **14**, 267-281.
- Laing M. (1987). No rabbits ears on water, *J. Chem. Educ.* **64**, 124-128.
- MagicSand (2014). See for example: http://en.wikipedia.org/wiki/Magic_sand or <http://www.teachersource.com/product/magic-sand/chemistry>
- Sacristan J. (2014). Autoaggregation of amphiphilic molecules. On line at the URL: <http://goo.gl/3II2en>
- Science Creative Quarterly (2004). *The beginning of life and amphiphilic molecules*. Online at the URL: <http://goo.gl/yal43Z>
- Shakerin S (2011). Lotus effect toy, *The Phys. Teach.* **49**, 346-347.
- Tracker (2014). *Video Analysis and Modeling Tool for Physics*. Freely available at the URL: <https://www.cabrillo.edu/~dbrown/tracker/>
- Yalkowsky S.H. (1993). A two-dimensional model for water, *J. Chem. Educ.* **70**, 614-615.

Affiliation and address information

Peppino Sapia
Physics Education Research Group
Department of Biology, Ecology and Earth Sciences
University of Calabria
Ponte Bucci, cubo 4B
87036 Rende, CS
Italy
e-mail: peppino.sapia@unical.it

Explaining Phenomena Scientifically and Identifying Scientific Issues in Physics Education: Some Interesting Observations of the High-Performing Economies in PISA 2006

Kwok-cheung Cheung

Faculty of Education, University of Macau

Abstract

This paper analyses student performance of the twelve high-performing economies in PISA 2006 on the two released test units (i.e. CLOTHES, THE GRAND CANYON) so as to understand to what extent students are able to explain physical phenomena scientifically, and identify issues for scientific investigation in the laboratories. Item analyses of the released items reveal that students make mistakes which are often explainable in terms of their opportunities to learn in their school curriculum and informal settings, and they are generally weak in the identification of issues for scientific investigations. Another interesting finding of this study is that a country's enjoyment of science learning is negatively associated with its scientific literacy performance. Sensibly, the eleven high-performing economies in PISA 2006 do not go to the two affective extremes and they are all having medium level of enjoyment of science learning. Implications for pedagogy, curriculum design, and teacher education are discussed.

Keywords

Scientific literacy; physical knowledge; scientific inquiry; PISA

1. Introduction

Explaining phenomena in physical systems scientifically and identifying scientific issues for purposes of scientific inquiry in the laboratories are important outcomes of physics education for the junior secondary students around the world today. Regarding this, in 2006, OECD's *Programme for International Student Assessment* (PISA) conducted a comprehensive sampled survey of 15-year-old secondary students to assess their scientific literacy performance, and based on the questionnaire responses examined factors explaining performance variations from a comparative education perspective. The eleven top-performing economies in scientific literacy performance in PISA 2006 are: Finland, Hong Kong, Canada, Chinese Taipei, Estonia, New Zealand, Japan, Australia, Netherlands, Liechtenstein and Korea. The followings elucidate how students from the high-performing economies demonstrate what they can do what they know in two released test units, as well as examine at the country level the relationship between enjoyment of science learning and scientific literacy performance.

2. How students from high-performing economies demonstrate what they can do what they know in two released PISA 2006 test units?

After the dissemination of the PISA 2006 results, a few exemplary test units have been released to the public so that the various stakeholders can understand how scientific literacy and its constituent competencies are assessed internationally (see OECD, 2007, 2009 and 2013). For example, the two test units CLOTHES and THE GRAND CANYON render sampled students opportunities to deploy both the *knowledge of physical science* (i.e. knowledge of phenomena pertaining to electricity and heat in the physics curriculum) and *knowledge about science* (i.e. identifying scientific issues for scientific inquiry in areas such as *frontiers of science and technology* and *the living environment*) to answer the 5 items in the two test units. It is the PISA 2006 Expert Group's conviction that the test units purport to assess what students can do with what they know in their daily lives as a result of science education in their schools.

Drawing data from the PISA 2006 database which is publicly available on the web, it is possible to compare student's scientific literacy performance in these two released test units amongst the afore-mentioned eleven top-performing economies. Some interesting findings regarding how students of these high-performing economies are able to demonstrate what they can do what they know in the physics lessons, i.e. *explaining phenomena scientifically* and *identifying scientific issues*, are summarized.

3. Test Unit: Clothes (OECD, 2007, p. 89-90)

Read the text and answer the questions that follow.

A team of British scientists is developing “intelligent” clothes that will give disabled children the power of “speech”. Children wearing waistcoats made of a unique electro textile, linked to a speech synthesizer, will be able to make themselves understood simply by tapping on the touch-sensitive material.

The material is made up of normal cloth and an ingenious mesh of carbon impregnated fibres that can conduct electricity. When pressure is applied to the fabric, the pattern of signals that passes through the conducting fibres is altered and a computer chip can work out where the cloth has been touched. It then can trigger whatever electronic device is attached to it, which could be no bigger than two boxes of matches.

“The smart bit is in how we weave the fabric and how we send signals through it – and we can weave it into existing fabric designs so you cannot see it’s in there,” says one of the scientists.

Without being damaged, the material can be washed, wrapped around objects or scrunched up. The scientist also claims it can be mass-produced cheaply.

Source: Steve Farrer, ‘Interactive fabric promises a material gift of the garb’, The Australian, 10 August 1998.

Item 1 (Clothes):

Can these claims made in the article be tested through scientific investigation in the laboratory?

Circle either “Yes” or “No” for each.

The material can be	Can the claim be tested through scientific investigation in the laboratory?
washed without being damaged.	Yes / No
wrapped around objects without being damaged.	Yes / No
scrunched up without being damaged.	Yes / No
mass-produced cheaply.	Yes / No

According to the coding guide, full credit is awarded if the responses are “Yes, Yes, Yes, No” in that order. This is a complex multiple choice item written in social setting, with competency pertaining to “identifying scientific issues”. The knowledge category is “scientific enquiry” and the application area is “frontiers of science and technology”. The difficulty index of this item is 567, indicating that it is a rather difficult item. Table 1 shows that amongst all the OECD member countries, the passing rate is only 48%. Liechtenstein, Finland, Australia, Hong Kong and Canada are the five economies with passing rate exceeding 60%. Noteworthy is that even in these five top-performing economies, there are around 30-40% of the students do not understand comprehensively how to identify issues for purposes of scientific investigation in the laboratory.

Table 1. Percentage of response of item 1 (Clothes) of the 11 top-performing economies

	% of Response				
	0 (no credit)	1 (full credit)	Invalid	Missing	Not reached
Finland	31.91	67.75	--	0.14	0.20
Hong Kong- China	37.04	62.67	--	0.14	0.15
Canada	38.22	60.75	--	0.80	0.24
Chinese Taipei	48.68	50.71	--	0.43	0.18
Estonia	44.05	55.64	--	0.31	--
Japan	46.47	52.13	0.05	1.10	0.25
New Zealand	39.74	59.10	0.09	0.45	0.62
Australia	36.47	62.83	--	0.55	0.14
Netherlands	44.21	55.67	--	0.12	--
Liechtenstein	28.93	71.07	--	--	--
Korea	51.05	48.73	--	0.16	0.06
OECD average	51.24	47.69	0.02	0.64	0.41

Item 2 (Clothes):

Which piece of laboratory equipment would be among the equipment you would need to check that the fabric is conducting electricity?

- A. Voltmeter
- B. Light box
- C. Micrometer
- D. Sound meter

According to the coding guide, full credit is awarded to response “A”. This is a simple multiple choice item written in personal setting, with competency pertaining to “explaining phenomena scientifically”. The knowledge category is “technology systems” and the application area is “frontiers of science and technology”. The difficulty index of this item is 399. This is a relatively easy item as on average across OECD member countries around 80% of the students are able to answer this item correctly (see Table 2). Those of Finland, Hong Kong and Chinese Taipei are even over 90%. Amongst the three distractors (i.e. B, C and D), a higher percentage of students from New Zealand choose B (i.e. light box), from Canada, New Zealand and Australia choose C (i.e. micrometer), and from Liechtenstein chooses D (i.e. sound meter).

Table 2. Percentage of response of item 2 (Clothes) of the 11 top-performing economies

	% of Response						
	A (full credit)	B	C	D	Invalid	Missing	Not reached
Finland	94.74	1.47	2.23	0.96	--	0.40	0.20
Hong Kong- China	91.75	4.37	2.17	0.83	0.07	0.57	0.23
Canada	83.06	4.30	7.14	3.57	0.17	1.18	0.58
Chinese Taipei	93.99	2.18	2.25	1.06	0.03	0.22	0.27
Estonia	87.94	1.49	3.76	5.15	0.35	1.18	0.13
Japan	80.80	4.28	7.87	5.20	0.58	0.96	0.31
New Zealand	80.63	7.04	6.92	2.92	0.40	1.48	0.62
Australia	81.44	5.36	7.92	3.62	0.30	1.18	0.19
Netherlands	87.08	3.68	5.45	2.86	0.34	0.60	--
Liechtenstein	85.09	3.71	3.72	7.48	--	--	--
Korea	88.20	3.84	5.06	2.30	0.23	0.32	0.06
OECD average	79.01	5.82	6.89	5.38	0.47	1.94	0.49

4. Test Unit: The Grand Canyon (OECD, 2007, p.91-93)

The Grand Canyon is located in a desert in the USA. It is a very large and deep canyon containing many layers of rock. Sometime in the past, movements in the Earth’s crust lifted these layers up. The Grand Canyon is now 1.6 km deep in parts. The Colorado River runs through the bottom of the canyon.

See Figure 1 below of the Grand Canyon taken from its south rim. Several different layers of rock can be seen in the walls of the canyon.

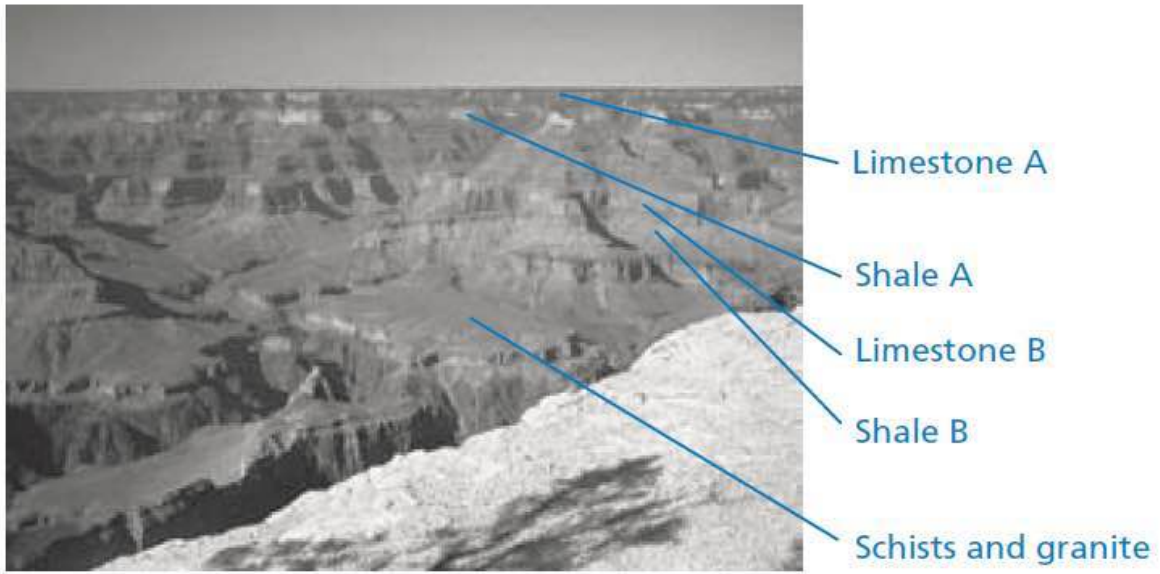

Figure 1. Stimulus of test unit – the Grand Canyon

Item 3 (The Grand Canyon):

About five million people visit the Grand Canyon national park every year. There is concern about the damage that is being caused to the park by so many visitors.

Can the following questions be answered by scientific investigation? Circle “Yes” or “No” for each question.

Can this question be answered by scientific investigation?	Yes or No?
How much erosion is caused by use of the walking tracks?	Yes / No
Is the park area as beautiful as it was 100 years ago?	Yes / No

According to the coding guide, full credit is awarded to responses “Both correct: Yes, No” in that order. This is a complex multiple choice item written in social setting, with competency pertaining to “identifying scientific issues”. The knowledge category is “scientific enquiry”, and the application area is “environment”. The difficulty index of this item is 485, showing that it is a moderately easy item. Table 3 shows that amongst all OECD member countries, the passing rate is around 60%. New Zealand, Australia, and Korea are the three economies with passing rate exceeding 70%. Noteworthy is that even in these three top-performing economies, there are at least one in four of the students do not understand how to identify issues for purposes of scientific investigation in the laboratory.

Table 3. Percentage of response of item 3 (The Grand Canyon) of the 11 top-performing economies

	% of Response				
	0 (no credit)	1 (full credit)	Invalid	Missing	Not reached
Finland	33.32	65.53	--	0.29	0.86
Hong Kong- China	31.84	67.17	--	0.44	0.56
Canada	30.44	67.59	0.01	1.16	0.81
Chinese Taipei	35.89	63.61	--	0.27	0.23
Estonia	39.88	58.96	--	0.94	0.22
Japan	44.99	53.33	--	0.88	0.81
New Zealand	25.95	71.92	--	1.09	1.04
Australia	25.82	72.93	0.01	0.72	0.52
Netherlands	36.64	63.03	--	0.13	0.20
Liechtenstein	34.63	63.38	1.00	1.00	--
Korea	26.78	72.02	--	0.90	0.30
OECD average	36.90	60.75	0.04	1.35	0.96

Item 4 (The Grand Canyon):

The temperature in the Grand Canyon ranges from below 0 °C to over 40 °C. Although it is a desert area, cracks in the rocks sometimes contain water. How do these temperature changes and the water in rock cracks help to speed up the breakdown of rocks?

- A. Freezing water dissolves warm rocks.
- B. Water cements rocks together.
- C. Ice smoothes the surface of rocks.
- D. Freezing water expands in the rock cracks.

According to the coding guide, full credit is awarded to response “D”. This is a simple multiple choice item written in social setting, with competency pertaining to “explaining phenomena scientifically”. The knowledge category is “earth and space systems” and the application area is “environment”. The difficulty index of this item is 451. This is a moderately easy item as on average across OECD member countries around 67% of the students are able to answer this item correctly (see Table 4). Those of Canada and Chinese Taipei are even over 75%. Amongst the three distractors (i.e. A, B and C), a higher percentage of students from Estonia, Netherlands choose A (i.e. Freezing water dissolves warm rocks), from Australia and Korea choose B (i.e. Water cements rocks together), and from Finland, Japan and Liechtenstein choose C (i.e. Ice smoothes the surface of rocks). In terms of plausibility, distractor A is higher than B and C not only across OECD member countries but also in nine of the eleven top-performing economies in PISA 2006.

Table 4. Percentage of response of item 4 (The Grand Canyon) of the 11 top-performing economies

	% of Response						
	A	B	C	D (full credit)	Invalid	Missing	Not reached
Finland	6.40	3.56	14.17	72.57	1.98	0.47	0.86
Hong Kong- China	14.20	7.03	5.33	71.35	0.13	1.40	0.56
Canada	6.27	5.88	6.89	78.76	0.27	1.06	0.87
Chinese Taipei	10.30	7.75	4.64	76.27	0.14	0.68	0.23
Estonia	15.55	6.60	6.25	68.15	1.85	1.38	0.22
Japan	13.88	7.31	9.45	67.19	--	1.36	0.81
New Zealand	11.12	8.10	6.67	71.12	0.10	1.76	1.13

Australia	11.84	8.80	6.11	71.31	0.15	1.26	0.53
Netherlands	15.14	5.09	6.89	71.64	0.18	0.85	0.20
Liechtenstein	10.62	6.76	10.54	71.16	0.92	--	--
Korea	13.30	8.62	6.35	69.82	0.19	1.41	0.30
OECD average	10.93	8.49	9.26	66.97	1.02	2.33	1.01

Item 5 (The Grand Canyon):

There are many fossils of marine animals, such as clams, fish and corals, in the Limestone A layer of the Grand Canyon. What happened millions of years ago that explains why such fossils are found there?

- A. In ancient times, people brought seafood to the area from the ocean.
- B. Oceans were once much rougher and sea life washed inland on giant waves.
- C. An ocean covered this area at that time and then receded later.
- D. Some sea animals once lived on land before migrating to the sea.

According to the coding guide, full credit is “C”. This is a simple multiple choice item written in social setting, with competency pertaining to “explaining phenomena scientifically”. The knowledge category is “earth and space systems” and the application area is “natural resources”. The difficulty index of this item is 411. This is a relatively easy item as on average across OECD member countries around 75% of the students are able to answer this item correctly (see Table 5). Those of Finland, Chinese Taipei and Korea are even over 85%. Amongst the three distractors (i.e. A, B and D), a higher percentage of students from Hong Kong and Netherlands choose A (i.e. In ancient times, people brought seafood to the area from the ocean), from Hong Kong, Netherlands, and Liechtenstein choose B (i.e. Oceans were once much rougher and sea life washed inland on giant waves). In none of the 12 top-performing economies there are a higher percentage of students than that of the average of the OECD member countries choose D (i.e. Some sea animals once lived on land before migrating to the sea). Noteworthy is that amongst the three distractors B is the most powerful one attracting the weaker students to choose it. The exception is Australia where D is slightly more plausible than B.

Table 5. Percentage of response of item 5 (The Grand Canyon) of the 12 top-performing economies

	% of Response						
	A	B	C (full credit)	D	Invalid	Missing	Not reached
Finland	2.86	4.36	86.22	3.89	0.46	1.35	0.86
Hong Kong- China	3.43	14.55	73.84	4.36	0.09	3.11	0.62
Canada	2.31	6.48	82.49	5.86	0.24	1.61	1.01
Chinese Taipei	2.72	6.64	85.70	3.50	0.05	1.16	0.23
Estonia	2.54	6.18	84.49	2.75	1.06	2.71	0.28
Japan	2.73	6.98	83.67	4.09	--	1.66	0.86
New Zealand	2.31	5.64	82.93	5.57	0.15	2.27	1.13
Australia	2.55	5.75	83.20	5.89	0.13	1.93	0.55
Netherlands	4.18	10.88	78.04	5.04	0.09	1.57	0.20
Liechtenstein	1.89	15.30	77.00	5.81	--	--	--
Korea	2.62	7.88	85.34	2.16	0.12	1.58	0.30
OECD average	3.35	10.28	75.00	6.71	0.56	2.98	1.11

5. Relationships between an educational system’s scientific literacy performance and enjoyment of science learning

Another purpose of the present study is to find out whether there is any statistically significant association between an educational system’s scientific literacy performance and enjoyment of science learning (see OECD, 2007, p.337 for the definition of the enjoyment of science constructs). Sensibly, an educational

system is considered exemplary in its science education provisions only if it is high-performing in scientific literacy (and its constituent components), as well as that its students' enjoyment of science learning is also of the highest level amongst all participating economies in PISA 2006.

Figure 2 reveals that in PISA 2006 there is a strong negative correlation between an educational system's mean scientific literacy performance and enjoyment of science learning ($r = -0.741$). Amongst the eleven economies, the five top-performing economies Finland, Hong Kong, Canada, Chinese Taipei, and Estonia which topped the PISA 2006 league table on one hand are able to achieve highly in scientific literacy performance and on the other hand can strike a balance not to go to the two affective extremes regarding student enjoyment of science learning (i.e. index of enjoyment of science learning ranges between 0.0 to 0.4). These five economies may be crowned as exemplars in science education in the world. However, Netherlands, Japan, Liechtenstein, Korea, Australia, and New Zealand may not be considered as exemplary educational systems because their students indicate that their science learning experiences are far from enjoyable compared with the rest of the participating economies in PISA 2006.

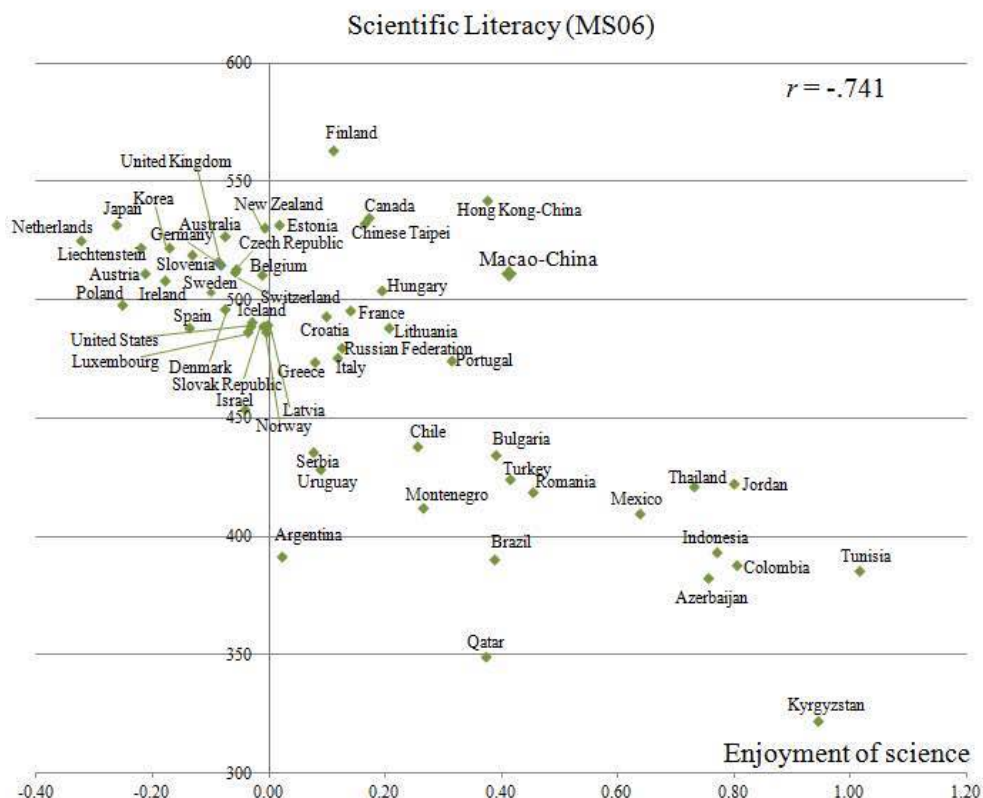

Figure 2. Relationship between mean scientific literacy performance and enjoyment of science learning of participating economies in PISA 2006

6. Implications of the Study

Years in the past decade witnessed educational research provides evidence-based empirical findings informing educational practitioners the instructional pathways on how to improve student performance in science, enjoyment of science, and epistemological awareness for becoming a scientific literate person (e.g. Cheung, 2013). However, it is also a reality that classroom practices are often slow or resistant to make reference to these findings for improvement. More research is needed to be done for the various stakeholders with a bearing for quality K-12 science education around the world. The implications of the three key findings are discussed below:

First, in the area of “explaining phenomena scientifically”, based on the distractor analyses results of the multiple choice items, readers can find out the prevalence of alternative conceptions of students in each economy, whether it is high-performing or not. For example, in Canada, New Zealand and Australia there are approximately 7% of the sampled students thinking that they can use a micrometer to check whether the special fabric described in the stimulus is conducting electricity or not. In Estonia and Netherlands around 15% of the sampled students use the naïve conception “freezing water dissolves warm rock” to explain how

the large variation in temperature causes the water in the cracks of the rock speed up the breakdown of the rocks. In Hong Kong, Netherlands and Liechtenstein, 11-15% of the sampled students use another misconception “Oceans were once much rougher and sea life washed inland on giant wave” to explain why there are so many fossils of marine animals in the limestone layer of the Grand Canyon. These findings have pedagogical implications for the economies concerned.

Second, in the area of “identifying scientific issues” for investigation, noteworthy in the two test units examined in the present study is that quite a considerable proportion of students in the OECD member countries cannot make correct judgment. However, most students from Liechtenstein, Finland, Australia, New Zealand, Canada, Hong Kong and Korea can. May be in these high-performing economies “knowledge about science” are relatively more emphasized in their school curriculum, or students have more opportunities to encounter the concerned scenarios in informal setting. As these economies cover most parts of the world, readers can make a choice and make reference to their successful experiences accordingly.

Last, but not least, while students from Tunisia, Kyrgyzstan, Columbia, etc. enjoy their science learning a lot their scientific literacy performance are the lowest of all participating economies in PISA 2006. Given such a negative relationship between a country’s scientific literacy performance and enjoyment of science, the wise move is to attain high cognitively and at the same time not to go to two affective extremes regarding students’ enjoyment of science. The five top-performing economies in PISA 2006, i.e. Finland, Hong Kong, Canada, Chinese Taipei, and Estonia are like this, and their successful science education experiences are very valuable to be modelled upon.

References

OECD (2007). *PISA 2006 – Science competencies for tomorrow’s world. (Volume 1: Analysis)*. OECD Publishing.

OECD (2009). *Green at fifteen? How 15-year-olds perform in environmental science and geoscience in PISA 2006*. OECD Publishing.

OECD (2013). *PISA 2012 assessment and analytical framework: Mathematics, reading, science, problem solving and financial literacy*. OECD Publishing.

Cheung, K.C. (2013). *Active learning in physics classrooms for enquiry-based instruction: Lessons learned from the PISA 2006 study*. Macao: Educational Testing and Assessment Research Centre, University of Macau.

Affiliation and address information

Kwok-cheung Cheung
Educational Testing and Assessment Research Centre
University of Macau
Macao, China
email: kccheung@umac.mo

A Dynamical Model for the Rolling Cylinder

Michele D'Anna

Liceo cantonale, Locarno

Abstract

In this contribution we present a model for the rolling motion that can be used at high school level. Starting from the observed behavior of a rolling cylinder accelerated in different ways, we introduce a model based on the exchange of linear and angular momentum between the rolling body and the underlying surface. The main point is that in rolling without sliding, the ratio of angular momentum and linear momentum has a constant value, so that their rates of change also satisfy the same condition. Using the equations of motion (interpreted as balance equations for linear and angular momentum) we can derive the forces and torques that characterize the interaction between the rolling object and the surface in a simple way. In a second step we complete the model introducing the energetic aspects and we examine in particular the motion of a cylinder coming to rest on a rough surface. Our analysis lets us argue that, in absence of gliding, *only* the angular momentum exchange between the rolling cylinder and the surface is responsible for the dissipative process.

Keywords

Rolling motion without sliding, dynamical model, energy exchanges, dissipative process.

1. Introduction

Many students encounter severe difficulties in seizing the concepts that allow an adequate description of the processes of rolling motion, especially in relation to the formalism that usually accompanies their presentation [Show, 1979], [Salazar, 1990], [McClelland, 1991], [Carnero, 1993], [Pinto, 2001]. For most of the concepts and relations students are not able to go beyond the algebraic formulation, which makes it difficult for them to acquire these tools as a real instrument of thought. In a recent paper Harrer pointed out that it is important to pay attention to the productive resources in students' ideas, in particular in relation to the role of some physical quantities modelled as metaphorical substances [Harrer, 2013]. In this contribution we'll motivate and illustrate an approach to the *rolling motion* based on the extensive quantities *linear momentum* and *angular momentum* and their exchanges between the rolling body and the underlying surface. The energy aspects will be incorporated in a similar way, exploiting the basic relations between forces (interpreted as the quantities that give us the strength of the linear momentum flows) and torques (interpreted as the quantities that give us the strength of the angular momentum flows) that characterise the interaction with the surface and the energy exchanges. On the basis of these basic images, students will be able to build a coherent model in order to describe first verbally and then formally the processes that occurs by rolling motion of an object on a surface.

2. Introductory example: two ways to get a cylinder to rotate

First we consider a metallic cylinder that can roll on an horizontal surface and that can be put in rotation in two *different ways*¹: the first through the twisting action of a flexible rubber hose, suitably fixed to one of the

¹ I am grateful to Professor P. Mascheretti for discussions on rolling motion and for drawing my attention to the experiments that constitute the starting point of the work presented here [Borghi, 2005]. Videos of the experiments presented in this paper can be seen online at <http://youtu.be/cKTgjO5CNDs> (Fig. 1), <http://youtu.be/79C6T1RQL8s> (Fig. 2) and <http://youtu.be/belikhyhgxE> (Fig. 7).

two hubs; the second dragging it with a special hook that acts on two hubs fixed laterally along the axis of the cylinder.

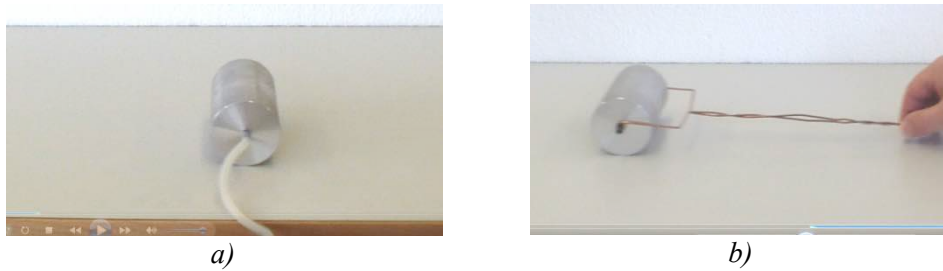

Figure 1. The experimental set up.

In both cases, the cylinder is set in motion in such a way that there is pure rolling (i.e. avoiding sliding) and so that the speed reached by the cylinder at the end is exactly the same. We all know that in order to prevent sliding, in both situations a static friction force or better a *shear adhesion force* is needed. Since it is possible to generate *exactly* the same motion with both strategies it is interesting to consider the following question: can the table feel which method we are using to accelerate the cylinder? The first method or the second one?

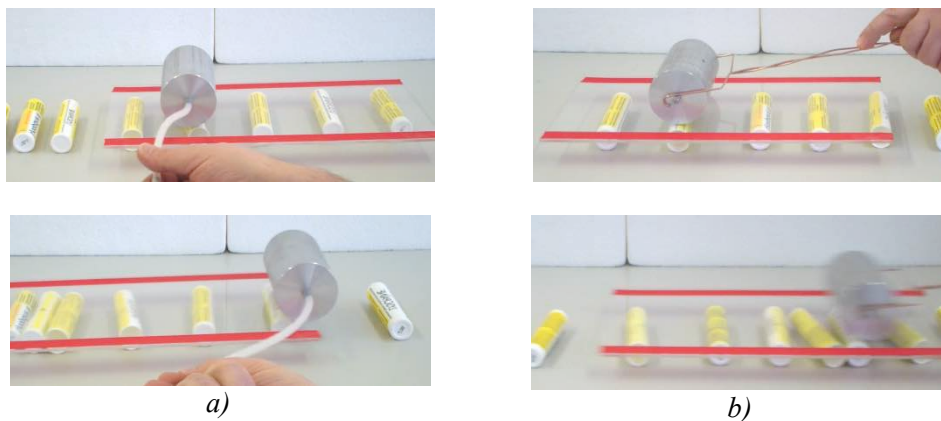

Figure 2. The acrylic plate gives us a clear answers: in the two situations there is a difference in the interaction between cylinder and surface.

In order to get an answer from the table we might change a little bit the set up: we can perform the same experiments on a light acrylic plate which is mechanically insulated from the underlying surface by some rollers (see figure 2). The answer is quite simple: yes, the underlying surface can discriminate between the two strategies! But how can we understand all this?

3. The reference model

We interpret the rolling motion of the cylinder as the superposition of an horizontal translation of the (centre of mass of the) cylinder with a rotation around the centre of mass. We then introduce the quantities needed in order to describe the dynamics of the motion, i.e. *linear momentum* and *angular momentum*.

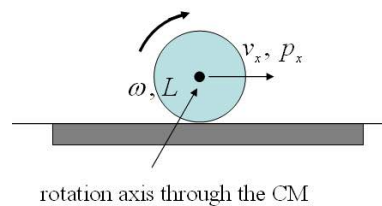

Figure 3. Kinematical and dynamical variables.

So far as the cylinder really rolls, i.e. so far as there is no sliding, we also have to fulfill the usual *rolling condition*:

$$v_x = R \omega . \quad (1)$$

From the constitutive relations for the cylinder:

$$p_x = M v_x \quad (2a)$$

$$L = \theta \omega = \frac{1}{2} M R^2 \omega \quad (2b)$$

(where M is the mass and θ represents the moment of inertia of the cylinder) we obtain:

$$\frac{L}{p_x} = \frac{\theta \omega}{M v_x} = \frac{\frac{1}{2} M R^2 \omega}{M R \omega} = \frac{1}{2} R. \quad (3)$$

In other words, the *ratio of angular and linear momentum* assumes a value that *depends* only on some geometrical factors but that is *independent* of what happens to the cylinder. This means that in every situation also the ratio of the *rate of change* of angular momentum and linear momentum must satisfy the same condition.

In addition, considering the master equations for linear and rotational motion:

$$\dot{p}_x = F_{x,tot} \quad (4a)$$

$$\dot{L} = \tau_{tot} \quad (4b)$$

we conclude that the same relation should be valid also for the ratio between the *total torque* and the *total force* acting on the rotating cylinder:

$$\frac{L}{p_x} = \frac{\dot{L}}{\dot{p}_x} = \frac{\tau_{tot}}{F_{x,tot}} = \frac{1}{2} R \quad (5)$$

Finally, we can express the rolling condition by the following dynamical relation:

$$F_{x,tot} = \frac{2 \tau_{tot}}{R} \quad (6)$$

This relation will represent the key point in our further reasoning in the different situations.

4. Rolling *without* dissipative processes

From this perspective we now analyse the two introductory situations. We *assume* that by these examples dissipative processes can be neglected². This means that if we know what kind of external action we are performing on the cylinder, we can exactly determine, according to the general scheme outlined in figure 4, what happens between cylinder and underlying surface, i.e. we can exactly determine both the value of the shear adhesion force and the value of the correlated torque:

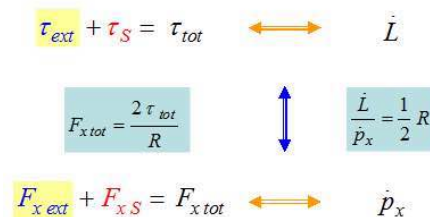

Figure 4. General scheme that permits to analyse the different situations.

Let us discuss the first situation. By twisting the cylinder, through the torque we are exerting, we transfer to the cylinder *only* angular momentum: *in order to prevent sliding and fulfil the rolling condition*, a static adhesion force is needed which transfers the *missing* momentum from the surface to the cylinder. In the “force picture”, this *static adhesion force* acts on the cylinder from left to right; this means that the force of

² This assumption can be supported by separate experiments: measuring the velocity of a free rolling cylinder on the same surface, it is possible to quantify the effective deceleration. Quantitative results indeed suggest that by these conditions the effect of dissipation can be neglected. We’ll discuss a situation where this assumption is no longer correct in the last example, after introducing the energy aspects in our model.

the cylinder on the surface must be directed on the left, as experimentally observed: *the platform moves in the opposite direction than the cylinder* (see figure 5).

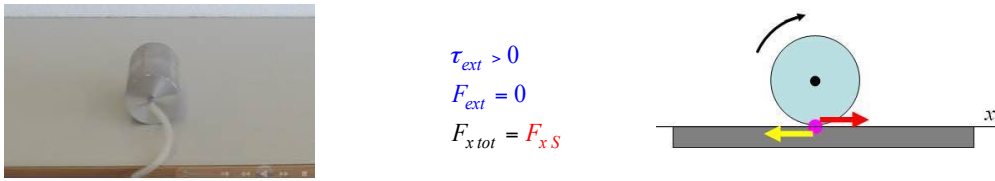

Figure 5: The twisted cylinder.

We now turn to the second situation. By dragging the cylinder, trough the force we are exerting, we transfer to the cylinder *only* linear momentum: again, *in order to prevent sliding and fulfil the rolling condition*, a static adhesion force is needed, which this time transfers both, the *exceeding* momentum from the dragged cylinder to the surface, and the *missing* angular momentum from the surface to the cylinder. Indeed, more formally, from the previous relation we obtain:

$$F_{x, tot} = \frac{2 \tau_{tot}}{R} = -2 F_{x, S} \tag{7a}$$

$$F_{x S} = F_{x tot} - F_{x ext} = -\frac{1}{3} F_{x ext} \tag{7b}$$

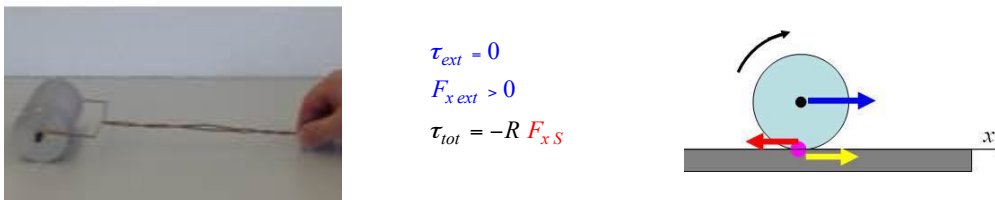

Figure 6: The dragged cylinder.

In the force picture, this *static adhesion force* acts on the cylinder from right to left; this means that the force of the dragged cylinder on the surface must be directed on the right, as experimentally observed: *the platform moves in the same direction as the cylinder* (see figure 6).

5. Rolling with dissipative processes (but without sliding)

We are now ready to consider situations *with dissipative processes*, but still *without sliding*. This means that we consider situations where the dissipative process arises from deformations of the cylinder and / or of the surface. We can start by adopting the generally accepted description for the interaction between rolling object and surface, adopting the usual force picture that reduces this extended interaction to a point like one: a phenomenological description of the whole interaction between surface and rolling object is reached introducing a force whose attack point is forward shifted (respect to the symmetry axis of the cylinder). The breaking effect is then obtained by virtue of the torque generated by the normal component of this mechanical interaction, an quantified by its displacement length *D*.

To be concrete, we consider a cylinder that initially rolls on an horizontal table covered with a thick flannel (see figure 7a) and comes to a stop. The velocity of the cylinder is measured with a motion sensor and is plotted vs. time (see figure 7b): the observed linearity tells us that the acting *total force* and the *total torque* are constant in time.

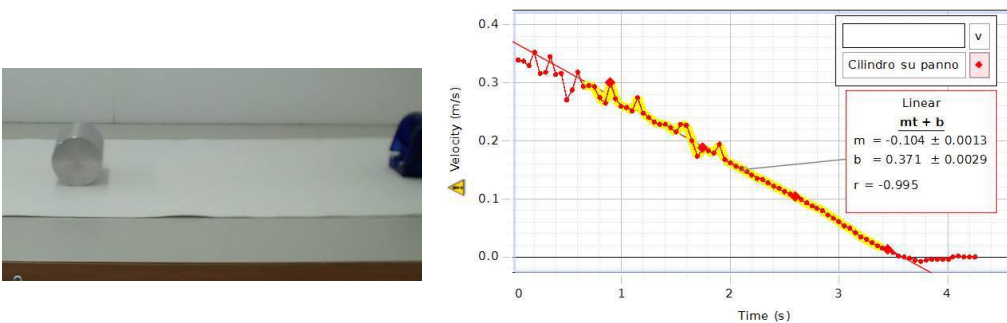

a) b)

Figure 7. Rolling cylinder *with* dissipative process.

Adopting again the same point of view as in the previous section, we can argue that there is an *outgoing flow* of both linear momentum and angular momentum from the cylinder to the surface.

In order to get a quantitative description of the process, we can model the system as follows: we introduce an interaction layer and confine there all the dissipative processes generated by the deformations of both cylinder and surface.

First, we analyse the *mechanical interaction* which is responsible for the exchanges of linear momentum (x-direction) and angular momentum. The two components of the force that describe the interaction between cylinder and surface can be characterized, in terms of the proposed model, as follows (see figure 8a):

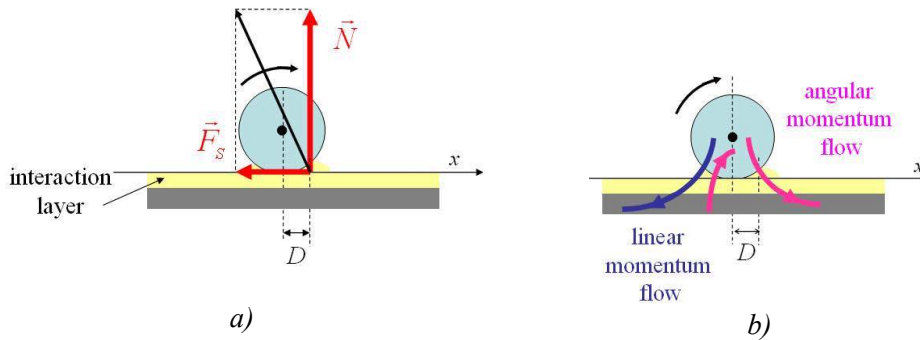

Figure 8. Modelling the dissipative rolling motion.

first, the normal component N that originates the torque that slows down the rotation of the cylinder: from the cylinder there is an *outgoing flow* of angular momentum through the interaction layer to the surface; and *second*, the shear adhesion force F_s that slows down the translation of the cylinder represents an *outgoing flow* of linear momentum *and*, at the *same time*, this force originates a torque that *sustains* (!) the rotation of the cylinder: from the surface there is an *incoming flow* of angular momentum (see figure 8b).

We can examine the situation from a more formal point of view: if we adopt our analysis scheme, from the experimental data (slope of the velocity vs. time, see figure 7b), we can first calculate the *rate of change* of linear momentum and therefore determine the value of the shear adhesion force:

$$\dot{p}_x = F_{x\text{tot}} = F_{xS} < 0. \quad (8)$$

At this point we can combine the equation giving the total torque and our key relation expressing the (dynamical) rolling condition (eq. 6) to get the value of shear force and finally the displacement parameter D :

$$\dot{L} = \tau_{\text{tot}} = \tau_N + \tau_S \quad \text{or explicitly} \quad \frac{1}{2} R F_{xS} = -D N + R |F_{xS}|, \quad (9)$$

$$F_{xS} = -\frac{2 D N}{3 R} \quad \Rightarrow \quad D = \frac{3 |F_{xS}| R}{2 N}. \quad (10)$$

In other words, our analysis allows us to fix *all* the free parameters of the model so that we can account for the observed motion of the cylinder. However, there are still aspects which are worth paying attention to; in particular one may wonder how it is possible that the intensity (strength) of the *outgoing flow* of angular momentum due to the breaking torque is higher than the instantaneous rate of *decrease* of the angular momentum of the cylinder (see equation 9). Let us try to clarify this point within the framework of our model. We represent all this in terms of a *process diagram*³ for the cylinder and separately for the interaction layer (see figure 9).

³ Process diagrams have been discussed and used extensively by Fuchs (chapters 2 and 4) [Fuchs, 2010].

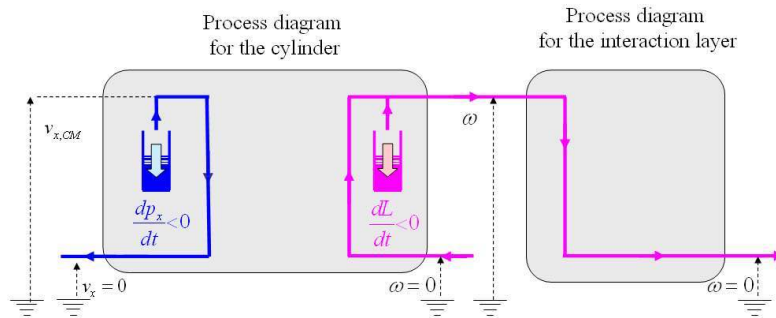

Figure 9. Process diagram for the rolling cylinder in presence of dissipative process: linear momentum and angular momentum exchanges.

Trough the interaction described above, the cylinder gradually releases all its *linear momentum* to the surface: as we'll see in the next section dedicated to the energy exchanges, it is important to notice that this momentum flow, since there is no sliding, leaves the system at the “zero level” of the mechanical potential. In order to clarify the quantitative relation between the angular momentum decrease and the intensity (strength) of the outgoing angular momentum flow, it is crucial to notice that the *outgoing* flow of linear momentum is coupled to an *incoming* flow of angular momentum from the surface to the cylinder: the intensity (strength) of the *outgoing* angular momentum flow is then the sum of the *decreasing rate* of the angular momentum of the cylinder and the intensity (strength) of this *incoming* angular momentum flow. In addition, we notice that the cylinder releases all its *angular momentum* to the surface trough the interaction layer, where we imagine that the dissipative process takes place.

6. Energy

In this last section we just briefly sketch how to incorporate the *energy analysis* into the framework of the proposed approach⁴. Obviously, all the results we are looking for are well known in the standard literature. The discussion of all the examples with a rolling cylinder reminds us that the *energy – work theorem* in the usual form is applicable only to point-like systems (or to systems that don't show any other motion than a rigid translation). This point is discussed in detail, also in the case of rotations and rolling friction, but the proposed solutions seem to us to be rather formal, for example involving the concept of *pseudo-work*, and fails to foster a physical meaning of the process. An interesting and more experimentally based analysis of this point is presented by Borghi *et al.* [Borghi, 2005], where the concept of *frictional torque* is introduced. Their results are fully compatible with ours and can be easily integrated into the more general framework we are discussing here.

The basic idea of our approach is the following: each *energy flow* is always associated to the *flow* of another *extensive physical quantity* (which can be therefore regarded as an *energy carrier*).

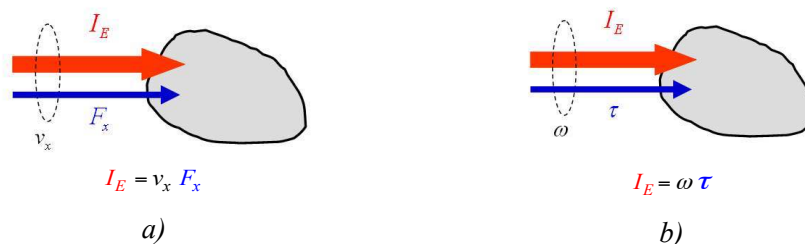

Figure 10. Energy exchanges.

By conductive processes, the level of the *conjugate potential* at which the transport takes place represents the proportionality factor between the intensity (strength) of the energy flow and the intensity (strength) of the flow of the physical quantity to which it is associated in the considered process. For mechanical processes this means that to each linear momentum flow there is an associated energy flow while the velocity plays the role of the potential (see figure 10a), as well that to each angular momentum flow there is an associated energy flow while the angular velocity plays the role of the potential (see figure 10b).

⁴ A more complete discussion on energy exchanges will be presented elsewhere [Corr, 2014].

For the cylinder which is rolling without sliding on the flannel we can now inquire about the energy exchanges. In particular: how can we interpret the rolling condition (that prevents sliding) in connection with the presence of a dissipative process?

Again we try to understand the situation by a *process diagram* (see figure 11): the rolling condition (no sliding) ensures that the *outgoing* flow of linear momentum from the cylinder to the surface does not carry out energy. This flow, passing from the high level (speed of the center of mass) to a lower level (zero velocity of the surface), however, makes some energy free: the released energy is carried on the angular momentum which flows from the surface into the cylinder and serves to *pump* it up to the needed level of angular velocity.

The *dissipative process* takes place in the interaction layer: there the energy release caused by the *outgoing* angular momentum flow is coupled to the uplod of this energy on the produced entropy.

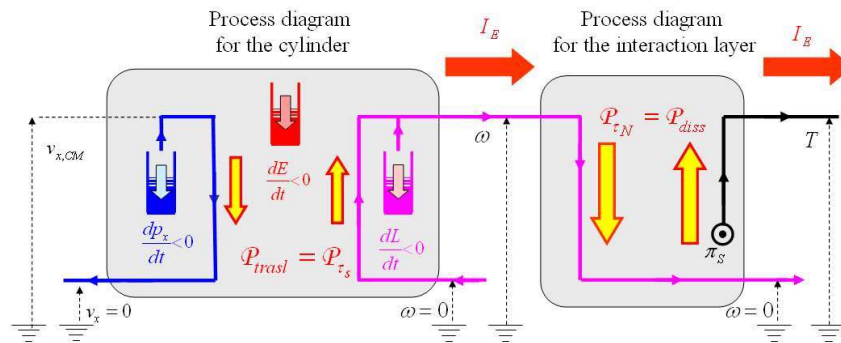

Figure 11. Process diagram for the rolling cylinder in presence of dissipative process: energy.

7. Summary and outlook

With this contribution, starting from an experimental situation, we have introduced a *model* for the description of the *rolling motion* of an object focusing in particular on the exchanges of linear and angular momentum between it and the underlying surface.

This approach, which makes explicit use of *substance metaphors* for some of the basic concepts of physics, represents an example of how productive resources which students are familiar with can assist in teaching and learning, as discussed by Harrer in a recent paper [Harrer, 2013]. From a didactical point of view, obviously, to be successful in the particular subject of mechanical rotations this metaphorical framework should already have been constructed together with the students and referred to consistently from the beginning of their physics lessons: indeed, the same framework can be applied in modeling hydraulic, electrical, thermal or chemical processes.

Our teaching experience at high school level, though limited to a few particularly motivated students who took optional courses based on lab activity, also shows that a deeper insight can be gained using *dynamical modeling*: it offers a powerful tool to complete our analysis and allows us to create quantitative mental maps of the various situations, fixing the quantitative aspects. With this tool students are able to comprehend at a quantitative level not only the examples we considered in this talk, but also those situations in which the acting forces and torques do not have a constant value, such as for a rolling cylinder on a rubber surface.

The outlined model can be easily *extended* also to analyze several experimental situations often discussed in the literature, like the rolling motion of objects with different shape factor K (hollow cylinder, sphere, etc.) on different underlying planes or with different kinds of contact (incline, U-grooved track, etc.), including also *sliding friction* or simple and multiple collisions as well.

References

- Borghi L., De Ambrosis A., Mascheretti P., (2005). Sliding and rolling: the role of friction, in Michelini M., Pugliese Jona S. (Ed), *Physics Teaching and Learning* (p. 133), GIREP Book, Udine: Forum.
- Carnero C., Auiar J., Hierrezuelo J., (1993). The work of the frictional force in rolling motion, *Phys. Educ.*, **28**, 225-227.
- Corridoni T., D'Anna M., Fuchs H.U., (2014). A model for rolling friction as a dissipative process (paper submitted to *The Physics Teacher*).

- Fuchs H.U., (2010). *The Dynamics of Heat - A Unified Approach to Thermodynamics and Heat Transfer*. 2nd edition. New York: Springer.
- Harrer B.W., Flood V.J., Wittmann M.C., (2013). Productive resources in students' ideas about energy: An alternative analysis of Watts' original interview transcripts, *Phys. Rev. STPER*, **9**, 023101.
- Pinto A., M., Fiolhais M., (2001). Rolling cylinder on a horizontal plane, *Phys. Educ.*, **36**, 250-254.
- McClelland J., (1991). Friction and related phenomena, *Phys. Educ.*, **26**, 234-237.
- Salazar A., Sancez-Lavega A., Arriandiaga M.A., (1990). Is frictional force always opposed to the motion?, *Phys. Educ.*, **25**, 82-85.
- Shaw D.E., (1979). Frictional force on rolling objects, *Am. J. Phys.*, **47**, 887-888.

Affiliation and address information

Michele D'Anna
Liceo cantonale di Locarno
Via F. Chiesa 15a
6600 Locarno
Switzerland
e-mail: michele.danna@edu.ti.ch

An Alternative Approach to the Boltzmann Distribution Through the Chemical Potential

Michele D'Anna¹, Georg Job²

¹ Liceo cantonale, Locarno, Switzerland

² Eduard-Job-Stiftung für Thermo- und Stoffdynamik, Hamburg, Germany

Abstract

The Boltzmann distribution is one of the most significant results of classical physics. Despite its importance and its wide range of application, at high school level it is mostly presented without any derivation or link to some basic ideas. In this contribution we present an approach based on the chemical potential that allows to derive it directly from the basic idea of thermodynamical equilibrium.

Keywords

Chemical potential, thermodynamical equilibrium, Boltzmann distribution.

1. Introduction

The Boltzmann distribution, first derived by Maxwell for the velocities of gas molecules at a given temperature, is one of the most important results of the molecular-kinetic approach, which has since become a cornerstone of statistical physics. Despite its historical and cultural relevance, there are only a few attempts to introduce suitably this result in high school teaching. Textbooks generally introduce the Boltzmann distribution without deriving it from some basic ideas, stating only the final result with some pictures that illustrate the situation together with some details about probabilities and mean values. The reason of this situation may be that Boltzmann distribution is considered one of the main results of the theory of statistical physics, and therefore well beyond the reach of secondary school ambitions.

This contribution proposes an alternative approach, which can be traced back to an idea expressed by Einstein in a paper dated July 1914 (what a lucky coincidence for the symposium!) [Einstein, 1914], in which he considered an ideal gas consisting of molecules in different excitation states as an *equilibrium mixture of distinct substances*, each one characterized by its own excitation energy. Moreover, the description of elementary processes of statistical physics as reactions between particles of such substances allows the use of the *chemical potential* and its basic dependence on concentration and excitation energy. In this way, the condition for *thermodynamical equilibrium* makes it possible to derive the Boltzmann distribution.

In the second part we are going to sketch how it is possible to extend this approach to other issues. As an example we'll discuss the *contribution of the vibrations* to the specific heat of bi-atomic gases.

As a conclusion, we shall briefly outline the general validity of this approach, indicating how, introducing the idea of free and occupied states as well as the quantum rules of occupation of energy levels, the same approach will lead to the Fermi-Dirac as well as to the Bose-Einstein distribution.

2. The basic idea: a gas as a mixture of several substances

The basic idea is expressed by A. Einstein in a paper he presented at the session of the German physical society, July 24th, 1914. Taking a gas into consideration, Einstein adopted the following point of view:

"I take the liberty to consider two molecules chemically distinct, i.e. in principle separable by means of semi-permeable walls, if their resonator energies e_s and e_r are different. By doing so I can view the gas that was originally seen as uniform as also a mixture of different gases whose constituents are characterized by different values e_s ."

We generalize this point of view taking into account even the *translational motion* of the molecules as a kind of excitation. For the sake of simplicity, let us consider a dilute monatomic gas, so that the "molecules" can be regarded as pointlike particles as in the Newtonian mechanical model and their *translational kinetic energy* as excitation energy.

To parameterize the velocity of the molecules, we divide the *velocity space* into “cubic cells of volume $[\Delta v]^3$ ”, where each cell centre is identified by a triple of integers (n_x, n_y, n_z) (figure 1):

$$\varepsilon(\vec{v}) = \frac{1}{2} m [v_x^2 + v_y^2 + v_z^2] = \frac{1}{2} m [n_x^2 + n_y^2 + n_z^2] [\Delta v]^2 = \varepsilon_{\vec{n}}. \quad (1)$$

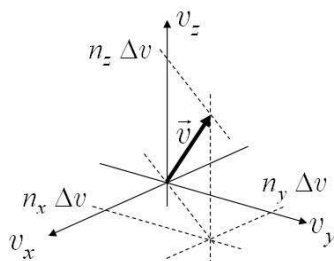

Figure 1. Individuating a cell centre in the velocity space.

In what follows we will refer to the molecules that belong to such a cell as to the \vec{n} -*substance*. Generalizing Einstein’s suggestion, we interpret the physical system “gas” as a mixture of those different gaseous \vec{n} -substances. The kinetic energy of such molecules can be seen as the *excitation energy* of such a partial gas.

3. Chemical potential and equilibrium

With this image in mind, we ask how we can describe the *equilibrium condition* between all these substances. What we need is an *intensive quantity*, which can describe the tendency of one of the substances to transform into other ones. A suitable quantity for this purpose exists, and it is known under the name of *chemical potential* introduced 1876 by Josiah Willard Gibbs [Job, 2006], [Job, 2011].

This quantity accounts for the tendency of a given substance

- to react with other substances forming new ones;
- to transform into another state of aggregation, configuration, etc.;
- to migrate to another place.

Experimental data show that in general the value of the *chemical potential* depends on

- the *kind* and the *state of aggregation* of the substance;
- the physical “milieu” (*temperature, pressure, concentration*);
- the chemical “milieu” (in case of solutions or mixtures: on the kind and on the proportions of the components, on the acidity, etc.).

4. Gas molecules velocity distribution

In order to go further we focus on two points: first, the concentration dependence of the chemical potential, and second the excitation energy that is characteristic for each of the different gaseous \vec{n} -substances. About the first point, we can assume that the gas maintains a constant temperature, so that a model that gives us a convenient description exhibits the usual logarithmic dependence on the concentration:

$$\mu(c) = \mu_0 + RT \ln\left(\frac{c}{c^\circ}\right), \quad (2)$$

where

c° is the reference concentration (1 mol/L);

c is the actual concentration;

μ_0 represents the value of the chemical potential at the temperature T by a gas concentration that equals the chosen reference concentration.

We will refer to this relation as to the *mass action equation*.

The second step allows us to express the excitation equation: the value of chemical potential of the molecules that belong to a particular “ \vec{n} -substance” is obtained by simply adding the molar kinetic energy to the ground value μ_0 :

$$\mu_{0,\vec{n}}^r = \mu_{0,0}^r + N_A \varepsilon_n^r. \quad (3)$$

Since our partial gases all belong to the same *chemical* species, it is *not* necessary to distinguish their μ_0 -values.

We can now express the chemical potential for the \vec{n} -substances by their actual concentration c_n^r :

$$\mu_n^r(c_n^r) = \mu_{0,0}^r + N_A \varepsilon_n^r + RT \ln\left(\frac{c_n^r}{c^\circ}\right) = \mu_{0,0}^r + \frac{1}{2} M v_n^2 + RT \ln\left(\frac{c_n^r}{c^\circ}\right), \quad (4)$$

where M represents the molar mass of the considered gas.

At *equilibrium* the chemical potential of the \vec{n} -substances all possess the same value. This can be expressed by the following relation:

$$\mu_n^r(c_n^{\text{f}q}) = \mu_0^r(c_0^{\text{f}q}), \quad (5)$$

so that we obtain:

$$\mu_{0,0}^r + \frac{1}{2} M v_n^2 + RT \ln\left(\frac{c_n^{\text{f}q}}{c^\circ}\right) = \mu_{0,0}^r + RT \ln\left(\frac{c_0^{\text{f}q}}{c^\circ}\right) \quad (6)$$

or:

$$\ln\left(\frac{c_n^{\text{f}q}}{c_0^{\text{f}q}}\right) = -\frac{M v_n^2}{2RT}. \quad (7)$$

Solving explicitly, we get the final result for *the rates of the equilibrium concentrations*:

$$\frac{c_n^{\text{f}q}}{c_0^{\text{f}q}} = \exp\left(-\frac{M v_n^2}{2RT}\right) = \exp\left(-\frac{m v_n^2}{2 k_B T}\right). \quad (8)$$

This is essentially the Boltzmann distribution of the gas molecules velocities.

An impression of this distribution might be gained by imagining a small amount of gas, possibly about $1 \mu\text{m}^3$, whose particles are allowed to escape into a vacuum by suddenly removing the walls enclosing it. The positions the particles have reached after about $30 \mu\text{s}$ are then marked producing an image as in figure 2. The position reached by a particle simultaneously characterizes the direction and absolute value of the particle's velocity vector \vec{v} .

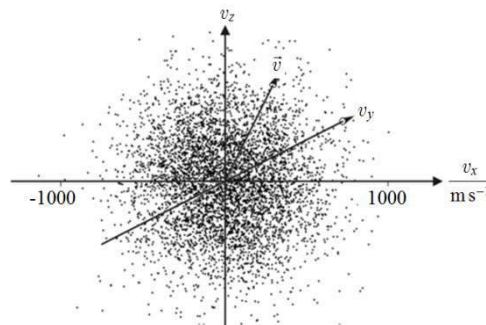

Figure 2. Velocity distribution for nitrogen molecules at 298 K.

We can also plot the relative concentration distribution of the velocities along the v_x -axis: the graphs can be seen as the result of cutting the “cloud” in the velocity space along the v_x -axis for finite velocity intervals (figure 3a) or after performing the limit to infinitesimal intervals (figure 3b), so that we recover the well known Gaussian distribution¹.

¹ Traditionally, for the Boltzmann distribution in books we find another formula than (8) and other pictures than those of figures 3 and 4. In the appendix we will show how to link the two different presentations explicitly.

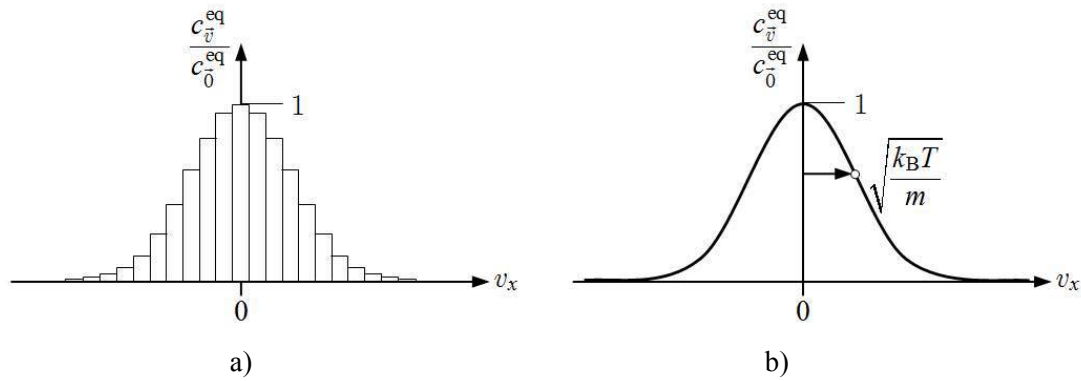

Figure 3. Velocity distribution along the v_x -axis: a) for finite velocity intervals; b) after performing the limit to infinitesimal intervals ($\Delta v \rightarrow 0$): the right inflection point of the bell-shaped curve is marked with a circle (0).

As a concrete example, figure 4 illustrates the situation of nitrogen molecules in the same sample at two temperatures.

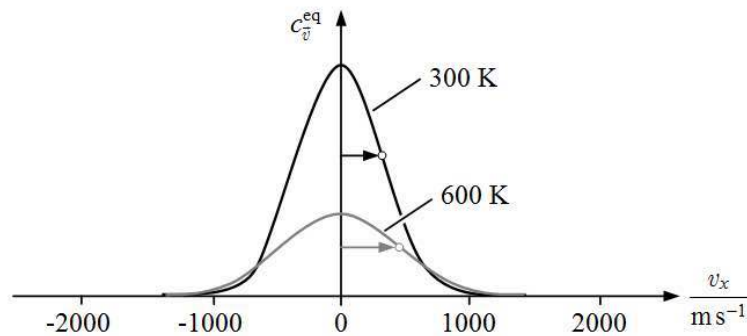

Figure 4. Velocity distribution for N_2 -molecules at different temperatures. The point cloud (figure 2) expands with rising temperature in all three spatial directions proportional to $T^{1/2}$ and the equilibrium concentration of particles with zero velocity decreases correspondingly as $T^{-3/2}$ (provided the velocity interval Δv is small but finite).

5. How could this approach be extended?

Let us now sketch how it is possible to extend this approach. Indeed the previous procedure can be applied to many other systems, provided that the *energy values* and the possible *occupation number* of each excited energy level are properly taken into account.

It is worthwhile to point out that in 1914 Einstein, in connection with the Planck radiation distribution formula, used this approach in order to obtain the well known *average energy* of the 1-dimensional resonator:

$$\bar{\varepsilon} = \frac{h\nu}{e^{h\nu/k_B T} - 1} \quad (9)$$

In what follows we try to make the above statement clearer by discussing the *contribution of the vibrations* to the specific heat of bi-atomic gases [Job, 2007].

Let us consider all the gas particles that are in the same vibrational state with the quantum number j to be molecules of the *substance* $B(j)$. As in the previously example, the entire gas is intended to be an *equilibrium mixture* of such j -substances.

On the basis of the *experimental results*, molecular vibrations can be considered to be approximately harmonic and independent of other kinds of movements of the molecule so that the *excited energy values* of the individual vibrational levels are assumed to form the well known harmonic spectrum:

$$\varepsilon(j) = h\nu \cdot j \quad (10)$$

where the quantity $h\nu$ represents the energy interval between two neighborly excited energy levels. As long as this approximation is valid, the *excitation equation* gives us the chemical potential of the individual substance $B(j)$:

$$\mu_0(j) = \mu_0(0) + N_A h\nu \cdot j \quad \text{for } j = 0, 1, 2, 3, \dots \quad (11)$$

In this way, taking into account the concentration dependence, i.e. the *mass action equation*, we can express the chemical potential for the j -substance at the $c(j)$ concentration:

$$\mu(j) = \mu_0(0) + N_A h\nu \cdot j + RT \ln\left(\frac{c(j)}{c^\circ}\right) \quad \text{for } j = 0, 1, 2, 3, \dots \quad (12)$$

Again, *at equilibrium*, the value reached by all the chemical potentials of the j -substances is the same:

$$\mu^{\text{eq}}(j) = \mu^{\text{eq}}(0) = \mu^{\text{eq}}, \quad (13a)$$

or explicitly:

$$\mu_0(0) + N_A h\nu \cdot j + RT \ln\left(\frac{c^{\text{eq}}(j)}{c^\circ}\right) = \mu_0(0) + RT \ln\left(\frac{c^{\text{eq}}(0)}{c^\circ}\right), \quad (13b)$$

so that, with a little algebra, the different j -concentrations can be calculated:

$$c^{\text{eq}}(j) = c^{\text{eq}}(0) \left[\exp\left(-\frac{h\nu}{k_B T}\right) \right]^j = c^{\text{eq}}(0) q^j, \quad (14a)$$

where:

$$c^{\text{eq}}(0) = c^\circ \exp\left(\frac{\mu^{\text{eq}} - \mu_0(0)}{RT}\right) \quad \text{and} \quad q = \exp\left(-\frac{h\nu}{k_B T}\right) < 1. \quad (14b)$$

Since the sum of all these values must correspond to the *actual* concentration of the gas, we obtain a relation between the partial concentrations $c(j)$ and the actual gas concentration c .

$$c = \sum_j c^{\text{eq}}(j). \quad (15)$$

With the well known property of the *geometrical series* we obtain in this way a relation between the actual gas concentration, the chemical potential and the temperature:

$$c = \sum_j c^{\text{eq}}(j) = c^{\text{eq}}(0) \sum_j q^j = c^{\text{eq}}(0) \frac{1}{1-q} = c^\circ \exp\left(\frac{\mu^{\text{eq}} - \mu_0(0)}{RT}\right) \cdot \frac{1}{1 - e^{-h\nu/k_B T}}. \quad (16)$$

Notice that the last term in the last equation is nothing else than the vibrational *partition function* of the 1-dimensional harmonic oscillator.

Recalling further that the value of the chemical potential $\mu(c)$ of the *gas* must obviously coincide with the one assumed at *equilibrium* by each of the individual j -substances:

$$\mu(c) = \mu^{\text{eq}}, \quad (17)$$

relation (16) then shows us how to get the *chemical potential* of the gas at this concentration c . Solving for $\mu(c)$, we obtain:

$$\mu(c) = \mu_0(0) + RT \ln\left(\frac{c}{c^\circ}\right) + \underbrace{RT \ln\left(\frac{1 - e^{-h\nu/k_B T}}{1 - 442443}\right)}_{\mu_{\text{vib}}}. \quad (18)$$

where the last term μ_{vib} represents the contribution of vibrations to the chemical potential: it is interesting to note that this term depends on temperature T but is independent from both concentration c and pressure p .

This result provides us with the answer to our initial question: indeed, from the thermodynamics we know that the *first derivative* of the chemical potential with respect to the temperature at constant pressure yields the *molar entropy* S_m :

$$S_m = -\left(\frac{\partial \mu}{\partial T}\right)_p, \quad (19)$$

while the *second derivative* of the chemical potential with respect to the temperature, again at constant pressure, yields *molar heat capacity* $C_{p,m}$:

$$C_{p,m} = -T \left(\frac{\partial^2 \mu}{\partial T^2} \right)_p. \quad (20)$$

Without discussing the details of the calculation, we just indicate here the final result for the contribution of vibrations to the molar heat capacity of bi-atomic gases:

$$C_{\text{vib}} = -T \frac{\partial^2 \mu_{\text{vib}}}{\partial T^2} = R \frac{[h\nu / k_B T]^2 e^{h\nu/k_B T}}{[e^{h\nu/k_B T} - 1]^2}. \quad (21)$$

The example in figure 5 refers to the I_2 -vapour. The *characteristic temperature of vibration* can be determined from spectroscopic measurements:

$$T_{\text{vib}} = h\nu / k_B = 305 \text{ K}. \quad (22)$$

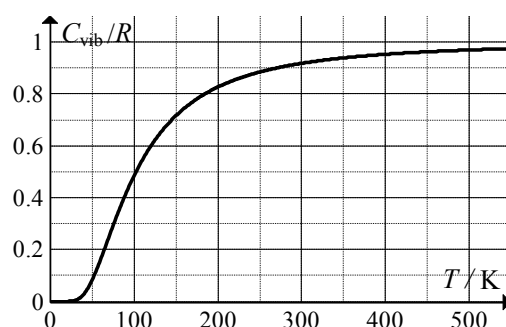

Figure 5. The contribution of molecular vibrations to the molar heat capacity of I_2 -vapour.

6. Conclusion and outlook

In this paper we have proposed an alternative approach to introduce the *Boltzmann distribution* based on general ideas that students meet in other contexts of science. Starting from:

- the concept of the *chemical potential*,
- the *mass action law*,
- the *excitation equation*,
- the *equilibrium condition*

students are indeed no longer just faced, as is usually the case in textbooks, with the final result and some typical pictures based on probabilities and mean values, but deduce from the Boltzmann distribution extending coherently to statistical physics problems a kind of modeling valid for hydraulic, mechanical, electrical, thermal or chemical processes. Moreover, they could test the theoretical results experimentally, as we show, calculating the vibrational contribution to the *heat capacity* for bi-atomic gases.

The *same approach* can be applied in order to discuss quantitatively many other issues, such as the Planck radiation formula, the barometric formula, the sedimentation in a centrifuge, the contribution to heat capacity for poly-atomic molecules (vibrational and rotational), some simple nuclear reactions, redox and acid-base reactions, etc. [Job, 2007].

Furthermore, if we look at states of a system as *sites* that can be free or occupied, this approach allows us to discuss also the Debye T^3 -law, the single or multi-layer adsorption, the electron gas in metals and semi-conductors, the Fermi-Dirac and Bose-Einstein distribution and gas degeneration, and many, many other questions.

Appendix

Equation (A1) shows us a typical formulation of the Maxwell-Boltzmann distribution of the *speed* v of the molecules:

$$df(v) = 4\pi \left[\frac{m}{2\pi k_B T} \right]^{3/2} \exp\left(-\frac{mv^2}{2k_B T}\right) v^2 dv, \quad (\text{A1})$$

where $f(v)$ is the fraction of all molecules with a speed smaller than v . Figure 6 reports typical illustrations we generally find in books: on the left we see the temperature dependence, while on the right we have the result for different molecular masses.

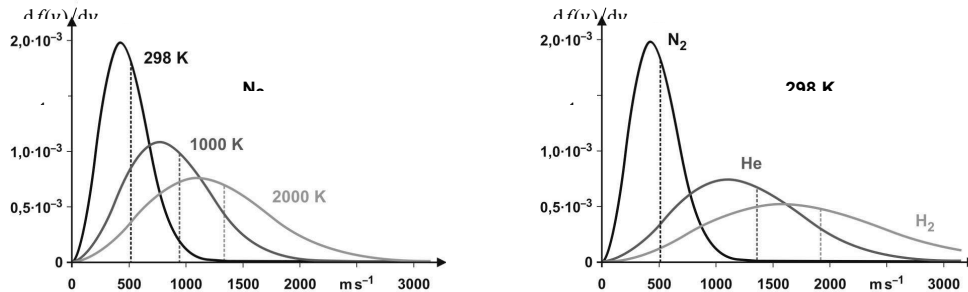

Figure 6. Usual illustration to the Maxwell-Boltzmann distribution of the *speed* of the gas molecules.

They look very different from those we have discussed and perhaps it is worthwhile to link the previous formulation to these ones. This is achieved when we look for the fraction of particles $df(v)$ having the absolute value of the velocity within a spherical shell of radius v and thickness dv (figure 7).

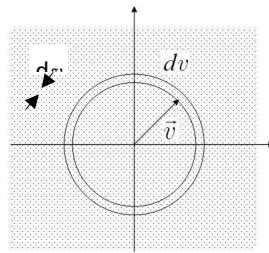

Figure 7. Spherical shell in the velocity space (2-dimensional representation).

$df(v)$ is proportional to both the „volume“ $4\pi v^2 dv$ of the shell *and* to the concentrations $c(v)$ of the partial gases that belong to this shell. $c(v)$ is the same function for all our \vec{n} -substances. Indicating with γ the proportionality factor, we get:

$$df(v) = \gamma c(v) 4\pi v^2 dv. \quad (\text{A2})$$

Inserting the result of equation (8) we then find:

$$df(v) = \gamma c(0) \exp\left(-\frac{mv^2}{2k_B T}\right) 4\pi v^2 dv. \quad (\text{A3})$$

Obviously, the integration of all the contributions $df(v)$ from $v = 0$ to ∞ gives 1, so that:

$$1 = \int dN(v) = \gamma 4\pi c(0) \int_0^{\infty} \exp\left(-\frac{mv^2}{2k_B T}\right) v^2 dv = \gamma c(0) \left[\frac{2\pi k_B T}{m} \right]^{3/2}, \quad (\text{A4})$$

while for the last equality we used the well-known result:

$$\int_0^{\infty} x^2 \exp(-ax^2) dx = \frac{\sqrt{\pi}}{4} a^{-3/2}. \quad (\text{A5})$$

After getting $\gamma c(0)$ as:

$$\gamma c(0) = \left[\frac{m}{2\pi k_B T} \right]^{3/2}, \quad (\text{A6})$$

we then find the relation (A1) we are looking for.

References

- Einstein A., (1914). Beiträge zur Quantentheorie, *Verh. Deut. Phys. Gesell.* **XVI**, 820–827 (see also: Contributions to Quantum Theory, in *The Collected Papers of Albert Einstein*, 1997, **6**, Princeton University Press, 20–26).
- Job G., Herrmann F., (2006). Chemical potential - A quantity in search of recognition, *Eur. J. Phys.*, **27**, 1–19.
- Job G., (2007). *An Elementary Approach to Quantum Statistical Problems*, Eduard-Job Foundation preprint (the paper can be requested at sekretariat@job-stiftung.de).
- Job G., Rüffler R., (2011). *Physikalische Chemie*, Wiesbaden: Vieweg+Teubner (english edition: *Physical Chemistry from a Different Angle*, Springer, 2015, in preparation).

Affiliation and address information

Michele D'Anna
Liceo cantonale di Locarno
Via F. Chiesa 15a
6600 Locarno - Switzerland
michele.danna@edu.ti.ch

Georg Job
Eduard-Job-Stiftung für Thermo- und Stoffdynamik
An der Strusbek 5
22926 Ahrensburg (Hamburg) - Deutschland
georg.job@job-stiftung.de

Implementation of a Proposal to Teach Quantum Mechanics Concepts from Feynman's Multiple Paths Applied to the Light

María De Los Ángeles Fanaro^{1,2}, María Rita Otero^{1,2}, Mariana Elgue¹

¹ *Núcleo de Investigación en Enseñanza de las Ciencias y la Tecnología (NIECyT)
Facultad de Ciencias Exactas- Universidad Nacional del Centro de la Provincia
de Buenos Aires (UNCPBA)*

² *Consejo Nacional de Investigaciones Científicas y Técnicas (CONICET).
Argentina*

Abstract

The questions in a didactic sequence for teaching different aspects of the light in a unified framework and in an unconventional way are presented in this work. The objectives to be attained by each question are also described hereafter. Then, the focus is set on the analysis of the double slit experience with light by using concepts of the Feynman method of "Multiple Paths" in quantum mechanics. The advantages of this formulation for the teaching of basic aspects of quantum mechanics in secondary school education are analyzed.

Keywords

Reflexion, refraction, Double slit experience, light, Feynman's Multiple Paths

1. Introduction

The behaviour of matter and light cannot be well described exclusively by the classical notions of particle and wave, but from the model provided by quantum physics. For the case of electrons and subatomic particles, Feynman's Multiple Paths offer an alternative approach that allow a meaningful study of the concepts of probability, superposition principle and correspondence principle, showing the fundamental and universal character of quantum mechanics laws (Arlego, 2008; Fanaro, Otero & Arlego, 2009; Fanaro, Arlego & Otero, 2014).

In previous research a sequence of situations adapting Feynman's approach was constructed and implemented in secondary school for teaching electron behaviour. (Fanaro, Otero & Arlego, 2009, 2012). In the case of the light, an alternative approach to the usual presentation of light quantization in textbooks for teaching is proposed as applying the Feynman model (Arlego, Fanaro & Otero, 2013; Elgue, Fanaro, Arlego & Otero, 2011).

The double slit experience is usually used to explain and demonstrate the wave behaviour of light, using the concepts of wavelength, optical path difference, interference and diffraction. This way of presenting and analyzing the experience aims at establishing the wave nature of electromagnetic radiation. Identifying light with a wave or with a particle is physically inappropriate because neither the corpuscular nor the wave model, or a combination of both, offer a complete description of the behaviour of light in all energy and size scales. This does not mean that the classical concepts of wave and particle are completely discarded in the description of quantum phenomena. The behaviour of a quantum objects, such as the electron or the photon, depends on the experimental setup with which they interact. For instance, in the double-slit experiment, light exhibits wave behaviour when interacting with the double slit, though it is detected as a particle as localized on the screen. This duality is a manifestation of the *principle of complementarity* introduced by Bohr, in the framework of standard interpretation of quantum mechanics and having its root in the principle of uncertainty. In quantum theory, corpuscular and wave-like points of view are complementary rather than contradictory (Fanaro, Arlego & Otero, 2014)

In the present work, the proposal is to perform the study of the behaviour of light from a perspective that shows the general character of quantum mechanics and describes the results of the double slit experience in terms of the "Feynman's Multiple Paths" approach. This method is adapted to the students' mathematical level by using concepts such as the sum of vectors and trigonometric functions. In that context, the application of the technique is showed in detail by using simulations done with the Geogebra® software. In particular, the probability of simple event detections of light and the distribution of light on the screen in the

double slit experience is evaluated. Unlike other approaches which are based on the Feynman method (Ogborn, Hanc and Taylor, 2006; Hanc and Tuleja, 2005; Taylor, Vokos, O'Meara and Thornber, 1998), the word "photon" is not mentioned in the present case. Moreover, questions of the type "What is light?" are avoided, as the focus of the study is set on the predictive character of the laws and not on its epistemological aspects.

2. Method

In the first place, the concepts were analysed and structured to teaching as based on Feynman's technique, and then the didactic sequence was elaborated. The material was used in four Physics courses at senior-level high school. The classes were composed of 20-25 students aged 16-17 years old. There were two one-hour-long classes per week. The instructional sequence consisted of a set of lessons divided into four stages as described in the following section. In the implementations, the general conversations on each situation were recorded in audio and then transcribed, including all the paper resolutions performed by the students (problem solving, drawings, personal synthesis, written test, etc.). From these registers, the obstacles and the way in which the sequence worked out could be analyzed.

3. The didactic sequence

The key aspect in this didactic viewpoint is the starting by presenting questions to the students. The situations elaborated at this point required students to imagine, perform experiments, develop conjectures, and answer questions.

The didactic sequence was carried out starting from the experiences of reflection, refraction and the double slit experiment. These experiences were performed in the classroom using mirrors and a graduated circle specially designed to analyze the reflection and refraction, a container and different liquids for the refraction, and a metallized sheet designed with two thin slits. In all of them a common laser light was used. The three experiences were carried out by the students and the experimental results were successfully described by them afterwards. Following this, the double-slit-experience results with very low light intensity showing individual detections were presented through a sequence of real images of the double slit experiment. These images -taken from the web- support the idea of the individual detection events and the light hitting the screen in a granular way. At the beginning, individual events seem to be distributed randomly over the screen. But as time elapses, a pattern of maxima and minima is formed on the screen. In this case the light exhibits a different behaviour from previous experiences: showing a particle-like aspect in the detection of individual events on the screen, and also a wave-like aspect in the concentration fringes formed on the screen, like in the experience performed in the classroom. The concept of discrete detection was highlighted in this part.

An explanatory model of all these experiences was proposed: the laws of quantum mechanics for light using Feynman's path integrals technique were adapted to the mathematical level of the students. Graphic representations and basic operations with vectors, which captured the essential aspects of the theory, were used. A simulation made with the GeoGebra^(R) software helped students to visualize the results of the "Feynman's Multiple Paths" technique applied to a simple case of emission and detection of light. The concepts of probability and minimum time were highlighted in this part. Then, these results were applied to the double slit experience to explain the results presented in the previous situation in relation to the granular detection and successive fringes of concentration.

Finally, the technique to consider alternative paths was applied to the reflection and refraction of light by using GeoGebra^(R) simulations. The students noticed that the results approximated to those observed in previous experiences and therefore reached the conclusion that the laws of quantum mechanics can describe the observed phenomena.

As follows, the questions posed to the students are presented hereafter together with the feasible conclusions for each question.

Stage 1- Four experiences to study light reflection, refraction and the double slit experience

Situation 1.1 – Studying the reflection

The students were presented with the following question: Considering that we want to look at a flat mirror which stands vertically and perpendicularly to the floor, trying to see all our body in it. What should the minimum size of the mirror be and how should it be placed?

Then, the students were asked to perform the experience in the classroom as Figure 1 shows.

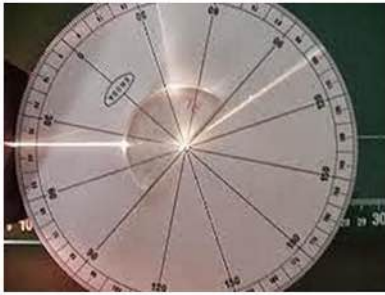

Figure 1: Reflection experience performed in class

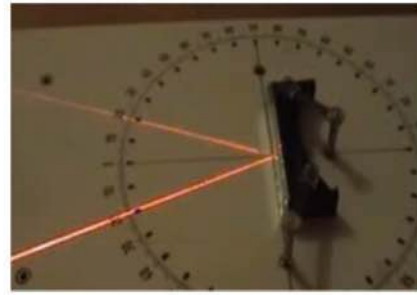

Figure 2: Refraction experience performed in class

The aim of this activity was that students concluded the following: “When light falls upon a flat mirror it is fully reflected causing that the angle of reflection is equal to the angle of incidence”

Situation 1.2 - Studying the refraction

The students were asked: How do we perceive a pencil or a spoon that is partially submerged in a glass of water or oil?

Afterwards, the classroom experience was performed similarly to Figure 2.

The aim was to reach the following conclusion: “The direction of the incident light changes when the light goes through a surface”.

Situation 1.3 - Studying the Double Slit Experience (DSE) with laser light

A scheme of the Double Slit Experience was presented (Fig. 3 Left) and the students were asked: Can you imagine the light distribution in the screen?

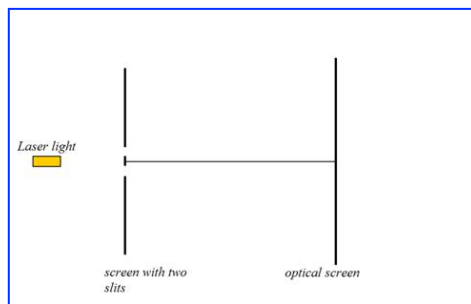

Figure 3. Left: The scheme of the Double Slit Experience presented to the students

Right: Picture of the resulting pattern obtained in a typical double slit experiment with a red laser.

Then, the group performed the double slit experience in the classroom in a simple way by using a metallized sheet with two thin slits. The source of light was a red laser pointer. On the detection screen, a characteristic pattern of alternated light and dark fringes was formed, as it is showed in Figure 3 (right). The objective was to establish the following idea “when arrangement of fringes is produced; it is called interference pattern”.

Even though the resulting pattern is interesting in itself, its formation, i.e., the way in which the distribution evolves in time until the stationary pattern is obtained results intriguing. Then the temporal evolution of the pattern is analysed in the next situation referred to the double slit experience (DSE) done with a “special detection system”. This denomination has been chosen because this experience must be differentiated from the experience made in class, but avoiding any reference to the concepts of photon and laser intensity.

So we presented to the students the results of the double slit experience made in a real laboratory (not in classroom) and we also noted that in this case a special laser and a large number of light sensitive detectors, which are able to record in real time the detections, were used. Due is technologically impossible to make this experience in the classroom, the results (available on the internet) provided to the students are an accessible alternative to visualize the formation of the interference pattern.

Situation 1.4 – Analyzing images of the double slit experience (DSE) done with a “special detection system”

The results of the double slit experience showing individual detections were presented to the students as shown in Figure 4¹ which contains a sequence of real images of the double slit experiment with very low light intensity:

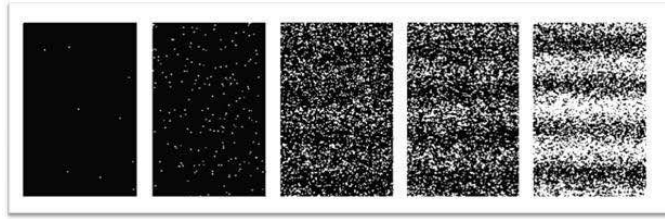

Figure 4: Snapshots at increasing times (left to right) of detection screen in a double slit experiment with very low intensity of light.

Using these snapshots is possible to discuss with the students the individual detection events, and the light hitting the screen in a granular way. First, the individual events seem to be distributed randomly over the screen. However, as time elapses, a pattern of maxima and minima is formed on the screen. Then the question given to the students was: How can these results be described?

In consequence, students are able to state that *in this case the light exhibits a different behaviour from previous experiences*: showing a particle-like aspect in the detection of individual events on the screen, and also a wave-like aspect in the concentration fringes formed on the screen, like in the experience performed in the classroom. The concept of discrete detection can be highlighted in this part of the work.

The aim of the activity was to analyze the way in which quantum mechanics can predict the alternated pattern observed in the double slit experiment. From a quantum point of view, the question is: What is the probability of detecting the source-emitted light at a given point of the detection screen? In the following stage this question is presented and discussed.

Stage 2- The quantum model of light: the Sum over All Paths' (SAP) technique² for probability calculus

After analyzing the four previous experiences the students were asked the following: *How can the results of all the previous experiences be explained and confirmed from a unique model?*

An explanatory model of all these experiences was proposed: the laws of quantum mechanics for light using Feynman's path integrals technique and adapted to the mathematical level of the students. Graphic representations and basic operations with vectors which capture the essential aspects of the theory were used. A simulation using GeoGebra^(R) software was constructed. It provided the students with an aid to visualize the results of the "Sum over All Paths" technique applied to a simple case of emission and detection of light, as follows:

Situation 2.1- Presentation and analysis of Sum over All Paths' (SAP) technique for probability calculus

The technique was presented to the students in order to determine the probability of detecting light at F that was emitted at I, as follows:

1) Consider different paths connecting I with F. Figure 5 shows some of them (A, B, C, D, E, F and G)

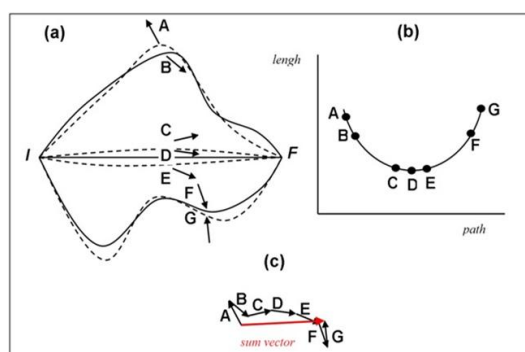

Figure 5: (a) Some paths connecting I with F, and their associated vectors ; (b) Representation of the path length for different "paths" ; (c) Sum of the associated vectors

¹Image obtained from http://es.wikipedia.org/wiki/Experimento_de_Young.

² The Feynman's Multiple Paths approach is called Sum over All Paths' (SAP) technique with the students

- 2) Associate a unitary vector to each path in the plane, whose direction is proportional to the length of the light path (L). The proportionality constant depends on the "type" of light (red, green, infrared, etc.): **angle** $\sim k \cdot L$
- 3) Add the vectors corresponding to all the paths in order to obtain the resultant vector, as shown schematically in the Figure 5c.
- 4) The squared length of the resultant vector is proportional to the probability of detecting at point F the light emitted at I.

Situation 2.2 Study contributions to the sum of the vectors with the simulation performed with GeoGebra®

In order to visualize the general procedure and the contributions of different paths, a simulation performed with the Geogebra ® software was presented:

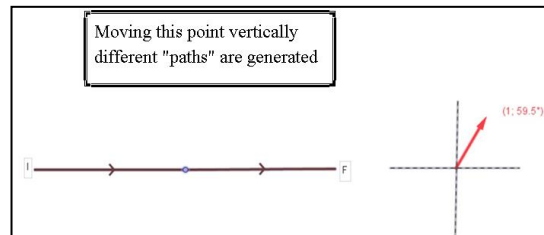

Figure 6: Screen shot of a simulation performed with Geogebra®, showing simultaneously a path and its associated vector (length= l ; angle= $\omega d / c$). The middle point between I and F can be moved vertically to generate different "paths"

The concepts of probability and minimum time were highlighted in this part. Then, these results were applied to the double slit experience as a means to explain the results noticed in the previous situation in connection with granular detection and successive fringes of concentration.

Stage 3: Light reflection and refraction from Feynman's model (SAP)

The technique to consider alternative paths was applied to the reflection and refraction of light, using simulations made with GeoGebra®. The students noticed that the results approximated to those observed in previous experiences. Thus, it is possible to conclude that the laws of quantum mechanics can describe the observed phenomena.

The questions given to the students for both reflection and refraction were: How is vector contribution interpreted in terms of probabilities? How does the result obtained by adding the vectors relate with the law of reflection studied in the first experiment?

For each experience, the students can be aided by the simulations made with GeoGebra® in order to arrive at the following conclusions:

The most probable path for the light is the shortest, i.e. that the incidence angle is equal to reflection angle (reflection law);

The most probable path for the light is that for which the time is minimum, in the reflection and refraction too.

Finally, the students were asked to reconsider the double slit experience presented in the image in Fig.4 and to analyze the following: *What is the probability of light detection at x ?*

This question can be responded by means of the procedure established in Stage 2. To this end, the scheme of Figure 7 is presented to the students. In this graphic, the source (not shown) is expected to be placed on the left side of the double slit screen and, the detection screen is placed at a long distance from the slits. Also, the detection point is at a distance x on the right screen (measured from its centre).

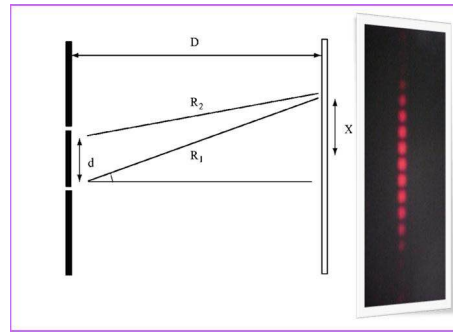

Figure 7: Scheme of the double slit experience.

As it can be observed in Figure 7, two direct paths connecting the source with a given point x on the screen are being considered. One of the paths passes through the lower slit, while the other goes across the upper slit. But there are many alternatives, in principle infinite, of connecting the source with the detection point. One option could be, for instance, a completely arbitrary path connecting the source to one of the slits, and from there to the detection screen. However, according to previous discussion, the shortest path and its environment are the most important alternatives, and ultimately only these paths will be considered. Hence, the vectors that contribute to the probability are those identified with the direct paths, that is to say, one for each slit, and a finite set (n) of vectors associated with neighbouring paths, which contribute essentially with the same angle (in phase). Therefore, for the first slit:

$$\vec{V}_1(r_1, x) = n \left(1; \omega \frac{d}{c} \right),$$

where ω is proportionality constant³ and R_1 is the distance from the slit 1 to x (see Fig. 7). In Cartesian coordinates, which are more familiar to students the expression is

$$\vec{v}_1(r_1, x) = n \left[\cos\left(\frac{\omega}{c} R_1\right); \sin\left(\frac{\omega}{c} R_1\right) \right].$$

Analogously for the other slit

$$\vec{v}_2(r_2, x) = n \left[\cos\left(\frac{\omega}{c} R_2\right); \sin\left(\frac{\omega}{c} R_2\right) \right].$$

Performing the sum of these two vectors and squaring the result, the following expression for the probability of detection of light at distance x from the centre of the screen results in:

$$P(x) \approx \cos^2 \left(\frac{kR_2 - kR_1}{2} \right) \quad (1)$$

where $k = \frac{\omega}{c}$. In the experimental setup $D \gg d$ and therefore $R_2 - R_1 = \frac{x}{D} d$ is a good approximation, which allows writing Eq. (1) in terms of x as follows:

$$P(x) \approx \cos^2 \left(\frac{\omega d}{cD} x \right) \quad (2)$$

This expression gives the probability of detecting light as emitted from the source at a distance x from the centre of the screen. It is a result derived purely from quantum mechanics, and indicates that the probability function have maxima and minima, in agreement with the alternation pattern observed in the experiment. In this way, students can compare the theoretical prediction with the results of the double slit experience carried out in the classroom. The expression (2) allows analyzing the dependence of the probability on the colour of the light, which was initially set in red. For instance, when using blue light in the experience, students may notice that the maxima are closer to each other and this is indeed what the probability function predicts, where now the value of k is larger, and therefore the argument of the function is also larger. Another possibility would be to fix the colour and analyze the probability dependence on slits separation. It is clear

³ ω is the angular frequency of the corresponding classical electromagnetic wave. However, the use of this terminology is avoided with students since the aim is to conceptualize the light from a quantum point of view, bypassing classical Maxwell electromagnetism.

that working with the parameters of the expression can be a very enriching experience for the conceptualization of students.

Stage 4: The Double Slit Experience from the quantum viewpoint

The following questions were provided to the students: What characteristics have the $P(x)$ graph? How does probability with x distance to the center of the screen change? Considering the previous E_c (2) D (distance from the slits to the wall) and d (distance between slits) and the value of the proportionality constant k , which corresponds to the red laser which is $k= 430.10^{12}(s^{-1})$ the students can draw a graphic $P(x)$, that is a positive and periodical function.

The experimental results can be only represented in an approximate way, given that the true curve is modulated as shown in Figure 8.

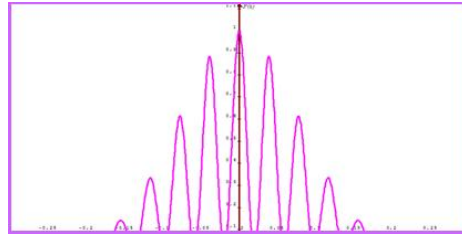

Figure 8: $P(x)$ graph from according to the experimental requirements established

Therefore, the graphic displays peaks that do not have the same height, so the fringes are not equally concentrated, as shown by experimental observation. The discussion with students about the approximation obtained can be very helpful for conceptualization.

The aim of this discussion is that students reached the conclusion that *It is possible to observe the harmonic variation of the probability as a function of the distance to the centre of the screen, and it explains the maxima and minima of the detections observed.*

4. Conclusions

This sequence of situations was implemented in four courses of secondary school. The technique adapted from Feynman's method to consider alternative paths was applied to the reflection and refraction of light, and to the double slit experience using simulations made with GeoGebra(R). The purpose is that the students can notice that the results derived from Feynman's method approximated to those observed in the analyzed and performed experiences. Thus, they can reach to the conclusion that the laws of quantum mechanics are general and allow the description of the observed phenomena successfully.

It is possible to anticipate that the sequence was viable because the students were able to establish the principles and the basic ideas of quantum mechanics. The analysis of the conceptualization of each situation is in progress, and it will give true knowledge of the viability of the sequence.

References

- Arlego, M. (2008). *Revista Electrónica de Investigación en Educación en Ciencias* 3, 59
- Arlego, M. Fanaro M. and Otero, M.R. (2013) *Proceedings of World Conference on Physics Education*, Istanbul, 2012, edited by Mehmet Fath Taşar (Pegem Academi, Istanbul, 2013), p. 795.
- Elgue, M. Fanaro M., Arlego M. and Otero, M.R. (2011) Enseñar el comportamiento de la luz en la escuela secundaria desde una visión actual utilizando el método de caminos múltiples de Feynman. *Actas del I Congreso Internacional en Enseñanza de las Ciencias y la Matemática - II Encuentro Nacional en Enseñanza de la Matemática*, Tandil, 2011. p. 643.
- Fanaro, M. Arlego, M y Otero M. R. (2014) The double slit experience with light from the point of view of Feynman's sum of multiple paths *Revista Brasileira de Ensino de Física* 3 (2)

Fanaro, M. Otero M. and Arlego, A. (2012) A proposal to teach the light at secondary school from the Feynman method *Problems of Education in the 21st Century* 472, 27

Fanaro, M. Otero M.R and Arlego, M. (2009). Teaching the foundations of quantum mechanics in secondary school: a proposed conceptual structure *Investigações em Ensino de Ciências* 14, 37

Fanaro, M. Otero M.R and Arlego, M. (2012) Teaching Basic Quantum Mechanics in Secondary School Using Concepts of Feynman's Path Integrals Method. *The Physics Teacher* 50, 156

Hanc J. and Tuleja, S. (2005) The Feynman Quantum Mechanics with the help of Java applets and physlets in Slovakia. *Proceedings 10th Workshop on Multimedia in Physics* (Freie Universität Berlin, 2005), p. 10.

Ogborn, J. Hanc, J. and Taylor, E. (2006) Action on Stage: Historical Introduction *Proceedings The Girep conference 2006, Modeling in Physics and Physics Education* (AMSTEL Institute, Amsterdam, 2006), p. 213.

Taylor, E.F. Vokos, S. O'Meara J.M. and Thornber, N.S. (1998). Teaching Feynman's sum-over-paths quantum theory *Computers in Physics* 12, 190

Affiliation and address information

María de los Ángeles Fanaro

Núcleo de Investigación en Enseñanza de las Ciencias y la Tecnología (NIECyT)

Consejo Nacional de Investigaciones Científicas y Técnicas (CONICET). Argentina

Universidad Nacional del Centro de la Provincia de Buenos Aires

Facultad de Ciencias Exactas

Pinto 399. Tandil, Provincia de Buenos Aires

Argentina

e-mail: mfanaro@exa.unicen.edu.ar

María Rita Otero

Núcleo de Investigación en Enseñanza de las Ciencias y la Tecnología (NIECyT)

Consejo Nacional de Investigaciones Científicas y Técnicas (CONICET). Argentina

Universidad Nacional del Centro de la Provincia de Buenos Aires

Facultad de Ciencias Exactas

Pinto 399. Tandil, Provincia de Buenos Aires

Argentina

e-mail: rotero@exa.unicen.edu.ar

Mariana Elgue

Núcleo de Investigación en Enseñanza de las Ciencias y la Tecnología (NIECyT)

Consejo Nacional de Investigaciones Científicas y Técnicas (CONICET). Argentina

Universidad Nacional del Centro de la Provincia de Buenos Aires

Facultad de Ciencias Exactas

Pinto 399. Tandil, Provincia de Buenos Aires

Argentina

e-mail: marianaelgue@hotmail.com

Secondary Students' Views about Scientific Inquiry

Silvia Galano, Alessandro Zappia, Luigi Smaldone, Italo Testa
Department of Physics, University Federico II, Naples

Abstract

In this study we investigated the views about Scientific Inquiry (SI) of about 300 students at the beginning of the secondary school course (14-15 years old). An adapted version of the Views On Scientific Inquiry (VOSI) questionnaire was used as research instrument. The questionnaire, focused on six specific aspects of SI, was submitted before and after a six-hours in-classroom delivery of a teaching-learning sequence that targeted explicitly the six SI aspects. We first analyzed responses using a five-level categorization: a) informed view; b) mixed or partially correct view; c) naïve view; d) unclear; e) not given. Two independent researchers iteratively analyzed the data with a final inter-rater reliability of about 90%. Then, we collapsed the initial categories into three macro-categories: C1) informed/partial view; C2) naïve view; C3) unclear or not given; and calculated the shift in the macro-categorization between pre- and post-test. Finally, we investigated a possible relationship between how the TLSs were enacted and the students' achievements. Data show that the percentage of students' informed responses only slightly increased between pre- and post-test in the majority of the targeted aspects. Moreover, students' achievements seem to depend on how the teachers enacted the TLSs. Our results suggest that short inquiry-based teaching interventions are not sufficient to effectively teach SI aspects. Moreover, our results suggest to develop specific training courses aimed at improving teachers' own beliefs and practices about SI.

Keywords

Nature of Scientific Inquiry; Pre-post design; Qualitative research

1. Introduction and aims

Scientific Inquiry (SI) has been since long time acknowledged as a teaching methodology which can promote a meaningful understanding of concepts (science 'facts') through active investigation of phenomena and processes, measurement, classification, experimentation, data analysis and drawing of reasonable conclusions (Novak & Krajick, 2006). Basically an inquiry-based learning environment should resemble that of professional scientists, focusing at the same time on contextualized, every-day situations (Bybee, 2006) in order to promote students' engagement and motivation. Moreover, inquiry-based learning environments may also help students develop "an understanding of what science is, what science is not, what science can and cannot do, and how science contributes to culture" (NRC, p. 21). Hence, didactical objectives may be widened, shifting focus from the understanding of science 'facts' to the understanding of science as an interpretative body of knowledge, i.e., to understanding of (aspects of) Nature of Science (NOS) (Schwartz & Crawford, 2006).

Only recently (NGSS, 2013), however, the nature of SI has been acknowledged as a content itself. Through inquiry, students should not only be engaged in epistemic practices (Kelly, 2008), but also learn what are the basic aspects of SI or, in other words, know what are the essential aspects that should be featured in an investigation in order to consider it a "scientific" one. Therefore, only few studies investigated students' knowledge about SI as a content (e.g., Lederman et al., 2014). The authors of these studies suggest that just as for NOS aspects, a meaningful understanding of what SI is should be obtained by an explicit teaching and not only by engaging students in activities, in which, often, inquiry features are tacitly adopted and exploited. Similarly, still no studies have thoroughly investigated the effects of an explicit teaching on students' knowledge of the Nature of SI, so that the influence of "declared" inquiry-based teachers' practice on students' knowledge of SI remains largely unknown. To address these issues, we selected and adapted seven inquiry-based teaching learning sequences (TLSs) in which the students not only are engaged in meaningful epistemic practices but are also explicitly taught about the main SI aspects through which scientific knowledge is developed (Schwartz, Lederman, & Crawford, 2004). We then observed the teachers that

implemented the TLSs and investigated whether the actual practice of teachers affected students' achievements in a pre-post test. Hence, this study was guided by the following research questions:

- Which is the students' knowledge of SI before and after participated to an inquiry-based TLS? (*RQ1*)
- Which aspects of the Nature of SI can be best promoted through an explicit teaching of SI? (*RQ2*)
- To what extent does students' knowledge about SI depend on teachers' practice? (*RQ3*)

2. Methods

Instrument

To answer our research questions, we used a modified version of the Views On Scientific Inquiry (VOSI) questionnaire (Lederman et al., 2014). We first compared the SI aspects targeted in the original questionnaire with the Italian secondary school science practice. The comparison was carried out with the help of the teachers that would have been involved in the submission of the questionnaire and the in-classroom delivery of the inquiry-based TLSs (see below). As a result, we selected the following aspects, listed below in alphabetic order:

- All scientists performing the same procedures may not get the same results
- Explanations are developed from a combination of collected data and what is already known
- Research conclusions must be consistent with the data collected
- Scientific data are not the same as scientific evidence
- Scientific investigations all begin with a question but do not necessarily test a hypothesis
- There is no single set and sequence of steps followed in all scientific investigations.

The original questionnaire featured seven open questions. We slightly changed the order of the questions and carried out the following modifications aimed at aligning the questions with Italian secondary school curricula:

Question 1 was split (1c as a stand-alone question) and two more contexts, related to astronomy and physics were added.

Question 5 was left out.

Questions 6 was tripled introducing two more contexts, one related to chemistry (a time-temperature two-column table for an ice cube that melts on a wooden and a metal surface); the other related to physics (a time-velocity two-column table for a ball thrown in the air).

Question 7 was split (7c as a stand-alone question) and a new question about mathematical modelling of a spreading fire in a forest was added.

Overall, the adapted VOSI instruments featured eleven questions. To validate the new questions, we pre-tested the whole questionnaire with a sample of about 20 students of the second year of a secondary school and then discussed the results with the teachers involved in the research study.

Description of the adopted TLSs

Since an important aim of the study was to investigate the effectiveness of explicit teaching of SI on students' achievements as measured by the VOSI instrument, particular care was devoted to the selection of the TLSs that should have been implemented in classroom practice. We first selected eleven existing research-based modules (SHU, 2009) and already validated in different educational contexts. Then, we modified them with the teachers that would have delivered the TLSs in classroom to include activities in which the SI aspects of the VOSI questionnaire could be explicitly taught. At the end of the process, seven TLSs were finalized. All the TLSs exploit realistic research contexts and engage students in the production of a meaningful research question related to the context and to the design of investigations to answer the question. In designing their investigations, the students work in small group, collect and analyze data and communicate their results to their peers. Emphasis is put on justification of conclusions on the basis of the collected data and evidences. According to the context, the students are asked either to produce written research-like papers, or to prepare videos and slide shows to present their results. A brief description of the TLSs with the prevalent SI targeted aspects is reported in Table 1. Despite modifications carried out, the TLSs could not focus in the same way on all the six SI aspects, so differences in students' achievements due to specific TLS they were engaged into might be expected.

Sample

The selected TLSs were delivered in 10 classrooms of five Italian secondary public schools including scientific lyceums and vocational schools. Overall, about 300 students of the first two years (14-16 ys) were

included. All students took on a regular basis physics and sciences courses, for at least four hours weekly. Seven biology, chemistry and physics teachers delivered the TLSs (one for each teacher). They ranged in experience between 20 and 30 years and were introduced to *Inquiry Based Science Education* (IBSE) throughout a training course of about 30 hours in which aspects of NOS and SI targeted in the VOSI were explicitly taught. Particular attention was put on the main features of the TLSs when the teachers themselves carried out the activities. They also discussed the draft version of VOSI questionnaire during the course and their comments were used to generate the final version of the instrument. Hence, the involved teachers were safely supposed to hold informed view about SI when they implemented the TLSs. Classroom activities lasted on average about 6 hours for each TLS.

Table 1: Description of TLS used in the study

Title	Context	What students do	Main SI aspects
Collision Course	Students, as scientists of the “Stellar Center”, have to produce a written report for NASA about possible risks for Earth due to collisions with asteroid	Investigations about the momentum and energy of objects in hits	A5-A1-A2
ET Phone Earth	Students, as TV journalists, have to prepare a television broadcast in which the possibility of extraterrestrial life will be discussed	Argument about evidence in favour and against the existence of extraterrestrial life	A6- A1
Green Heating	Students, as researchers of an advertising company, have to produce a document about advantages of solar thermal collectors for domestic use	Investigations about the role of materials in energy transfers between radiation and matter	A3-A4-A5
Green Light	Students, as consultants of Energy Efficient Lighting Committee, have to produce a document on main advantages of using compact fluorescent lamps	Investigations about the energy dissipation of a compact fluorescent lamp and an ordinary filament lamp	A3-A4-A5
Mars-ology	Students, as researchers at the Institute of Planetary Research, are asked by the NASA to propose a research study to be carried out with a space probe on Mars	Investigations about the role of lava viscosity on the shape of a volcano	A2-A3-A6
Out of site, out of mind	Students, as members of a city committee, have to study the risks of pollution due to landfills	Investigations about diffusion of polluting agents in the soil	A1-A6
Plants in Space	Students, as researchers of a department of bio-astronomy, have to develop suitable plans for a life sustaining unit for use on possible future space flights	Investigations about the dependence of photosynthesis on radiation wavelength	A4-A2

Classroom practice observations

When the seven TLSs were delivered in classroom practice, two external observes took field notes and video recorded the lessons. Overall, about twenty hours of video were collected, three hours for each TLS. Observations were guided by an adapted version of the Reformed Teaching Observation Protocol, (RTOP, Sawada et al., 2002), already validated by previous researches (e.g., Nam, Seung, & Go, 2013). Due to the specific focus of our study, we adapted some of the RTOP items so that they could describe the extent to

which the teachers implemented the specific inquiry aspects featured in the TLS and in the VOSI instrument. Overall, the used protocol featured 19 items, on a scale from 1 (item not descriptive) to 6 (item very descriptive). Eleven items strictly concerned SI aspects targeted by the VOSI questionnaire, while eight items concerned more general classroom management aspects.

Data analysis

In order to analyse students' answers, we first defined five categories, labelled from 1 to 5. For each question, we assessed as *Informed* (1) those answers that were correct and wholly congruent with the target response for a given aspect of SI. Answers which were incomplete yet on the whole coherent with the adopted view of a given aspect of SI were labelled as *Mixed or Partially correct* (2). Responses that were in contradiction with the adopted view of a particular aspect, or that corresponded to a known misconception about SI, were scored as *Naïve* (3). When it was not possible to understand a student's response or if the answer was only a "yes"/"no" statement without any justification, the answer was categorized as *Unclear* (4). Lastly, we assessed as *Not given* (5) all the questions left blank by students.

Reliability of categorisation was assessed as follows. Two authors first analysed all the answers separately; then, for each question, Cohen's Kappa was calculated (Table 2, second column). As the initial values of Cohen's kappa were not satisfactory (for instance, for Q7 and Q9 it was not possible to calculate it), the two raters discussed discrepancies in the categorisation and ratings were repeated to improve agreement. We then calculated again Cohen's Kappa values (see Table 2, third column). Values higher than 0.75 for all questions were obtained and hence a final categorization of students' responses was agreed.

Table 2: Values of the Cohen's kappa for reliability of the VOSI questionnaire

Question/SI Aspect	Initial Cohen's kappa	Final Cohen's kappa after discussion on specific cases
Q1 / A6	0,74	0,97
Q2 / A5	0,61	0,88
Q3 / A1	0,46	0,96
Q4 / A4	0,78	0,98
Q5 / A2	0,70	0,77
Q6 / A5	0,75	0,76
Q7 / A2	-	0,76
Q8 / A2	0,28	0,82
Q9 / A3	-	0,78
Q10 / A3	0,91	0,91
Q11 / A3	0,47	0,94

After having obtained a first categorization of student's answers, we re-coded the initial five categories into three macro-categories, labelled as C1, C2 and C3 (Table 3).

We then calculated, for each question, the percentage of students' responses in the three macro-categories and then averaged these percentages for the six SI targeted aspects. To evaluate whether students improved their views of SI after being involved in the proposed TLS, we compared, for each student, the results of the questionnaire submitted before and after the implementations. To this aim we defined, for each student, a "gain", i.e., the difference between the pre- and post-implementation scores according to the macro-categorization of Table 2 for all the VOSI questions. Students' gains could range from -2 to +2: a gain of 0 meant a positive or a negative improvement, +1 and +2 a positive improvement while -1 and -2 a negative improvement.

Table 3. Students' responses recoding after first categorization

First categorization	Typical answers for Q2 "Do you think that scientific investigation has necessarily start with a research question?"	Macro-categorization/Explanation
----------------------	---	----------------------------------

Informed	“Yes, because only if you have clear in mind the research question you can design a coherent scientific investigation in order to answer the question.”	C1/ Responses in this category reflect knowledge that is totally or partially consistent with the adopted view of the specific SI targeted aspect
Mixed	“Yes, otherwise we could not begin an experiment”	
Naïve	“No, because a scientific investigation could start also because the researcher is curious about something”	C2/Responses in this category are not congruent with the adopted views of the specific SI targeted aspect
Unclear	“Yes because without a question there could not be an answer”	C3/ Responses in this category are incomprehensible, unintelligible, or in no relation to the specific SI targeted aspect
Not given		

Finally, we looked for a possible relationship between students' gains and the way teachers implemented the TLSs. Two authors independently analysed video recordings of the classroom deliveries through the RTOP instrument. Out of the 19 adopted items, we calculated the average score only for the eleven items that concerned the targeted SI aspects. Then, since we wanted to investigate possible correlations between the overall enactment of the TLS on behalf of the teachers and the students' achievements, the mean values of the eleven SI items were again averaged so to obtain a *global* score for each teacher. On the basis of this score, we then categorized as *resonant* those teachers who obtained an average RTOP “high score” (greater than or equal to 4 on a scale of 6) and as *not resonant*, teachers who obtained an average RTOP “low score” (lower than 4). The cut-off threshold of 4 was chosen since it indicates that, on average, the RTOP items were clearly descriptive of what was going on in the classrooms. *Resonant* teachers were hence more likely keen to explicitly adopt and actually implement in their practice the specific aspects of SI present in the TLS. On the contrary, *Not Resonant* teachers modified the TLS so that specific aspects of inquiry were ignored or taught only implicitly. A chi-square analysis was finally carried out to investigate whether the hypothesized relationship between students' achievements and teachers' way of implementing the TLS was statistically significant.

3. Results

The pre-instruction VOSI questionnaire was completed by 227 students while the post-instruction questionnaire was completed by 156 students. Overall, 138 students completed pre-post questionnaires. In Table 4 we report the distribution (in percent) of the students' responses for the six SI aspects targeted in the questionnaire in the three macro/categories for the pre and post-test. Summative students' gains are also reported.

Table 4 Percentages of students' answers in the three macro-categories of analysis for each SI aspect

SI aspects	C1 (informed/mixed)		C2 (naïve)		C3 (unclear/not given)		Gains (%)	
	Pre	Post	Pre	Post	Pre	Post	No or negative	Positive
A1	9,4	9,4	61,6	57,2	29	33,3	77,5	22,5
A2	48,1	59,2	39,4	36,7	12,6	4,1	69,5	30,5
A3	19,3	20,0	56,5	65	24,2	15	73,9	26,1
A4	7,2	23,9	42,9	49,3	50,7	26,8	58,7	41,3

A5	12,7	10,9	53,3	58,4	34,1	30,8	76,1	24,0
A6	2,9	5,8	63,8	73,9	33,3	20,3	71,7	28,2

Data show that the percentage of informed responses slightly increased between pre- and post-test in the majority of the targeted aspects. Examples of naïve conceptions emerged in both pre- and post-test are: - science can be either deductive or inductive; - data are the results of an experiment, whereas evidence is a clear result; - scientists draw conclusions mostly on experimental certainties; - any mathematical expression is a result of a scientific investigation; - any hands-on activity could be an experiment; - performing the same procedure must lead scientists to the same conclusions.

Average percentage of informed or partially informed responses increased only from 16% to 21%. Accordingly, while about 30% of the students responses shifted towards an upper category in the post-test, this was due mainly to a decrease in the percentage of students' unclear responses or not given answers (from 31% to 21%).

To seek for an explanation of the limited impact of the TLSs, we looked at the relationships with teachers' practice. According to the average RTOP global scores, only four teachers (total of about 82 students) were on the whole *resonant* while three (total of 56 students) were globally not resonant. Table 5 shows for each SI targeted aspect the percentage of students whose view of SI improved between pre- and post-test for resonant and not resonant teachers. Results show that the majority of students who showed a positive gain between pre- and post-test were involved in TLSs implemented by resonant teachers. For three aspects (A1, A4 e A6), the differences are statistically significant.

Table 5: Distribution of summative students positive gains in % for *resonant* and *not resonant* teachers.

SI Aspects	Resonant teachers	Not Resonant teachers
A1*	74,2	25,8
A2	69,8	30,2
A3	65,8	34,2
A4*	73,7	25,3
A5	67,2	32,8
A6*	82,1	17,9

* indicates aspects for which the different distribution of students' responses is statistically significant

4. Discussion and conclusions

Concerning RQ1, we can observe that students' views about SI at the beginning of secondary school stream are generally not informed. Actually, for five out of six aspects, the percentage of C1 responses is lower than 20%. Only for one aspect (A2), the pre-test percentage of responses coded as C1 is about 50%. Such a positive result may be related to the fact that students may have been taught about how to make scientific inferences from experimental data and justify conclusions already at the middle-school level. As an alternative explanation, the related questions (Q7 and Q8, Table 2) used contexts (spreading of fire in a forest and assembling of a dinosaur skeleton) which likely resulted more familiar to students. The lowest percentage of C1 responses in the pre-test, 2.9, was obtained for the SI aspect A6. This results could have been due to the usual presentations of physics textbooks, which often underline the existence of only one scientific method, the one described by Galileo Galilei. On the other hand, biology and chemistry science textbooks usually focus on the existence of *two* scientific methods, one based on induction, the other based on deduction. In both cases, textbooks underline that there is a fixed sequences of steps to follow during a scientific research. Despite during the TLS delivery the teachers did not use textbooks, students could have used textbooks before the classroom activities thus influencing questionnaire's results.

Concerning RQ2, we found a statistically significant improvement, from 7.2% to 23.9%, for the SI aspect that concerned the difference between scientific evidence and data (A4). This result was somehow expected, since most of the TLSs' activities helped students discuss about the results and conclusions obtained by the different working groups. In this way, students could understand the difference between having a single experiment data collection and having results coming from more and/or different experiments. Moreover,

such evidence suggests also that most teachers put emphasis on data collection and the meaning of scientific evidence. On the contrary, quite unexpected was the low C1 frequency for the A3 aspect, about 20%, in both pre- and post-test. Actually, at the beginning of the secondary school, students are supposed to have the competence of reading tables and graphs. For this reason, teachers may have overlooked students' difficulties with this SI aspect during the implementation of the TLS. Similarly, the frequency of C1 responses for the A1 aspect was quite low (about 10%) in both pre- and post-test. This result may likely be due to the lack of time devoted to discussing with students alternative investigation procedures and explanations of collected evidences. Finally, for the A5 aspect we observed a slight decrease between pre and post-test. When looking in more detail the two questions related to this aspect (Q2 and Q6, Table 2), we noticed that the students performed much better in Q6 than Q2. The latter asked explicitly if a scientific investigation should start with a research question: while the TLS focused on the generation on behalf of students of a research question to begin the investigation, most students in the post-test claimed that a scientific investigation starts also from a real problem. This answer may be related to an over-emphasis on the realistic contexts of the TLSs.

Overall, our results suggest that only one TLS implementation in a very limited period of time may be not sufficient to have a significant positive impact on students' views about SI. It must also be taken into account that not all the TLSs targeted the SI aspects in the same way (Table 1), so further investigations are needed to understand if only some aspects can be promoted throughout an explicit teaching of SI. We plan to modify some of the TLSs to make them more suitable to target all the above SI aspects, and to implement them with a new sample of teachers and students.

Concerning RQ3, we found that the majority of positive gains have been related to implementations carried out by the four "resonant" teachers, who did adopted most of the SI inquiry aspects in their practice as measured by the RTOP. This result is in agreement with recent studies (Bartos & Lederman, 2014) and supports the claim that students' views about SI depends on the quality of the engagement into inquiry activities and on the teachers' way of teaching SI as a content.

However, the fact that three teachers were not resonant with the targeted SI principles was a quite unexpected result given the 30 hours training course that all the teachers followed. Although attention was put on addressing teachers' own naïve ideas about SI as emerged during the discussion of the draft version of the VOSI questionnaire, the course failed to provide teachers with a solid knowledge base about SI in order to effectively implement the TLS. In particular, the teachers lacked coherence between what they declared when discussing the questionnaire and what they did when delivering the TLSs in their practice. Hence, more research is needed to investigate the factors underlying teachers' adoption or transformation of inquiry-based teaching approaches. To this aim, we plan to investigate which are SI aspects that teachers mostly adopt or transform after training periods devoted to the explicit teaching of SI as content.

Acknowledgement

The research carried out in this paper was supported by the EC project: Chain Reaction - A Sustainable Approach to Inquiry Based Science Education, FP7-SCIENCE-IN-SOCIETY-2012-1, contract n° 321278

References

- Bartos, S. A. & Lederman, N. G., (2014) Teachers' knowledge structures for nature of science and scientific inquiry: Conceptions and classroom practice, *Journal of Research in Science Teaching*, 51, 1150–1184.
- Bybee, R.W (2006) Scientific Inquiry and Science Teaching. In L. B. Flick & N. G. Lederman (Eds.), *Scientific inquiry and nature of science. Implications for teaching, learning, and teacher education* (1-14). Dordrecht: Springer.
- Kelly, G. J. (2008) Inquiry, Activity and Epistemic Practice. In R.A. Duschl & R.E. Grandy (eds) *Teaching Scientific Inquiry. Recommendations for Research and Implementation* (99-117). Rotterdam: Sense
- Lederman, J. S., Lederman, N. G., Bartos, S. A., Bartels, S. L., Meyer, A. A. and Schwartz, R. S. (2014). Meaningful Assessment of Learners' Understandings About Scientific Inquiry — The Views About Scientific Inquiry (VASI) Questionnaire, *Journal of Research in Science Teaching*, 51, 65-83.
- Nam, J., Seung, E. & Go, M. (2013) The Effect of a Collaborative Mentoring Program on Beginning Science Teachers' Inquiry-based Teaching Practice. *International Journal of Science Education*, 35, 5, 815-836.
- National Research Council (NRC, 1996) *National Science Education Standards*. National Academy Press: Washington DC.

Next generation science standards (NGSS, 2013). On-line, retrieved June 25, 2013 from <http://www.nextgenscience.org/next-generation-science-standards>

Novak & Krajick, (2006). Using Technology To Support Inquiry In Middle School Science. In L. B. Flick & N. G. Lederman (Eds.), *Scientific inquiry and nature of science. Implications for teaching, learning, and teacher education* (75-101). Dordrecht: Springer.

Sawada D., Piburn, M.D., Judson E., Turley J., Falconer K., Benford R. & Bloom I. (2002). Measuring reform practices in science and mathematics class-rooms: The Reformed Teaching Observation Protocol. *School Science and Mathematics*, 102, 245–253

Schwartz, R. S., & Crawford, B. A. (2006). Authentic scientific inquiry as context for teaching nature of science. In L. B. Flick & N. G. Lederman (Eds.), *Scientific inquiry and nature of science. Implications for teaching, learning, and teacher education* (331–355). Dordrecht: Springer.

Schwartz, R.S., Lederman, N.G. & Crawford, B. (2004). Developing views of nature of science in an authentic context: An explicit approach to bridging the gap between nature of science and scientific inquiry, *Science Education* 88, 610-645.

Sheffield Hallam University (SHU, 2009) *Earth and Universe Project Research Briefs*. On-Line, retrieved 11-08-2014, www.chreact.eu

Affiliation and address information

Silvia Galano
Department of Physics - University “Federico II”, Naples
Complesso M.S. Angelo, Via Cintia
80126 Napoli, Italy
e-mail: galano@fisica.unina.it

Development of Teaching Materials: a Course for Geometrical Optics for Lower Secondary Students

Claudia Haagen¹, Martin Hopf²

¹ University of Graz, Didactics of Physics

² University of Vienna, Plattform für Didaktik der Naturwissenschaften (AECCs)

Abstract

Geometrical optics is one of the core topics in physics instruction in lower secondary. Numerous learning difficulties and students' conceptions have been identified by Physics Education Research (PER) during the last decades. This knowledge about domain specific learning problems has rarely been used for the rearrangement of instruction. PER shows that conventional instruction is in many cases not able to help students understand basic scientific concepts. In a few research projects learning environments and content structures were empirically evaluated which proved to be significantly more successful than conventional instruction. Our aim was to design and evaluate student material for a research based optics course following the paradigm of Design Based Research.

Keywords

Conceptual change, geometrical optics, teaching material

1. Background & Aims

Subject specific learning, students' conceptions and learning difficulties have been core fields of PER of the last decades. The insights gained about domain specific learning has however rarely been used for effective rearrangements of instructional designs or instructional materials. "Basic research in education is viewed as irrelevant by practitioners" (Duit, Gropengießer, Kattmann, Komorek, & Parchmann, 2012, p.15) and thus rarely effects school teaching practice. On the other hand, our experience shows that teachers are longing for teaching materials ready to use in class. So the idea behind our optics project is to find an informal channel of implementing research results on domain specific learning into school practice by offering teachers research based teaching materials and short in-service training workshops.

2. Theoretical Framework

The theoretical framework of the research project presented is based on a constructivist approach towards learning. In order to reflect this theoretical framework in the context of our research project the topic of conceptual change and students' (pre/mis)conceptions are discussed. Conceptual change has become one of the most popular theoretical frameworks when studying learning and instruction in the field of science subjects since the 1980s. Students enter instruction with pre-knowledge which is mostly not congruent with physical concepts. Their everyday ideas are yet quite stable and cannot easily be "exchanged" by adequate concepts as learning is an individual process of active knowledge construction guided by pre-knowledge.

In order to promote conceptual change it is necessary to be familiar with the initial conceptual status of students. The topic of optics has been researched thoroughly. The scope of this paper is however too limited to discuss students' conceptions in optics in detail, a collection of research can be found in Duit (2009). For this paper the alternative ideas on vision and visibility of objects are chosen to exemplify the procedure of material development. One fundamental alternative idea, resulting in learning difficulties in many subdomains of geometrical optics is the concept of vision. If students do not grasp the idea of vision thoroughly, they have little chance of succeeding in gaining conceptual insight into other sub domains of optics (Andersson & Kärqvist, 1983). The main categories of student alternative conceptions related to vision were categorized by Guesne (1985, p.28) and confirmed by many other researchers (Hosson & Kaminski, 2007; Wiesner, 2007a). For students it seems to be very difficult to establish an adequate relationship between the light source, the object illuminated and the observer. Another odd idea from a learner's point of view is that bodies absorb and selectively re-emit light.

3. Design, Development of Materials and Research Methods

A design of successful learning environments needs to merge the subject matter point of view on a certain topic with related student perspectives (including preconceptions and interests). Practitioners frequently do not balance both sides for several reasons. The aim of this project on introductory optics was to develop research based materials which are ready to be used in authentic school settings and which promote a deeper conceptual understanding than conventional instruction. At the same time, our project aims at generating deeper insight into students' domain specific reasoning in geometrical optics. This double task could best be realised within the framework of Design Based Research (DBR). This research programme is introduced in the following section. In addition, preliminary works are presented, before the development and the evaluation of the teaching materials are reported. Since the scope of this paper is limited, only a broad overview of the design process can be given. Two parts related to the development of the chapter on Vision and Visibility of Objects can be treated in more detail: Firstly, the implementation of a sender-receiver model of vision for understanding the visibility of objects. Secondly, the implications of the sender-receiver model for the content structure of the chapter on Colour.

4. Preliminary Developments

In the past, a number of empirically tested interventions on subtopics of geometrical optics (Schön et al., 2003; Viennot & Hosson, 2012; Wiesner, Engelhardt, & Herdt, 1995; Sokoloff, 2006) proved to promote conceptual learning processes. We focused on the work of Wiesner et al. (Wiesner et al., 1995; Wiesner, Engelhardt, & Herdt, 1996; Wiesner, Herdt & Engelhardt, 2003; Schmidt-Roedenbeck, Müller, Wiesner, Herdt, & Engelhardt, 2005).

The content structure of the course by Wiesner et al. was mainly based on ideas by Jung (Jung, 1982; Jung, 1981) and Wiesner (Wiesner, 1995; Wiesner, 2007b; Wiesner & Claus, 2007) who both had investigated students' conceptual knowledge-bases and learning processes in numerous settings with different methods. There are a number of features which distinguish this course from conventional instruction: A sender-receiver model of vision, which is the basis for all optical phenomena, is introduced early and used throughout the course. In addition, propagating light is represented by beams having the shape of light cones to keep track with phenomena instead of transforming them right from the beginning into the abstract model of rays. Consequently, ray diagrams are introduced in the course at a late stage. When ray diagrams are used, they are always linked to the phenomenon and its characteristic path of light, starting from a light source, interacting with matter until finally arriving at an observer (Wiesner, 2007a). Herdt collected the instructional ideas of Jung and Wiesner and synthesised them to a full course published as teachers' book in 5 volumes. Herdt (Herdt, 1990) also evaluated this course and showed students' significantly better mastery of concepts compared to conventionally instructed students.

Our optics project is mainly based on the course by Wiesner and Herdt. In addition, more recent empirical findings about domain specific learning in optics (Colin, Chauvet, & Viennot, 2002; Martinez-Borreguero, Pérez-Rodríguez, Suero-López & Pardo-Fernández, 2013; Haagen-Schützenhöfer & Hopf, 2014; Scheid, 2013; Viennot & Hosson, 2012) were additionally taken into account. In contrast to the materials published by Wiesner et al., which focused on teachers as target group, our aim was to develop student material.

5. Design Based Research & Design Process of Student Material

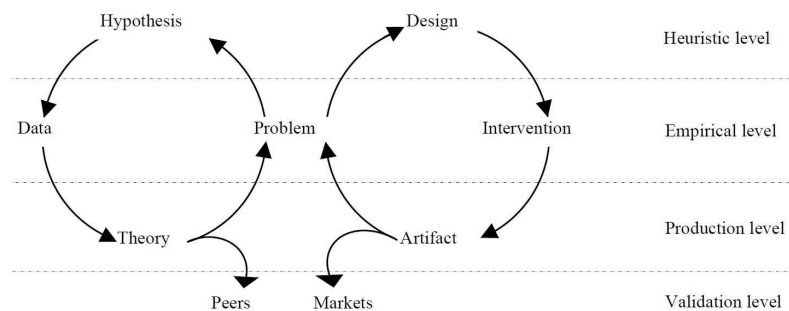

Figure 1: Model des Design-Based-Research based on Ejersbo et al. (2008, p.5)

Design Based Research is an approach “which blends empirical educational research with the theory-driven design of learning environments. [An overall aim of DBR is to learn] how, when, and why educational

innovations work in practice” (The Design-Based Research Collective, 2003), p.5). DBR intertwines two processes: A classical research cycle (Fig.1, left) which reflects a prototypical procedure of science educational research, generating theories and a product cycle (Fig.1, right) which produces artefacts (teaching materials, learning strategies, curricula, etc.) for school practice.

The following section outlines how the model of DBR was applied in the optics project (Haagen-Schützenhöfer, 2015). As already mentioned, both design cycles are generally triggered by a problem. In our case the initial problem for both cycles was the unsatisfying performance of students after their formal instruction in geometrical optics (Haagen-Schützenhöfer & Hopf, 2012). Learning difficulties known from literature and found in our investigations plus effective instructional strategies extracted from different research studies served as basis for the design of student material (cf. Fig. 2).

As a first step the teacher’s books by Wiesner et al. were roughly “translated” into a student text in course book style. In doing so, each chapter was educationally reconstructed (Kattmann & Duit, 1998). To sketch the process of educational reconstruction in our project the example of vision is again taken up. In the first reconstruction process, the topic “Vision and Visibility of Objects” was reflected from the perspectives of all three components of the model: In a first step elementary key concepts of optics were isolated based on a clarification of the science content matter and on an analysis of its educational significance. These key ideas were arranged according the content structure (internal structure and relation of key-ideas) used by Wiesner et al.. In a second step, students’ conceptions and learning problems known from PER were analysed and the intended educational aims were aligned. Based on this analysis, in a third step, teaching experiments were carried out to follow the conceptual learning process triggered by the materials (cf. Fig. 2, “Intervention”). Results of the teaching experiments with the year 8 pre optic students were used to redesign this chapter (cf. Fig. 2, “Design”) and its slightly changed version was again evaluated with teaching experiments. After some iterations going back and forth between the heuristic and the empirical level (Fig. 2), a saturation effect was reached in the teaching experiments. As a result, a preliminary version of the materials was produced which differed from the original version mainly on the micro level (conceptualization of some key-ideas) and on the meso level (arrangement of key ideas within a chapter of the course).

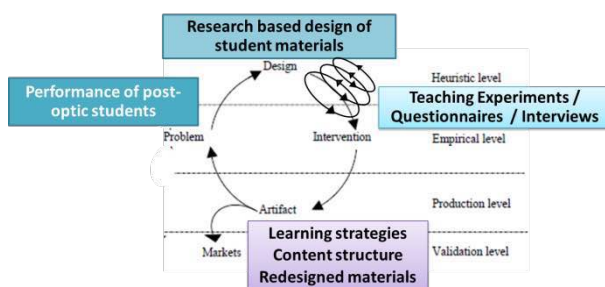

Figure 2: Product cycle within DBR (adopted from Ejersbo et al., 2008, p.5)

This preliminary student text was tested in school settings in one year 8 class. Problems identified in these field phase were the starting point for entering in another DBR cycle.

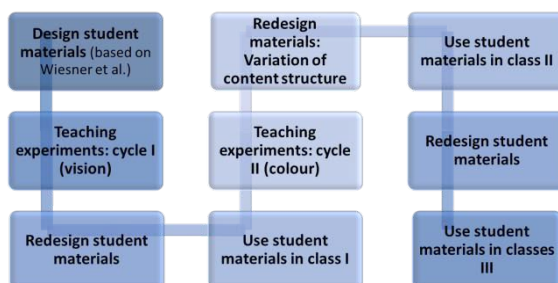

Figure 3: Development process on the macro level

The following design cycles can not be treated in this paper. The macro structure of the research process with its different phases of teaching experiments and classroom iterations is summarized in Figure 3. The focus of this paper will be put on “Teaching experiments: cycle I (vision)” and on “Teaching experiments: cycle II (colour)”.

In parallel to designing the student text (product cycle), hypotheses on learning in subdomains of geometrical optics were investigated in the research cycle (cf. Fig. 1, left). Data generated in the teaching experiments allowed the reconstruction of students' learning processes and progressions. Finally local theories on the learning of certain subdomains of geometrical optics could be generated.

6. Teaching Experiments

To meet the needs of both cycles of the DBR framework we were looking for an adequate method to evaluate our aims. The method of teaching experiments as used by (Jung, 1992; Komorek & Duit, 2004; Wiesner & Wodzinski, 1996) served our purposes best. The aim of teaching experiments is to investigate students' learning processes in settings which are similar to instruction in school. As a result, teaching experiments are supposed to reveal instructional elements promoting meaningful learning as well as learning obstacles caused by instructional designs. In short, teaching experiments are a method for evaluating the effectiveness of learning environments and at the same time they provide data for research on students' conceptual knowledge bases and local theories on learning.

7. Research Design: Data Collection, Methods of Data Analysis and Results

The description of our project on introductory optics shows that data was collected on several levels with different methods. The length of this paper is limited, as a consequence only a snapshot of data, analysis and gained results can be reported. The series of teaching experiments carried out for designing the first chapter on Vision and Visibility of Objects and for the chapter on Colour provide the data basis for this section of the paper.

The paradigm of DBR is an adaptive one in the way that results achieved by data collected and analysis, instantaneously have an impact on the design process. Consequently, when giving an overview of the project, it does not make sense to separate data collection and analysis from results and put them into different chapters.

8. Vision and Visibility of Objects

The first chapter of the course was on Vision and Visibility of direct and indirect sources of light. A first impression on students' reactions to the text was gathered by questionnaires. A year 8 pre optics class was given three pages of the very first version of the text, and answered open questions. After this first check and minor changes, teaching experiments were carried out, this time using not only three pages of student text but the full first chapter. In each teaching experiment, which lasted on average 115 minutes, two students (N=8) took part. The data collected were video-tapes of the teaching experiment, and the written artefacts the students produced when working on the tasks in the material (Haagen-Schützenhöfer, Rottensteiner & Hopf, 2013).

The video data collected in the teaching experiments was transcribed and analysed following the procedure of qualitative content analysis as described by Mayring (2010). The category formation for our data was based on the categories used by Guesne (1985) and Blumör (1993). The material was double coded and the intercoder reliability was calculated following Holsti's coefficient $r_H=0.79$ (1969).

Figure 4 shows the analysis of the different phases of the teaching experiments: The rows represent students' reactions to key ideas introduced with help of the student material. For each key idea, the teaching experiment triggers three different types of student behaviour:

1. Acceptability: how acceptable do students perceive the way the key idea is transmitted by the material
2. Reproduction: how do the students summarize the key idea in their own words
3. Transfer: which concepts do students use when solving a transfer task based on the initial key idea.

Each row of Figure 4 represents one of these types of student behaviour for the key ideas of the first chapter of the material.

Each column portrays the learning path of an individual student. While the comparison of the test items and the output in the transfer phases (indicated in Fig. 4) show a conceptual development towards the physicists' model of vision in general, line four indicates that the majority of students rejected the instructional element related to the pinhole camera.

At this stage of the course, the pinhole camera was introduced as detector of light reception. Here, the course follows the line of argumentation that we can only see objects when they send off light into our eyes. The pinhole camera is introduced as a simple model for our eyes. As already mentioned, one basic principle of

the chapter on colour had started with the idea “white light can be split up into the spectral colours”, going on with the mechanisms on selective absorption and reemission when light and matter interact. The new content structure started with the key idea that two light colours can be mixed and result in a new one (cf. Fig. 5). After deepening this key-idea, the reciprocal mechanism, showing that light can be split up into its spectral colours, was introduced. This changed concept was tested with N=8 year 9 students in further teaching experiments.

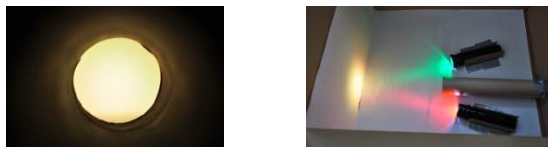

Figure 5: What is inside the box that produces a yellowish spot? Green & red light mingles to yellow.

The teaching experiments were again videotaped and the tasks in the student text produced written data. The data was analysed with qualitative content analysis and categories were based on the results achieved by Blumör (1993). The intercoder reliability of the two coders reached $r_H=0.82$.

10. Conclusion

Results achieved in the optics project can be reported on different levels: on the level of the development of student material and on the level of research on students' domain specific conceptions. On the level of material design, it turned out that the content structure of the optics course by Wiesner et al. worked fine in most of the cases for our students. The only big changes, which we had to make, were to shift the chapter on body colours and position it after the introductory chapter on Vision and Visibility of Objects. Secondly, the type of pinhole camera used as detector for light reception turned out to draw students' attention too much into technical details of the pinhole camera. Consequently we had to substitute it. The sender-receiver model of vision as well as the strategy to follow the path of light from the light source up to the observer are continuously used in the course. This turns out to be successful and supports the students in understanding the visibility of objects and their body colour on a deeper conceptual level.

On the level of students' domain specific learning we could reproduce students' conceptions already known from research. On the other hand, we found problematic alternative conceptions in our cohort, which have not been discussed in literature thoroughly. One example that can be mentioned in this context is the conception about the spectroscopic characteristics of sunlight and similar forms of light. Students tend to believe this sort of light is rather a mixture of yellowish light colours. Additionally, they do not often conceptualize light resembling sunlight as a mixture of the spectral colours, neither do they think the term “white light” denotes the light they perceive as sunlight or its graphical representations (Haagen-Schützenhöfer, 2014). In conclusion it can also be said that the chosen research programme of Design Based Research, especially in combination with the qualitative methodological approach of teaching experiments, proved to be fruitful for the research aims of this project. It helped to go beyond the surface level of “just” evaluating the intervention. On the contrary, deep insight into students' domain specific reasoning could be gained which may not only be of great value for this project, but also for teaching optics in general.

References

- Andersson, B., & Kärrqvist, C. (1983). How Swedish pupils, aged 12-15 years, understand light and its properties. *International Journal of Science Education*, 5(4), 387–402.
- Blumör, R. (1993). *Schülerverständnisse und Lernprozesse in der elementaren Optik: Ein Beitrag zur Didaktik des naturwissenschaftlichen Unterrichts in der Grundschule*. Magdeburg: Westarp Wissenschaften.
- Colin, P., Chauvet, F., & Viennot, L. (2002). Reading images in optics: students difficulties and teachers views. *International Journal of Science Education*, 24(3), 313–332.
- Duit, R. (2009). Bibliography — STCSE: Students' and teachers' conceptions and science education. Retrieved October 20, 2009.
- Duit, R., Gropengießer, H., Kattmann, U., Komorek, M., & Parchmann, I. (2012). The Model of Educational Reconstruction – a Framework for Improving Teaching and Learning Science1. In D. Jorde & J. Dillon (Eds.), *Science education research and practice in Europe* (pp. 13–37). Springer.
- Ejersbo, L. R., Engelhardt, R., Frølund, L., Hanghøj, T., Magnussen, R., & Misfeldt, M. (2008). Balancing product design and theoretical insights. In A. E. Kelly, R. A. Lesh, & J. Y. Baek (Eds.), *Handbook of design*

research methods in education: Innovations in science, technology, engineering, and mathematics learning and teaching (pp. 149–163). Routledge.

Gropengießer, H. (2005). Qualitative Inhaltsanalyse in der fachdidaktischen Lehr-Lernforschung. Die Praxis der Qualitativen Inhaltsanalyse, 172–189.

Guesne, E. (1985). Light. In R. Driver, E. Guesne, & A. Tiberghien (Eds.), *Children's ideas in science* (pp. 10–32). Buckingham: Open University Press.

Haagen-Schützenhöfer, C., & Hopf, M. (2012). Testing students' conceptual understanding in geometrical optics with a two tier instrument. In M. F. Taşar (Ed.), *World Conference on Physics Education 2012*.

Haagen-Schützenhöfer, C., Rottensteiner, J., & Fehringer, I. (2013). Unterrichtsmaterialien für den Anfangsoptikunterricht (Sekundarstufe I), AECCP, Universität Wien.

Haagen-Schützenhöfer, C., Rottensteiner, J., & Hopf, M. (2013). Akzeptanzbefragung zu Optikunterrichtsmaterialien. In S. Bernholt (Ed.), *GDCP Jahrestagung in Hannover 2012: Inquiry-based Learning – Forschendes Lernen* (pp. 431–433). Kiel: IPN.

Haagen-Schützenhöfer, C., Fehringer, I., & Hopf, M. (2014). Akzeptanzbefragung zu Optikunterrichtsmaterialien: Farben. In S. Bernholt (Ed.): *GDCP Jahrestagung in München 2013: Naturwissenschaftliche Bildung zwischen Science- und Fachunterricht* (pp. 639–641). Münster/New York: LIT Verlag.

Haagen-Schützenhöfer, C. (2014). Students' Conceptions on the Nature of White Light. In Dvorak Leos (Ed.), *Proceedings ICPE 2013*. Prague.

Haagen-Schützenhöfer, C. (2015). Physikdidaktische Entwicklungsforschung am Beispiel Geometrische Optik. In S. Bernholt (Ed.): *GDCP Jahrestagung in Bremen 2014: Heterogenität und Diversität*. Münster/New York: LIT Verlag.

Herdt, D. (1990). Einführung in die elementare Optik. Vergleichende Untersuchung eines neuen Lehrgangs. Essen: Westarp-Wissenschaftsverlag,

Holsti, O. (1969). *Content analysis for the social sciences and humanities*. Reading, Mass.: Addison-Wesley Pub. Co.

Hosson, C. de, & Kaminski, W. (2007). Historical Controversy as an Educational Tool: Evaluating elements of a teaching–learning sequence conducted with the text “Dialogue on the Ways that Vision Operates”. *International Journal of Science Education*, 29(5), 617–642.

Jung, W. (1981). Erhebungen zu Schülervorstellungen in der Optik (Sek. I). *physica didactica*, 137–153.

Jung, W. (1982). Fallstudien zur Optik. *physica didactica*, 9, 199–220.

Jung, W. (1992). Probing acceptance, a technique for investigating learning difficulties. In R. Duit, F. Goldberg, & H. Niedderer (Eds.), *Research in physics learning: Theoretical issues and empirical studies*. Kiel: Institut für die Pädagogik der Naturwissenschaften an der Universität Kiel.

Kattmann, U., & Duit, R. (1998). The model of educational reconstruction. Bringing together issues of scientific clarification and students' conceptions. In Bayrhuber (Ed.), *What-Why-How? Research in Didaktik of biology* (pp. 253–262).

Komorek, M., & Duit, R. (2004). The teaching experiment as a powerful method to develop and evaluate teaching and learning sequences in the domain of non-linear systems. *International Journal of Science Education*, 26(5), 619–633.

Martinez-Borreguero, G., Pérez-Rodríguez, Á., Suero-López, M., & Pardo-Fernández, P. (2013). Detection of Misconceptions about Colour and an Experimentally Tested Proposal to Combat them. *International Journal of Science Education*, 35(8), 1299–1324.

Mayring, P. (2010). *Qualitative Inhaltsanalyse: Grundlagen und Techniken*. Weinheim: Beltz.

Scheid, J. (2013). *Multiple Repräsentationen, Verständnis physikalischer Experimente und kognitive Aktivierung: Ein Beitrag zur Entwicklung der Aufgabenkultur*: Logos-Verlag.

Schmidt-Roedenbeck, C., Müller, R., Wiesner, H., Herdt, D., & Engelhardt, P. (2005). *Unterricht Physik, Optik III/2. Wölb- und Hohlspiegel, Spiegelteleskop, Auge, Farben (3/2)*. Köln: Aulis.

Schön, L., Erb, R., Weber, T., Werner, J., Grebe-Ellis, J., & Guderian, P. (2003). *Optik: Optik in Mittel- und Oberstufe*.

Sokoloff, D. (2006). *Active Learning in Optics and Photonics*. UNESCO. Paris, France,

- The Design-Based Research Collective. (2003). Design-based research: An emerging paradigm for educational inquiry. *Educational researcher*, 5–8.
- Viennot, L., & Hosson, C. de. (2012). Beyond a Dichotomic Approach, The Case of Colour Phenomena. *International Journal of Science Education*, 34(9), 1315–1336.
- Wiesner, H. (1995). Physikunterricht an Schülervorstellungen und Lernschwierigkeiten orientiert. *Unterrichtswissenschaft*, 23(2), 127–145.
- Wiesner, H., Engelhardt, P., & Herdt D. (1995). Unterricht Physik, Optik I: Lichtquellen, Reflexion. *Unterricht Physik: Vol. 1*. Köln: Aulis Verlag Deubner & Co.
- Wiesner, H., Engelhardt, P., & Herdt D. (1996). Unterricht Physik, Optik II: Brechung, Linsen. *Unterricht Physik: Vol. 2*. Köln: Aulis Verlag Deubner & Co.
- Wiesner, H., & Wodzinski, R. (1996). Akzeptanzbefragung als Methode zur Untersuchung von Lernschwierigkeiten und Lernverläufen. In R. Duit & C. von Rhöneck (Eds.), *Lernen in den Naturwissenschaften*. Kiel: IPN.
- Wiesner, H., Herdt, D., & Engelhardt, P. (2003). Unterricht Physik, Optik III/1. Optische Geräte (3/1). Köln: Aulis.
- Wiesner, H., & Claus, J. (2007). Vorstellungen zu Schatten und Licht bei Schülern der Primarstufe. In R. Müller, R. Wodzinski, & M. Hopf (Eds.), *Schülervorstellungen in der Physik*. Köln: Aulis.
- Wiesner, H. (2007a). Schülervorstellungen und Lernschwierigkeiten im Bereich der Optik. In R. Müller, R. Wodzinski, & M. Hopf (Eds.), *Schülervorstellungen in der Physik (2nd ed.)*. Köln: Aulis.
- Wiesner, H. (2007b). Schülervorstellungen und Lernschwierigkeiten mit dem Spiegelbild: In R. Müller, R. Wodzinski, & M. Hopf (Eds.), *Schülervorstellungen in der Physik (2nd ed.)*. Köln: Aulis.

Affiliation and address information

Ass.-Prof. Dr. Claudia Haagen-Schützenhöfer, Department of Physics, Didactics of Physics, University of Graz,
Universitätsplatz 5
8010 Graz, Austria
e-mail: claudia.haagen@uni-graz.at

Simple Experiments Supporting Conceptual Understanding of Body Colour

Claudia Haagen

University of Graz, Didactics of Physics

Abstract

Teaching colour phenomena in introductory optics courses at school is a challenge, as this subdomain turns out to be one of the most difficult topics within geometrical optics. A number of physical adequate key concepts, which are not promoted by everyday experience, are necessary to understand the phenomenon of body colour. This paper introduces some easy hands-on experiments as the core elements of an intervention based on principals of constructivist learning.

Keywords

Introductory optics, body colour, easy experiments

1. Introduction

We perceive our environment mainly through visual stimuli. Seeing colours is one eminent part of visual perception. Colour phenomena like rainbows or blue and red skies cause usually a wow-effect among observers. Despite these motivating effects of colour phenomena, understanding the underlying physical concepts poses a big challenge especially for students in introductory optic courses (Martinez-Borreguero, Pérez-Rodríguez, Suero-López, & Pardo-Fernández, 2013).

Over the past years, Physics Education Research has extracted a number of students' alternative conceptions, which hinder the understanding of colour phenomena. Nevertheless, the instructional basis of teaching colours in physics has hardly been influenced by these results and learning about colour phenomena is frequently still reduced to memorizing the laws of additive and subtractive colour mixing. At the best, these “colour laws” can then be correctly recited by students. This however does not lead to any conceptual understanding of the underlying processes (Viennot & Hosson, 2012). What students mostly retain and use in any situation - if appropriate or not – are the mixing rules they know from their water colour boxes. As a consequence students are hardly able to solve tasks on body colour.

What makes the situation of instruction even more difficult in Austria is that the physics curriculum of year 8 contains colour phenomena as part of geometrical optics. The wave nature of light is, however, not part of year 8, but is first brought up in year 10. Consequently, the teaching of colour phenomena is restricted to reconstructions of body colours not including the wave aspect of light. As a result teachers frequently reduce instruction to the “rules of colour mixing”.

In the course of a project on introductory optics (Haagen-Schützenhöfer, Rottensteiner, & Fehringer, 2013; Haagen-Schützenhöfer, Fehringer, & Hopf, 2014), a series of easy to carry out experiments were developed to trigger conceptual understanding body colour phenomena.

2. Students' conceptions

One prerequisite for understanding optics, including colour phenomena, on a basic level is the idea that objects which do not produce light themselves are able to absorb and reemit light. Only when light (re)emitted by an object enters the eye of an observer, he or she can perceive the object. This sender-receiver mechanism also determines the kind of colour we see, as the colour depends on the kind of light we receive. Consequently, without this basic concept of a sender - selective (re)emission - receiver model, it seems to be difficult to develop scientifically adequate ideas concerning colour and coloured objects.

However, there are a number of students' alternative ideas about vision (Hosson & Kaminski, 2007; Guesne, 1985). Besides not adequate ideas about the process of vision, students have incorporated a number of alternative ideas about how colour phenomena come into existence. This paper focuses on the topic of body colours. Feher and Meyer (Feher & Meyer, 1992) summarize the following ideas as the most frequent categories of students' conceptions on the colour of illuminated objects:

- coloured light mixes with the colour of the object,
- coloured light is dark and makes objects appear darker,
- coloured light gives its colour to the object,
- coloured light has no effect on the appearance of objects.

What makes it even more difficult for students to understand colour phenomena are their inadequate ideas on light in general and on white light in particular. The concept that two light colours can mix up to a new one or vice versa that light can be split up in its spectral components, is not obvious to learners. When it comes to white light, there is an even bigger number of obstacles hindering conceptual understanding. The most important for our topic are:

- White light and sunlight are not composed of different (spectral) colours.
- White light is “bright” and lets you see the colours of the object.
- Yellow is light like the sun, bright and warm (Feher & Meyer, 1992).

Conventional instruction is frequently not successful in improving this lack of adequate concepts about light, vision and colour (Andersson & Kärqvist, 1983; Haagen-Schützenhöfer & Wallner Benjamin, 2012; Martinez-Borreguero, Pérez-Rodríguez, Suero-López, & Pardo-Fernández, 2013). One reason seems to be that instructional designs used by teachers and also by textbooks (Haagen-Schützenhöfer & Holzmeier, 2013) do mostly not take students’ conceptual bases into account and mostly fail to provide learners with instructional elements which they can integrate in their everyday knowledge.

Constructivist theories of learning, which serve as basis for conceptual change strategies, clearly state that learners integrate instructional input similar to each other kind of incoming information into their already existing individual knowledge about the world. This individual knowledge about the world has been acquired in uncountable everyday experiences and has therefore become deeply rooted and reinforced over years. This individual knowledge is also an essential factor for the mechanism of information processing. “Students are frequently unable to understand the new theory, because their old conceptions provide the interpretation schemata, the goggles so to speak, for looking at the new science conceptions” (Duit & Treagust, 1998; p.15). Information made available by the environment is filtered and can easily be transformed or altered in a systematic way, depending on the already existing individual knowledge base (Guesne, 1985). Consequently, it does not seem to be very surprising, that instruction which does not take students’ conceptions and domain specific learning difficulties into account, does not result in conceptual change and understanding but at best in students who are able to recite key sentences for a short period after instruction.

3. Educational Reconstruction of Colour Phenomena for Introductory Optics

For the design of our learning environment focusing on body colour we used the frame of Content Representations (CoRes) as used by (Hume & Berry, 2011; Loughran, Mulhall, & Berry, 2004; Mulhall, Berry, & Loughran, 2003). Originally, CoRes were developed to represent science teachers’ PCK on a science topic. “A CoRe sets out the aspects of PCK that are most closely attached to a science topic, and that most probably extend across various contexts (e.g., the key content ideas, known alternative conceptions, insightful ways of testing for understanding, known points of confusion, and ways of framing ideas to support student learning)” (Loughran, Mulhall, & Berry, 2008, p.1305). CoRe construction turned out to be also supportive in pre-service courses (Hume & Berry, 2011).

We used the CoRe structure as a skeleton for designing our learning environment on colours, following the framework of the Austrian curriculum for year 8. “A CoRe (Content Representation) provides an overview of how teachers approach the teaching of the whole of a topic and the reasons for that approach - what content is taught and how and why - in the form of prompts. Importantly, a CoRe refers to the teaching of a particular topic to a particular group of students (e.g., mixed ability, Grade 10 general science class)” (Mulhall et al., 2003, p.6)

A CoRe contains a list of the “big idea/concepts” for teaching a topic. These “big ideas/concepts”, or key ideas/concept, as we called them in our project, are arranged in the first row of the CoRe matrix according to their appearance in the learning environment. Basically, this first row of key concepts outlines the content structure of the learning environment. So at the top of each column of the CoRe matrix, we find the key idea which is then reflected from different perspectives in the following lines of this column. For this process, a number of guiding prompts is put for each subsequent line:

1. What I intend the students to learn about the idea
2. Why is it important for the students to know this

3. What else do you know about this idea (that you do not intend the students to know yet)
4. Difficulties/limitations connected with teaching this idea
5. Knowledge about students thinking which influence your teaching of this idea
6. Other factors that influence your teaching of this idea
7. Teaching procedures (and particular reasons for using these to engage with this idea)
8. Specific ways of ascertaining students understanding or confusion around this idea (include likely range of responses) (Hume & Berry, 2011; p.350f)

In general, we wanted to trigger a conceptual change from students' everyday ideas (referring to pre-knowledge in prompt 5) to an adequate physical concept (prompt 1). Figures 1 and 2 illustrate the pre-knowledge many students bring to physics classes and the educational reconstruction we intended students to acquire about body colours.

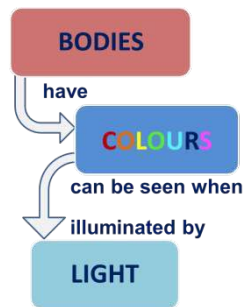

Figure 1. Alternative conception on body colour (adopted from Martinez-Borreguero et al., 2013)

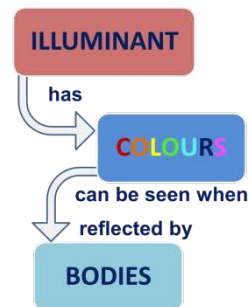

Figure 2. Intended adequate concept about body colour (a. f. Martinez-Borreguero et al., 2013)

As key concepts we focused on the following main ideas:

- We can only perceive an object if we receive light from it.
- Two light colours can be mixed to a new light colour.
- Two light beams can fill the same area in space at the same time.
- We perceive an object in a certain colour, because we receive a certain kind of light.
- The kind of light we perceive an object in, depends on two main conditions:
 - the kind of light we illuminate the body with (=quality of illuminant)
 - the kind of light the body sends off again (=emission characteristics of body).

Why it is important for students to know this (prompt 2) refers to physical contents to come in upper secondary when introducing the wave model of light for example. The issues of the wave model, also represents a limitation of teaching these key ideas (prompts 3 and 4). In addition, this science content is relevant to students' everyday lives in many areas connected to perception and special illumination of objects like manipulative effects in advertising and presenting goods. Difficulties connected with teaching this idea (prompt 4) have already been discussed in the section on students' conceptions and learning difficulties above.

4. Teaching Procedures

This part of the paper refers to the concrete teaching procedures chosen to engage with the ideas reported in the previous section (cf. prompt 7 in CoRes). As trigger for learning processes simple hands-on experiments were used. The experiments presented here should provide students with real colour phenomena and relate these phenomena to processes of selective absorption and reflection. Learning processes were to be initiated by following the propagation and interaction of light, starting from the illuminant (=light source) as far as to the visual system of the observer.

We opted for these hands-on to cognitively activate students and engage them actively, on the one hand. On the other hand, we followed the guidelines of Posner et al. (Posner, Strike, Hewson, & Gertzog, 1982, p.214) for promoting conceptual change: “dissatisfaction with existing conceptions” and the introduction of new conceptions which are “intelligible”, “plausible” and “fruitful”.

As method, the POE (Predict – Observe – Explain) structure (White & Gunstone, 1992; p. 44ff) is used for most cases. Students observe a phenomenon and then they are asked for a prediction for a similar phenomenon or vice versa for the cause of it. After making the observation, the students have to compare their prediction with the observed phenomenon. Then they are provided with an adequate explanation, which is supported by graphical representations. These representations do not only focus on the effect, but they also integrate the sender-receiver model of vision.

5. Light is different

At the beginning, students are asked to peep into a box, where they can see a yellowish light spot. They are asked to predict what is inside the box (Fig. 3).

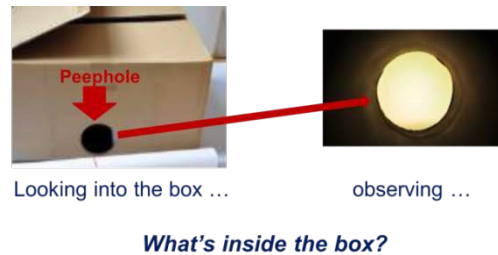

Figure 3. Prediction stage for the key idea: Light can be mixed (Haagen-Schützenhöfer, Rottensteiner, & Fehringer, 2013).

When revealing them the inside of the box (Fig. 4), usually the observation is in conflict with their prediction. Following Posner et al. (Posner et al., 1982), this provides a good basis for introducing the key-ideas: *Light can be mixed. Two light colours mix up to a new light colour.*

What's inside the box?



Figure 4. Observation stage for the key idea: Light can be mixed (Haagen-Schützenhöfer, Rottensteiner, & Fehringer, 2013).

Our previous research (Haagen-Schützenhöfer, Rottensteiner, & Hopf, 2013) has shown that students tend to transfer the concepts they have about the behaviour of material things, to light. So for them it is not obvious that we cannot beam light at a place when there is already light present. This stage of the experiment turns out to also be a good opportunity to discuss the characteristics of light, which do not resemble the characteristics of other things, or material objects. Figure 5 shows a representation conveying the key idea: *Two light beams can be at the same place at the same time. Other substances can't.*

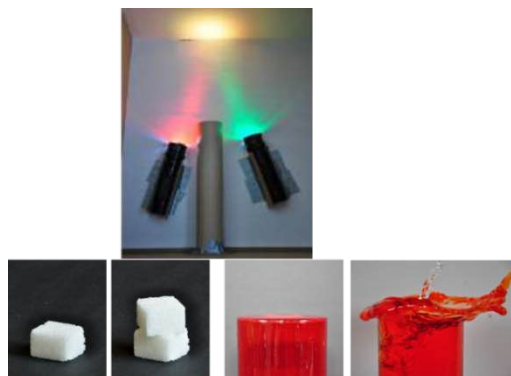

Figure 5. Explanation stage for the key ideas: Light can be mixed. Two light beams can be at the same place at the same time (Haagen-Schützenhöfer, Rottensteiner, & Fehringer, 2013).

6. The Illuminant matters

The next stage of the intervention does not work with the strategy of cognitive conflict as the previous one, but tries to build on students' everyday experiences and directs them into a physical adequate direction. Most students have made the experience that objects do look different when they are illuminated by coloured light sources like in amusement parks, theatres, discos or the like.

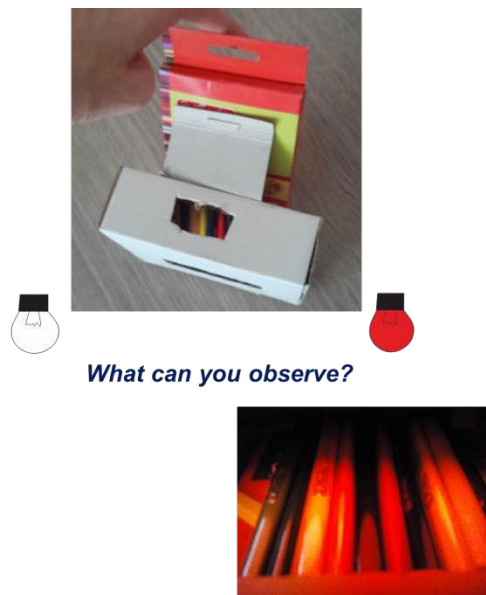

Figure 6. Prediction stage for the key idea: The illuminant matters.

In the setting used, students can experience such a situation in an easy hands-on. Differently kinds of crayons are put into a box with two more windows. One window is used to illuminate the crayons and the second window functions as beep hole for the observer. First the students see through the beep hole when the crayons are illuminated with red light. After describing their observation, they have to predict the differences when illuminating the crayons with white light.

The idea which becomes self-evident is that we cannot perceive the same colours when objects are illuminated with different light colours. At this stage it turns also out to be a good opportunity to discuss that we usually have white light sources like the sun, lamps or torches around us. That is why we are used to this kind of illumination and to the colours such a light source “produces” in combination with objects surrounding us. As a consequence, we tend to believe that objects really “have” the colour we perceive under white light and regard this colour as a fixed characteristic of an object.

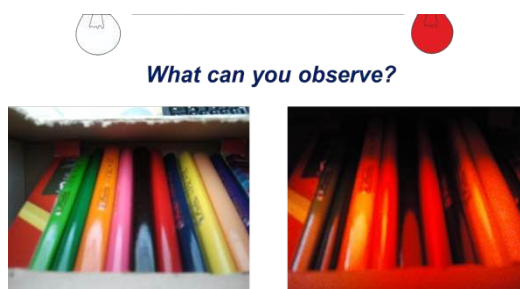

Figure 7. Observation stage for the key idea: The illuminant matters.

Finally, the students are provided with an explanation for their perception. This explanation is based on processes of selective absorption and reflection. One prerequisite for this explanation is the sender-receiver mechanism of vision: *We can only perceive an object if we receive light from it. We perceive an object in a certain colour, because we receive a certain kind of light.*

How can you explain this?

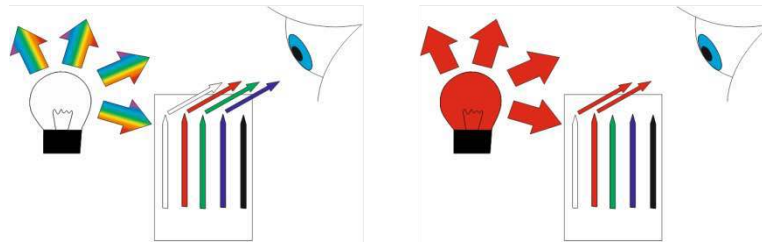

Figure 8. Explanation stage for the key idea: The illuminant matters.

7. The Illuminated matters

The final stage tries to combine the ideas and phenomena of the previous stages. The strategy is again not to work with cognitive conflict but to synthesize the key concepts already prepared. This time the hands-on is based on a white illuminant. The idea is to make the students experience that not only the kind (colour) of the light source matters, but that for colour perception also the object plays a crucial role. Students are usually quite familiar with the idea that different objects “have” different colours. The challenge is now to make them aware of the mechanism that this colour perception is related to the selective reflective behaviour of the object itself.

The hands-on consists of a small box with a window. A torch which emits white light is put through this window, illuminating the bottom of the box. Depending on the piece of paper at the bottom of the box, the observer can see the box being illuminated in different colours. In the concrete example given in Figure 9, this is done with a piece of paper being red under white light and a piece of paper being blue under white light. In a third situation, the students can see the box illuminated in magenta. Then they are asked to predict what kind of paper was put on the bottom of the box this time.



Figure 9. Prediction stage for the key idea: The illuminated matters.

Usually students predict a magenta piece of paper on the bottom of the box. Then they are shown that this is only one possible option and a checkerboard pattern of blue and red squares produces a similar illumination. So, they start searching for a fruitful explanation for this phenomenon.

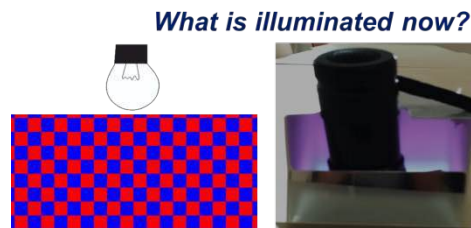

Figure 10. Observation stage for the key idea: The illuminated matters.

The explanation given in Figure 11 turns out to be comprehensible and acceptable: *We perceive an object in a certain colour as we receive a certain mixture of spectral colours from it. The kind of light we perceive from an object depends on two main conditions: firstly, on the kind of light we illuminate the object with (=quality of illuminant) and secondly, the kind of light the object sends off again (=emission characteristics of body). Each body is characterised by the different spectral colours it is able to re(emit).*

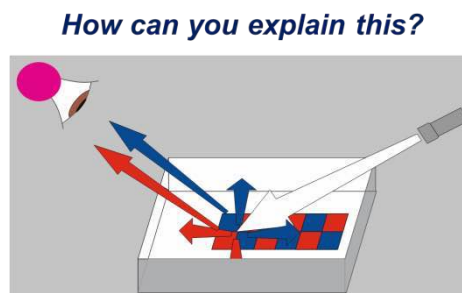

Figure 11. Explanation stage for the key idea: The illuminated matters.

8. Conclusion

Research shows that body colour is one of the most difficult topics within optics. Especially introductory instruction, where the concept of waves is not used, poses a big challenge. This paper introduces a number of easy hands-on experiments which are integrated in an instructional intervention which was designed based on the ideas of CoRes. This learning environment is supposed to trigger conceptual change, so it takes students' alternative conceptions as well as known learning difficulties into account.

The main aim, which seemed to work out fine in the practical testing, was to support students in relating their visual perception to processes of selective absorption and reflection. The technical handling of the experiments did not pose any problems to students. Especially their visual impressions, when observing objects illuminated with other than white light, caused wonder. One reason responsible for the learning effects achieved, may lie in the fact that students always had to reconstruct the way of light from the illuminant via the object being observed (=illuminated) to the observer.

References

- Andersson, B., & Kärrqvist, C. (1983). How Swedish pupils, aged 12-15 years, understand light and its properties. *International Journal of Science Education*, 5(4), 387–402.
- Duit, R., & Treagust, D. F. (1998). Learning in Science-From Behaviourism Towards Social Constructivism and Beyond. In B. J. Fraser & K. G. Tobin (Eds.), *International handbooks of education: vol. 1.*: Kluwer Academic.
- Feher, E., & Meyer, K. R. (1992). Children's conceptions of color. *Journal of research in Science Teaching*, 29(5), 505–520.
- Guesne, E. (1985). Light. In R. Driver, E. Guesne, & A. Tiberghien (Eds.), *Children's ideas in science* (1993rd ed., pp. 10–32). Buckingham: Open University Press.
- Haagen-Schützenhöfer, C., Fehringer, I., & Hopf, M. (2014). Akzeptanzbefragung zu Optikunterrichtsmaterialien: Farben. In S. Bernholt (Ed.): *Naturwissenschaftliche Bildung zwischen Science- und Fachunterricht* (pp. 639–641). Münster/New York: LIT Verlag.

- Haagen-Schützenhöfer, C., & Holzmeier, S. (2013, September). *Wodurch unterscheiden sich Physikschulbücher und forschungsbasiert entwickelte Lernmaterialien zum Themenbereich geometrische Optik?* ÖGFD Poster Symposium, Klagenfurt.
- Haagen-Schützenhöfer, C., Rottensteiner, J., & Fehring, I. (2013). *Unterrichtsmaterialien für den Anfangsoptikunterricht (Sekundarstufe I)*, AECCP, Universität Wien.
- Haagen-Schützenhöfer, C., Rottensteiner, J., & Hopf, M. (2013). Akzeptanzbefragung zu Optikunterrichtsmaterialien. In S. Bernholt (Ed.), *Inquiry-based Learning – Forschendes Lernen* (pp. 431–433). Kiel: IPN.
- Hosson, C. de, & Kaminski, W. (2007). Historical Controversy as an Educational Tool: Evaluating elements of a teaching–learning sequence conducted with the text “Dialogue on the Ways that Vision Operates”. *International Journal of Science Education*, 29(5), 617–642.
- Hume, A., & Berry, A. (2011). Constructing CoRes—a strategy for building PCK in pre-service science teacher education. *Research in Science Education*, 41(3), 341–355.
- Loughran, J., Mulhall, P., & Berry, A. (2004). In search of pedagogical content knowledge in science: Developing ways of articulating and documenting professional practice. *Journal of research in Science Teaching*, 41(4), 370–391.
- Loughran, J., Mulhall, P., & Berry, A. (2008). Exploring pedagogical content knowledge in science teacher education. *International Journal of Science Education*, 30(10), 1301–1320.
- Martinez-Borreguero, G., Pérez-Rodríguez, Á. L., Suero-López, M. I., & Pardo-Fernández, P. J. (2013). Detection of Misconceptions about Colour and an Experimentally Tested Proposal to Combat them. *International Journal of Science Education*, 35(8), 1299–1324.
- Mulhall, P., Berry, A., & Loughran, J. (2003). Frameworks for representing science teachers’ pedagogical content knowledge. *Asia-Pacific Forum on Science Learning and Teaching*,
- Posner, G., Strike, K., Hewson, P., & Gertzog, W. (1982). Accommodation of a scientific conception: Toward a theory of conceptual change. *Science Education*, 66(2), 211–227.
- Viennot, L., & Hosson, C. de. (2012). Beyond a Dichotomic Approach, The Case of Colour Phenomena. *International Journal of Science Education*, 34(9), 1315–1336.
- White, R., & Gunstone, R. (1992). *Probing Understanding* (2006th ed.): Routledge.

Affiliation and address information

Ass.-Prof. Dr. Claudia Haagen-Schützenhöfer
 Department of Physics, Didactics of Physics
 University of Graz, Universitätsplatz 5
 8010 Graz, Austria
 e-mail: claudia.haagen@uni-graz.at

A Superficial Textbook Presentation of the Geneva Lake Experiment for Measuring Sound Speed in Water: Students' Considerations of Coherence Between Textual and Visual Information

Zalkida Hadzibegovic¹, Josip Slisko²

¹ *University of Sarajevo, Faculty of Science, Sarajevo, Bosnia and Herzegovina*

² *Benemérita Universidad Autónoma da Puebla, México*

Abstract

The implementations and role of the history of science in science teaching has been in focus by many science researchers to highlight different variations in its use from the epistemological, pedagogical and sociocultural levels (Matthews, 1994; Monk & Osborne, 1997; Seroglou & Koumaras, 2001; Besson, 2012). Many studies have been conducted to analyze textbooks with historical contents, and to explore how the history of science provides a didactic support for both students and science teachers (Galili & Hazan 2000; Rodriguez & Niaz, 2004; Kokkotas et al., 2009). Being so, it is surprising to find out that there is almost no research exploration on how or what students learn from history-related parts of their physics textbooks. The main aim in this study was to evaluate students' understanding of a textual-visual textbook presentation of the Geneva Lake Experiment (GLE) for measuring sound speed in water (Slisko & Hadzibegovic, 2014) and their development of critical and creative thinking during an active learning session in the classroom settings. The study participants were a group of 121 students from eighth grade (14-15 years old) in Bosnia and Herzegovina two primary schools. A worksheet was created to collect research data to be analyzed. The basic worksheet content is an incoherent physics textbook description of the GLE. The findings give an insight that students involved in the research were able to think critically related to a superficial textbook presentation of the GLE. Students also showed their creative thinking skills by suggesting devices that might play role of the missing elements in the experimental design presented in the physics textbook. There were more than 90% of students who have suggested a keyword for at least one missing elements in the attached worksheet-textbook drawing and they identified incoherence between the textual and visual GLE information. 76% of students have presented their illustrations of different devices for sending a light signal, and 55% of them presented the drawings of a classic chronometer, but 18% of students had applications of different digital chronometers. Research in which students were faced with different tasks related to a superficial textbook presentation of an historical experiment has provided evidence that most of the students are able to think critically, even more than textbook authors who proposed such superficial textbook information. In the same time, the physics teachers need to be prepared to know how they can use some history of science information to create a useful didactic tool to develop students' abilities of critical thinking and creativity.

Keywords

Critical thinking, history of science, measurement of sound speed in water, Lake Geneva Experiment, physics textbook, primary school student.

1. Introduction

History of science and its implementation in science teaching has been put in focus by many science researchers to highlight different variations in its use at motivational, epistemological, sociocultural and conceptual levels (Matthews, 1994; Monk & Osborne, 1997; Seroglou & Koumaras, 2001; Irwin, 2000; Seker, 2011; Besson, 2012). Many studies have been conducted to analyze textbooks with historical contents, and to explore how history of science provides a didactic support for both students and science teachers (Galili & Hazan 2000; Rodriguez & Niaz, 2004; Kokkotas et al., 2009, Seker, 2011). Being so, it is surprising to find out that there is almost no research exploration on how or what students learn from history-related contents in their physics textbooks. An episode from the history of science in physics textbooks

should be used, based on four directions: (1) motivational potential; (2) cognitive adequacy; (3) historical accuracy and (4) didactic basis for learning (Slisko & Hadzibegovic, 2014).

Primary school students in Bosnia and Herzegovina learn science without explicit national science standards how to teach and learn science to develop students' critical thinking skills. The critical thinking (CT) by pedagogical aim is directed to measure students' cognitive capacities that have to be learned to become critical thinkers with developed cognitive skills. CT standards for development of cognitive skills, according to the APA (1990) and NRC (2012), are: (1) interpretation, (2) analysis, (3) evaluation, (4) inference and (5) explanation. Many researchers have claimed that CT considers: firstly, the subject matter understanding by individual thinker, and secondly, the individual skills and abilities for developing individual to evaluate, to analyze and to judge the way how to find the right answers, opinions and argumentation (McPeck, 1981; Siegel 1988; Facione et al., 1995; Golding, 2011).

The main elements of this study are (1) creation and application of a research instrument and (2) classroom pedagogical intervention for students' performance on CT-task, purposely using a textbook content related to the history of science. This study examines how primary school students perform critical thinking (CT) in the classroom learning environment. Students should show several abilities for their successful participation: (1) understanding of a historical episode given textually and visually, (2) separating important facts in the given learning content from unimportant ones, and (3) demonstrating the abilities to present own drawing elements to match a given text and drawing with arguments for expressing their CT about the time compatibility in which Colladon's experiment was realized. It is important to note that this research is the first one using students' drawings to assess validity and didactic role of a textbook textual-visual knowledge presentation.

Main aim in this study was to evaluate students' understanding of a textual-visual textbook presentation of the Geneva Lake Experiment (GLE) for measuring sound speed in water. In the focus of researchers was students' development of critical and creative thinking during an active learning session in the classroom settings (Slisko & Hadzibegovic, 2014). GLE was carried out by Jean-Daniel Colladon in 1826 at Lake Geneva (Colladon, 1893).

The study data were collected from the worksheet student writings. Three research questions were posed and answered:

RQ1: What students can learn from a history-related textbook content about sound?

RQ2: What is level of students' critical thinking performance, presented in their worksheet answers?

RQ3: How did students evaluate learning way of implemented learning session in comparison with their traditional way of learning physics?

2. Method

Participants

The study participants were a group of the 121 eighth grade students who attended two primary schools in two different towns in Bosnia and Herzegovina. The students were 14-15 years old, 58 of them were females and 63 were males. The research-related session was carried out by the first author and lasted 45 minutes.

Research instrument

Research instrument to collect data relevant for this study was a student worksheet, separated into three groups of questions. The basic worksheet content is an incoherent physics textbook description of the GLE. The incoherence is related to the facts that the artistic drawing does not contain various elements superficially mentioned in the textual description of the experiment. These elements, whose detailed description is important for proper understanding of the experiment, are missing in the attached drawing. Related worksheet questions were designed in a way to make possible to explore whether this historical experiment presentation was structured in cognitively adequate way which would give students an opportunity to learn about the nature of physics and to show students' potential for critical and creative thinking.

Worksheet part I

This part contains information for study participants in both textual and visual form as following.

A physicist and his assistant were in two boats 1,500 m away from each other. A bell on a rope was immersed in the water from the first boat with the assistant in it. His task was to hit the immersed bell with a hammer and simultaneously send a light signal. The physicist with a long horn was in the second boat. One end of the horn was immersed in water, while the other end of the horn was held by the physicist near his ear. The moment he saw the light signal, the physicist switched the chronometer on and

measured the difference of time between the moment he saw the light and the moment he heard the sound. The delay of the sound signal was one second. The physicist concluded that the sound needed one second to travel 1,500 m through water, and that the speed of sound in water was 1,500 m/s.

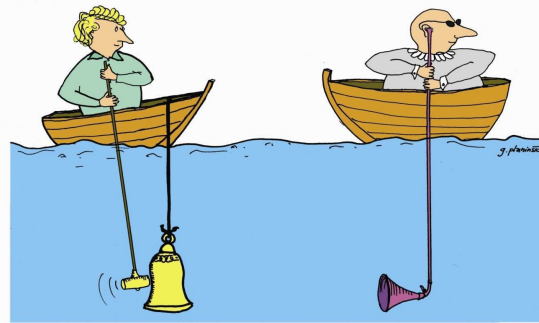

Figure 1. Attached the textbook drawing about Colladon's experiment.

First question posed in this worksheet part was:

Q1) Which parts of the text are not shown on the attached drawing?

Worksheet part II

This worksheet part contains four questions for collecting students' answers:

Q2) Have you noticed in the attached drawing that is not represented the way of sending a light signal?

Q3) Have you noticed in the attached drawing that is not shown an instrument for time measurement?

Q4) Please, provide your idea of a light signal sending during GLE?

Q5) Please, provide your idea of a sonic signal sending during GLE.

Worksheet part III

In this worksheet part, there is a question for getting the student evaluations of in-class activities:

What is your opinion about the today learning experience?

Worksheet scoring scheme

The grading worksheet rubrics as a basis for quantitative result analysis are presented in Table 1 (based on seven possible points). For each scoring item that Table 1 shows, students under this study could earn one points. Student answers according to the Q2 and Q3 are not included in this scoring scheme, leading to a qualitative dimension of research data analysis.

3. Results and discussion

The findings provide evidence that students involved in this study were able to think critically related to a superficial textbook presentation of GLE. Students also showed their creative thinking skills by suggesting devices that might play role of the missing elements in the experimental design presented in their physics textbook. Average achieved number of points was 3.5 or 50% of seven possible points. Table 1 shows percentages of student numbers according to the scoring items established by the researchers.

Table 1. Worksheet rubrics with grading points and students' scores.

WS part and question	Student answers about missing elements of given drawing	Point	Number of students (%)
WS part I			
Q1	Any device for sending light signal from the first boat (like lamp, candle, sun-mirror system).	1	76
	Any instrument/device for time measurement placed in the second boat.	1	79
	Sound speed value of 1500 m/s.	1	4
	Sound wave representation in sinusoidal shape.	1	3
WS part II			
Q4	Own drawing of a device for sending light signal.	1	85
Q5	Own drawing of an instrument for time	1	61

measurement.		
	WS part III	
Showed learning experience emotionally colored.	1	98

Although the students were asked to provide their answers for each worksheet question (Q1- Q5), around 20% of students didn't do so. Some of them wrote down simply "I do not know" or left empty space for the answers, without any information about the reasons they were unable to give their answers. The researchers have not expected any sound wave visualization by the students in a sinusoidal shape, because they did not learn such mathematics content at primary school level. To take into account this student contribution, the researchers decided to include one point of a total score, because several correct sound wave visualizations were found. Evidently, this is out-of-school knowledge gained from different informal learning sources. It is important to stress that only 4% of students considered the sound speed value written down on their drawings. The students did not find this detail as important one, even it was included in the worksheet information.

Q1 student answer analysis

Among 121 students, five student groups were established, according to the number of found missing elements in accordance of textual and visual information given in the worksheet used during data collection.

Group 1 (6% of students): the students who identified three missing elements (a device for sending light signal, a device for time measurement and representation of sound wave in sinusoidal shape);

Group 2 (64% of students): the students identified two missing elements (device for sending light signal and instrument for time measurement);

Group 3 (12% of students): the students identified only a device for sending light signal as missing element;

Group 4 (15 % of students): the students identified only device for time measurement.

Group 5 (9 % of students): the students without any answer.

The researchers expected that only some students could be able to perform as in they did in the *Group 2*, namely, that the some students might note that the devices for sending light signal and time measuring were omitted on the textbook drawing. Surprisingly, more than 60% of students were found with two missing elements identified. This is a more than satisfactory number of students, because they were not prepared for such an in-class activity implemented during the research session. Nevertheless, students that did not give their answers to the Q1 should be under physics teacher's consideration and a way sought to increase their participation in similar tasks carried out in the classroom learning environment. Some thoughts selected among students' attached to Q1 answers are following:

In the attached figure has a missed element concerning how assistant was sending a light signal. Here it is not shown a chronometer that was used by a physicist for timekeeping.

There is a mirror as missing and chronometer as missing, too. I'd drawn how an assistant holds in one hand a mirror and in his second hand a hammer for striking the bell. I'd drawn in the second boat a physicist who has a chronometer in one hand and in the other hand he holds the long horn.

In the picture, in my opinion, there is not anything missing. At that time they did not have equipment to measure and perform such an experiment. Probably, they had a timepiece. I do not know how they could send a light signal from the boat.

In my opinion, the attached picture lacks the chronometer to measure speed of sound. One can't see sound waves under water travelling to the horn.

Here a timepiece is missing. I can't understand how a physicist had been involved to measure only one second of time interval with any timepiece.

I do not know how I can show that the scientist saw the light signal and then turned chronometer and then turned it off when he heard the sound by horn. How sound was late for one second according to the light signal?

Q2 and Q3 student answer analysis

The students' answers to the Q2 and Q3 are presented in Table 2.

Table 2. The students' Q2 and Q3 answer statistics.

Question	Student answer	Number of students (%)
Q2	YES	83
	NO	14
	I do not remember	3
Q3	YES	87
	NO	11
	I do not remember	2

Comparing the data in Table 1 and Table 2, it can be seen that there was a group of students (around 5% of them) that showed their honesty and self-critical thinking, more or less, after the Q1 answering.

It is important to notice that the researchers provided a worksheet part with Q2-Q5 questions as separated sheet and after the Q1 answers were collected.

Q4 student answers analysis

The Q4 (*How do you imagine a way in which the assistant sent a light signal to the physicist in the second boat?*) should provide the student answers related to their thinking and historical information which device could be used in that time for sending a light signal (LS) from the first boat. 53% of students with attached drawings were classified by the researchers into five groups, according to the devices they provided. These groups are as follows:

- LS-A: an electrical lamp (35% of students);
- LS-B: a sun-mirror system (17% of students);
- LS-C: a candle (6% of students);
- LS-D: signal pistol (4% of students);
- LS-E: a laser pointer (2% of students).

Other 47% of students did not attach their drawings. Some of them wrote a short sentence "*I do not know*" down. More interesting are the students who gave their answers implicitly in the texts. The student knowledge, thinking and emotions that were verbally expressed are presented by 5% of students in the following way:

I do not know how to draw a missing lamp or mirror for sending light by the physicist.

Only 2% of students did not reconstruct the historical episode about GLE in a proper way. They gave an answer, using a laser pointer as a device for sending a light signal for presenting the Colladon's measurements. The student drawings, showed in Figure 2, are in accordance with above-mentioned Q4 answer classification: students presented a light source and light signal from it or solar light beam reflected by a mirror.

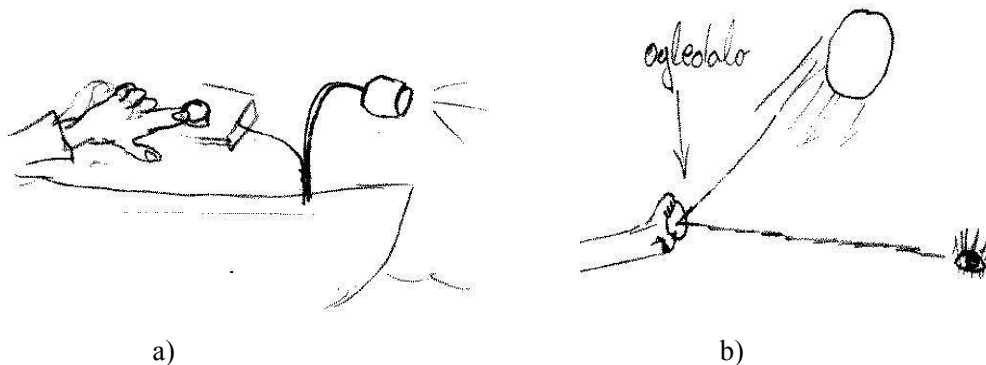

Figure 2. a) A student drawing of an electric lamp switched on; b) A student drawing of the sun-mirror system (a written word is “mirror”).

Therefore, if one thinks about use of first electrical lamp (an incandescent lamp was invented by Thomas A. Edison in 1880), it can be considered as a historically incoherent detail taking into account the time of the Colladon’s experiment realization (in 1826). It might be a consequence of curricular fact that students in Bosnia and Herzegovina learn about electricity and magnetism in the ninth grade of primary school. More expected idea about a possible device that was used for sending light signal is a student’s example of use a mirror that reflects the Sun’s beams that go into the experimenter’s eyes.

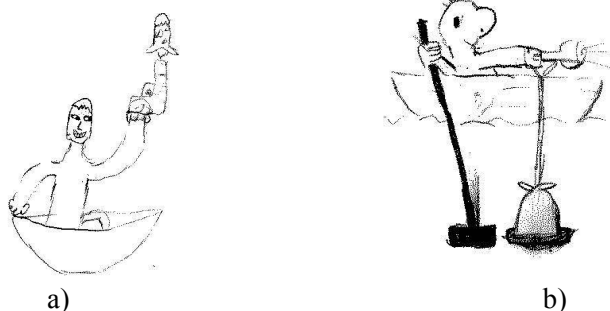

Figure 3. a) A student drawing of a light pistol as light signal device; b) Student’s imagination of assistant involvement to measure sound speed in water.

Two students were presenting that the assistant sent light signal using a signal-red light pistol or a special handgun (Figure 3.a). Eight students considered that the assistant was holding in one hand a hammer and in the other hand he had a lamp to send a light signal (Figure 3.b).

Among several inadequate student drawings is one where a lamp is in the right experimenter hand placed in the second boat as a wrong place of the Colladon’s experiment performance (Figure 4.a). Other similar inadequacy is an electrical circuit with a bulb placed under water and without persons’ corporal details except their eyes (Figure 4.b). Probably, the students did not read carefully the given textual information in the worksheet or they had a misunderstanding of the information about GLE.

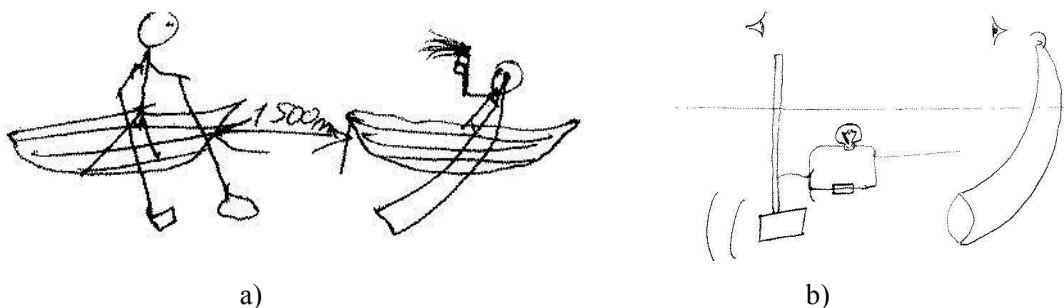

Figure 4. Two examples of inadequate students’ drawings.

Among 121 research participants were 19% of students who suggested that GLE was realised as a daylight measurement, but 6% of students gave a notions that it was carried out at night. According the original experiment's details, it was performed at night (Slisko & Hadzibegovic, 2014).

Q5 student answers analysis

Question about a possible instrument used for time measurement is the Q5 content and visual student answers. In total, the 73% of students attached their drawings that are categorized, according to the type of timer (T), into five categories:

- T1: mechanical stopwatch/analog chronometer (55% of students);
- T2: digital stopwatch (18% of students);
- T3: wristwatch (4 % of students);
- T4: pendulum (2% of students);
- T5: sand timer (1% of students).

Without any attached drawings were 21% of students. Some of them (three students) gave their comments related to counting by second experimenter as a possible way to measure a time interval.

*I guess that physicist counted from the moment he saw the light until the moment when he heard the bell.
Perhaps he had in his hand a chronometer.*

Several typical examples of students' drawings according to the T1, T2 and T3 type of timers is presented in Figure 5.

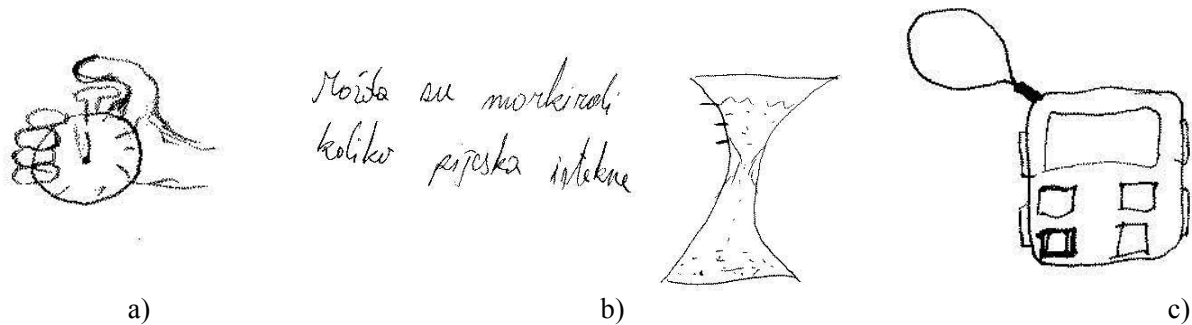

Figure 5. Students' drawing of the instruments for time measurements: a) mechanical stopwatch (chronometer); b) sand timer; c) digital stopwatch.

Note: The text translation from Bosnian into English in b) drawing is following: "Maybe they were marking how much sand leaked out".

Backward technology thinking was found (counting, sand timer) as well as thinking about inappropriate instruments for measuring the time intervals of sound travel (digital stopwatch for example). The students learned about time measurement in the seventh grade, about different instruments (timers) and time units. How their physics teachers were presenting historical evidences about timekeeping was not under research focus, but one can see that the study participants were not in knowledge coherence about this learning topics.

Several selected students' answers given verbally according to the Q5 are presented as following:

In the attached drawing there is a lack of chronometer, but I can not understand how to operate the instrument if the physicist holds the horn with both hands.

For me it is not quite clear how they used a chronometer in the 19th century.

How is it possible to send both a sound and light signal in the same time by the same assistant?

Attached worksheet drawing does not match the text that has been given. I think it would be good if it appears in the textbooks and drawings or pictures should be 100% correct in relation to the narrative attachment.

No representation of sound in the attached drawing, but I think it is needed to be seen.

Summarizing the data, it is found that only 13 % of students presented both their drawings of devices for light signal sending and their drawings of the time measurement instruments or ways to record the time intervals.



Figure 6. A male participant presentation of GLE settings as a comic illustration.

Explanatory labels are: Assistant (left boat) thinks: „When I hit this bell... hi hi hi”. Physicist (right boat) thinks: “One second late O.O.O.” In the upper right corner, it is written: “Conclusion: the speed of sound in water is 1500 m/s”. Under his timepiece is written “STOP”, and above the ring assistant it says “TRAS (meaning strong kick)”.

4. Impressions of students regarding the carried WS activities

Students were asked to express opinions about their learning experience during the GLE-related research session. In total 95 % of them were with positive, and 3% of students were with negative opinions. The students believed that an active engagement in the classroom is the best way for learning and teaching science in general. Four students answered that did not like to draw anything because they are not smart enough to present their drawings. Only 2% of students did not give their opinions or their emotions. Opinions and emotions, expressed in selected answers of several students, are the following:

I'm happy that I was drawing well, not only a lamp for sending a light signal but also a chronometer.

I'd like to have our class meeting as this meeting today. This way of teaching is very interesting and I was not afraid to say my opinion.

I do not like my physics class because it is very difficult class for me. I do not know well how to solve some problems in physics, but this day it was very nice. I like it and I would like to have more similar activities and to do something real with my physics teacher.

During this research, it was discovered that some students hold alternative conceptions related to sound and its speed. As students' these aspects were not among research aims, it should be left as an interesting future topic. Nevertheless, it can be considered that the students did not learn enough from such presented historical episode about sound nature and sound speed dependence of the medium. In the case of the Lake Geneva Experiment, that is presented in a textbook used in Bosnia and Herzegovina, one can find information being both historically erroneous and cognitively inadequate (Slisko & Hadzibegovic, 2014). Slisko & Hadzibegovic (2014), analyzing similar research data but realized with different research instrument, highlighted that “the above textbook presentation of the historical experiment in which the speed of sound in water was measured is:

- (1) Historically inaccurate (the values of the distance and time are arbitrarily invented);
- (2) Depersonalized (Colladon became an anonymous physicist); and
- (3) Cognitively inadequate (neither the text nor the drawing gives students an opportunity to comprehend fully how the experiment was carried out).”

According to the level of students' performances presented in the worksheet answers the RQ2, their critical thinking skills can be seen in a positive light. The students were more critical thinkers than the textbook authors and reviewers who left some significant errors about the GLE information. The most number of students were able to discover two missing elements in the presented drawing that appears after a text about the GLE presented in physics textbook for primary school students. The students gave very positive

evaluation of implemented in-class activities that they would like to meet more in their learning environment.

5. Conclusion

The findings give an insight that students involved in the research were able to think critically related to a superficial textbook presentation of the GLE. Students also showed their creative thinking skills by suggesting devices that might play role of the missing elements in the experimental design presented in the physics textbook. There were more than 90% of students who have suggested, at least, one keyword to identify missing elements in the attached worksheet-textbook drawing that appeared after the text about the GLE.

The students identified incoherence between the textual and visual GLE information. 76% of students have presented their illustrations of different devices for sending a light signal, and 55% of them presented the drawings of a time measurement instrument (classic chronometer), but 18% of students had applications of different digital chronometers.

This research, in which students were faced with different tasks, related to a superficial textbook presentation of an historical experiment, has provided evidence that most of the students are able to think critically, even more than textbook authors who proposed such superficial textbook information. At the same time, the physics teachers need to be prepared to know how they can use some history of science information presented in used textbooks or be informed by researchers how to use wrong or inaccurate historical information to create a useful didactic tool to develop students' abilities of critical and creative thinking (Campanario, 2006).

Acknowledgement

We are very grateful to Prof. Gorazd Planinšič (University of Ljubljana) for his artwork in Figure 1.

References

- American Philosophical Association/APA (1990). *Critical thinking: A statement of expert consensus for purposes of educational assessment and instruction*. Mallibae: California Academic Press.
- Besson, U. (2012). The History of the Cooling Law: When the Search for Simplicity can be an Obstacle. *Science & Education*, 21(8), 1085-1110.
- Campanario, J. M. (2006). Using textbook errors to teach physics: examples of specific activities. *European journal of physics*, 27(4), 975 - 981.
- Colladon, J.D. (1893). *Souvenirs et Memoires*. Geneva: Albert-Schuchardt.
- Facione, P.A., Giancarlo, C.A., Facione, N.C. & Gainen, J. (1995). The Disposition toward Critical Thinking. *Journal of General Education*, 44(1), 1-25.
- Galili, I. & Hazan, A. (2001). The Effect of a History-Based Course in Optics on Students' Views about Science. *Science & Education* 10(1-2), 7-32.
- Golding, C. (2011). Educating for critical thinking: thought - encouraging questions in a community of inquiry. *Higher Education Research & Development*, 30 (3), 357-370.
- Irwin, A. R. (2000). Historical Case Studies: Teaching the Nature of Science in Context. *Science Education*, 84(1), 5-26.
- Kokkotas, P., Piliouras, P., Malamitsa, K., & Stamoulis, E. (2009). Teaching Physics to In-Service Primary School Teachers in the Context of the History of Science: The Case of Falling Bodies. *Science & Education*, 18 (5):609-629
- Matthews, M. R. (1994). *Science teaching: The role of history and philosophy of science*. New York, London: Routledge.
- McPeck, J. (1981). *Critical thinking and education*. Oxford: Martin Robertson.
- Monk, M., & Osborne, J. (1997). Placing the history and philosophy of science on the curriculum: A model for the development of pedagogy. *Science Education*, 81(4), 405-424.
- National Research Council/NRC (2012). *A Framework for K-12 Science Education: Practices, Crosscutting Concepts, and Core Ideas*. Washington, DC: The National Academies Press.

Rodriguez, M. & Niaz, M. (2004). The oil drop experiment: An illustration of scientific research methodology and its implications for physics textbooks. *Instructional Science*, 32 (5), 357-386.

Seker, H. (2011). A Facilitator Model for the Use of History of Science in Science Teaching. *Journal of Turkish Science Education*, 8(3), 59-68.

Seroglou, F., & Koumaras, P. (2001). The contribution of the history of physics in physics education: A review. *Science & Education*, 10 (1), 153-172.

Siegel, H. (1988). *Educating reason*. New York: Routledge.

Slisko, J. & Hadzibegovic, Z. (2014). History in Bosnia and Herzegovina Physics Textbooks for Primary School – Historical Accuracy and Cognitive Adequacy. In M.R. Matthews (Ed.) *International Handbook of Research in History, Philosophy and Science Teaching*, Springer, Dordrecht, pp. 2119-2147.

Affiliation and address information

Zalkida Hadzibegovic
Faculty of Science
Department of Physics
University of Sarajevo
Zmaja od Bosne 33-35
71000 Sarajevo
Bosnia and Herzegovina
e-mail: zalkidah@yahoo.com

Josip Slisko
Benemérita Universidad Autónoma da Puebla, México
Laurel #2, Colonia El Mirador de la Calera
72520 Puebla
México
e-mail: jslisko@fcfm.buap.mx

On the Verdict of the German Physical Society Against the *Karlsruhe Physics Course* – a Chronicle of Events

Friedrich Herrmann, Michael Pohlig

Karlsruhe Institute of Technology, Karlsruhe, Germany

Abstract

The *Karlsruhe Physics Course* (KPC) is a novel approach to the teaching of physics at the secondary school. It was developed more than 30 years ago. The KPC textbooks have since been used in a certain, slightly increasing number of German schools. Simultaneously, ideas of the KPC have found their way into the mainstream textbooks. Only recently, the German Physical Society (DPG) got aware of the course. In their opinion the KPC represents a danger to the teaching of physics. Therefore, the DPG nominated an expert panel with the assignment of finding scientific errors in the KPC. The panel believed to have found such errors. Thereupon the DPG has initiated a campaign with the objective of eliminating not only the KPC textbooks from the market but to eradicate any other manifestation of ideas that might have originated in the KPC work. The DPG did so not only in Germany but worldwide. Among other things, the DPG alerted the European Physical Society and the Chinese Physical Society. As a result of these measures, a discussion of unusual fierceness arose, first in Germany, but then spreading to other countries. Thereby the physics community got more and more polarized. A chronicle of an eventful year and a brief evaluation will be given from the perspective of the author of the course and of a teacher who uses the KPC in his classes.

Keywords

German Physical Society, Karlsruhe Physics Course

1. Introduction

It is our intention, to inform about some events that have shaken the physical community in Germany and that have also emanated into some other countries; we believe that they concern all of us physics educators.

It is an attack of the German Physical Society (DPG) against a teaching concept developed by our group, the Karlsruhe Physics Course (KPC) [1,2]; it is an attack against a large group of scientists and teachers, but it is also an attack against the whole community of physics education researchers.

2. The genesis of the KPC

The development of the KPC began in 1975. At that time the *Nuffield course* and the *PSSC* existed already. Our ambition was to develop a new physics course, to modernize the teaching structure or doctrine of physics, in the first place not for a particular group of addressees. That is why the first tests of each subfield that we were occupied with, was not with a school class, but with university students of physics. Thereafter, we simplified, shortened, boiled down the course for the higher and the lower secondary school. Only in this way it was assured, that the school version could serve as a solid basis for any follow-up course. Here briefly some characteristics of the KPC.

- Today's science curriculum is the result of a process of evolution. It reflects the historical development of the physical science in great detail. Those who are learning science have to follow a path that is similar to the course of the historical development. Our students have to take detours, to overcome unnecessary obstacles and to reproduce historical errors. They have to learn inappropriate concepts and employ outdated methods. When developing the KPC we have tried to eliminate such obsolete concepts and methods.
- The KPC makes use of analogies. The most important one is an analogy based upon the extensive quantities: Electric charge, momentum, entropy and amount of substance.

As a result the KPC is more compact than traditional courses. We also believe that it is easier to learn physics with the KPC. All the conceptual changes that were used in the KPC have been published [3],

mainly in the *American Journal of Physics* [4-9] and in the *European Journal of Physics* [10-16]. Many details have been presented at previous GIREP meetings.

When developing the Secondary school version, every subject and every new idea was tested at school by ourselves under real class room conditions. A version for the lower secondary school was ready in 1988. At that time we began with a test of the course at 20 selected schools, which lasted 3 years. The test procedure was supervised by the Ministry of culture of the Federal State of Baden-Württemberg. The test was satisfying in every respect. The school authority had looked in particular if there are problems when a pupil changes from a KPC class to a traditional class and vice versa. In 1994 a new official curriculum entered into force, which contained a special clause that allowed every school to use the course upon application.

In the years from 1996 to 2001 the KPC was evaluated in a PhD theses at the IPN at Kiel (Leibniz Institute for Science and Mathematics Education) [17].

In 2004 finally it got the definite approval as a schoolbook in Baden-Württemberg. In the following years ideas of the KPC entered the new education standards; textbooks of other authors took over KPC ideas.

The course was translated into foreign languages, among them Italian, English and Chinese.

3. The reception of the KPC

How did the various communities receive the KPC ideas?

There are teachers, at school and at the University, who do not like changes of the basic concepts. In political terms one would call them *conservatives*. There are other colleagues who see the deficiencies of the traditional curricula and who are more open for innovations. Let us call them the *reformers*. In the case of the KPC a very strong polarization between these two groups developed. On one side there were the passionate supporters, on the other there were the equally passionate opponents. But the intensity of the reactions, the emotionality of both sides has surprised us a lot. Let us consider the reactions of four different groups or communities.

1. The secondary school scene, i.e. school teachers and teacher educators.

Here, a fierce discussion was going on in the nineteen-nineties. Finally in 1998, the MNU, our association of science teachers, organized a symposium: A dispute between conservatives and KPC defenders. Each of the two groups was represented by one theoretical physicist from the University, one experimentalist, one school specialist and so on. A protocol was written and published in the Web, where it still is [18]. This symposium had attested that the KPC does not contain scientific errors.

2. The educational branch of the DPG.

Here, the KPC was known more or less. Not all of the colleagues were enthusiastic about it. In the terms mentioned above, one would classify most of them as conservatives. The majority of them is working on less offensive subjects. Some made us feel that we not really belonged to them, since what we made is in their eyes rather physics than physics education.

3. The much greater non-educational part of the physics community.

The general physics community did not know our work. Why should they? Only some of them, mainly former students of the author of the KPC, knew the KPC. Some of them had become university professors in the meantime and they used KPC ideas in their lectures. Others had heard about our work and they took a rather clear position: "I know how to teach physics, I do not need recommendations from the educational people."

4. Other countries.

The KPC work got also known in other countries, at the beginning mainly in several latin-american countries, like Chile, Argentina and Colombia. In Europe it got known mainly in Switzerland and Italy, and since about 10 years it was tested and introduced at some Chinese schools. Recently it got the approval as an official schoolbook in the province of Shanghai.

4. The report of the DPG

In 2011 the DPG elected a new executive board. Apparently, members of the board had been alerted by opponents of the KPC about the spread of the course. The board got aware, that the KPC is not simply one among many other school projects. They discovered that the KPC has found a considerable resonance at schools. They got aware that there must be physics students at their own faculties who have been educated by teachers with a KPC background. And they discovered that KPC ideas have found their way into the official school curricula; they also got aware that teacher educators were spreading the ideas and that KPC

ideas have made their way into the mainstream textbooks.

From the beginning they were convinced, that the KPC contains scientific errors. The logic might have been like this:

“The KPC is different from what I am teaching; what I am teaching is correct; thus the KPC is not correct.”

Therefore, the DPG board nominated an “expert panel” consisting of 13 persons. The assignment of the panel was to search for errors in the KPC. Its composition was somewhat unusual: Four of the members were members of the DPG board, in other words, they nominated themselves. One of the panel’s members was an Ombudsman of the DPG, who, according to the statutes of the DPG should not take upon any other activity: *“The ombudsmen and ombudswomen may not exercise any other function in a DPG body during their period of office, so that they are able to reach their decisions with a maximum of independence.”* It is also conspicuous that none of the members came from the educational section of the DPG. On the contrary, the educational colleagues were accused, that they had not recognized the danger that the KPC represents, and that they had not “alerted” the directory board of the DPG.

So, the panel members looked for mistakes, and they were successful – at least that is what they believed. They published their report in the Internet on February 13, 2013 [19]. A letter dated the same day was sent to the author of the KPC.

Our first reaction was an immediate relieve. After reading the report, it was clear that none of the allegations could be substantiated. Most of the claims of the DPG experts were based on ideas that are scientifically incorrect, others accuse the KPC to contain statements that it does not contain. It was obvious, that the DPG experts had not taken the time to study the KPC carefully. Moreover, the wording of the report was insulting. Every innovative idea of the KPC had been published previously in one of the great international peer-reviewed journals. None of these publications was mentioned in the report, and apparently none of the experts had read any of them.

Several of the allegations refer to ideas that can be found in prestigious textbooks, like Landau-Lifshitz or Feynman. Several allegations refer to ideas that had originally been published by scientists like Maxwell or Planck. The report makes no reference to this work, although it is in contradiction to it.

Although the report is long and it is rather difficult to follow the twisted thoughts of its authors, it can be seen that the problems they see, are mainly based on a general misunderstanding. The DPG experts confuse two concepts: that of a physical quantity and that of the object or system described by the quantity. In other words: they confuse theory and reality.

There are three main allegations and we will discuss them briefly.

1. Force as momentum flow

In mechanics, the primary quantity in the KPC is momentum. Consider two bodies A and B, that are connected by a spring. When the momentum of A increases at the expense of the momentum of B, the traditional wording is: A exerts a force on B and B on A. The KPC description is: momentum is going or flowing from B to A.

Here the opinion of the DPG panel:

“This current does not exist in nature. For this reason the KPC momentum current has no place in the existing framework of physics and most certainly not in physics classes.”

Notice, that with this claim, the DPG panel members not only call into question the KPC. In the first place they disagree with Max Planck, who, in 1908 introduced the concept of momentum flow. We quote from Planck [20]:

“As the constancy of energy entails the concept of an energy flow, the constancy of the quantity of motion necessarily entails the concept of the flow of the quantity of motion, or for short the ‘momentum flow’.”

The DPG report is also in disagreement with some of the best University textbooks, as for instance Landau-Lifshitz [21,22].

2. Entropy and the colloquial concept of heat

At the beginning of the chapter about thermodynamics, on the second page, KPC says:

“What we call ‘quantity of heat’ in everyday language, has a special name in physics. It is called *entropy*. The symbol used for entropy is S ...”

And here the objection of the panel:

“It is true that the entropy of a system can be changed by supplying or removing heat. But entropy is by far not the same as heat, and cannot be referred to as such, not even ‘colloquially’. Both have different measurement units, simply for this reason they cannot be identical. Heat is measured in Joule, entropy in Joule / Kelvin.”

Our answer: The colloquial heat has no unit, it is not measured in Joule.

And later the panel:

“KPC’s assertion that entropy is ‘colloquially called heat’ is wrong and misleading in a particularly blatant manner...”

Notice the wording. The style of the whole document is pretentious, aggressive and insulting.

Yet another quotation from the report:

“It is well-known that entropy is one of the most difficult physical quantities.”

This is indeed a widespread opinion. However, the opposite opinion is also widespread. Let us quote the British physicist *Callendar*, from the Royal College of Science. In 1911 he wrote [23]:

“Finally, in 1865, when its importance was more fully recognised, Clausius gave it the name of ‘entropy’, and defined it as the integral of dQ/T . Such a definition appeals to the mathematician only. In justice to Carnot, it should be called caloric, and defined directly by his equation $W = S (T - T_0)$, which any schoolboy could understand. Even the mathematician would gain by thinking of caloric as a fluid, like electricity, capable of being generated by friction or other irreversible processes.”

3. Magnetic charge

The KPC operates with the physical quantity magnetic charge. Here the opinion of the DPG experts:

“Contrary to this experimentally verified fact, [...] the KPC assumes in the textbook [...] the existence of magnetic charges“

Magnetic charge was introduced by Maxwell in his *Treatise* [24] and it is also introduced in other text books [25]. Sometimes it is called magnetic pole strength. The quantity is needed in order to express quantitatively the fact that a magnet has two poles which in its action are equal and opposite: Each pole carries magnetic charge; the amounts are equal, the signs are opposite. The quantity is also needed in order to express the fact that no magnetic monopole particles exist.

In this context, the teacher’s manual of the KPC explains, that physical quantities are creations of the human mind. This statement is commented by the DPG referees as follows:

“Now this is an argument which discredits completely the action of the KPC in the eyes of reputable scientists. This is an evident example of how the KPC bends basic physical facts in favor of didactic convictions.“

So far the report. It had been published in the internet, but this was only the beginning of a large campaign.

5. The measures of the DPG

Ministries

On March 1, 2013 the president of the DPG writes letters to the ministries of culture and education of all the 16 German federal states, from which we quote:

“The Karlsruhe Physics Course is unsuitable for use in schools and will cause damage if its diffusion continues.... The German Physical Society believes, therefore, that the Karlsruhe physics course may not be used to teach physics in school or as a guideline for the formulation of physical education or training plans.”

Also on March 1, the president of the DPG asks the deans of the physics departments of the German

universities, not to comment on the KPC case:

“Hereby we would like to inform you about the report, since it may be that you are asked questions about it from various sides. At the same time I ask you not to become active independently, so that the measures of the DPG on the political level and regarding the public relations can be concerted.”

The European Physical Society

On April 5 the European Physical Society (EPS) is informed by the German delegate to the EPS council, who simultaneously is a member of the DPG-KPC panel. He warned the EPS council against the KPC. To do so, he had prepared a PowerPoint presentation. We cite from the last slide:

“Please contact me or the DPG office if you notice that KPC based teaching is used at your schools or universities. DPG will supply you with the necessary arguments and materials to counteract this development which is damaging to the reputation of our field and to the necessary improvement of Physics teaching at all school levels.”

Apparently, the German delegate does not trust in the physical competence of his European colleagues.

The Chinese Physical Society

On April 12 the president of the DPG warns the president of the Chinese Physical Society:

"The findings [of the report] point to substantial mistakes contradicting our internationally established knowledge of physics. The panel strongly recommends that the course should not be used for teaching physics at schools. I have been informed that the course is now also in use in your country, for example at the Jinshan-School in Shanghai. ...“

The president appended to this letter the ppt slides that was mentioned just before and that had been used to inform the European Physical Society.

Ombudspersons

Since in our opinion the DPG had infringed the rules of good scientific practice, we wanted to address to an ombudsperson of the DPG. There are two of them. The first one was out of question, because he was a member of the KPC panel. So we addressed to the second one, a Lady. First, she did not answer to two of our e-mails. Finally we succeeded getting her on the phone, where she told that this was not the right way to open a procedure. If she is to occupy with a case, the initiative has to come from the directory board of the DPG. After explaining her that the Board was one of the contentious parties, she reluctantly promised to look at the case. Soon after, we received an e-mail, where she said, that the case was not a case for the Ombudsperson. But in addition, she wrote some words of consolation:

“From my point of view, here is a controversial discussion about the KPC - comparable to the critical review of a book.”

6. The damage

Our publisher (the AULIS-Verlag) had just prepared a new improved edition of some of the volumes of the KPC. However, on April 4, before the new books appeared in print, the author of the KPC was advised that the publisher discontinued the cooperation.

Some years ago the KPC had been translated into Chinese. It had been tested in some selected schools. The teachers had been trained by us. Every year we passed some weeks in Shanghai. Reports about the experience with KPC teaching had been written and several symposia had been organized. After the test had been considered a success, it was decided to make a new KPC type book, written by Chinese authors: a version that fits better into the Chinese educational system.

Just like in our country, every new schoolbook has to be approved by the school authority. This certification process was just beginning, when the letter of the president of the DPG arrived. Thereupon, the certification process was discontinued.

7. First reactions

School teachers, teacher educators, university professors

The publication of the DPG report triggered an avalanche of responses, statements, comments, letters of protest, resolutions, collections of signatures. All of them demand the withdrawal of the DPG review.

It was the subject at many meetings, and meetings have been specially organized to discuss the affair: faculty

councils, a meeting of the deans of the German physics faculties, meetings of teacher educators, of the educational section of the DPG.

The protest came from various communities: School teachers, teacher educators, University professors. A great part of the material has been published in the internet [26].

The educational section of the DPG

The members of the educational section of the DPG not only disagree about the DPG measures against one of the most innovative educational projects, they also feel duped, since the DPG had assigned a commission to assess an educational project, in which none of the specialists of education was present.

The European Physical Society

The DPG had also alerted the European Physical Society (EPS). We have mentioned above the PowerPoint file that had been used to inform the committee.

The president of the EPS has addressed a letter to the national physical societies.

The author of the KPC wrote an e-mail to him asking, if there is an official reaction of the EPS, and he answered:

“The EPS has not published an official position on the Karlsruhe Physics Course (KPC). Nonetheless, we did commission an independent review of the KPC, which is in broad agreement with the position of the DPG. The EPS Executive Committee has expressed its support to the DPG for its handling of the matter.”

The KPC author asked the president of the EPS to give him, the person that is most concerned, access to this review, but the EPS president did not answer anymore.

Miscellaneous reactions

Several persons terminated their membership of the DPG, among them several University professors. Some colleagues wrote scientific articles in support of the KPC concept.

Many persons expressed their concern in e-mails that they sent to the author of the KPC, and they sent letters of encouragement. In several of these letters the sender formulated: “I am ashamed to be a member of a society...”

8. Recent events

Apparently, the DPG had been surprised by the intensity of the reactions. They had believed that they could easily eliminate the KPC once and forever. Since it was not so easy, they started a campaign in order to bring the various groups “to the party line”. Meetings took place in various cities. The result was always the same: None of the two sides moved one iota.

In the meantime, many people had heard and discussed about the KPC, people, who had not known anything about the KPC before.

A great number of DPG members considered the lapse of the DPG harmful for the reputation of the society. They wanted the report to be withdrawn. In particular, a group of 21 theoretical physicists of high reputation, several of them award winners, wrote a manifest, asking the DPG to withdraw the report:

“Declaration:

The signatories declare that they do not agree with the criticism formulated in the report and in the supplement. They consider the examples, that are to prove that the KPC contains “experimentally detectable false statements” unfounded. Therefore, they dissociate from the recommendation of the DPG Executive Board given in the name of the DPG members. They ask the DPG Board to withdraw the recommendation with immediate effect.”

But also this initiative had no effect. Since there was no easing of the tension, the DPG invited the theoretical physicists group to a discussion meeting. It took place on January 10 in a conference room at Frankfurt Airport.

However, also at this meeting both parties repeated the statements, opinions and claims that they had already published previously. It was obvious that for the DPG there was no turning back.

Finally, this March 17, the KPC was on the agenda at a DPG general assembly. There, the report was submitted to a formal vote. There was a great majority in favour of the DPG activities. Apparently, the majority of the participants of the meeting did not know the KPC. The president of the DPG argued that an expert commission had found substantial errors in the course. It is natural, that the vote was in favour of the DPG board.

Thereafter, the controversy slowed down. The DPG opponents were tired and frustrated. The DPG had not

really attained its goal. They had started a year before with the conviction to be able to erase or extinguish any manifestation of KPC related ideas. Instead, their activity became a publicity campaign for the KPC, which we would never have been able to realize ourselves. KPC related physics is discussed more than ever in seminars and teacher training courses.

Finally we were informed by our publisher in Shanghai that the KPC was, with a delay of one year, approved as a schoolbook in China.

References

- [1] http://www.physikdidaktik.uni-karlsruhe.de/publication/pub_fremdsprachen/englisch.html
- [2] Herrmann, F. (2006). Der Karlsruher Physikkurs, Ein Lehrbuch für den Unterricht in der Sekundarsufe I, AULIS Verlag Deubner, Köln
- [3] <http://www.physikdidaktik.uni-karlsruhe.de/publication/index.html>
- [4] Falk, G., Herrmann, F. and Schmid, G. B. (1983). Energy forms or energy carriers?, Am. J. Phys. **51**, p. 1074-1077
- [5] Herrmann, F. and Schmid, G. B. (1984). Statics in the momentum current picture, Am. J. Phys. **52**, p. 146-152
- [6] Schmid, G. B. (1984). An up-to-date approach to physics, Am. J. Phys. **52**, p. 794-799
- [7] Herrmann, F. and Schmid, G. B. (1985). Momentum flow in the electromagnetic field, Am. J. Phys. **53**, p. 415-420
- [8] Herrmann, F. (1989). Energy density and stress: A new approach to teaching electromagnetism, Am. J. Phys. **57**, p. 707-714
- [9] Herrmann, F. (1991). Teaching the magnetostatic field: Problems to avoid, Am. J. Phys. **59**, p. 447-452
- [10] Falk, G. (1985). Entropy, a resurrection of caloric—a look at the history of thermodynamics, Eur. J. Phys. **6**, p. 108-115
- [11] Herrmann, F. and Schmid, G. B. (1985). Analogy between mechanics and electricity, Eur. J. Phys. **6**, p. 16-21
- [12] Herrmann, F. and Schmid, G. B. (1986). An analogy between information and energy, Eur. J. Phys. **7**, p. 174-176
- [13] Heiduck, G., Herrmann, F. and Schmid, G. B. (1987). Momentum flow in the gravitational field, Eur. J. Phys. **8**, p. 41-43
- [14] Herrmann, F. and Job, G. (1996). The historical burden on scientific knowledge, Eur. J. Phys. **17**, p. 159-163
- [15] Herrmann, F. (2000). The Karlsruhe Physics Course, Eur. J. Phys. **21**, p. 49-58
- [16] Job, G. and Herrmann, F. (2006). Chemical potential – a quantity in search of recognition, Eur. J. Phys. **27**, p. 253-371
- [17] <http://www.logos-verlag.de/cgi-bin/buch/isbn/823>
- [18] http://www.mnu.de/images/Dokumente/PDF/concepta-alt/mnu_publ_KPC_mnu_1998.pdf
- [19] http://www.dpg-physik.de/veroeffentlichung/stellungnahmen_gutachter/index.html
- [20] Planck, M (1908). Bemerkungen zum Prinzip der Aktion und Reaktion in der allgemeinen Dynamik, *Physikalische Zeitschrift*, 9. Jahrgang, **23**, 828
- [21] Landau, L. D. and Lifshitz, E. M. (1959). Theory of Elasticity, Chapter 1, Section 2, Pergamon press, Oxford
- [22] Landau, L. D., Lifshitz, E. M. (1962). The Classical Theory of Fields, Chapter 4, p. 91, Pergamon press, Oxford
- [23] Callendar, H. L. (1911). The caloric theory of heat and Carnot's principle, Proc. Phys. Soc. London **23**, p. 153
- [24] Maxwell, J. C. (1873). A treatise on Electricity and Magnetism, Volume 2, p. 7
- [25] Sommerfeld, A (1964).: Elektrodynamik, Akademische Verlagsgesellschaft, Leipzig, p. 39 and p. 78
- [26] http://www.physikdidaktik.uni-karlsruhe.de/KPC/Fragen_Kritik/DPG.html

Affiliation and address information

Friedrich Herrmann and Michael Pohlig
Karlsruhe Institute of Technology
Faculty of Physics
Wolfgang-Gaede-Straße 1
76131 Karlsruhe
Germany
e-mail: f.herrmann@kit.edu

ThermoLab – Simulating Thermal Processes by Simulating Gibbs Ensembles

Oliver Frisius, Friedrich Herrmann, Michael Pohlig
Karlsruhe Institute of Technology, Karlsruhe, Germany

Abstract

ThermoLab is a software that simulates thermodynamic processes. Its purpose is to help getting an intuitive feeling for the physical quantities entropy, temperature and chemical potential from a statistical point of view. Its distinctive feature is that a physical system is represented by a Gibbs ensemble. The software gives the user an insight into the working of statistical physics without the necessity to follow involved mathematical derivations. One gets insights into the similarity and the difference of the roles of the two intensive quantities temperature and chemical potential in statistical physics. One also learns about entropy: It is a quantity of a more general scope than temperature and chemical potential.

Keywords

Statistical thermodynamics, simulation, Gibbs ensemble, entropy, chemical potential

1. Introduction

ThermoLab is a software, that was developed in 1998 in a Master thesis work by one of us (O. F.). It is one of several other programs that have been developed by our group, and it can be downloaded from

<http://www.physikdidaktik.uni-karlsruhe.de/software/index.html>

There are several ways to simulate thermodynamic systems. One can a system with a great number of particles and calculate values of temperature, entropy and so on by averaging over the particles. The restriction is that one needs a many-particle system. We chose a second possibility. We simulate a statistical ensemble. That means that the computer simulates a great number of copies of a physical system, the microsystems.

We shall first give an overview of the software. After that we shall discuss an examples of an application of the software.

2. Simulating a statistical ensemble

When using the software, one has several choices. We will go through the most important of them. First one has to choose the nature of the system: How many particles sit in how many locations (which may be atoms or crystal lattice defects)? How many excited state do exist?

Next one has to prepare the initial state of the ensemble: The ensemble consists in say 1000 copies of the chosen system. Choosing the initial state means, that one tells the software, in which microstates all these microsystems are. There are mainly two possibilities.

- One defines the microstates by entering a temperature. That means that the system that is represented by the ensemble is in thermodynamic equilibrium. Thereby the software puts the microsystems statistically into microstates in such a way that a Boltzmann distribution results.
- An arbitrary energy distribution can be defined manually.

Finally one has to choose the variables that are to be represented in a diagram, typically entropy, temperature, particle number and chemical potential as functions of time.

Next the simulation is started. It runs step by step. In each step, energy is statistically exchanged between the particles in each micro-system. These changes are done independently for each of the various (many) microsystems. In addition to an energy exchange one can also allow for an exchange of particles.

For each instant of time (time step) the values of the macroscopic quantities are calculated, i.e. the quantities

that refer to the whole ensemble. Their values are plotted over time.

If the initial state was not a state of thermodynamic equilibrium, then the macro-system will run by itself into such a state, whereby the entropy increases. Notice, that the system or the ensemble, has a well-defined entropy in any state – not only in equilibrium states. This is in contrast to temperature and chemical potential, which are good variables only in states of thermodynamic equilibrium.

In addition, for each time step the energy distribution of the states is compared with a theoretical distribution. As long as the system is not in equilibrium, the match between its energy distribution and the theoretical distribution is still bad. In this case temperature is not a well-defined quantity. However, the program calculates a “best value” for it, and it tells us how far we are away from a well-defined temperature. So we can see, how a temperature “emerges”, as the system is approaching equilibrium. The same holds for the chemical potential.

An important feature of the software is that several macro-systems can be simulated simultaneously. These systems can then be coupled together. This coupling can be done in two different ways: thermally, which means that we allow for an exchange of entropy, or chemically, where we allow for an exchange of particles. Doing so it can be seen that the temperatures of two subsystems that are thermally coupled approach each other whereby the total entropy increases. We also see that entropy is produced. If then the particle exchange is switched on, the chemical potentials will also adjust each other whereby again entropy is produced.

The software gives the user an insight into the working of statistical physics without the necessity to follow the involved mathematical derivations. One gets an intuitive feeling about the similarity and the difference of the roles of the two intensive quantities temperature and chemical potential in statistical physics. One also learns about entropy: It is a quantity of a more general scope than temperature and chemical potential.

3. Example

We want to know what happens, when two systems S1 and S2 are brought first in thermal contact (entropy exchange) and then in “chemical contact” (particle exchange).

S1 consists of four particles that are distributed over five “positions”. (One may imagine the particles to be electrons and the positions neighbouring lattice defects in a solid that can either be empty or occupied by one electron.) Each particle can be in the ground state or in one of three equidistant excited states.

S2 consists of two particles that again can occupy 5 positions.

Each of the systems S1 and S2 is represented by 1000 microsystems.

We prepare S1 by choosing a high temperature T_1 , and S2 by choosing a lower temperature T_2 . The software calculates the chemical potentials μ_1 and μ_2 of both systems.

Fig. 1 shows a window where the microstates of S1 are displayed. By scrolling, all of the microstates can be seen. Another window shows the microstates of S2.

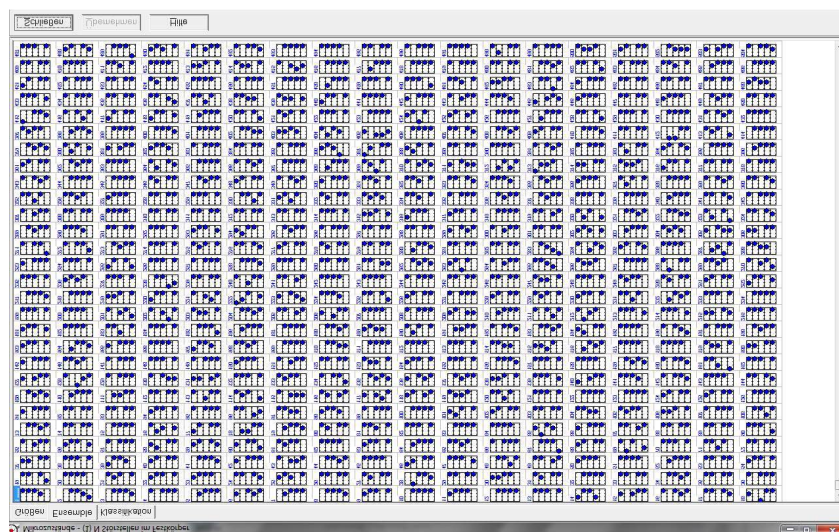

Figure 1. Microstates of system S1

We now open several windows for the graphical representations of the various variables as a function of time:

- the entropies of S1 and of S2, Fig. 2
- the sum of these entropies, Fig. 3
- the temperatures of S1 and of S2, Fig. 4
- the chemical potentials of S1 and of S2, Fig. 5.

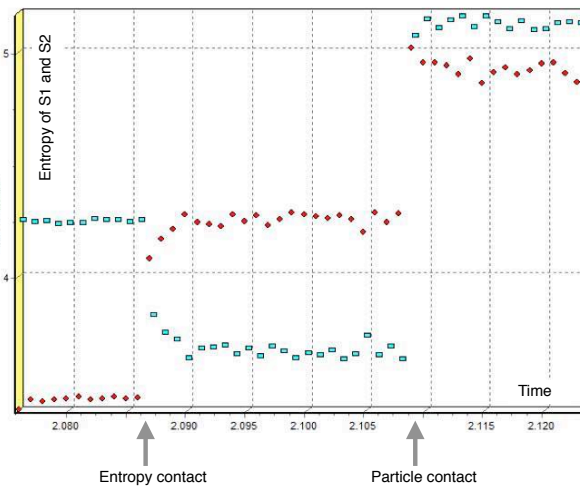

Figure 2. Entropy of S1 (squares) and of S2 (diamonds). When the thermal contact is switched on, the entropy of S1 decreases, that of S2 increases

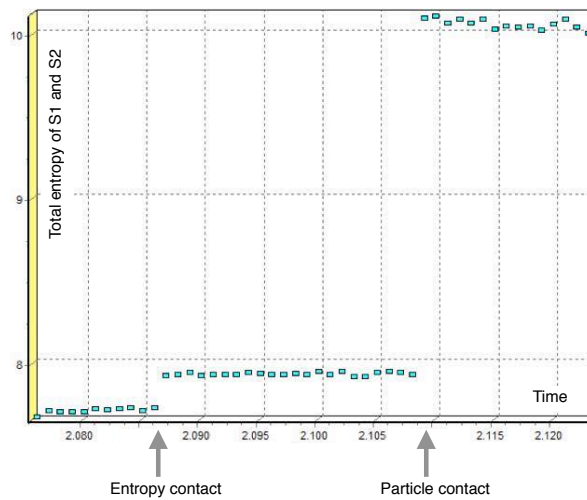

Figure 3. Total entropy of systems S1 and S2. The entropy increases when thermal contact is switched on, and again when particle exchange is switched on.

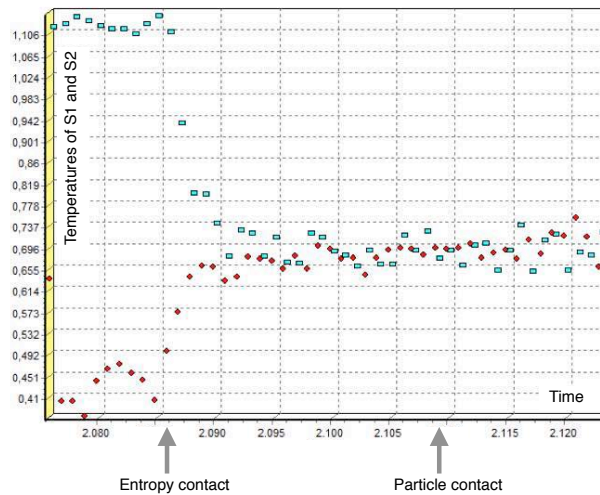

Figure 4. Temperatures of S1 (squares) and S2 (diamonds). As the thermal contact is switched on, temperatures become equal.

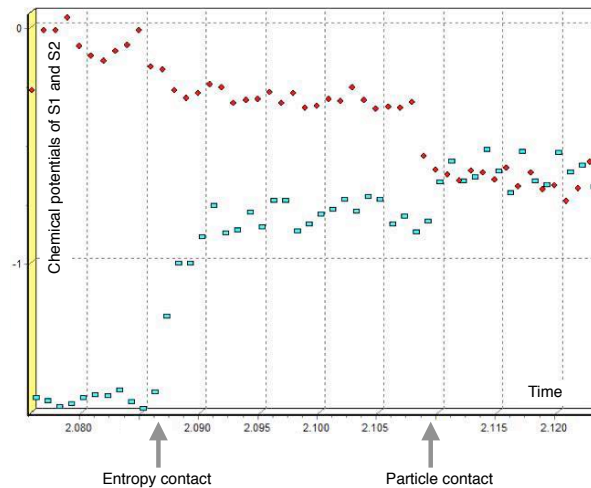

Figure 5. Chemical potentials of S1 (squares) and S2 (diamonds).. As particle exchange is switched on, the chemical potentials become equal.

Upon starting the simulation, the energy is redistributed statistically within each of the microsystems of S1 and of S2. Since both systems S1 and S2 are prepared with a well-defined temperature, i.e. in a state of thermodynamic equilibrium, nothing happens: apart from fluctuations all the variables that are displayed in Fig. 2 to 5 remain constant.

We then switch on a thermal contact between S1 and S2. Several things happen:

- The entropy of the hotter system S1 decreases.
- The entropy of the cooler system S2 increases.

The reason is that entropy is flowing from S1 to S2 until both temperatures have become equal.

- The total entropy increases.

The reason is that the process of entropy transfer is irreversible; new entropy is produced.

- The temperatures approach each other until both are equal.

S1 and S2 are now in thermal equilibrium.

- Both chemical potentials change their values.

The reason is that the chemical potential depends on temperature.

Next, we also switch on the particle exchange. Again all the variables change their values. This time the final state is not only a state of thermal equilibrium, but also of chemical equilibrium, which is shown by the fact that now also the chemical potentials have equalled. Notice, that again entropy is produced as the chemical equilibrium is establishing.

Affiliation and address information

Friedrich Herrmann, Michael Pohlig
Karlsruhe Institute of Technology
Faculty of Physics
Wolfgang-Gaede-Straße 1
76131 Karlsruhe
Germany
e-mail: f.herrmann@kit.edu

How Secondary School Students Conceptualize Infrared Radiation – Matter Interaction? Findings from a Research Study and Implications for an Instructional Design

María Isabel Hernández, Raquel Ríos, Roser Pintó

Centre for Research in Science and Mathematics Education, Universitat Autònoma de Barcelona, Spain

Abstract

This study has been carried out within the REVIR scenario, which is a project promoting that secondary school students have access to a computerized laboratory at the Faculty of Education of our university and work in small groups during four hours with specific instructional material. One of the laboratory sessions included in the REVIR project deals with IR radiation - matter interaction, and is addressed to post-compulsory secondary students (16 - 18 year-old students). Within this framework, we have conducted a research study to analyse students' conceptualizations of the processes or mechanisms that take place in IR radiation - matter interaction (energy transfer, selective absorption), and its effects at a macroscopic level (temperature increase) and at a molecular level (vibration). For data collection, a question was posed to all students at the end of each REVIR session, asking students to relate what was described in an article about the application of an IR laser for acne treatment to what they had learnt throughout the session. The analysis of the 67 students' answers to that question revealed that many students explained the effects of the IR laser in vague terms, often repeating information included in the article, without explaining absorption of IR radiation in terms of energy. In consecutive versions of the instructional material, more oriented application questions were added after the article and explicit discussion around synthesis and exploratory (of students' previous ideas) questions was carried out during the session. From the analysis of 49 and 119 students' answers in consecutive later versions, we found that the introduction of these changes resulted in a greater number of students' descriptions in macroscopic and microscopic terms, and a lower number of answers simply repeating information extracted from the reading. Furthermore, more students explicitly explained absorption in terms of energy associated to IR light. Implications for the instructional design, in terms of critical features affecting people's abilities to transfer what they have learned, are discussed below.

Keywords

Upper secondary education, laboratory activities, students' conceptions, absorption, infrared radiation – matter interaction, knowledge transfer, instructional design

1. Introduction

The research context: The REVIR scenario

This study has been carried out within a singular context, the REVIR (Reality – Virtuality) scenario. REVIR is a project giving access to secondary school students (12-18 years old) to a computerized laboratory at the Faculty of Education of our university. In each REVIR session, students work for four hours, most of the time in small groups (2-5 students), but they are also involved in whole group discussions. In each REVIR session, students use computers connected to an interactive whiteboard, but they also use other ICTs for collecting and analysing data, for visualization, etc. (data-logging systems, simulations, specific software, etc.), depending on the contents and experiments they perform.

In each REVIR session more than one teacher assistant is usually supporting and orienting students. Several REVIR sessions about different science topics are offered to schools at present, and they all include content from the official Catalan science syllabus. In each session, students are provided specific instructional materials in the form of digital worksheets describing the sequence of tasks to carry out and the questions to answer. The instructional materials for each session have been designed taking into account science education research findings (i.e. students' preconceptions and main difficulties on certain science topics, effective science teaching strategies, etc). Furthermore, these teaching and learning materials are iteratively

developed evaluating its effectiveness (i.e. the extent that the learning experiences and outcomes from the intervention are consistent with the intended learning objectives) and taking into account students' difficulties carrying out the tasks or answering the questions.

A REVIR session on IR radiation – matter interaction

One of the laboratory sessions included in the REVIR project deals with EM radiation - matter interaction, and is addressed to post-compulsory secondary school students (16 - 18 years-old). This topic has been recently included in the official science syllabus in Catalonia. Most teachers manifested a concern for how to deal with this topic in an experimental way. To attend this need, two of the authors designed a new instructional material to be offered as a new REVIR session. Its main aim is to make students understand the effects of infrared (IR) radiation – matter interaction, and the underlying processes, at a macroscopic and at a molecular level. The structure of this instructional design is described below:

Presentation of the challenge and questioning

As all REVIR sessions, this one also starts by posing a question or problem to be solved by the students. It is contextualised around an inspection that has been carried out in a company that stores gases such as methane, hydrogen and argon and has detected a leak of a greenhouse gas (GHG). Then, the challenge presented to students consists of answering 'How could they predict and determine which gas is a GHG?', and 'How could they explain its behaviour?'

Experimental design and data analysis

Once students have elicited their previous ideas about the greenhouse effect and GHGs, they are asked to design an experiment to analyse the macroscopic effects (temperature increase) of IR radiation – matter interaction on the gases' behaviour. The main purpose is to promote students' discussion on the variables affecting the experimental results and on how to control them. Once they have discussed the experimental setup, a whole class discussion ends up in an agreement to carry out an experiment consisting of preparing two systems simulating two atmospheres with different degree of CO₂ concentration: System 1 containing just water (apart from air); System 2 containing hydrochloric acid (apart from air) and adding sodium bicarbonate. In System 2, a chemical reaction is produced and, as a result, CO₂ is created, which increases the concentration of this gas in this system (Figure 1). Each system is exposed to IR radiation keeping the same distance from the IR lamp.



Figure 1. Experimental setup

Before carrying out the experiment, students make predictions about the evolution of the temperature in each system. Later, they use data-logging systems (temperature sensor) to collect data in a graphical form (Figure 2) during the experiment and to analyse the results. Finally, students are asked to draw conclusions about the macroscopic effect provoked by a higher concentration of CO₂ as a GHG¹.

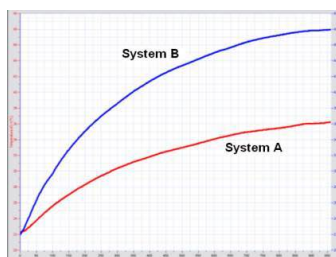

Figure 2. Graphical representation of the experimental result (temperature vs. time)

¹ The discussion of students' experimental results does not take into account the role played by water vapour in the increase of temperature as a GHG since, at this point, most students do not recognise this gas as a GHG yet. This point is discussed later during the activity sequence.

In a later version of the instructional material, an additional exploratory question was posed and discussed with the whole group at the end of this section, asking students to explain how they think GHGs' temperature increase when interacting with IR radiation.

Visualisation at a molecular level

Students interact with a simulation² in order to explore the effects of different types of radiation (microwave, infrared, visible, ultraviolet) on molecules present in the atmosphere (carbon monoxide, nitrogen, oxygen, carbon dioxide, water, nitrogen dioxide, ozone). From this simulation, students have to infer the common behaviour of the molecules that interact with IR radiation (molecular vibration as a different effect from molecular rotation, electronic excitation or molecular bond breaking). Then, students are asked to relate the macroscopic behaviour (temperature increase) empirically observed in the previous section to the molecular behaviour (molecular vibration). In a later version of the instructional material, additional exploratory questions were posed and discussed with the whole group, asking students to invent an explanation of why molecules vibrate when IR radiation is emitted.

Discussion of a scientific interpretation

At this point, a scientific interpretation for this macroscopic and molecular behaviour is briefly discussed within the whole group of students. IR radiation is characterised by certain wavelengths and frequencies and also by a certain amount of energy that can be transferred. Different modes of molecular vibration are then associated to the internal energy of the GHGs, which is increased as a result of the absorption of part of the energy emitted by an IR lamp.

Application of the scientific interpretation in IR spectroscopy

Students are introduced to an IR spectrophotometer by means of a video and explore theoretical IR absorption spectra, using a molecule viewer³. Substances are considered transparent to a certain type of radiation if part of the incoming energy is transmitted through it without producing effects. Students are expected to identify which gases can be considered GHGs depending on whether they present an absorption peak / band for certain IR frequencies in their IR spectra (Figure 3).

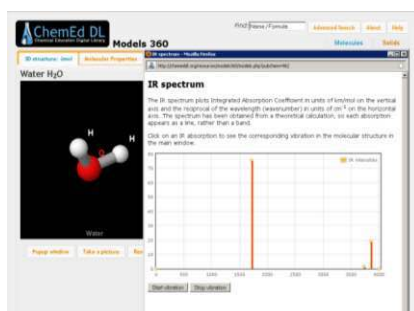

Figure 3. Theoretical IR spectrum of water molecules

Solution of the initial challenge and application of knowledge to new questions

At the end of the session, students are asked again how to predict and determine which gas is a GHG. After discussing their answers with the whole group, students are asked to individually read an article⁴ from a science magazine on a laser emitting IR radiation that is applied in acne treatments. This “IR laser” article explains that “the laser emits IR radiation with a specific frequency that fat can absorb more efficiently than water, and thus fat is heated and can be melted and destructed”. From the reading of the “IR laser” article, students were asked to relate what is explained in this article to what they have learnt during this session.

2. Theoretical framework

Regarding radiation – matter interaction, various authors have analysed students' understanding of greenhouse effect and global warming (Besson et al 2010, Ekborg & Areskoug 2006, Koulaïdis & Christidou 1999, Rye et al 1997, Shepardson et al 2011). According to these authors, common students' mental models or conceptions of EM radiation-matter interaction explain *enhanced* greenhouse effect in terms of:

- Atmosphere gases ‘trapping’ all incoming solar radiation, but not Earth’s radiation.

² <https://phet.colorado.edu/en/simulation/molecules-and-light>

³ <http://www.chemeddl.org/resources/models360/models.php>

⁴ <http://www.muyinteresante.es/salud/articulo/desarrollan-un-laser-para-acabar-con-el-acne>

- Solar radiation heating but not getting out from the Earth because solar radiation weakens.
- The ozone layer depletion or the ‘ozone hole’, provoking an increase of incoming UV rays, which warm up the Earth’s surface.
- The energy released from cars’ engines, instead of the CO₂ released.
- Specific gases released from human activities (e.g. CO₂, CH₄, CFCs but not H₂O vapour).

Not so many research studies have focused on teaching and learning phenomena involving EM radiation – solid matter interactions (Redfors & Ryder 2001, Viennot & Décamp 2014). According to these authors, students tend to explain the effects of EM radiation – matter interaction on metals at different levels:

- Macroscopic level: In terms of processes taking place (e.g. reflection, absorption).
- Mesoscopic level: In terms of bodies’ surface properties (e.g. “emissivity” or “reflectivity” of a body).
- Microscopic level: In terms of unbound electrons (free to move), excitation of atoms or molecules when colliding with photons, or atoms not providing photons room to pass.

For this research study, apart from considering previous research findings on students’ conceptions of related phenomena, we have also considered literature reporting critical features of learning that affect people’s abilities to transfer what they have learned (Bransford et al. 2004). In this sense, we have taken into account some of the following critical features of the instructional design in order to justify the types of changes made to consecutive versions of the designed instructional material to facilitate students’ knowledge transfer from one context (GHGs) to another (IR laser):

- Amount and kind of initial learning: Focus on exploration or elicitation of students’ previous conceptions.
- Students’ motivation towards the topic or tasks.
- Time on task.
- Frequent feedback to support students’ conceptual development, discussing students’ interpretations during group discussions and asking explicit questions.
- Variety of contexts used.
- Metacognitive approach.

3. Research questions

From the previous description of the activity sequence and the theoretical framework already discussed, we focused on students’ development and use of explanatory models of the physical processes involved in specific socioscientific issues such as global warming and techno-scientific developments. With the purpose to understand the effectiveness of this designed instructional material, we conducted the research study presented here, which is intended to answer the following research questions:

RQ1. How do students conceptualise the processes (or mechanisms) that take place in IR radiation – matter interaction, and its effects at a macroscopic level and at a molecular level?

RQ2. How do these students’ conceptualizations evolve in consecutive versions of the instructional design and interventions?

4. Data collection and data analysis

Qualitative data were collected at the end of several REVIR sessions on the topic of IR radiation – matter interaction, via students’ written responses to individual application open questions after reading the “IR laser” article described in section 6 of the activity sequence. Students’ written productions in this task were conceived as the expression of their conceptions, which allow inferring qualities of their understanding.

We can distinguish three different stages of data collection:

- Academic year 2012-13 (S1): n = 67 students from 3 different schools. These students participated in the implementation of the first version of the instructional material. From the reading of the “IR laser” article, students were asked to *relate what is explained in this article to what they have learnt during this session*.
- First term of academic year 2013-14 (S2): n = 49 students from 2 different schools. These students participated in the implementation of the first version of the instructional material but from the reading

of the “IR laser” article, they had to answer a more oriented application question: *How would you explain what happens to fat when it absorbs IR radiation emitted by the laser?*

- Second term of academic year 2013-14 (S3): n = 119 students from 5 different schools. These students participated in the implementation of the second version of the instructional material, which included further group discussion around specific exploratory and synthesis questions, and answered the second version of the application question from the reading of the “IR laser” article.

The collected data were analysed in an inductive manner to identify concepts and patterns on how students conceptualize IR radiation – matter interaction in students’ responses. Inductive analysis as a qualitative methodology involves immersion into the details of the data in order to identify important categories, as opposed to imposing pre-existing expectations on the data. However, taking into account previous dimensions identified in the abovementioned literature, we classified emerging categories around three dimensions:

- Description of the effects of IR radiation - matter at a macroscopic level (DMA)
- Description of the effects of IR radiation - matter at a microscopic level (DMI)
- Explanation of the processes or mechanisms involved in IR radiation – matter interaction (EXP)

5. Results

From the analysis of the collected data in each stage (i.e. students’ answers to the individual application question posed at the end of each REVIR session from the reading of the “IR laser” article), we could define certain categories of students’ responses of how they conceptualise IR radiation – matter interaction. Table 1 shows the relevant categories that emerged from the data analysis for each pre-established dimension as we constructed meaning from students’ responses. Table 1 also shows examples of students’ quotes to illustrate each category and the number of students’ responses in each category.

Table 1. Emerging categories, students’ quotes, and number of students’ responses

Dimension	Categories	Students’ quotes	S1	S2	S3
DMA (Description in terms of...)	... physical changes already mentioned in the “IR laser” article (e.g. temperature increase, fat melting) – DMA1	<i>“The contact between IR radiation and the skin heats the fat up and it melts”</i>	32/67	41/49	93/119
	... other changes not mentioned in the “IR laser” article (e.g. fat burning, composition change) – DMA2	<i>“Fat decomposes in simpler organic molecules”</i>	6/67	7/49	7/119
	Students do not describe effects at a macroscopic level	-	30/67	12/49	19/119
DMI (Description in terms of...)	... vibration of atoms / molecules – DMI1	<i>“Fat molecules start vibrating”</i>	4/67	13/49	44/119
	... weakening of molecular bonds – DMI2	<i>“If the molecules vibration is very high, molecules separate, their bonds break”</i>	1/67	3/49	37/119
	... changes to the modes of vibration of atoms / molecules – DMI3	<i>“Fat bonds can strain or bend”</i>	0/67	6/49	9/119
	Students do not describe effects at a microscopic level	-	62/67	27/49	43/119

level	
EXP (Explanation in terms of...)	... absorption of radiation, already mentioned in the “IR laser” article – EXP1 <i>“There are molecules that can absorb IR radiation”</i> 5/67 4/49 0/119
	... absorption of certain radiation (λ / f), already mentioned in the “IR laser” article – EXP2 <i>“Fat produced by sebaceous glands can absorb the wavelength of the laser and so it gets burnt”</i> 42/67 21/49 42/119
	... absorption as a mechanism consisting of hindering the passage of radiation – EXP3 <i>“Fat absorbs laser’s light, not letting it pass to muscular tissues”</i> 13/67 1/49 13/119
	... absorption as a mechanism consisting of a process of energy transfer – EXP4 <i>“The kinetic energy of particles increases and so does fat’s temperature”</i> 2/67 6/49 28/119
	... absorption as a mechanism consisting of radiation detecting fat – EXP5 <i>“IR radiation enters into the skin and locates the fat”</i> 1/67 1/49 2/119
	Students do not explain any underlying mechanism - 16/67 20/49 48/119

Figure 4 summarises the percentage of students (from each stage of data collection) in each dimension whereas Figure 5 represents the percentage of students (from each stage of data collection) in each category.

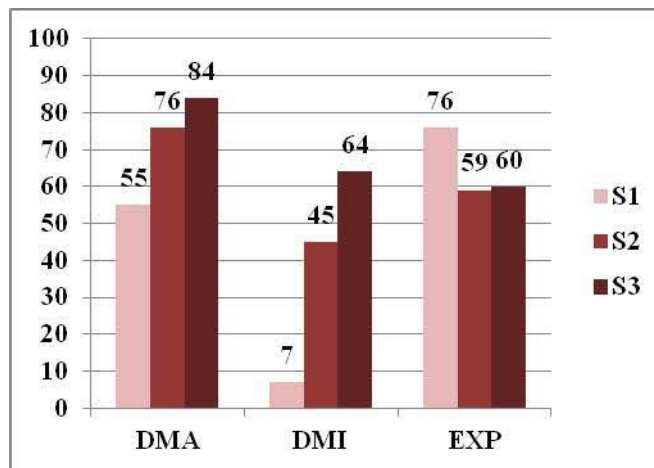

Figure 4. % of students’ responses (from each stage of data collection) in each dimension

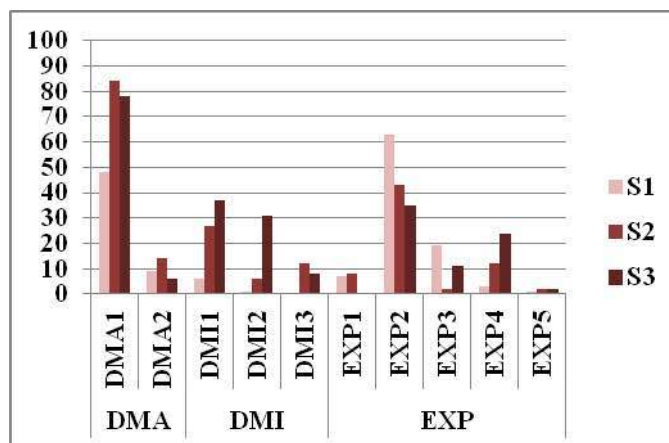

Figure 5. % of students' responses (from each stage of data collection) in each category

Considering the results from S1, we evidenced that students tended to relate what they read in the “IR laser” article to what they had learnt during the session mainly highlighting the information from the article which had been explicitly discussed in class (e.g. temperature increase, selective absorption). Thus, most of students (55%) described the effects of IR radiation – matter interaction at a macroscopic level (DMA), mainly in terms of temperature increase and/or fat melting (DMA1), whereas very few students (7%) were able to describe the effects at a microscopic level (DMI). Similarly, although a high number of students (76%) were able to highlight some mechanism underlying IR radiation – matter interaction (EXP), most of them just mentioned the selective absorption of radiation as the main process involved (EXP2). Therefore, most students just repeated the information provided in the “IR laser” article, without establishing connections with concepts (e.g. changes to the modes of molecular vibration associated to the internal energy of the substances, absorption of part of the energy emitted by an IR laser) analysed throughout the REVIR session.

As these results were considered quite poor because of the little connection between the application task and the content tackled and discussed during the session, new data were collected in S2 from the new application questions posed after reading the “IR laser” article. The new version of the application questions was more explicit or oriented, trying to promote that students further described effects and explained underlying mechanisms or physical processes involved in IR radiation – matter interaction. Thus, this change to the application question was intended to facilitate students' knowledge transfer from the context used during the instruction (GHGs) to the one used in the application (IR laser for acne treatment). The analysis of these data (S2) provided evidence that a higher number of students (76%) were able to describe the effects of IR radiation – matter interaction at a macroscopic level (DMA), but also a higher number of students (45%) were able to describe the effects at a microscopic level (DMI), mainly in terms of molecular vibration (DMI1). Moreover, although a lower number of students (59%) were able to highlight absorption as an underlying mechanism involved in IR radiation – matter interaction, a slightly higher number of students (12%) were able to explain absorption in terms of energy (EXP4) instead of just in terms of radiation (EXP1 / EXP2).

In spite of a remarkable decrease from S1 to S2 in the number of students' answers just repeating pieces of information from the “IR laser” article, we also identified certain students' difficulties in describing the effect of IR radiation – matter interaction at a microscopic level (DMI) and in explaining underlying mechanisms (EXP). For instance, many students from S2 expressed that molecular vibration is the effect of the absorption of IR radiation, as if molecules did not vibrate without any interaction with IR radiation. Another example is that very few students were able to explain absorption in terms of energy (EXP4) although section 4 from the activity sequence was explicitly devoted to discuss this scientific interpretation. Taking into account the previous results, further exploratory and synthesis questions were included and discussed with the whole group in a later version of the activity sequence, as described above. The results of the analysis of data from S3 provided evidence that not only a higher number of students (84%) were able to describe the effects of IR radiation – matter interaction at a macroscopic level (DMA), but also a higher number of students (64%) were able to describe them at a microscopic level (DMI). Moreover, a higher number of students (24%) were able to explain absorption in terms of energy (EXP4) instead of in terms of radiation (EXP1 / EXP2).

6. Conclusions

From this research study, we have been able to analyse students' conceptualizations of the processes or mechanisms that take place in matter - IR radiation interaction, and its effects at a macroscopic level and at a molecular level (RQ1). The analysis of students' answers from S1 provided evidence that many students were able to conceptualize the effects resulting from IR radiation – matter interaction in macroscopic terms (temperature increase), but not so many students were able to describe these effects in microscopic terms (molecular vibration). We might interpret this result in terms of students' difficulties to relate the effects at a macro and micro level, but it might be also interpreted in terms of the type of application used (too general) or in terms of aspects of the instructional design and intervention. We also evidenced that most students identify selective absorption of radiation as the main mechanism involved in IR radiation – matter interaction, which is relevant. However, very few students were able to transfer their knowledge from one context to the other about energy transfer in explaining the mechanisms underlying IR radiation – matter interaction.

With regards to RQ2, we have evidenced that the introduction of more oriented application questions and the discussion with the whole group on exploratory and synthesis questions during the instruction resulted in a greater number of students' descriptions in macroscopic and microscopic terms, a lower number of information explicitly repeated from the "IR laser" article, and a slightly higher number of explanations in terms of energy.

Acknowledgements

This work was funded by 'La Caixa' Foundation, which supports the REVIR project. Moreover, the research was supported by the Ministry of Science and Innovation (MICINN) under the EDISTE project (EDU2011-28431).

References

- Besson, U., De Ambrosis, A. and Mascheretti, P. (2010). Studying the physical basis of global warming: thermal effects of the interaction between radiation and matter and greenhouse effect, *European journal of Physics*. **31**, 375-388.
- Bransford, J. D., Brown, A. L. and Cocking, R. R. (2004). Learning and Transfer. In: *How People Learn: Brain, Mind, Experience, and School*, National Academy Press, Washington D.C.
- Ekborg, M. and Areskoug, M. (2006). How student teachers' understanding of the greenhouse effect develops during a teacher education programme, *NorDiNa*. **5**, 17-29.
- Koulaidis, V. and Christidou, V. (1999). Models of Students' Thinking Concerning the Greenhouse Effect and Teaching Implications, *Science Education*. **83** (5), 559-576.
- Redfors, A. and Ryder, J. (2001). University physics students' use of models in explanations of phenomena involving interaction between metals and electromagnetic radiation, *IJSE*. **23** (12), 1283-1301.
- Rye, J. A., Rubba, P. A. and Wiesenmayer, R. L. (1997). An investigation of middle school students' alternative conceptions of global warming, *IJSE*. **19** (5), 527-551.
- Shepardson, D.P., Choi, S., Niyogi, D. and Charusombat, U. (2011). Seventh grade students' mental models of the greenhouse effect, *Environmental Education Research*. **17** (1), 1-17.
- Viennot, L. and Décamp, N. (2014). Which side to put the survival blanket? Analysis and suggestions for activities with students. Published by the MUSE group (More Understanding with Simple Experiments) in the Physics Education Division (PED) of the European Physical Society (EPS).

Affiliation and address information

María Isabel Hernández Rodríguez
 CRECIM (Centre for Research in Science and Mathematics Education)
 University Autonomous of Barcelona
 Campus de Bellaterra, Facultat de Ciències de l'Educació, GL-304
 08193 Cerdanyola del Vallès, Barcelona
 Spain
 e-mail: mariaisabel.hernandez@uab.cat

Is it Difficult to Motivate our Students to Study Physics?

Renata Holubova

Palacky University, Olomouc, CZ

Abstract

The main issue of this paper is the discussion around the question „how can we teach and motivate the why-generation learners?“. The why - generation, called also Y gen, Millennial generation, was born in 1980-2000. The generation Y students learn and study in such a different way as the previous gen X did. They have other characteristics than generation X that are important and affect their learning in positive and negative ways. Gen Y students are characterized as www users and technology users. Gen Y is powerful and able to change the world. They want to learn with technology, online and doing thing that matter – this is almost important for them. Being on line is necessary for learning, research, socializing. The aim of our project was to find out teaching and learning methods that teachers and learners can use in 21st century classroom. Strategies how to engage gen Y learners in the learning process should be found. During our research various methods were used: problem based learning, project based learning, team work, inquiry based learning, interdisciplinary approach, experiments – from very simple and low cost experiments to computer based experiments and remote laboratories. It was found out, that generation Y learners can be motivated by various instructional methods based on their own activity. Their own doing seemed to be more important for them than learning itself. It is necessary to use educational materials including charts, graphic presentations and cartoons. It was found out that a very useful tool for our students can be the mind mapping. Mind maps are not common during students' instruction at secondary and high schools in the Czech republic. We prepared a set of mind maps on the basis of high school physics textbooks, from mechanics, molecular physics, via electricity and magnetism to optics, and nuclear physics. In this paper the outcomes of our project will be presented so as some examples of interdisciplinary modules that have been prepared – "real-world" physics modules with everyday life problems that can be integrated into the high school curriculum physics (physics in the kitchen, crime scene investigation, environmental physics), non-traditional experiments, properties of non-Newtonian liquids (experiments with dilatant fluids, oobleck, the suspension of starch, the Weissenberg effect, Barus effect, the Kaye effect), modern physics – nanotechnology (cooperation with the Regional Centre of Advanced Technologies and Materials - a faculty establishment) . The findings of this project are incorporated into the subject „Didactics of Physics“ in the undergraduate physics teacher study programme at the Faculty of Science. The paper is supported by the project OPVK CZ.1.07/2.2.00/28.0182.

Keywords

Millennials, teaching methods, conceptual maps, motivation, interdisciplinary

1. Introduction

The issue of teaching Generation Y has been discussed previously (Holubová 2013). Currently, we speak not only of generation Y, but also the newly emerging generation Z. A few years ago the debate about whether the use of digital technology does not digitize the children themselves has been launched, triggered by the publication of books of Don Tapscott in 1998. For example we can point out his book “Growing Up Digital: The Rise of the Net Generation”. It stated, among other things, that from the generational point of view, children are "ahead" of their parents' right in the use of digital technology, which is the key factor in today's society. Prensky (2001) divides the generation into digital natives and digital immigrants. Digital natives are identified as having “radically different way of thinking, processing information and learning new things.” Compared to them, "digital immigrants have very little understanding of these new skills that the natives have cultivated by years of testing and interaction. These skills are something almost foreign to immigrants who learn slowly, step by step, one by one, individually, and above all, with a straight face.” Prensky therefore is one of the main promoters of leaving the traditional method of individualized learning. Primacy

should play class digitization, linking play with learning, increasing interactivity in the classroom. The results stated below show the inability of schools and teachers to adapt to the way of students' thinking and their way of information processing (see results of Czech pupils' reading literacy in PISA).

Today's elementary and middle schools are becoming better and better equipped with ICT technologies. Some teachers perceive this fact very positively and try to engage digital media into educational process. Nowadays it is also agreed in public that today's schools cannot teach our kids just using chalk and blackboard. But only up to date school equipment and modern technology will not improve the quality of teaching. Use of multimedia is not the only way how to motivate students in the classroom. The technology has the potential to modernize teaching and can provide a support, in particular, to the constructivist approach of acquisition of skills and knowledge. Contribution lies mainly in the fact that modern technology will accelerate and automate some of the activities that are tedious, repetitive. The teacher gets more time for the use of activation methods of teaching. Many teachers involve ICT into teaching just because they know that students enjoy using the computer. Often they are not able to exploit the potential that digital technologies have given to teaching. As states Zounek (2009) the issue is a didactic effectiveness: the children are happy when they can be at their computer, but the teacher, because of "packed curriculum", cannot afford it too often. Taking into consideration the huge investment that involves schools technologization, such perception of ICT as a teaching brake seems somewhat paradoxical. It often indicates that teachers are poorly prepared to use ICT technology for didactic purposes. It therefore stresses the baseline at today's school operation due to the link teacher – student and motivation - students can monitor digital technology, the teacher's skills to operate ICT is something rather different from that to be used it in teaching.

The problem often lies in a small compendium of teachers about how to use ICT in teaching different subjects.

2. Research area

The aim of the research was to analyse teaching Physics provided by different teachers in different schools. Our project was intended as a follow-up research to the activity of the Educational Research Centre in Brno. Between the years 2004 - 2007 this centre carried an extensive research on the second level of elementary schools using video-analysis (Janík 2009). Goals of the monitoring have been, for example: organizational forms of teaching, stages of teaching, teaching materials and media used in education, opportunities of verbal expression offered by the instructions. The survey showed that average 14 minutes of the teaching class (of 45 minutes) were devoted to talking with students, 10 minutes – to presentation of a new material, 4.5 minutes – to independent students' work and 3.75 minutes to work in pairs or groups. Most of the teaching hours were rather focused on teachers. In the teaching hours very little time was devoted to a recap of the curriculum. As to the usage of modern tools and technologies in more than 40 % of teaching classes no medium was used. Most experiments were carried out in the traditional way. In the analysis of verbal expression, it was found out that the average number of teacher's words was 2976, while student's – 616 (Janík 2009).

Our own research was also focused on the study of physics' lessons - the design of the lesson - realized by teachers with different specializations and different lengths of teaching experience. In the framework of our investigation auditions at 10 different elementary schools (including private ones and for students with special ADHD disorder - Attention Deficit Hyperactivity Disorder) in cities with different number of inhabitants were carried out.

During the observation period the following indicators were considered:

- teachers' activity - goal setting (e.g., using active verbs "define", "prove"), timing goals, structure of the lesson, work with students, discipline
- methods
- teaching aids
- the use of ICT
- development of the lesson and environmental conditions.

Findings showed that teaching in those schools is conducted by the traditional way. The goal of the teaching was formulated, in 40 % cases, immediately after the start of the teaching hour and mostly using active verbs. Explanation of the new material was provided by a teacher, the general criteria of correctness and adequacy of verbal expression being held. Teachers were able to ask students factually correct and understandable questions, involving the whole class into the dialogue. Unfortunately, these activating

teaching methods were used in a small part of the lesson. An interesting and intriguing explanation of the material appeared only in 30 % of the lessons. Discipline was maintained by warning (50 % of cases), shouting, slamming textbook, referring to the reduction of classification. All teachers during teaching used various equipment - in two classes - computer with a data projector, in one class - video, mostly classical educational aids, sometimes - non-traditional aids (PET bottles). Interesting was the lesson in the classroom with children with ADHD - these children tend to disturb, to be in the spotlight, talking fast. On the other hand, these children were very active in learning, in case of making a mistake were trying to find other solution, discussed. In the rest of schools we visited the majority of students was passive, unwilling to answer or seek for new solutions. One of the most important conclusions of this research is that in addition to the use of data projector and, in one case, an interactive whiteboard, the method of teaching has not changed. Even in today's school prevails classic lesson structure without the use of ICT that does not conform to the requirements for the education of students' generation Y. The same trend persists in a large number of secondary schools, where only few teachers use the potential of problem and project learning, teamwork, interdisciplinary relations and computer controlled experiments.

3. Output of research

As a help to secondary school teachers a set of conceptual maps, based on our findings, has been developed. These maps were created according to physics textbooks used in secondary schools in the Czech Republic. Due to the Generation Y way of learning the mentioned structuring concepts were developed as a tool to increase the quality of learning. Students can also create conceptual maps in free available programs and take advantage of ICT usage. The conceptual structure can also indicate the current state of students' knowledge and can be kept supplemented and refined. It also allows variable use of conceptual maps in teaching:

- Comprehensive conceptual map - is created by the teacher, includes the basic concepts and relationships between them
- Teaching tool - a graphical interpretation of the curriculum, it is possible to use only a part of the map relating to the appropriate section of the curriculum
- Learning aid - students create their own maps.

The map can include concepts from everyday life and other natural sciences. The map is not correct or incorrect, it indicates the current state of student' knowledge and understanding of the concepts discussed. Concept maps, which should serve as a diagnostic tool, can be evaluated by a teacher using the following criteria: complexity, inclusion of basic concepts, and existence of meaningful relationships between concepts.

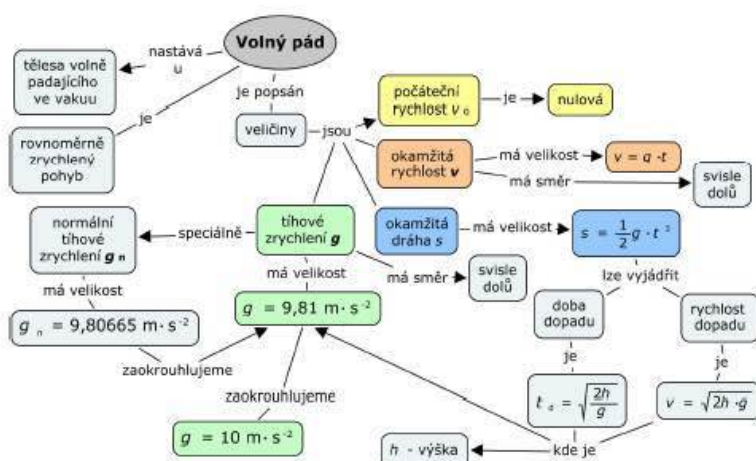

Figure 1. The concept map – free fall

During the course Didactic of Physics students – future teachers of physics are getting familiar with this tool and learn how to create and evaluate conceptual maps. Creating concept maps allow the use of ICT. Software

that was used - CmapTools, SMARTIdeas software 5.1, mind maple, free mind. A set of conceptual maps can be found in <https://app.box.com/shared/2chdt7do43unqme1y665>.

3.1 Upgrading existing modules

As stated in the paper at the conference GIREP 2013 (Holubova 2013), to help our teachers (so as to motivate students) modules that use inter-disciplinary links were prepared. The application of natural sciences in everyday life and also the use of modern technology are underlined to. Primary and secondary schools expressed strong interest, in particular, to the presentation of the modules Physics and Criminology, Culinary Physics and Environmental Physics. Modules have been presented at more than 50 schools in the country. Modules content has been upgraded - it was extended by using of modern technology - thermal imagers and digital microscope, including proposals for series of experiments with these tools.

3.2 Examples of new topics

Thermal imager - link to the teaching of physics (thematic units: Electromagnetic radiation, Optics - blackbody radiation).

Basic knowledge: Thermography is a measuring method, which allows you to display graphically the temperature on the surface of the object being tracked. Infrared radiation is emitted by all bodies whose temperature is above absolute zero.

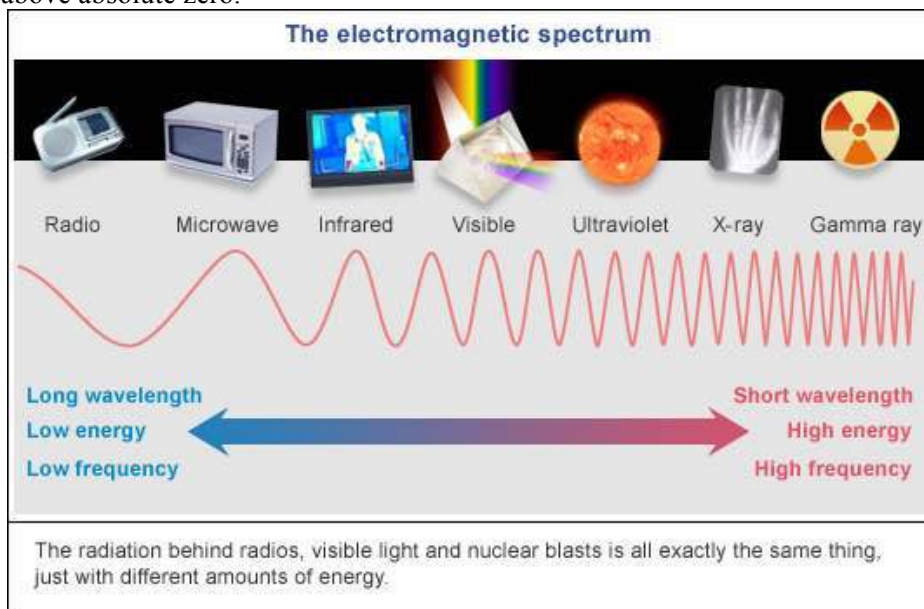

Figure 2. The electromagnetic spectrum (<http://www.abc.net.au/science/articles/2010/02/18/2817543.htm>)

Relations, which are used in thermography and which are part of the school curriculum:

- Planck's law

Planck's law expresses the dependence of the intensity of blackbody radiation on the thermodynamic temperature and wavelength. The claim is based on the observation that each body having a surface temperature above absolute zero emits electromagnetic radiation with a wavelength corresponding to its temperature.

$$W_{\lambda b} = \frac{2\pi hc^2}{\lambda^5 \left(e^{\frac{hc}{\lambda kT}} - 1 \right)} \cdot 10^{-6} [\text{W} \cdot \text{m}^{-3}],$$

where $W_{\lambda b}$ is the spectral density of the intensity of black body radiation at wavelength λ , c is the speed of light ($3 \cdot 10^8 \text{ m} \cdot \text{s}^{-1}$), h is Planck's constant ($6.626 \cdot 10^{-34} \text{ J} \cdot \text{s}$), k is Boltzmann's constant ($1.381 \cdot 10^{-23} \text{ J} \cdot \text{K}^{-1}$), T is absolute temperature of the black body (K) and a λ - wavelength (m).

- Wien's displacement law

The Law describes the change in wavelengths at which blackbody energy is radiated in dependence on the change of thermodynamic temperature $\lambda_{\max} = b / T$ (m), where λ_{\max} is the wavelength of maximum emission, T is the thermodynamic temperature of a black body, and b is Wien constant ($b = 2.898 \cdot 10^{-3} \text{ m} \cdot \text{K}$).

- Stefan- Boltzmann law

Stefan- Boltzmann law describes the overall intensity of blackbody radiation. The law says that the intensity of the radiation increases in direct proportion to the fourth power of the thermodynamic temperature of the radiating body. However, in real conditions we cannot meet with absolutely black body; hence we need to complement Stefan- Boltzmann relation with the emissivity ε of the body.

$$W_b = \varepsilon \sigma T^4 \text{ [W/m}^2\text{]},$$

where W_b means the spectral density of the intensity of black body radiation, ε is body emissivity, σ is the Stefan- Boltzmann constant ($\sigma = 5.670 \cdot 10^{-8} \text{ W} \cdot \text{m}^{-2} \cdot \text{K}^{-4}$) and T is the thermodynamic temperature [K]

- Thermogram

The output from the thermal imaging camera is an infrared image called a thermo gram, or thermal image. Thermal imagers allow the user to determine the temperature at each point of the thermo gram. Infrared light is invisible to the human eye, for this reason, infrared images are visualized in the visible spectrum using different colour palettes, which are assigned to each of different colour temperatures. Among the most frequently discovered palette colours in thermography are: polar ice, iron, and rainbow.

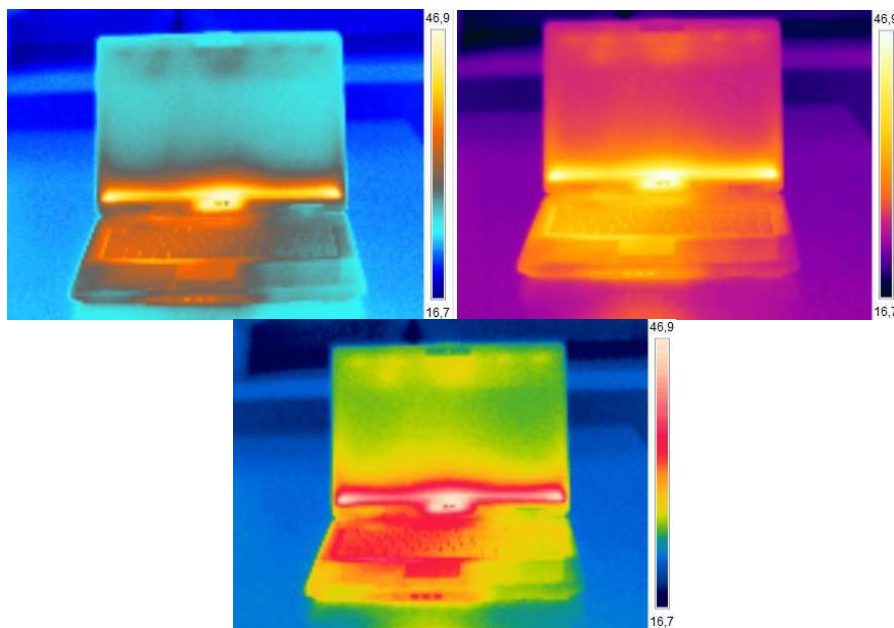

Figure 3. Palette – polar ice, iron, rainbow

3.3 The use of thermography in practice – experimental activities (suggestions)

- Construction – loss of heat on the surface of building structures, insulation, structural defects
- Healthcare - in plastic surgery: control of graft healing, diagnosis of various inflammations, or poor circulation. Using a camera with higher sensitivity we can also diagnose malignant tumours, deposits of infections.
- Industry, electrical engineering - inspection of electrical circuits
- Criminology - identification of individuals using the thermo gram of the earlobes as, for example, search of people in a smoky room.

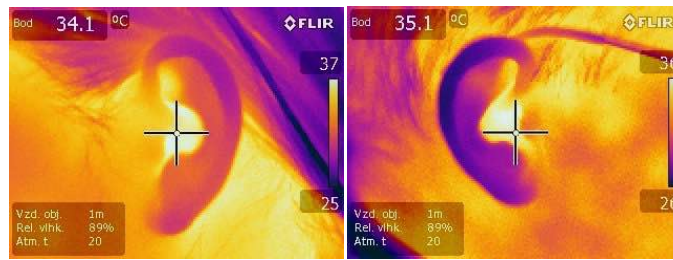

Figure 4. Thermograms of two different people earlobes

- Culinary physics – linked to the topics: transport of heat, thermal conductivity we can show the process of liquids heating with gas cookers, induction hobs. It is interesting to observe thermo gram during ice cubes melting in liquids of different density (linked to environmental issues - global warming, melting glaciers).
- Environmental issues - thermal imager can detect errors in solar panels.

Damaged cells can cause abnormal heating - and therefore they can cause a fire. In addition, damaged cells can cause substantial loss of performance of the whole system (the whole module strings).



Figure 5. Defect in a solar panel

3.4 USB microscope and its use

USB microscope can be connected to a PC, a laptop or a tablet and observe objects in their live image, capture images, save them in the format and later work with them. Observation is simpler than with a light microscope and in the normal school environment it has sufficient magnification. Objects that can be observed have dimensions from dozens to thousands of microns. Within the module Physics and criminology we can use this microscope to analyse fibres and hair, observe small objects found at the „crime scene“. For teaching optics it is possible to demonstrate the mixing of colours – display individual pixels.



Figure 6. USB microscope – hair and instant coffee

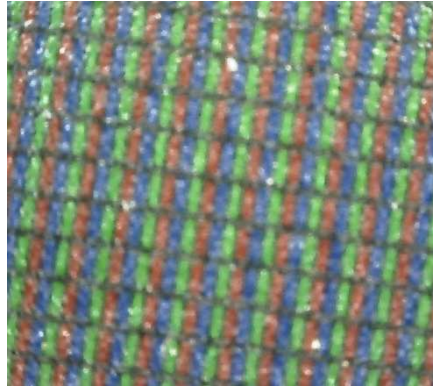

Figure 7. USB microscope – RGB sub pixels

4. Conclusion

In our research it was found out that the factors that have a great influence on the interest in physics learning deals with the content of the topic, the type of the activity, the methods.

As it was noted above, students are motivated to learn physics if they can use modern information technology, computers, internet, mobile phones. The majority of schools are good equipped with multimedia. Teachers use them rarely; they are not able to take advantage of these teaching aids. Reason for it can be lack of skills and unwillingness to learn something new. We tried to design a variety of activities, where these devices could be effectively and meaningfully used. The process of learning is more attractive and thus contributing to the acquisition of competences defined by the school curriculum. Also the content of physics lessons has done meaningful and relevant to learners. Technical applications are not interesting for all students but on the other hand the life without technology is not possible. Technical applications must be combined with human being – for example in culinary physics or in criminology. This approach in physics education is very important because in the last two years we can corroborate the growing interest of students to take part in activities based on our new modules (see Figure 8). The summer school <http://www.pevnostpoznani.cz/tabory>, or The European Researchers' Night <http://www.pevnostpoznani.cz/noc-vedcu> are in the centre of interest. The number of our physics teacher graduates is growing too – in 2012 and 2013 there were 2 graduates, one year later there were 10 graduates. A successful classroom embraces problem solving, critical thinking, interdisciplinary themes, the best use of technology, motivation.



Figure 8. Kaleidoscope of physics (<http://kaleidoskop.upol.cz/>)

References

- Holubová, R. (2013). Innovations in physics' teacher education. *Proceedings of The International Conference on Physics Education, Active learning – in a changing world of new technologies*, ICPE-EPEC, 459-466.
- Janík, T. et al (2009). *The Power of Video Studies in Investigating Teaching and Learning in the Classroom*. Waxmann, Münster, Empirische Bildungsforschung.
- MacLeod, K. (2013). Physics Education and STSE: Perspectives From the Literature, *European J of Physics Education* **4**, 86 – 94.
- Prensky, M. (2001). Digital natives, digital immigrants. From *On the Horizon (MCB University Press*, **9** (5).
- Schofield, C.P. and Honoré, S.(2010). Generation Y and learning. *The Ashridge Journal Generation Y and Learning*. Winter 2009-2010.
- Stioca, I., Moraru, S. and Miron, C. (2011). Concept maps, a must for the modern teaching-learning process. *Romanian Reports in Physics*, **63**, 567–576.
- Tapscott, D. (2008). *Grown Up Digital: How the Net Generation is Changing Your World*, McGraw Hill, New York, USA.
- Zounek, J. and Sedova, K. (2009). *Učitelé a technologie. Mezi tradičním a moderním pojetím*. Brno: Paido.
- PISA 2012 Results in Focus*. OECD 2014. [on-line 2014-09-24 <http://www.oecd.org/pisa/keyfindings/pisa-2012-results-overview.pdf>]

Affiliation and address information

Renata Holubova
Palacky University, Faculty of Science
Department of Experimental Physics
17. listopadu 1192/12
77146 Olomouc
Czech Republic
e-mail: renata.holubova@upol.cz

Students' Misconceptions Regarding Everyday Thermal Phenomena

Petr Kacovsky

Charles University in Prague

Faculty of Mathematics and Physics, Department of Physics Education

Abstract

Thermodynamics belongs to the largest areas in the Czech physics curricula. On every school level this area is conceptually very rich and uses terms that are familiar from everyday life but have different meanings in physics. Such a language conflict can form or even strengthen students' intuitive incorrect beliefs – misconceptions. This contribution describes a research focused on students' misconceptions in the context of common, everyday thermal phenomena.

In order to identify typical students' misconceptions in this field, the Thermal Concept Evaluation (TCE) test was chosen. Since September 2013, more than 500 secondary school students from 23 classes have filled in this test twice – both as a pretest and as a posttest. Besides questions regarding thermal phenomena, the test included a few attitudinal questions to learn additional information about the students.

Keywords

students' misconceptions, Thermal Concept Evaluation, thermodynamics, secondary school

1. Introduction

As mentioned above, in the Czech curriculum, thermodynamics is one of the largest topics in secondary school physics, together with mechanics and electricity and magnetism. Unfortunately, according to brief literature search, this topic is (especially in comparison with the two above mentioned topics) quite poor in experiments which would be able to attract students' attention. To develop such experiments and inquiry based activities associated with them, it is at first necessary to have an overview of typical students' difficulties in thermodynamics – their misconceptions.

The concept of misconceptions is connected with constructivism [Piaget, 1928; Piaget, 1952] which claims that students bring their past experience, their prior knowledge, to every learning situation. This prior experience called preconceptions [e.g. Clement, 1993] is formed due to the students' natural interaction with their surroundings. Preconceptions can be consistent with the scientific theories – so called anchoring conceptions [Clement, Brown and Zietsman, 1989] – or inconsistent with them – so called misconceptions [e.g. Gilbert and Watts, 1983].

2. Terminology

It is suitable to emphasize that concerning terminology, there is a lack of consensus in this field. Many researchers refuse the term *misconceptions* and use its equivalents or modifications, such as *alternative conceptions* [e.g. Hewson and Hewson, 1984; Wenning 2008], *alternative frameworks* [Driver, 1983], *naive conceptions* [Bliss and Ogborn, 1994], *naive beliefs* [McCloskey, Caramazza and Green, 1980], etc. In this contribution, the term “misconceptions” will be preferred because of its widespread use and familiarity.

3. The Thermal Concept Evaluation (TCE) test

On the basis of the literature search outcomes concerning surveys in the field of alternative conceptions in thermodynamics, two most frequently used conceptual tests came up – the Thermal Concept Evaluation [Yeo and Zadnik, 2001] and the Heat and Temperature Conceptual Evaluation [Sokoloff and Thornton 2003]. While the first of these (shortly TCE) consists strictly of multiple choice questions with four (exceptionally five) possible answers, the latter (shortly HTCE) contains multiple-choice questions with four to eight options, but also one productive question. Above all, there is a big difference in using graphic elements – while the HTCE uses them quite often, the TCE completely avoids them.

Mainly due to the uniformity of items and less amount of longer texts I chose the TCE as my research tool. It was originally developed by Shelley Yeo and Marjan Zadnik at Curtin University in Perth (Australia) in 2001 as an extract from the literature on students' beliefs about thermal phenomena. Originally it consists of

26 multiple-choice questions mainly inspired by common, everyday situations (in the household, at school, on a trip etc.), which enables its use both on primary and secondary school level, respectively on universities. The full text of this concept inventory was published in *The Physics Teacher* in 2001.

4. Use of the TCE in the world

Since its creation in 2001, the TCE has been used in countries all over the world. In this paragraph, the most important studies using the TCE (both in its full and reduced version) are stated chronologically.

Australia, 2001 [Yeo and Zadnik, 2001]

The authors themselves used their inventory to test 478 Western Australian students in four consecutive year grades (from 10 to 13) in nine different institutions. The inventory was administered both as a pretest and a posttest only in the grade 13, which represents the first year on university.

USA, 2003 [Luera, Otto and Zitzewitz, 2005]

At the University of Michigan-Dearborn, the TCE was used both as a pretest and a posttest to assess the effectiveness of activities based on so called misconception-guided instruction. Almost 50 students (aged from 21 to 45 years), who participated in the study, were enrolled in a science capstone course during the fall 2003; all of them were either seniors or post-baccalaureates. The average percentage of correct responses increased from 35 % (in the pretest) to 57 % (in the posttest), resulting in a normalized gain $g = 34$ %.

Turkey, 2006 [Baser, 2006]

Translated and adapted to Turkish, the TCE was used at the Department of Elementary Education of Izzet Baysal University to assess the effectiveness of the cognitive conflict based instruction. The experimental group of 42 students taught this way, reached the normalized gain $g = 43$ %, while the control group of 40 students who underwent traditional instruction reached only $g = 15$ %.

Australia, 2008 [Georgiou et al., 2009]

Six questions of the TCE – number 1 to 6 – were chosen as a part of a test (12 multiple choice + 3 free response questions) which aimed at examining conceptions of first and second year university physics students at the University of Sydney.

Libya, 2010 [Alwan, 2011]

At the Al.fateh University in Tripoli, the Heat and Temperature Concepts Questionnaire (HTCQ) was established to find out misconception of 53 students in the field of heat and temperature. In fact, this test consisted mainly of the TCE questions – 26 of 30 items of HTCQ originated from Yeo and Zadnik.

South Korea, 2012 [Chu et al., 2012]

Two years ago, the TCE was administered to more than five hundred Korean students in grades from 10 to 12.

5. The Czech version of the TCE

In March 2013, the TCE was translated into Czech; the translation was discussed with experts of the Department of Physics Education (Faculty of Mathematics and Physics, Charles University in Prague) and with experienced secondary school teachers. During May and June 2013, the pilot study was held on the sample of 72 secondary school students, and on the basis of its results and the experts' opinion, the Czech version of the TCE (CTCE) was finally reduced into its present form which includes 19 multiple-choice questions. Questions 12, 13, 14, 15, 20, 21 and 26 contained in the original version of the TCE were excluded, and that mainly because of two reasons. In the pilot study, questions 12, 20, 21 and 26 showed very low index of item discrimination [Chu et al., 2012], i.e. below 0.20, which means that these questions are barely able to distinguish between good and poor students. Further, questions 13 and 14 were excluded due to its similarity to another test question and in the case of the question 15 there wasn't found an appropriate and unambiguous Czech translation.

The English version of the CTCE is attached to this contribution as an Appendix and all question numbers which occur in the following text are related to the CTCE question numbering.

Pre-test

The majority of Czech secondary school students meets the topic of molecular and thermal physics in the second year of their studies (grade 11); typically, they deal with this part of physics from September for four, five, six or seven months (it depends on the school). For this reason, it was necessary to administer the CTCE during the first two or three weeks in September on as many schools as possible. To have the administration under control, I decided to visit almost all schools (with two exceptions) in person.

Between the 3rd of September and 10th of October 2013, 586 secondary school students (341 girls and 245 boys) aged between 16 and 18 years, filled in the CTCE. Considering every question as one point, the average students' score was 8.7 points, which represents the gain of 46 %. Boys with the average score of 10.2 points (53 %) were notably more successful than girls (average score 7.6 points, i.e. 40 %). There were no students with 0, 1 or 19 points; the most frequent gain was 6 points.

The Cronbach's alpha, which represents the reliability of the test, was 0.70 in the pretest.

Post-test

The posttest was administered in every class just after finishing the topic of thermal phenomena, typically in shorter time than three weeks. The average score in the posttest was 11.0, which results in normalized gain of $g = 0.23$. This value indicates low effectiveness of instruction, which is not surprising inasmuch as the majority of Czech teachers use traditional teacher-centered approach which often doesn't exceed the level of $g > 0.30$ regarded as a bottom border of a moderately effective instruction [Hake, 1998]. At the conference time, the posttest data were still being evaluated, so there is no deeper analysis described in this contribution concerning comparison between the pretest and posttest scores. For this reason, the item analysis in the next paragraph involves only the pretest data.

Pre-test item analysis

The average students' results in the CTCE pretest ranged depending on the question between 21 % (question 11) and 81 % (question 16) of correct answers; the scores reached in each question are summarized in the Figure 1. If we consider the questions with lowest ratio of correct answers, we get two thematic units which for students are probably more difficult than others.

The first problematic part of thermodynamics identified by CTCE pretest can be called "boiling and evaporation" – among four questions with the worst average gain, three of them (questions no. 5, 6 and 13) are focused just on boiling and evaporation problems.

The second group of questions with quite bad gains is linked together by the concept of heat conductivity – for example questions no. 12, 14 and 18, which deal with this topic, were correctly answered by less than 40 % students.

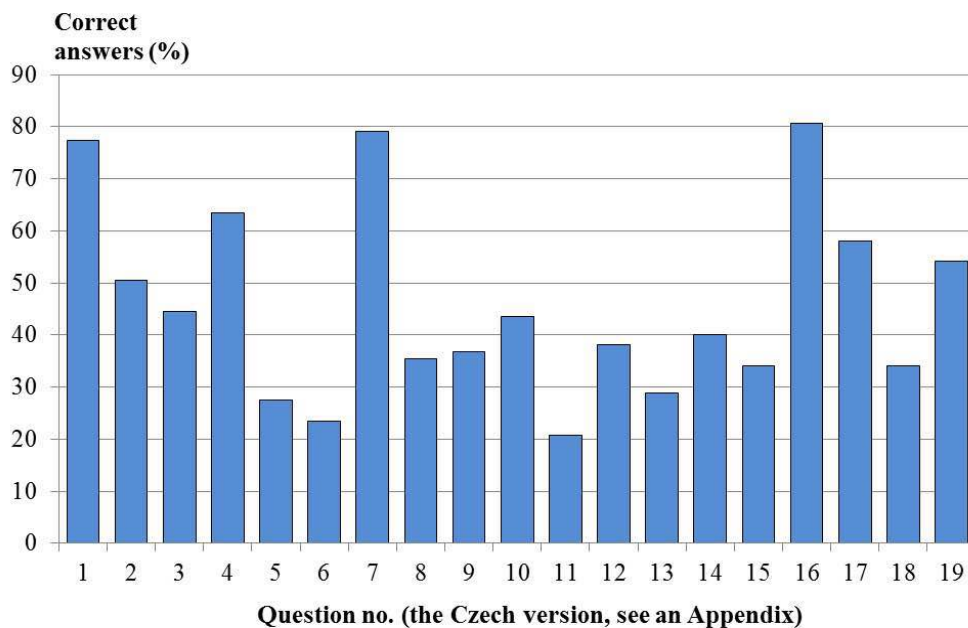

Figure 1. Average scores reached in the pretest in every question.

Attitudinal questions

Besides the questions regarding thermal phenomena, the test includes four attitudinal questions to learn additional information about students. The goal of these questions is to look into possible relationships and correlations between the students' scores and their attitudes towards physics.

On the scale from 1 to 6 students should express their agreement or disagreement with these four statements (S1 to S4):

- S1: I expect I will need physics in the future (at university, in work).
- S2: Physics is useful for society.
- S3: Physics is useful for me.
- S4: I enjoy physics, physics entertains me.

On the above mentioned scale, the choice of number 1 means "I totally agree" while the choice of number 6 means "I totally disagree". In the Table 1, the average values reached in the statements S1 to S4 are summarized and completed with the comparison of boys' and girls' attitudes. At first sight it is evident that girls are more critical to physics and its usefulness in general:

Table 1. Average values reached in statements S1 to S4, sample of 586 secondary school students. The value 1 means "I totally agree", the value 6 means "I totally disagree".

statement	average value (all students)	average value (girls)	average value (boys)
S1	3.8	4.2	3.3
S2	2.2	2.3	2.1
S3	3.3	3.5	3.0
S4	3.8	4.1	3.5

6. Conclusions and future plans

Altogether, 586 Czech secondary school students were involved in the study focusing on their misconceptions in the field of everyday thermal phenomena. Using a Czech version of the TCE test, the topics of thermal conductivity and boiling and evaporation were identified as those most difficult for the respondents.

In the next school year, the testing will continue in order to involve schools in regions further from the Czech capital Prague. After evaluation of the posttest data, the results of Czech students will be compared with the results obtained by previous foreign studies and the most problematic topics will be identified and investigated using qualitative methods; in addition they provide an inspiration to developing suitable simple experiments designed to face misconceptions in the field of thermal phenomena. Concurrently, possible correlations between students' results and their attitudes towards physics will be analysed.

Acknowledgment

The work is supported by The Charles University Grant Agency (GAUK), grant No. 1860214.

References

- Alwan, A. (2010). Misconception of Heat and Temperature Among Physics Students. *International Conference on Education and Educational Psychology ICEEPSY 2010*.
- Baser, M. (2006). Fostering conceptual change by cognitive conflict based instruction on students' understanding of heat and temperature concepts. *Eurasia Journal of Mathematics, Science and Technology Education*, 2 (2).
- Bliss, J., Ogborn, J. (1994). Force and motion from the beginning. *Learning and Instruction*, 4, 7–25.
- Clement, J., Brown, D. E., Zietsman, A. (1989). Not all preconceptions are misconceptions: Finding "anchoring conceptions" for grounding instruction on students' intuitions. *International Journal of Science Education*, 11, 554 – 565.

- Clement, J. (1993). Using bridging analogies and anchoring intuitions to deal with students' preconceptions in physics. *Journal of Research in Science Teaching*, 30 (10), 1241-1257.
- Driver, R. (1983). *The pupil as scientist?* Milton Keynes: Open University Press.
- Georgiou, H., Sharma, M., O'Byrne, J., Sefton, I., McInnes, B. (2008). University students' conceptions about familiar thermodynamic process and the implications for instruction. *The UniServe Science 2008 Conference proceedings*.
- Gilbert, J., Watts, D. (1983). Concepts, misconceptions and alternative conceptions: Changing perspectives in science education. *Studies in Science Education*, 10, 61-98.
- Hake, R. (1998). Interactive-engagement versus traditional methods: A six-thousand-student survey of mechanics test data for introductory physics courses. *Amer. J. Phys.*, 66.
- Chu, H. – E., Treagust, D. F., Yeo S., Zadnik, M. (2012). Evaluation of Students' Understanding of Thermal Concepts in Everyday Contexts. *International Journal of Science Education*, 34 (10).
- McCloskey, M., Caramaza, A., Green, B. (1981). Naive beliefs in "sophisticated" subjects: Misconceptions about trajectories of objects. *Cognition*, 9, 117-123.
- Luera, G. R., Otto, Ch., Zitzewitz, P. W. (2005). A conceptual change approach to teaching energy and thermodynamics to pre-service elementary teachers. *Journal of physics teacher education*, 2 (4).
- Piaget, J. (1928). *The child's conceptions of the world*. London: Routledge and Kegan Paul.
- Piaget, J. (1952). *The origins of intelligence in children*. New York: International University Press.
- Sokoloff, D. R., Thornton, R. K. (2003). *Heat and Temperature Conceptual Evaluation*. Available at URL: http://physics.dickinson.edu/~wp_web/wp_resources/wp_assessment.html.
- Wenning, C. J. (2008). Dealing more effectively with alternative conceptions in science. *Journal of Physics Teacher Education Online*, 5 (1), 11-19.
- Yeo, S., Zadnik, M. (2001). Introductory Thermal Concept Evaluation: Assessing Students' Understanding. *The Physics Teacher*, 39.

Affiliation and address information

Petr Kacovsky
Faculty of Mathematics and Physics
Department of Physics Education,
Charles University in Prague
V Holesovickach 2
180 00 Prague
Czech Republic
e-mail: petr.kacovsky@mff.cuni.cz

Appendix: The TCE – questions involved in the Czech version (CTCE)

<p>1. What is the most likely temperature of ice cubes stored in a refrigerator's freezer compartment?</p> <p>a) $-10\text{ }^{\circ}\text{C}$ b) $0\text{ }^{\circ}\text{C}$ c) $5\text{ }^{\circ}\text{C}$ d) It depends on the size of the ice cubes.</p>	<p>2. Jirka takes six ice cubes from the freezer and puts four of them into a glass of water. He leaves two on the countertop. He stirs and stirs until the ice cubes are much smaller and have stopped melting. What is the most likely temperature of the water at this stage?</p> <p>a) $-10\text{ }^{\circ}\text{C}$ b) $0\text{ }^{\circ}\text{C}$ c) $5\text{ }^{\circ}\text{C}$ d) $10\text{ }^{\circ}\text{C}$</p>
<p>3. The ice cubes Jirka left on the counter have almost melted and are lying in a puddle of water. What is the most likely temperature of these smaller ice cubes?</p> <p>a) $-10\text{ }^{\circ}\text{C}$ b) $0\text{ }^{\circ}\text{C}$ c) $5\text{ }^{\circ}\text{C}$ d) $10\text{ }^{\circ}\text{C}$</p>	<p>4. On the stove is a kettle full of water. The water has started to boil rapidly. The most likely temperature of the water is about:</p> <p>a) $88\text{ }^{\circ}\text{C}$ b) $98\text{ }^{\circ}\text{C}$ c) $110\text{ }^{\circ}\text{C}$ d) $120\text{ }^{\circ}\text{C}$</p>
<p>5. Five minutes later, the water in the kettle is still boiling. The most likely temperature of the water now is about:</p> <p>a) $88\text{ }^{\circ}\text{C}$ b) $98\text{ }^{\circ}\text{C}$ c) $110\text{ }^{\circ}\text{C}$ d) $120\text{ }^{\circ}\text{C}$</p>	<p>6. What do you think is the temperature of the steam above the boiling water in the kettle?</p> <p>a) $88\text{ }^{\circ}\text{C}$ b) $98\text{ }^{\circ}\text{C}$ c) $110\text{ }^{\circ}\text{C}$ d) $120\text{ }^{\circ}\text{C}$</p>
<p>7. Ivana takes two cups of water at $40\text{ }^{\circ}\text{C}$ and mixes them with one cup of water at $10\text{ }^{\circ}\text{C}$. What is the most likely temperature of the mixture?</p> <p>a) $20\text{ }^{\circ}\text{C}$ b) $25\text{ }^{\circ}\text{C}$ c) $30\text{ }^{\circ}\text{C}$ d) $50\text{ }^{\circ}\text{C}$</p>	<p>8. Petr believes he must use boiling water to make a cup of tea. He tells his friends: "I couldn't make tea if I was camping on a high mountain because water doesn't boil at high altitudes."</p> <p>a) Martin says: "Yes it does, but the boiling water is just not as hot as it is here." b) Pavel says: "That's not true. Water always boils at the same temperature." c) Jakub says: "The boiling point of the water decreases, but the water itself is still at 100 degrees." d) Tomáš says: "I agree with Petr. The water never gets to its boiling point."</p> <p>Who do you agree with?</p>
<p>9. Petra takes a can of cola and a plastic bottle of cola from the refrigerator, where they have been overnight. She quickly puts a thermometer in the cola in the can. The temperature is $7\text{ }^{\circ}\text{C}$. What are the most likely temperatures of the plastic bottle and cola it holds?</p> <p>a) They are both less than $7\text{ }^{\circ}\text{C}$. b) They are both equal to $7\text{ }^{\circ}\text{C}$. c) They are both greater than $7\text{ }^{\circ}\text{C}$. d) The cola is at $7\text{ }^{\circ}\text{C}$ but the bottle is greater than $7\text{ }^{\circ}\text{C}$. e) It depends on the amount of cola and/or the size of the bottle.</p>	<p>10. A few minutes later, Petra picks up the cola can and then tells everyone that the countertop underneath it feels colder than the rest of the counter.</p> <p>a) Tereza says: "The cold has been transferred from the cola to the counter." b) Jitka says: "There is no energy left in the counter beneath the can." c) Katka says: "Some heat has been transferred from the counter to the cola." d) Eliška says: "The can causes heat beneath the can to move away through the countertop."</p> <p>Whose explanation do you think is best?</p>
<p>11. Roman asks one group of friends: "If I put 100 grams of ice at $0\text{ }^{\circ}\text{C}$ and 100 grams of water at $0\text{ }^{\circ}\text{C}$ into a freezer, which one will eventually lose the greatest amount of heat?"</p> <p>a) Honza says: "The 100 grams of ice." b) Marek says: "The 100 grams of water." c) Milan says: "Neither because they both contain the same amount of heat." d) Patrik says: "There's no answer, because ice doesn't contain any heat." e) Aleš says: "There's no answer, because you can't get water at $0\text{ }^{\circ}\text{C}$."</p> <p>Which of his friends do you most agree with?</p>	<p>12. Jana takes a metal ruler and a wooden ruler from her pencil case. She announces that the metal one feels colder than the wooden one. What is your preferred explanation?</p> <p>a) Metal conducts energy away from her hand more rapidly than wood. b) Wood is a naturally warmer substance than metal. c) The wooden ruler contains more heat than the metal ruler. d) Metals are better heat radiators than wood. e) Cold flows more readily from a metal.</p>

13. Dita took two glass bottles containing water at 20 °C and wrapped them in washcloths. One of the washcloths was wet and the other was dry. Twenty minutes later, she measured the water temperature in each. The water in the bottle with the wet washcloth was 18 °C, the water in the bottle with the dry washcloth was 22 °C. The most likely room temperature during this experiment was:

- a) 26 °C
- b) 21 °C
- c) 20 °C
- d) 18 °C

15. Bára reckons her mother cooks soup in a pressure cooker because it cooks faster than in a normal saucepan but she doesn't know why.

- a) Kristýna says: "It's because the pressure causes water to boil above 100°C."
- b) Eva says: "It's because the high pressure generates extra heat."
- c) Karolína says: "It's because the steam is at a higher temperature than the boiling soup."
- d) Andrea says: "It's because pressure cookers spread the heat more evenly through the food."

Which person do you most agree with?

17. Why do we wear sweaters in cold weather?

- a) To keep cold out.
- b) To generate heat.
- c) To reduce heat loss.
- d) All three of the above reasons are correct.

18. Filip takes some Popsicles from the freezer, where he had placed them the day before, and tells everyone that the wooden sticks are at a higher temperature than the ice part. Which person do you most agree with?

- a) Radek says: "You're right because the wooden sticks don't get as cold as ice does."
- b) Luboš says: "You're right because ice contains more cold than wood does."
- c) Viktor says: "You're wrong, they only feel different because the sticks contain more heat."
- d) Štěpán says: "I think they are at the same temperature because they are together."

14. Pavel simultaneously picks up two cartons of chocolate milk, a cold one from the refrigerator and a warm one that has been sitting on the countertop for some time. Why do you think the carton from the refrigerator feels colder than the one from the countertop? Compared with the warm carton, the cold carton —

- a) contains more cold.
- b) contains less heat.
- c) is a poorer heat conductor.
- d) conducts heat more rapidly from Pavel's hand.
- e) conducts cold more rapidly to Pavel's hand.

16. When Ondra uses a bicycle pump to pump up his bike tires, he notices that the pump becomes quite hot. Which explanation below seems to be the best one?

- a) Energy has been transferred to the pump.
- b) Temperature has been transferred to the pump.
- c) Heat flows from his hands to the pump.
- d) The metal in the pump causes the temperature to rise.

19. Lenka is describing a TV segment she saw the night before: "I saw physicists make super-conductor magnets, which were at a temperature of -260 °C."

- a) Radim doubts this: "You must have made a mistake. You can't have a temperature as low as that."
- b) Dominik disagrees: "Yes you can. There's no limit on the lowest temperature."
- c) Matyáš believes he is right: "I think the magnet was near the lowest temperature possible."
- d) Tonda is not sure: "I think super-conductors are good heat conductors so you can't cool them to such a low temperature."

Who do you think is right?

A Platform to Support CO₂ Emissions Mapping on the Aegean Sea Islands

Barbara Kasselouri¹, Harry Kambezidis², Alexis Kaselouris³, Dimitrios Zevgolis⁴

¹ *Hellenic Open University*

² *National Observatory of Athens*

³ *Harokopio University, Department of Geography*

⁴ *Hellenic Open University, School of Applied Arts*

Abstract

The present study is part of a multimedia application, adequate for environmental education and awareness regarding the fossil fuels combustion and its consequences at the secondary and university level. The application consists of a software platform that has the objective of proposing a scenario for the highest possible RES-E (Renewables Energy Sources Electricity) penetration in the Greek electricity network up to 2050. For this reason the present study considers the electricity production on the non-interconnected Aegean Sea islands that depends almost exclusively on oil combustion. The electricity produced by RES on the non-interconnected islands increased from 7% (2000) to 15% (2012). A database is created consisting of the monthly electricity production (2000-2012) per thermal power plant (TPP), RES-type and island. The National Inventories, the Energy Balances and the annual verified CO₂ emissions (2005-2012) of the power plants that participate in the EU Emission Trading Scheme are also exploited for the estimations of the emissions. Estimation of the annual CO₂ emissions and their disaggregation at monthly and individual TPP level for 2000-2012 is accomplished by a methodology, especially developed for this purpose. A GIS-based platform is created that includes the administrative divisions of Greece, the TPPs and the connections between islands. The included CO₂ maps are implemented using the kriging geostatistical method for spatially interpolating the CO₂ values at annual/ monthly level. In a computer laboratory environment, where adequate GIS software is available, the educator can guide the students to work with GIS software and visualize CO₂ emissions, in other words to “transform” numbers in colour images; to transform facts like the seasonality of the increased emissions in summertime in easy to remember patterns. The students can create maps/images for selected months’/years’ CO₂ emissions, since the aforementioned disaggregation results are embedded in the deliverable material (shp files). Finally the students can be guided to pump information from the derived maps/images, discuss and draw conclusions for issues that directly or indirectly influence the environment. For example issues like: the possibility of greater RES-E penetration in electricity production in order to cover the increasing demand that a desired development would cause and the corresponding CO₂ emissions decrease, the increase of security of supply of electricity, the decrease of imported fuels and their substitution with local renewable “fuels”, like biomass, wind, sun etc.

Keywords

Secondary education: upper (ages about 15-19) & University education

ICT in Environmental education

CO₂ emissions mapping

1. Introduction

The detailed study of the Greek electricity system is necessary in order to develop the aforementioned electricity production database; additionally it represents a prerequisite for the educator that will apply the proposed methodology to deal with concepts like isolated electrical systems and their particularities, CO₂ emissions from oil combustion, CO₂ emissions mapping, seasonality of increased/reduced emissions etc. A description of the Aegean Sea islands electricity system along with facts about them that influence the electricity demand follow.

The Greek electricity system is divided into (i) the interconnected mainland system, based mainly on lignite power plants, and (ii) the non-interconnected islands system that depends mainly on thermal power plants that consume imported oil. The electricity produced by RES (small hydro, wind farms and PV included) increased from 7% in 2000 to 15% in 2012 (18.5% in 2013 that lies close to the maximum system’s absorption capability).

The greatest part of the electricity production on the islands is generated by Thermal Power Plants (TPPs) that use heavy fuel oil in steam turbines and diesel in internal combustion engines. The total oil thermal power plants installed capacity on the non-interconnected islands was 1,758 MW for all 35 TPPs at the end of 2012 (1.684 MW at the end of 2013). The mean variable cost of a thermal MWh on the islands follows the international changes of oil prices. For example, the mean variable cost of the thermal MWh correlated with the Europe Brent Spot Prices with a correlation coefficient of 96.9% for the period 2007-2012 (RAE, 2008a), (RAE, 2009), (RAE, 2011), (RAE, 2012), (U.S. EIA).

19 of the 35 TPPs have been registered in the EU Emission Trading Scheme (EU ETS). These 19 TPPs represent 98.64% on average of the total thermal electricity production on the islands from 2000 to 2012 (small amounts of production on islands that meanwhile have been connected to mainland's grid not included, e.g. Andros). According to the European Commission's (EC) Union Registry available data on allocated and verified CO₂ emissions (EC, 2013) from 2005 to 2009, the verified emissions for the 19 TPPs exceeded the allocated ones from 0.46% (in 2005) to 17.01% (in 2009) – following the steadily increasing demand. As it can be seen in Figure 1 the total electricity production (thermal and RES-E) on the islands during the last years seems to stop its increasing tendency; this fact could be attributed to the fiscal and economic crisis that Greece is facing since 2009. Additionally the increase in RES-E production (see Figure 1) on the island of Crete led finally to a change on the increasing tendency of the yearly exceeded CO₂ 2005-2009 emissions since 2010 (EC, 2013).

The population of the islands represents approximately the 10% of the country's total according to 2011 population census (HSA, 2013a). During summer time the population becomes 2-5 times as much in the majority of the islands due to tourism. Consecutively the seasonal character of the peak demands constitutes the most important technical constraint as regards RES-E penetration issues. Crete represents the biggest share in electricity production on the non-interconnected islands (see Figure 2). For example the 817MW installed capacity (2012) of 3 TPPs (no other island has even a second TPP) constitutes the 46.5% of the total thermal installed capacity; Crete's population constitutes the 55% of the aforementioned 10% population's share of the islands to country's total population (HSA, 2013a). Rhodes follows with its 233MW thermal installed capacity and its 10.4% share on islands population (the small island of Halki included; it's connected to Rhodes by underwater cable for its electrification) (HSA, 2013b). Very small islands like Arki, Donoussa, Agathonisi and Othoni, have thermal installed capacity about half of 1 MW and population of 44, 147, 185 and 392 persons respectively, according to 2011 census (HSA, 2013b).

The 35 TPPs cover the electricity needs of 57 non-interconnected islands, 55 in the Aegean Sea and the 2 very small islands of Erikoussa and Othoni with their own TPP, which are geographically located in the Ionian Sea. Except of Antikythira and Skyros islands, which belong to Attica and Evia prefectures, respectively, the rest 53 islands belong to the following prefectures: Dodecanese, Crete, Cyclades, Lesvos, Samos, Icaria and Chios (Kasselouti et al., 2011). The electrification of the 54 Aegean islands (Crete with 3 TPPs excluded) from 30 TPPs is covered by underwater medium-voltage connections between the islands (PPC, 2009). For a quick overview see the map in Figure 2. The classification of 2012's thermal electricity production in the 35 TPPs – 33 islands on the map - has been made using 10 classes and applying the Jenks natural breaks classification method (Washington & Jefferson Coll., 2009). The islands that get electricity through the underwater connections (24 in total) are distinguished on the map of Figure 2 in lowercase letters. In some cases the seasonal peak demands are covered with portable units (diesel generators). As regards Crete's electricity production there is no such distinction (portable or not) in the data obtained from the Public Power Corporation (PPC) (period 2000-2009). For the island of Rhodes the production by portable units is included in the electricity production database. According to the most recent data from PPC, 17% of the units used in the summer of 2012 consisted of portable ones.

2. Data collection and analysis

In the following paragraphs a description of the work required to support the final deliverable of the present study follows. More specifically in the first 2 paragraphs the analysis is to be found that brought the available data of the electricity production and the corresponding CO₂ emissions in the form required to create annual and monthly CO₂ emissions maps on the Greek non-interconnected islands for the period 2000-2012. This section also includes the documentation of the basic choices regarding the proposed CO₂ emissions mapping process.

2.1. Electricity production

As already mentioned the TPPs on the islands use oil exclusively.

The monthly electricity production per TPP on the islands for the period 2000-2009 has been obtained from PPC together with the RES-E production. Since January 2010 PPC reports generalized monthly data of the RES-E

production on the non-interconnected islands on its website (PPC, 2013). Since January 2011 these reports also include the monthly thermal electricity productions of the 13 islands with the highest installed capacity; in other words the monthly production of 15 TPPs (Crete with its 3 TPPs included). The rest 20 TPPs represent 6.9% of the thermal installed capacity for the specific year (PPC, 2013). As regards 2010's thermal electricity production on the non-interconnected islands PPC announced that it was 27 GWh greater than the one of 2009 (PPC, 2011). Basic statistical analysis led the electricity production dataset to its final form. In Figure 1 the total electricity production – divided in thermal and RES-E - is shown, classified to 3 groups, namely Crete, Rhodes and the rest of the islands.

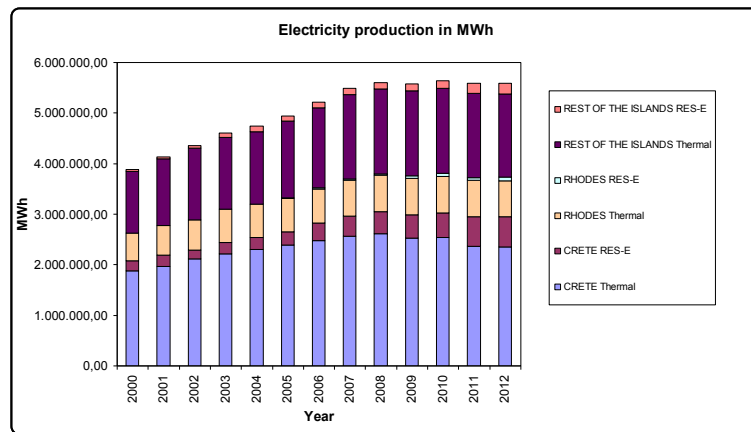

Figure 1. Electricity production on the non-interconnected islands in the period 2000-2012

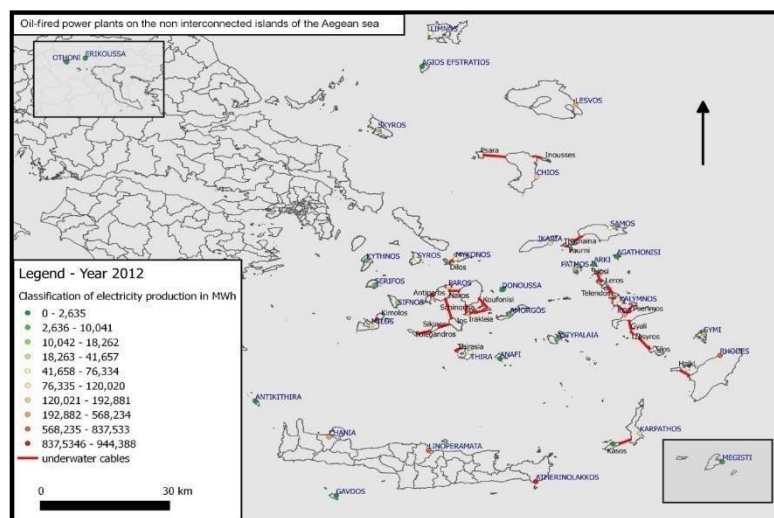

Figure 2. 2012's thermal electricity production on the non-interconnected islands

2.2. CO₂ emissions

The one and only data source as regards the actual CO₂ emissions from the combustion of oil in the TPPs of the non-interconnected islands is the annual verified emissions for the period 2005-2012 of the 19 of them that participate in the European Commission's ETS (EC, 2013). Additionally the National Emissions Inventories – data availability until 2012²⁷ - and more specifically the data given in the *1.A.1.a Energy Industries – Public electricity and Heat Production (Liquid Fuels)* category of the Table 1.A(a) *SECTORAL BACKGROUND DATA FOR ENERGY* constitute (MEECC, 2013) a tool for the cross-checking of the estimations.

In order to bring the final CO₂ emissions dataset in the form of annual and monthly CO₂ emissions per TPP in the period 2000-2012, the following actions took place:

²⁷ The National Inventory Reports are published every 2 years in April, covering the data until 2 years ago. That is the reason why the examined period of the present study restricted to the years 2000 to 2012 and not 2013; although the electricity production database is updated until 2013. For comparing reasons wherever possible data about 2013 are given.

- (a) Estimations of annual and monthly distribution of CO₂ emissions from all TPPs in the period 2000-2004; it must be noticed that the TPPs are not 35 in 2000. For example Atherinolakkos's TPP in Crete started to produce in 2004.
- (b) Monthly distribution of the annual verified CO₂ emissions of the 19 TPPs that participate in EU-ETS. These are: Atherinolakkos, Chania and Linoperamata (Crete), Rhodes' TPP and the TPPs on the following 15 islands: Chios, Ikaria, Kalymnos, Karpathos, Kos, Lesvos, Limnos, Milos, Mykonos, Paros, Patmos, Samos, Sifnos Syros and Thira.
- (c) Estimations of annual and monthly distribution of CO₂ emissions for the TPPs that do not participate in EU-ETS for the period 2005-2012.

In the cases (a) and (c) above, the emissions have been calculated using the following equation (RAE, 2004), which is the one that the country uses to prepare its National Emissions Inventories:

$$E_{CO_2} = \sum_f FC_f * NCV_f * CC_f * OX_f * 44/12 \quad (1)$$

where, E_{CO_2} is CO₂ emissions in t, f is an index referring to the fuel consumed, FC_f is the consumption of fuel- f in kt, NCV_f is the net calorific value of fuel- f in TJ/kt, CC_f is the carbon content in the fuel- f in tC/TJ and OX_f is the oxidation factor of fuel- f in %. The fraction 44/12 represents the molecular weight ratio of CO₂ to carbon.

Except of the consumed fuel that must be estimated, all other parameters for diesel oil and heavy fuel oil used by the TPPs on the islands are given in the National Inventories Reports (RAE, 2004) for the period 2000-2012.

TPPs are distinguished to those that use diesel oil exclusively and those that use diesel and heavy fuel oil. The TPPs that have been using diesel oil for the whole study period are the following 20 plus Chania TPP in Crete: Agathonisi, Agios Efstratios, Amorgos, Anafi, Antikithira, Arki, Astypalaia, Donoussa, Erikoussa, Gavdos, Karpathos, Kythnos, Megisti, Mykonos, Othoni, Patmos, Serifos, Sifnos, Skyros and Symi. These 20 TPPs represent an average of 4.65% of the total electricity production for the period 2000-2012. Taking into consideration the TPP Chania in Crete the aforementioned average becomes 22.83%. The rest 14 TPPs (2 in Crete, 1 in Rhodes included) use both types of fuels in a non-standard ratio every year. In general heavy fuel oil consumption is far greater than the diesel oil one. The only year, for which fuel data per type (diesel and heavy oil), month and TPP are available, is 2008. For years 2000-2001 monthly fuel quantities are available for the TPPs except for those in Crete and Rhodes. Consequentially there are known shares of each type of fuel consumed per TPP for years 2000, 2001 and 2008. Specifically for Crete and Rhodes the electricity production data from PPC (2000-2009) are given per installed unit; therefore there is information about the percentages of electricity produced per fuel type.

Indirect information regarding the annual redistribution (due to decommissioning of old units, installation of new ones, transfer etc.) of the units on the islands are to be found in the Regulatory Authority for Energy (RAE, 2008b) (IPCC, 2006a) and the already mentioned data obtained from PPC for 2012 and 2013 (estimation). In any case these data can not be used to formulate a clear view for the shares in the existing units per fuel and island; this occurs because such data do not exist every year and do not represent possible last minute actions from PPC in order to cover exceptional needs. Though these data can be used as a draft cross-check for the estimations of the fuel shares that are needed to apply eq.(1) in order to calculate the CO₂ emissions; the estimations refer to the periods 2002-2007 and 2009-2012, for which no fuel quantities are known.

Except of the TPPs of Crete and Rhodes (4 in total) the analysis of 3-years (2000, 2001 and 2008) known shares of each fuel type in the TPPs of 11 islands (Chios, Ikaria, Kalymnos, Kos, Lesvos, Limnos, Milos, Paros, Samos, Syros and Thira) has led to the following categorization: (a) islands with TPPs of diesel fuel share that increases linearly and becomes 100% (Milos in 2008, Ikaria in 2009), (b) islands with TPPs of diesel oil share that increases/decreases linearly until a certain year and then stabilizes (Chios/Limnos/Thira and Paros with diesel shares of 2.4% and 1.3% respectively since 2008) and (c) islands with TPPs of diesel fuel share that increases linearly (Lesvos, Samos and Syros) or decreases linearly (Kalymnos, Kos) for the whole period 2000-2012. Dispersion diagrams (years on x-axis, diesel % share on y-axis) have been derived for each island and trend lines have been applied to complete the missing years (2002-2007, 2009-2012) shares of diesel. The results for the diesel fuel shares have been draft cross-checked with the aforementioned data at the level of unit, discarding extreme cases e.g. a relative big diesel fuel share appears where no diesel generator exists or the opposite.

The existing differentiations in fuels/units, data form and availability has led to different approaches as regards the estimation of the fuel quantities and the calculation of the CO₂ emissions according to eq.(1).

In order to check the estimations for the period 2000-2004 also taking into consideration the national totals, included in the *I.A.I.a Energy Industries – Public electricity and Heat Production (Liquid Fuels)* category of the

Table 1.A(a) *SECTORAL BACKGROUND DATA FOR ENERGY* MEECC, 2013), the parameter of tCO₂/MWh has been used. More specifically using the electricity production data (by liquid fuels) for the whole country and the equivalent CO₂ emissions from the national inventories, the parameter of tCO₂/MWh has been calculated for the years 2000-2004. Subtracting the equivalent for the non-interconnected islands (productions / emissions estimations) from these 2 data groups (productions / emissions) a pair of values remains annually, from which the parameter of tCO₂/MWh is annually calculated. Figure 3 shows the results of the comparison.

According to *2006 IPCC Guidelines for National Greenhouse Gas Inventories* (IPCC, 2006b) and more specifically the *Generalized decision tree for estimating emissions from fuel combustion* (IPCC, 2005) the above described approach could be classified as a Tier 2 method; given that country-specific emission factors for different fuels are available ($CC_f * OX_f * 44/12$ part of eq.(1)).

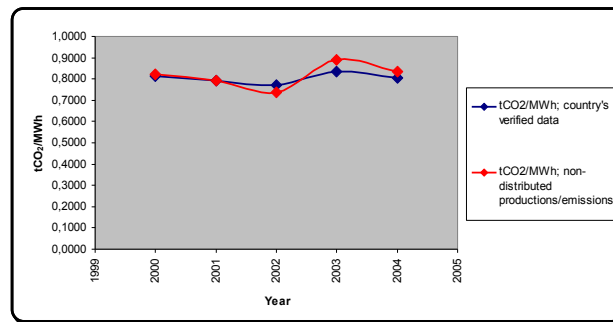

Figure 3. Comparison of the parameter tCO₂/MWh – verified country's totals / non-distributed productions/emissions

The yearly contribution of the CO₂ emissions – verified and estimated – from the TPPs on the non-interconnected islands to the national total of the specific category – *Public Electricity and Heat Production Sector (by liquid fuels)* - is shown in Figure 4. The penetration of natural gas in mainland's electricity grid justifies the decrease in the national totals, seen on the graph since 2009, while in 2011 and 2012, 94.3% and 92.6% respectively of the CO₂ emissions of the specific category comes from the oil combustion in the TPPs on the non-interconnected islands.

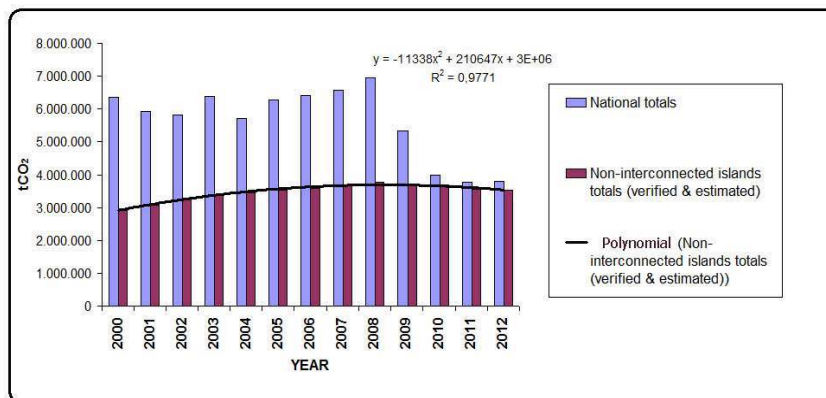

Figure 4. Contribution of CO₂ emissions (verified and estimated) from the TPPs on the non-interconnected islands to the national totals in the period 2000-2012

2.2.1. Trend assessment

32 of the 35 annual CO₂ emissions time series increase. 2 of the 3 that decrease are these from the TPPs of Linoperamata and Chania in Crete. Despite the decrease in the 2 TPPs the total of the CO₂ emissions in Crete in absolute values increased in 2012 by 14.16% compared to 2000.

The SLOPE function, S_f , that estimates the direction and steepness of the regression line has been applied for all of them.

$$S_f = \frac{\sum (x - \bar{x})(y - \bar{y})}{\sum (x - \bar{x})^2} \quad (2)$$

3. GIS platform creation, learning targets, results

3.1. GIS platform creation

To achieve the first learning target – namely to work with GIS software for CO₂ emissions visualization – the following minimum number of layers (*shp* files) is required:

- existing background layer representing the current administrative divisions of Greece (entitled *final_kallikratis.shp*); the layer's Attribute Table includes population data per administrative division according to census 2011 (HSA, 2013b); the islands' population can also be found there;
- the connections between islands by underwater cables (entitled *underwater cables.shp*);
- the allocation of the TPPs (entitled *final-ASP-MWh.shp*); the annual electricity production of the 35 TPPs for the period 2000-2012 constitutes the Attribute Table of the specific layer;
- 2 layers that both contain the allocation of the TPPs and their Attribute Tables are the annual and the monthly CO₂ emissions time series, respectively (entitled *final-ASP-tCO2.shp* & *final-ASP-tCO2monthly.shp*) as estimated;
- finally one more layer is included, namely the one needed to restrict the kriging results within the islands' surfaces and not above the sea or across the Greek mainland (entitled *final_grid.shp*).

All required layers (*shp* files) along with basic guidance for the educator can be downloaded from <http://users.sch.gr/barkass/>. The GIS platform, from which figures and maps are derived, has been created in both ArcGIS and QGIS software. The 2nd one is a free and open source program. In the aforementioned website the basic guidance for the educator is oriented to the usage of *QGIS 2.6.1 Brighton* software. All screenshots shown in the figures are taken from ArcGIS except of the map in Figure 2 that has been created in QGIS. In Figure 7 a part of the visual kriging results in QGIS is seen at the left of the main map, that is created by ArcGIS. Briefly the production of a map/image - like the ones shown in Figures 7 to 12 - includes the following 3 steps²⁸:

1. selection of a specific year's or month's CO₂ emissions (layer *final-ASP-tCO₂* or *final-ASP-tCO₂monthly*) and application of the kriging method, which exports the visualization in black and white;
2. colorization of the kriging results using a color ramp (like the one seen in Figure 7) and an amount of classes (e.g. 10) for the visual classification of the emissions' range of values;
3. finally the restriction of the CO₂ emissions visualization above the islands using the appropriate tool (*extract by mask* in case of ArcGIS and *Clip grid with polygon* in case of QGIS); the aforementioned *final_grid* layer plays the role of the mask/polygon.

In Figure 6 the results are shown after the completion of the 2nd step. The 3rd step along with basic settings (e.g. legend, title etc.) remains in order to bring the CO₂ emissions mapping in a final map form as shown in Figure 7. It is proposed to use the same colour ramp (see Figure 7) in all maps for comparison reasons. Additionally it is more convenient to save the CO₂ visualization results (of every desired phase and zoom) as images and gather them in another application (e.g. Excel) to proceed to the final learning targets – namely the discussion and the drawing of conclusions.

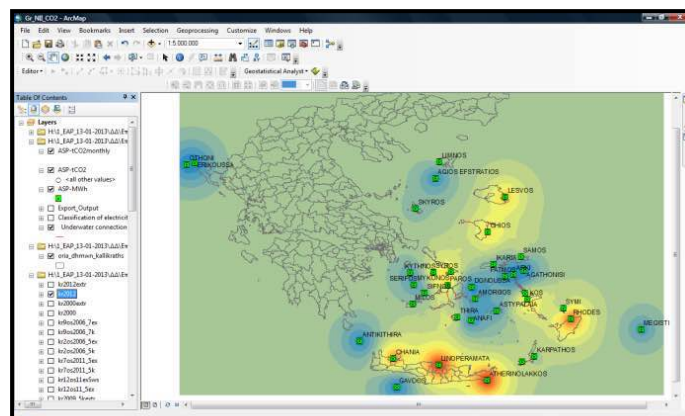

Figure 6. Kriging's visual results after the extract in a raster file

²⁸ Download the file *Further_guidance.doc* from <http://users.sch.gr/barkass/> for more detailed guidance.

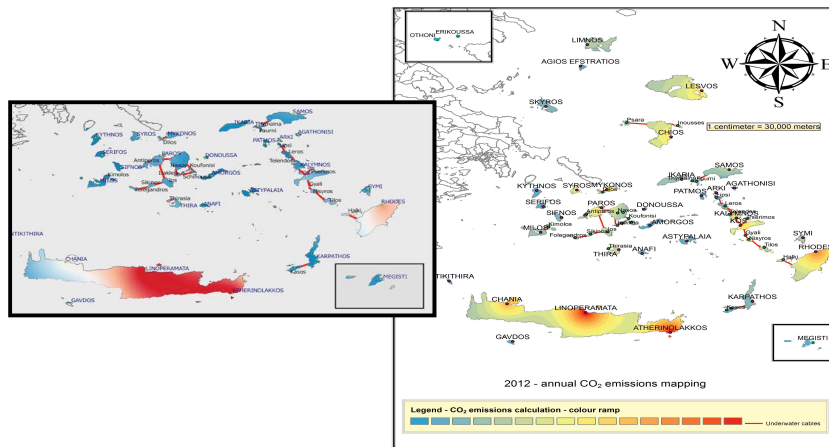

Figure 7. CO₂ emissions mapping for 2012 (ArcGIS & QGIS)

3.2. Learning targets – indicative guidance and results

Regarding the time needed to achieve the following learning targets at least a time interval of 2 3-hours classes is proposed².

As regards the class framework, it could be a computer laboratory (with 12 computers; that is the case in Greece's school labs) where the students could work in pairs while the resulted figures/maps (in easy to handle picture formats) could be collected in one computer for the final comparison/discussion.

The educational targets of the present study are to guide the students to be able:

- to work with user-friendly GIS software on a computer laboratory for CO₂ emissions visualization so that to realize the extent of the emitted CO₂ in the atmosphere from oil combustion for the electrification of isolated regions, in this case the Greek Aegean non-interconnected islands; former knowledge in GIS software is not required for the students;
- to draw conclusions from what they create; namely the colored visualized CO₂ emissions maps/images. Therefore it is the educator's task to propose directions as regards the selection of specific years/months. To this direction the theoretical knowledge along with parts of the background analysis of section 2 provides the educator with useful information to support the interpretation of the resulted maps;
- to develop a creative skepticism regarding issues that directly or indirectly influence the environment: combustion of oil for electricity production and the resulted CO₂ concentration increase in the atmosphere, dependence of the security of supply of electricity from imported fuels, targeted development (e.g. tourism's increase) and corresponding increase of electricity demand etc.

3.2.1. Proposed directions

The simplest choice, with which the educator can start, is the creation and comparison of annual CO₂ emission maps. These are enough to visualize the fact that the emissions steadily increase in the majority of the islands.

As regards the monthly CO₂ emission maps and the more detailed observation on specific islands (by zooming in) it is proposed to make selections that represent "extreme" cases; for example the zooming in could focus on the biggest consumers among the islands (Crete and Rhodes) and the selection of the months as well as the comparison could be the one focusing either on months in the "heart" of winter that indicate high demand due to heating purposes or months in the high touristic period for the same reason.

3.2.2. Indicative results

Figures 8, 9 & 10: by comparing the annual CO₂ emission maps the general conclusion is that the emissions steadily increase. Despite the fact that Crete has the biggest RES-E share (see Figure 1) and that the Chania TPP steadily reduces its CO₂ emissions, those of the island steadily increase (Figure 8). Rhodes's year by year increase in CO₂ emissions seems clearer on the maps ((Figure 9).

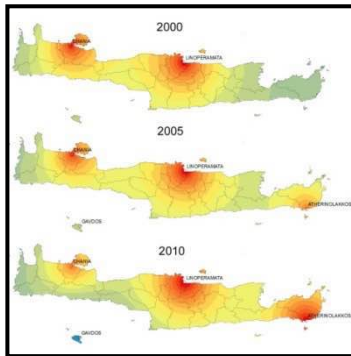

Figure 8. Spatially interpolated CO₂ emissions in Crete for years 2000, 2005 and 2010

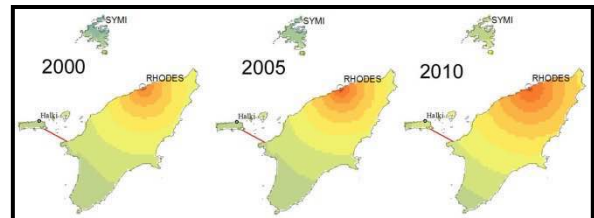

Figure 9. Spatially interpolated CO₂ emissions in Rhodes for years 2000, 2005 and 2010

Figures 11, 12: the comparison of monthly CO₂ emission maps shows that diachronically increased emissions are to be seen in summer months; see Figure 11 for such a comparison between January and August 2001 in the so called Paronaxia islands complex (Paros, Naxos, Antiparos, Ios etc.) and Figure 12 for a comparison between December and July 2011 on the same islands complex plus Syros and Mykonos islands. The selected years with a decade difference (2001-2011) prove that the increased summer emissions do not change over the years despite the fact that the RES-E penetration generally increased. By choosing to compare less electricity demanding months, e.g. at the end of the winter/touristic period, is the only case where emissions decreases might also appear. Differentiations regarding the exact month that the decreases appear might indicate a longer lasting touristic period.

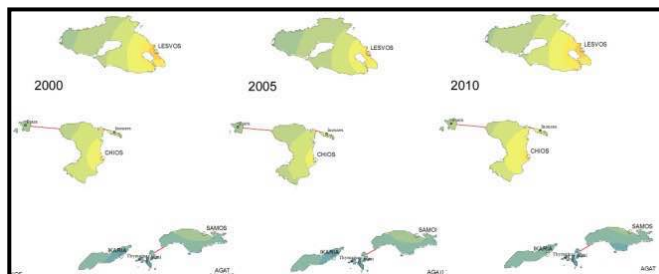

Figure 10. Spatially interpolated CO₂ emissions on Northern Aegean islands for years 2000, 2005 and 2010

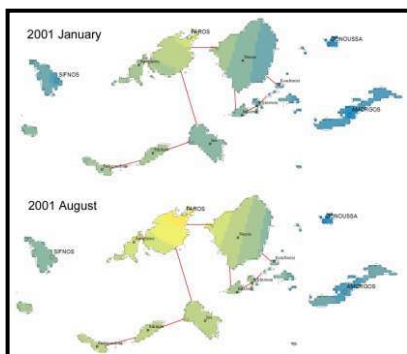

Figure 11. Spatially interpolated CO₂ emissions on Cyclades islands for January and August 2001

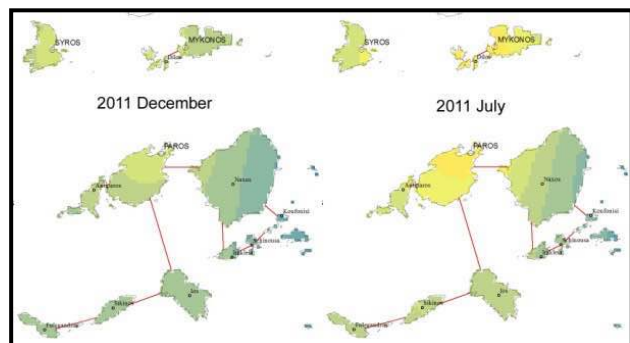

Figure 12. Spatially interpolated CO₂ emissions on Cyclades islands for December and July 2011

4. Conclusions - discussion

The educator that will use the material and the proposed methodology to deal with learning issues like islands' electrical systems and their particularities, CO₂ emissions from oil combustion, CO₂ emissions mapping etc. should for the total of the class hours be focus on the final learning target by proposing adequate directions (see paragraph 3.2.1.) that would easily guide to the desired problematic for discussion. It is important to remind the students in every single step of the process that (for example) darker reds in the resulted maps/images represent more burning oil.

Assuming that the specific material and methodology could be exploited (for example) in a course of natural resources exploitation/exhaustion the next class could focus on the estimated potentials of renewable “fuels” in the Aegean Sea. Maps of wind or solar potentials of the region could be compared with the CO₂ visualization results. Assuming that darker colors would represent in both cases higher values, their comparison would “supply” the educator with further interesting issues for discussion, like for example costs of choices (oil import or creation of offshore wind parks).

As regards the study's choice to support a GIS-based platform – simultaneously targeting to an increase of the environmental awareness of the students (Bodzin A., Anastasio D., 2006) - it is useful to set and answer the following question:

Why is GIS useful instead of simple tables of data?

- (a) The emphasis on spatial thinking (that devices of daily use - like mobile phones, GPS in cars etc. – in a way “promote”) establish a new background “knowledge” (or just familiarization) basis, which can be exploited by the educator in order to achieve specific learning targets.
- (b) GIS in conjunction with extra material – like for example the electricity production data in the present study – can make the work easier and more attractive for the students, despite the big amounts of data (Bodzin A., Anastasio D., 2006).
- (c) Working with GIS gives both educators and students the chance to project a specific practice on another similar framework (Bodzin A., Anastasio D., 2006). In this study the non-interconnected islands of the Aegean Sea was the case. These are not the unique case of non-interconnected electricity markets in the Mediterranean Sea or elsewhere. Notice that at present in Greece and other countries of the Mediterranean the extraction of oil and natural gas stands very high in the political agenda.
- (d) Indirectly the geographical approach of the electricity needs coverage can also designate important interdisciplinary connections as between targeted development (tourism increase) and environmental impacts (UNEP, 2013). Such connections could lead to a creative skepticism regarding the kind of targeted development.
- (e) Lastly but not less important the high participation grad of students in the specific learning framework is consistent with the basic principles of environmental education.

References

Bodzin A., Anastasio D., 2006, *Using Web-based GIS For Earth and Environmental Systems Education*, Journal of Geoscience Education, 54(3):295.

European Commission, 2013a, *Union Registry*, available at: http://ec.europa.eu/clima/policies/ets/registry/documentation_en.htm

European Environment Agency, 2013, *EMEP/EEA air pollutant emission inventory guidebook – 2013, Chapter 7 spatial mapping of emissions*, available at: <http://www.eea.europa.eu/publications/emep-eea-guidebook-2013>

Hellenic Statistical Authority, 2013a, *Resident population – Census 2011*, (in Greek) available at: http://www.statistics.gr/portal/page/portal/ESYE/BUCKET/General/resident_population_census2011.xls

Hellenic Statistical Authority, 2013b, Press Release, (in Greek) available at: http://www.statistics.gr/portal/page/portal/ESYE/BUCKET/General/nws_SAM01_GR.PDF

IPCC, 2006a, *Guidelines for National Greenhouse Gas Inventories*, available at: <http://www.ipcc-nggip.iges.or.jp/public/2006gl/vol2.html>

IPCC, 2006b, *Guidelines for National Greenhouse Gas Inventories*, Volume 2 Energy, Chapter 1: *Introduction*, Paragraph 1.3.1.2, page 1.9, available at: http://www.ipcc-nggip.iges.or.jp/public/2006gl/pdf/2_Volume2/V2_1_Ch1_Introduction.pdf

IPCC, first published 2005, *IPCC Special Report on Carbon Dioxide Capture and Storage*, available at: http://www.ipcc.ch/pdf/special-reports/srccs/srccs_chapter2.pdf

- Karamanou E., Papathanassiou S., Papadopoulos M., 2009, *Planning the Interconnection of Islands to the Mainland Grid via Submarine Cables*, National Technical University of Athens supported by the Regulatory Authority for Energy of Greece, available at: http://s3.amazonaws.com/zanran_storage/users.ntua.gr/ContentPages/558882713.pdf
- Kasselouri B., Kambezidis H., Konidari P., Zevgolis D., 2011, *Environmental, economic and social aspects of the electrification on the non-interconnected islands of the Aegean Sea*, Energy Procedia, Volume 6, pages 477-486
- Kerski J., Demirci A., Milson A., 2013, *The Global Landscape of GIS in Secondary Education*, Journal of Geography, 112:6, pages 232-247, DOI: 10.1080/00221341.2013.801506
- Ministry of Environment, Energy and Climate Change, 2011, *Study on Crete's electrical system development, interconnection with mainland grid*, (in Greek) available at: <http://www.ypeka.gr/LinkClick.aspx?fileticket=vFPxYoCvpwo%3D&tabid=367&language=el-GR>
- Ministry of Environment, Energy and Climate Change, 2013, *Emissions Inventory – Annual Inventory submission of Greece under the Convention and the Kyoto Protocol for Greenhouse and other Gases for the years 2000-2012*, available at: http://unfccc.int/national_reports/annex_i_ghg_inventories/national_inventories_submissions/items/7383.php
- National Technical University of Athens, 2008, Final report on *Strategic Study of the islands interconnections*, (in Greek) available at: http://www.rae.gr/site/file/categories_new/about_rae/activity/research/report9?p=files&i=0
- Public Power Corporation SA, 2009, *Greek Islands: Electric Energy, Networks, Connections and Smart Grids*, presentation by Prof. Nikos Hatziargyriou Vice Chair and Deputy CEO-PPC during the Conference on RES & ENERGY SAVINGS IN ISLANDS, 23-25 Oct. 2009, Milos, available at: http://www.aegean-energy.gr/pdf/milos-conf2009/GR_Islands_Electric_Energy_Networks_Connections_and_Smart_Grids.pdf
- Public Power Corporation SA, 2011, *2010 financial results*, (in Greek) available at: <http://finance.in.gr/Article.aspx?articleID=38788>
- Public Power Corporation SA, 2013, *Generalized monthly reports of thermal and RES-E production on the non-interconnected islands*, (in Greek) available at: <http://www.dei.gr/Default.aspx?id=10845&nt=19&lang=1>
- Regulatory Authority for Energy, 2004, *Electricity production units on the non-interconnected islands except of Crete and Rhodes*, (in Greek) available at: <http://www.google.gr/url?sa=t&rct=j&q=&esrc=s&source=web&cd=1&ved=0CC8QFjAA&url=http%3A%2F%2Fwww.rae.gr%2FK1%2FTR-PPC.xls&ei=M49aUoa3KIXMgaQ8YGoAw&usq=AFQjCNEIxnSL8S-TMB5H5DgblgnWEDLNw&bvm=bv.53899372,d.Yms&cad=rja>
- Regulatory Authority for Energy, 2008a, *Decision 588 Mean variable production cost of PPC on the non-interconnected islands*, (in Greek) available at: <http://www.rae.gr/old/K2/islvarcost2008.pdf>
- Regulatory Authority for Energy, 2008b, *Appendix – Thermal units on operation*, (in Greek) available at: http://www.rae.gr/old/K1/DEH_T1a.pdf
- Regulatory Authority for Energy, 2009, *Decision 1802 Mean variable production cost of PPC on the non-interconnected islands*, (in Greek) available at: <http://www.rae.gr/old/K2/islvarcost2009.pdf>
- Regulatory Authority for Energy, 2011, *Decision 736 Mean variable production cost of PPC on the non-interconnected islands*, (in Greek) available at: <http://static.diavgeia.gov.gr/doc/4%CE%91%CE%A3%CE%95%CE%99%CE%94%CE%9E-%CE%97%CE%9B3>
- Regulatory Authority for Energy, 2012, *Decision 435 Mean variable production cost of PPC on the non-interconnected islands*, (in Greek) available at: <http://static.diavgeia.gov.gr/doc/%CE%92414%CE%99%CE%94%CE%9E-%CE%92%CE%A71>
- Tomohiro Oda, Shamil Maksyutov, 2009, *Two global maps of anthropogenic CO₂ emission derived using database of large point source*, Center for Global Environmental Research, National Institute for Environmental Studies, presentation during 18th Annual International Emission Inventory Conference "Comprehensive Inventories -Leveraging Technology and Resources", Baltimore – Maryland, available at: www.epa.gov/ttnchie1/conference/ei18/session7/oda.pdf
- Tsioliariidou E., Bakos G.C., Stadler M., 2006, *A new energy planning methodology for the penetration of renewable energy technologies in electricity sector—application for the island of Crete*, Energy Policy 34, pages 3757-3764
- U.S. Energy Information Administration, *Europe Brent Spot Price FOB*, available at: <http://www.eia.gov/dnav/pet/hist/LeafHandler.ashx?n=PET&s=RBRTE&f=A>
- United Nations Environment Programme, 2013, *Tourism's Three Main Impact Areas*, available at: <http://www.unep.org/resourceefficiency/business/tourism/factsandfiguresabouttourism/impacts/tourism/threemainimpactareas/tabid/78776/default.aspx>
- Washington & Jefferson Coll., 2009, *A Method for Implementing a Statistically Significant Number of Data Classes in the Jenks Algorithm*, FSKD 6th International Conference on Fuzzy Systems and Knowledge Discovery, Volume 1, available at:

http://ieeexplore.ieee.org/xpl/articleDetails.jsp?tp=&arnumber=5358673&url=http%3A%2F%2Fieeexplore.ieee.org%2Fexpls%2Fabs_all.jsp%3Farnumber%3D5358673

Affiliation and address information

Kasselouri Barbara – PhD Candidate
Hellenic Open University – School of Applied Arts
Panos & Skiathou
Nea Makri, 19005, Athens, Greece,
E-mail: bar_kass@yahoo.gr

Physics Teachers' Inventions Fair – Conference and Source of Teaching Ideas

Zdeňka Koupilová, Leoš Dvořák

Department of Physics Education, Faculty of Mathematics and Physics, Charles University in Prague

Abstract

The Physics Teachers' Inventions Fair is an annual conference of Czech physics teachers of all levels where they share ideas how to make lessons more attractive. Papers from the conference are a very good source of teaching ideas. To offer these ideas to people who did not attend the specific conference, we built the searchable database of selected papers, which is freely accessible for public. The very best papers were translated into English. The paper describes the conference and the database.

Keywords

Secondary education: lower and upper and University education; Teachers (teacher training, professional development...), teaching ideas, simple experiments, database

1. The conference – the Physics Teachers' Inventions Fair

The Physics Teachers' Inventions Fair is an annual conference of Czech physics teachers of all levels – from basic school teachers to university professors. They share ideas namely about new demonstration and laboratory experiments, but also about long-term projects and experience on how to make their lessons more attractive. There are about 100-150 participants and more than 40 papers presented each year. The tradition of the conference goes back to 1996 when the first conference took place in Prague. Even though the impact of the conference is mostly national, every year there are more than ten participants from foreign countries, so the exchange of ideas is not limited to Czech Republic.

2. Database of selected papers

Papers from the conference are a very good source of teaching ideas because they are mostly ready to be used in classrooms. To offer these ideas to people who did not attend the specific conference we built the database of selected papers which is publicly accessible.



Figure 1. Demonstration of experiments and teacher audience observing an experiment demonstration

The development of the summary proceedings started in 2002 and at the occasion of the 10th conference in 2005 the first version was presented – on CD and online as well. According to the number of accesses to the online version of the summary proceedings and the survey of opinions of the conference attendants done in 2008, the database was considered to be a very useful and often used source of ideas for physics teachers of all levels of schools. That is why the papers from further conferences have been gradually added. In 2012, the collection of all summary proceedings was implemented into a database. To enable effective search, information about level, topic, equipment demands and keywords were added to all papers.

Up to now, all 18 years of the conference are covered (from the period 1997 – 2013). Not all papers presented in the conference and published in individual proceedings are in the database. Apart from quality of the papers, our selection criteria demand that the papers have to be oriented on experiments, especially on the experiments with simple equipment and easily accessible equipment, or present ideas how to make learning more attractive and active. Most papers are in Czech, several of them in Slovak or English. It is possible to search the papers not only according to their titles or author names, but also according to their topics. An extensive structured index is implemented here as well. Besides of papers, the pdf files with the complete proceedings, photos and reports from individual Fairs and 13 extended papers written specially for the database supplement the database content.

At the beginning of 2013 we started to use Google Analytics to monitor web visitors. From the preliminary data we can conclude that users are mostly teachers and students because there is the lowest visit rate on Fridays and Saturdays (and Czech bank holidays) and a systematic decrease during July – but even during summer holidays there are still about 50 unique visits per day. Despite most visitors come from public web search engines like Google, there are about 20 % of returning visitors. Because of the language aspect it is not a surprising fact that 80 % of the visitors are Czech and 15 % are Slovak.



Figure 2. Numbers of unique visitors per day

3. English version of the database

Because we wanted to present the conference internationally, several best papers were translated into English. A positive feedback from the international community led us to the decision to transform the list of English versions of the papers into a form more comfortable for the readers. Therefore, a separate database of English versions of the papers was built and offers the same possibilities as the original Czech version. The database is fully searchable, enables to find papers according to keywords etc. Also, more papers were translated into English, now there are about 80 papers.

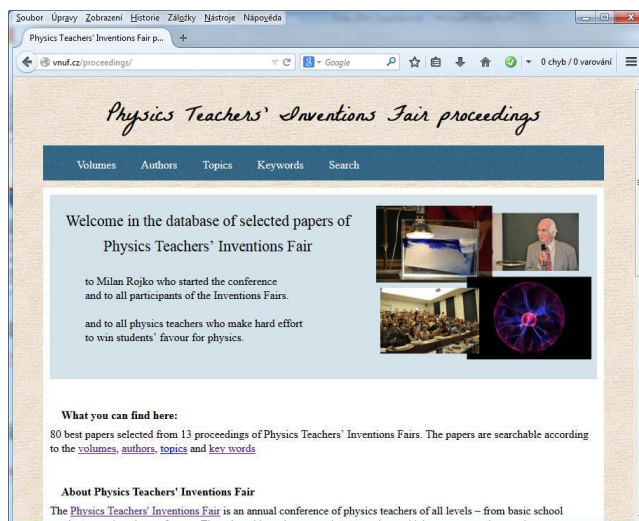

Figure 3. Homepage of the English version of the database of selected papers.

References

Database of selected papers of Physics Teachers' Inventions Fair, in English: <http://vnuf.cz/proceedings/>

Database of selected contributions: Inventions Fair for Physics Education, in Czech

<http://vnuf.cz/sbornik/>

Home page of the conference Physics Teachers' Inventions Fair: <http://vnuf.cz/index-en.html>

Selected papers of Physics Teachers' Inventions Fair in English: <http://vnuf.cz/papers/>

Affiliation and address information

Zdeňka Koupilová

Department of Physics Education

Faculty of Mathematics and Physics, Charles University

V Holešovičkách 2

180 00 Prague 8, Czech Republic

e-mail: zdenka.koupilova@mff.cuni.cz

High School Students' Misconceptions in Electricity and Magnetism and some Experiments that can Help Students to Reduce Them

Vera Koudelkova, Leos Dvorak

Charles University in Prague, Faculty of Mathematics and Physics, Department of Physics Education

Abstract

The Czech Conceptual test from the area of Electricity and Magnetism was prepared at Department of Physics Education, Faculty of Mathematics and Physics, Charles University in Prague. First part of the paper presents three problematic topics which were identified using this test – charge distribution on an insulators, Coulomb's law and electromagnetic induction. However, to identify misconceptions is not enough. Therefore, the main part of the paper presents some experiments which can help students to overcome their misconceptions and to better understand not only the topics mentioned above. Most of these experiments can be done with very simple tools and materials.

Keywords

Electricity and Magnetism, misconceptions, experiments, high school

1. Introduction

Electricity and magnetism is one of topics in the Czech curriculum for high school physics. It is natural to explore how Czech high school students (students of age from 15 to 19) understand Electricity and Magnetism and which misconceptions are typical for them. For this, we prepared the Conceptual test from the area of Electricity and Magnetism. The test, examples of questions and results were presented on ICPE-EPEC 2013 conference and are published in its Proceedings (Koudelkova, Dvorak, 2014). Therefore, only basic information about this test is written in the first part of this paper. Further, in the main part of the paper, we present some experiments, which could help students to overcome their misconceptions. Important information about concrete students' misconceptions are also presented since they are relevant for experiments that should help to overcome them.

2. About CCTEM

Czech Conceptual Test from the area of Electricity and Magnetism (CCTEM) is based on CSEM (Maloney, 2001). It has 18 questions, nine of them are used from CSEM (seven of them being slightly modified), other nine correspond to Czech curriculum.

Nearly 200 students were involved in the testing of the final version of CCTEM during school year 2012-2013, more than 150 others were involved during school year 2013-2014. All involved students (aged 16-18) are from general high schools. The pretest was done just before beginning of the lessons from the area of electricity and magnetism, the post-test just after the instruction. Students usually had lessons from the area of electricity and magnetism for about half a school year, two lessons (45 minutes each) a week. (The range partly depends on the school curriculum.)

More detailed information about the test and its developing was written in the paper (Koudelkova, Dvorak, 2014).

3. Example of results and experiments

Note: Experiments described below were prepared on the basis of results of CCTEM in the school year 2012-2013.

3.1 Charge distribution on insulators

There are two questions in the test focusing on charge distribution – one is about charge distribution on a conductor, the second one concerns charge distribution on an insulator. The assignment is similar in both questions – what will happen with small amount of charge, which we put on one place at a can/PET bottle. Possible answers are following:

- A. All of the charge remains near the point
- B. The charge is distributed over the outside surface of the tin/bottle
- C. The charge is distributed over the outside and inside surface of the tin/bottle
- D. Most of the charge is still near the point, but part of it is distributed over the surface of the tin/bottle
- E. There will be no charge left

In the question concerning a can, results were not bad (more than 40 % of students in post-test chose the correct answer). Concerning the charge distribution on a bottle, only 18 % of students in the post-test chose the correct answer. Students seem to be convinced that charge disappears and it seems that this misconception survives after the instruction (almost 80% of students have this idea before the instruction and still almost 70% after the instruction, see fig. 1).

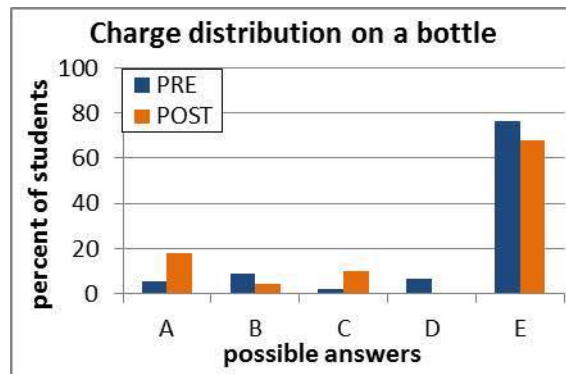

Figure 1. Charge distribution on a plastic bottle – students answers

Czech students have experience with charge distribution on a can – we often use cans for electrostatics experiments. On the other side, they know the charge distribution on an insulator only from a case of plastic rod, so they, in fact, have no experience with charge distribution on an insulator. For a better understanding of charge distribution on an insulator we use a model of a “plastic can” – as a suitable model we found sewage pipe, which looks similar as a can, is non-conducting, is not antistatic and it’s big enough (bigger pipe is necessary to show students that it is possible to charge it only at one place).

As a charge indicator we use a piece of aluminium fastened on a piece of wire.

Arrangement of the experiment can be seen in figure 2.

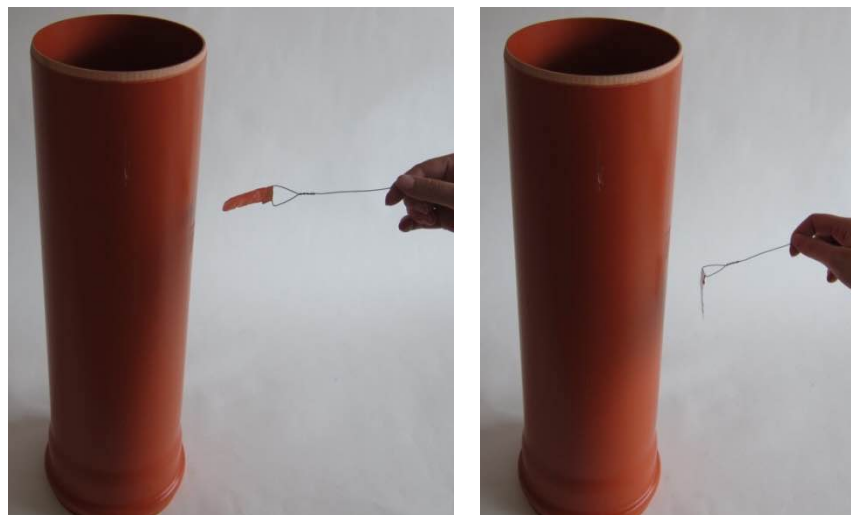

Figure 2. Arrangement of the experiment – charged place on sewage pipe (left) and place without charge (right)

Using this sewage pipe, students can see differences between behaviour of charge on a conductor and on an insulator:

Charge on a pipe stays only at the place we charged. If we put charge on several places, it will be on each of them.

If we discharge one place from those charged before, charge will remain on the other places. Charge stays on the tube for more than few minutes, it doesn't disappear.

One technical note: Charge stays on the pipe for a long time, so it is problem to discharge it. One suitable method is wiping the pipe by wet cloth and then letting it to dry.

3.2 Coulomb's law

Students learn Coulomb's law for quite a long time and they usually solve many tasks including quantitative tasks. However, it seems they don't understand Coulomb's law as well as one could expect after the time they spent learning it.

In the test, there are two questions which focus on Coulomb's law. In the first of them, we ask students how the electric force acting on a given charge will change when we put charge $3Q$ instead of charge Q to the same distance. Results of this question are good both in pretest and post-test – there are about 75% of correct answers.

In the second question we ask students how the electric force will change when we put one of two charges two times further.

Students' results can be seen in fig. 3. Possible answers are:

- A. $F_e/4$
- B. $F_e/2$
- C. F_e
- D. $4F_e$
- E. another possibility

It can be seen, that more than 60% of students (both in pretest and post-test) chose answer B. So, they thought, that the force will be one half.

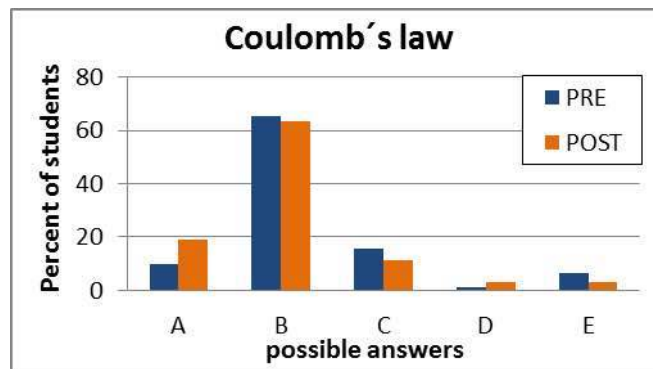

Figure 3. Coulomb's law – students answers

Reason for this result can be that students know Coulomb's law well, but only quantitatively. So, is it possible to show them the dependence of electric force on distance qualitatively and more illustratively?

We use two experiments which can show students this dependence qualitatively. First of them is used in our Interactive Physics Laboratory (see Šabatka et al., 2014). It uses two ping-pong balls covered by conductive colour as a charges. The force is measured using sensitive scales. Arrangement of this experiment can be seen in fig. 4. Students can use this setup for both qualitative experiments and quantitative measurement.



Figure 4. Demonstration of Coulomb's law using ping-pong balls (Sabatka et al., 2012)

For the second experiment one needs only very low-cost equipment – a straw, a piece of paper, a skewer and a pin.

The skewer with a pin is used as a stand for the straw. A scale is drawn on a piece of paper. The whole setup is placed on the end of a table (far from any metal parts).

It can be easily seen that the deflection of the straw is proportional to the repelling (Coulomb) force. The deflection can be seen on the upper part of the straw, which is used as a pointer. The lower part of the straw (close to its end) is charged. If we make the distance between the charged rod and the straw twice smaller, we can see that the deflection is approximately four times larger. In the left situation in the figure 5, the distance between charged rod and a lower part of a straw is about 60 cm and the deflection is about one centimetre. In the right-hand side part of the figure, the distance is half size (about 30 cm) and the deflection is four centimetres.

It is possible to use this experiment to find proportionality constant in the Coulombs' law, but this measurement is only very approximate.

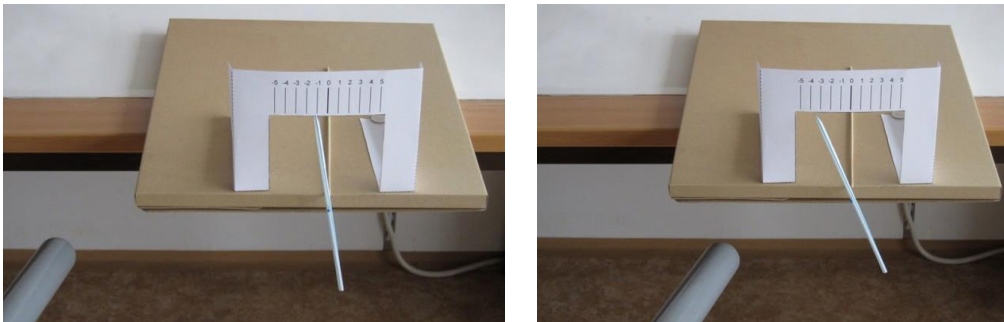

Figure 5. Coulombs' law – a simple qualitative experiment

3.3 Electromagnetic induction

There is one question in the CCTEM test focused on electromagnetic induction. Students are asked in which mutual movements of a magnet and a loop with ammeter will be any current measured by the ammeter. Students choose different options from these movements: movement of the magnet from the loop; collapsing of the loop (which change the area of the loop); rotation of the loop around its axis; movement of the loop toward to the magnet. All possibilities can be seen in fig. 6.

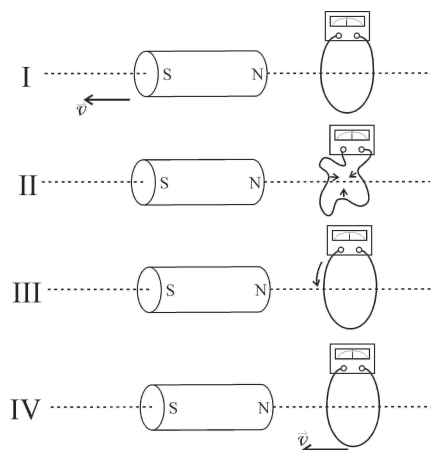

Figure 6. Electromagnetic induction – assignment of the task

This question is based on a similar question from CSEM. Authors of CSEM mentioned, that 72% of students "...who choose answers that used the idea that "motion" from either the loop or the magnet is necessary to create an induced current. Students may not seem the collapsing loop as changing the magnetic flux or the

rotating loops as not changing the magnetic flux.” (see Maloney et al., 2001, p. S18). It seems that Czech students are more “careful” and chose only possibilities they know for sure. About 35 % of students chose answer which corresponds with movement of the loop toward to the magnet; other nearly 30% of students chose answer which corresponds with movement of the magnet to the loop or the loop to the magnet. Only about 15% of students chose correct answer in the post-test (and about 10% in the pretest).

So, students seem to know that the voltage is induced when there is some movement between the magnet and the loop. Some of them maybe know the Faraday’s law and know something about change of magnetic flux, but they seem to have problem to understand fully what a “change of magnetic flux” means. Also, they don’t see that changing the area of the coil changes the flux.

Now, how to show them what is the area of the coil and what connection is between changes of the area of the coil and induced voltage?

As a “magnet” we use uniform magnetic field of thin neodymium magnets forming a plate, a coil is made from pliable wire and the induced voltage is measured by a voltmeter.

The overall setup can be seen in figure 7.

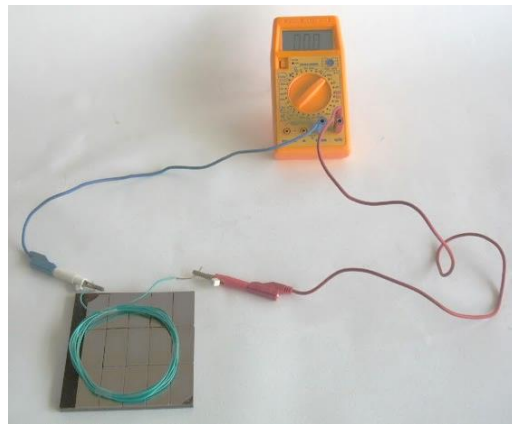

Figure 7. A coil in an uniform magnetic field

Using this equipment, we can show students that the voltage is induced when:

We deform the coil (which changes the area of the coil)

We move the coil to or from the magnets (if we are far enough from the magnets where the field is not uniform)

We move the coil outside the surface of the magnets (which changes the area in which magnetic lines intersects the coil)

We rotate the coil around its horizontal axis (which changes the angle between the coil and the direction of magnetic field lines).

Also, we can show them in which situation the voltage is *not* induced:

There is no movement of the coil with respect to the magnet (so, there is some magnetic flux, but it doesn’t change)

We rotate the coil around its vertical axis (again, there is no change of magnetic flux)

We deform the coil with the core inside it (nearly all magnetic field is inside the core, so the important “area” is the area of the core and the magnetic flux stays practically constant).

4. Conclusion

The CCTEM was intended primarily as a diagnostic tool for Czech high school teachers. Therefore, it is only in Czech now. However, if you are interested in it, English version could be provided too.

Experiments we describe above are simple and mostly low-cost. However, they show effects students seem to have problem with, so they can help students to overcome their misconceptions. Verification of the influence of these experiments on students’ comprehension of this area is in progress.

References

Koudelkova, V., Dvorak, L. (2014). High schools students' misconceptions in electricity and magnetism and how to diagnose them. *ICPE-EPEC 2013 Conference Proceedings*. Prague 2014. ISBN 978-80-7378-266-5. p. 898-905.

Available on: http://icpe2013.org/uploads/ICPE-EPEC_2013_ConferenceProceedings.pdf

D. P. Maloney, T. L. O'Kuma, C. J. Hieggelke and A. Van Heuvelen (2001). Surveying students' conceptual knowledge of electricity and magnetism. *Am. J. Phys.* **69**, 12-23

Z. Sabatka, Z. Drozd, V. Koudelkova (2014). Interactive Physics Laboratory and Collection of Demonstration Experiments. *Proceedings of the World Conference on Physics Education 2012*. ISBN 978-605-364-658-7. p.1135-1141. Available on: <http://www.wcpe2012.org/proceedings.html>.

Affiliation and address information

Vera Koudelkova

Charles University in Prague

Faculty of Mathematics and Physics

Department of Physics Education

V Holešovičkách 2

180 00 Prague 8

Czech Republic

e-mail: vera.koudelkova@mff.cuni.cz

Kinematics Concepts at Different Representation Levels – a Mutual Information Approach

Clemens Wagner, Andreas Lichtenberger, Andreas Vaterlaus

Solid State Physics and Education, ETH Zurich, Otto-Stern-Weg 1, 8093 Zürich

Abstract

We introduce mutual information in order to analyse correlations between the knowledge of different concepts in kinematics at Swiss high schools. The multiple-choice test we have developed to study these correlations contains items at different representation levels. We distinguish between questions with images, tables and diagrams. The analysis revealed that the kinematics concepts group due to their mathematical background. Thus we find high mutual information between the rate concept of velocity and acceleration. The same was found for the vector property of velocity and acceleration in one dimension. Moreover, high mutual information was obtained between items related to image and table representations. This observation might be due to similar solution strategies, which have to be applied to solve these problems.

Keywords

Physics Concepts, Representation Level, Factor-Analysis, Mutual Information

1. Introduction

Kinematics is one of the initial topics of the physics curriculum taught at Swiss high schools. Investigations using the force concept inventory (FCI) have shown that conceptual knowledge is often missing after teaching. In order to analyse the students' conceptual knowledge in Kinematics we developed a multiple-choice test, which items can be distinguished not only at the conceptual level but also at the three different level of representation. Questions at the first level are associated with images, like stroboscopic pictures. At the second level, questions are furnished with tables and at the third representation level motion of objects are represented by diagrams. Some of the questions could be posed at all three levels others only at two different levels of representation.

In our study 56 students from different classes of Swiss high schools were exposed to the test. We first used exploratory factor analysis to figure out what concepts load on the same factor. The analysis revealed a surprising relationship: Concepts with the same mathematical background group together and not, as expected physics concepts like velocity or acceleration. This emphasizes the importance of mathematical knowledge in physics and is in line with the work of Planinic (Planinic, Ivanjek, Susac, & Milin-Sipus, 2013) and Bassok (Bassok & Holyoak, 1989). Factor analysis revealed in total four different factors and since two of them are explained by mathematical concepts, two factors remained to be clarified. Thus, the goal of this paper is twofold first, to corroborate the results from factor analysis by a different method and second, to find an explanation for the other two factors.

As a new method we used mutual information to detect correlations among different quantities (Cover & Thomas, 1991). With this approach we reanalysed our data set in order to corroborate the results obtained by factor analysis. Moreover, we suggest that the two additional factors are due to different solution strategies applied by the students.

2. Data Acquisition

We collected the data from two teachers who teach at two different High Schools in Switzerland. Overall 56 students (30 female, 26 male) participated in this pilot study at the average age of 16 ± 1 years. One teacher taught two classes with 38 students and the class of the other teacher contained 18 students. The distribution of students among the major subjects was: 12 (Languages), 11 (Mathematics and Physics), 3 (Biology and Chemistry) and 30 (Economics). However, the students with major Mathematics and Physics had no additional Physics lessons during the teaching period.

Kinematics was taught for about 6 weeks with three lessons a week. The teaching material of both teachers was collected in order to have control about the content of each lesson.

We applied our multiple-choice test of kinematic concept questions to the students at the end of the instruction phase. The order of items was the same for all students and the items had to be solved sequentially (no item could be skipped). The test consists of 56 questions and the average time to finish the test was (46 ± 8) min.

3. Test Design

The test is described in Lichtenberger et al. (Lichtenberger, Vaterlaus, & Wagner, 2013) and based on seven concepts in Kinematics, which are given in Table 1.

Table 1: The seven concepts of Kinematics, which form the basis of the multiple-choice test. In this work we omit concepts 4 and 7 since they were not explicitly taught.

Number	Concept
1	Velocity as rate.
2	Velocity as a one-dimensional vector (forward, backward).
3	Velocity as a two dimensional vector.
4	Omitted (distance covered as area under the velocity-time curve)
5	Acceleration as rate
6	Acceleration as one-dimensional vector (speeding up, slowing down)
7	Omitted (velocity change as area under the acceleration-time curve)

For these concepts we developed multiple-choice questions at three representation levels. The different levels are defined as images, tables and diagrams (see **Errore. L'origine riferimento non è stata trovata.**). The diagram- and the table-questions were easy to identify and all other MC-questions were furnished with images.

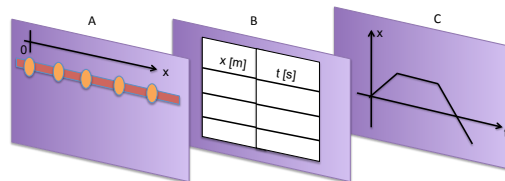

Figure 1: Three levels of representation: (A) Images, (B) Tables and (C) Diagrams.

An overview of the item distribution among concepts and representation levels is displayed in **Errore. L'origine riferimento non è stata trovata.**

Table 2: Item overview. For concept 1 there are 3, 2 and 5 MC-questions at representation level A, B and C, respectively. In total we analysed 27 problems, whereof 12 are images, 3 tables and 12 diagrams.

	Level A Images	Level B Tables	Level C Diagrams	Total
C1	3	2	5	10
C2	2	-	2	4
C3	3	-	-	3
C5	2	1	4	7
C6	2	-	1	3
	12	3	12	27

Three representative questions are given in the Appendix.

4. Results from Factor Analysis

Here we give a brief summary of the results we have got from factor analysis (see Table 3). Due to the five concepts under investigation (Table 1) we expected to obtain five factors. In this case all questions associated with concept 1 would group in one factor and so on. However, what we observed was completely different.

The data could be explained by four factors, which were not directly related to the concepts mentioned in Table 1.

Concepts 1 and 5 group together, on the one hand for images and tables and on the other hand for diagrams. The same holds for concepts 2 and 6. Since concepts 1 and 5 are linked with the concept of rate and concepts 2 and 6 with the concept of a vector we concluded that the mathematical concepts are important for the students. Thus the question remained, why do these mathematical concepts split due to the representation levels.

Table 3: Results of the exploratory factor analysis. Items related to the rate concept (velocity C1 and acceleration C5) load on factor one and three and items related to the one-dimensional direction property of the velocity and the acceleration (C2 and C6) load on factor two and four. Factors one and two are associated with representation level A and B problems whereas factors three and four are related to questions furnished with diagrams (level C). The first column represents the question identifier. Questions 7, 35 and 36 are not properly assigned by factor analysis.

	Level A & B		Level C		
	Factor 1	Factor 2	Factor 3	Factor 4	
2	.779				Rate (C1, C5) Images, Tables
4	.682			.201	
5	.992				
11	.596				
12	.274	-.272	.347	-.207	
51	.697				
53	.706				
54	.591				
6					
7		.374			1d Direction (C2, C6) Images, Tables
13		.184	.345	.325	
14		.692	-.223		
35		.691			
36		.402	.237		Rate (C1, C5) Diagrams
38		.672	.367		
40		.259	.719		
39			.916		
42		.202	.275		1d Direction (C2, C6) Diagrams
44				.298	
				.997	
		-.261	.459	.465	

5. Mutual Information

Although factor analysis is a well-established method to find correlations within data we wanted to confirm the results using a different tool. Our approach to corroborate the above findings was to use mutual information.

Mutual information between two random variables A and B, $I(A,B)$, is defined as the uncertainty of variable A, $H(A)$, minus the uncertainty of A if B is known, $H(A|B)$. The mathematical expression of mutual information reads

$$I(A,B) = H(A) - H(A|B)$$

It is obvious that the mutual information is zero if B is not related to A (A and B are independent) and it is equal to the uncertainty of A if B contains the same information as A. In our case the random variable A is the probability that a student solves m out of n problems correctly regarding the same concept. We can calculate the same kind of probability for a second concept, which provides random variable B. In order to compute the mutual information between two concepts we are using the formula containing the joint probability for random variables A and B

$$I(A,B) = H(A) + H(B) - H(A,B)$$

where $H(A)$ and $H(B)$ represent the entropy of A and B, respectively, and $H(A,B)$ is the joint entropy of the random variables A and B.

The uncertainties of variables A and B are calculated using the standard entropy formulas

$$H(A) = -\sum_i p_{i,A} \log(p_{i,A})$$

$$H(B) = -\sum_j p_{j,B} \log(p_{j,B})$$

$$H(A,B) = -\sum_{i,j} p_{ij,AB} \log(p_{ij,AB})$$

As an example we show in Figure 2 the histogram of concept 1 for all 10 questions and the histogram of concept 5 for all 7 problems. The entropies can then be computed from the histograms. Let's assume that A represents concept 1 in the equations above. Then the entropy of concept 1 reads

$$H(\text{concept}_1) = -\sum_i p_{i,\text{concept}_1} \cdot \log(p_{i,\text{concept}_1})$$

i
(number
of
correct
answers)

Thus, the term with $i = 8$ contributes to the entropy

$$\dots - \frac{11}{56} \log\left(\frac{11}{56}\right) - \dots,$$

since there are 11 of 56 students with 8 correct answers out of 10 concept 1 questions.

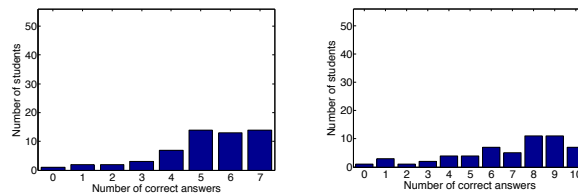

Figure 2: Histogram of students with respect to the number of correct solved problems concerning concept 5 (left panel) and concept 1 (right panel).

The joint probability distribution $H(A,B)$ is calculated from the histogram, which shows the distribution of students who solved $m_1 (\leq n_1)$ concept 1 questions correctly and $m_2 (\leq n_2)$ concept 5 questions, where n_1 and n_2 are the total number of concepts 1 and 5 questions, respectively (see **Errore. L'origine riferimento non è stata trovata.**).

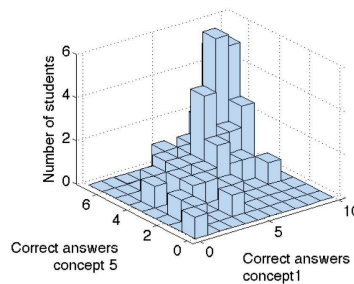

Figure 3: Histogram of students who solved (m_1, m_2) number of problems for concept 1 and 5 correctly.

In order to compare the relationship of the mutual information between different concepts we have to normalize it due to the different number of questions for a concept. The normalization we have chosen is the squared entropy correlation coefficient (ECC) (Cahill, 2010)

$$ECC^2 = \frac{2I(A,B)}{H(A)+H(B)}$$

It normalizes mutual information to values between zero and one. Considering the results of the factor analysis we expect a high value for the entropy correlation coefficients squared between concepts 1 and 5 and between concepts 2 and 6, whereas all other correlations should be small.

6. Results from Mutual Information Analysis

We have applied the mutual information approach to data collected from a multiple-choice test, which was devised to assess the student knowledge about Kinematics concepts (see **Errore. L'origine riferimento non è stata trovata.**). The test was administered to 56 students from two different high schools in Switzerland. We have determined the entropy correlation coefficients between different concepts for level A (images) and level C (Diagrams) problems. The results are shown in **Errore. L'origine riferimento non è stata trovata.**

Table 4: Squared entropy correlation coefficient between concepts for level A (images) problems.

Level A	Concept 1	Concept 2	Concept 3	Concept 5	Concept 6
Concept 1		0.04	0.11	0.14	0.11
Concept 2			0.11	0.16	0.13
Concept 3				0.06	0.06
Concept 5					0.006

The analysis mainly confirms the correlations based on the factor analysis. There are relative high correlations between concept 1 and 5 and between concept 2 and 6. However, the highest correlation occurs between concepts 2 and 5. Since this correlation has not been observed in factor analysis it might be due to a nonlinear relationship. The advantage of mutual information analysis is that it detects not only linear correlations but also nonlinear ones. To show this we compared the histograms between concept 1 and 3 and between 1 and 5 with entropy correlation coefficient squared of 0.11 and 0.14, respectively (see **Errore. L'origine riferimento non è stata trovata.**). The histogram of concept 1 and 3 clearly shows an n-shape profile referring to a nonlinear relationship whereas in the histogram of concept 1 and 5 the data points are distributed around the diagonal referring to a linear relationship.

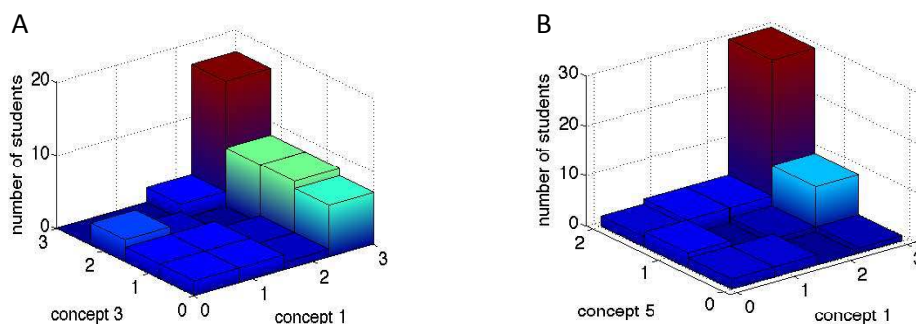

Figure 4: Histograms of student distributions to calculate the ECC^2 between concept 1 and 3 (A; $ECC^2 = 0.11$) and concepts 1 and 5 (B; $ECC^2 = 0.14$).

It remains to explain, why the ECC between concept 2 and 5 is rather high ($ECC^2 = 0.16$), which could not be expected from factor analysis. The questions linked to the concepts are items 6 and 7 (concept 2) and items 11 and 12 (concept 5). The item difficulties range between 0.77 and 0.84 referring to simple problems since more than 75% of the students were able to solve these items. This can lead to a nonlinear distribution in the histogram and might be the reason for high ECC value. Inspecting factor analysis (see **Errore. L'origine riferimento non è stata trovata.**) we observe that already there the items 7 and 12 cannot be properly assigned by the algorithm.

We conducted the same analysis also for level C (diagrams) problems (see **Errore. L'origine riferimento non è stata trovata.**). However, concepts 3 and 6 are omitted since they are covered either by zero or one item. Again, concepts 1 and 5 are highly correlated. Moreover, concept 2 and 5 (which are correlated for images and tables) are almost uncorrelated when using questions with diagrams.

Table 5: Squared entropy correlation coefficient between concepts for level C (diagrams) problems.

Level C	Concept 1	Concept 2	Concept 5
Concept 1		0.10	0.27
Concept 2			0.07

Finally, we were interested in analysing the relationships between different representations of the same concept. We just consider concept 1 since it is the only concept having at least 2 items per representation. The results for the ECC, displayed in **Errore. L'origine riferimento non è stata trovata.**, show that indeed representations at level A and B are strongly correlated, whereas there is almost negligible correlations found between levels A and B and level C.

Table 6: Squared entropy correlation coefficient between different levels of representation (A: images; B: tables; C: diagrams) for concept 1.

Concept 1	level A	level B	level C
level A		0.43	0.11
level B			0.06

7. Discussion

We have used a mutual information approach in order to study correlations between concepts and representation levels in kinematics. Mutual information between two concepts tells us how much information students can transfer from one concept to the other. Thus, high mutual information between concept 1 and concept 2 means, that knowing concept 2 is quite helpful to solve problems concerning concept 1 (the uncertainty about concept 1 is significantly reduced by knowing concept 2) and vice versa (mutual information and ECC are symmetric). We have found high correlations between concepts 1 and 5 and between concepts 2 and 6. Since concepts 1 and 5 share the same mathematical background (velocity as rate and acceleration as rate) we assume that the mathematical concept of rate is more important to solve these problems than the physical concepts of velocity and acceleration. The same conclusion also holds for concepts 2 and 6 (velocity as 1d vector and acceleration as 1d vector). If these results are transferred to teaching it means that clear instructions about the mathematical background (rate and 1d vectors) before teaching physics concepts might be of advantage for the students in order to solve these problems.

If we study the correlations between different representation levels of a single concept we have found the following results. Considering concept 1, problems with representation levels image and table strongly correlate. In contrast, multiple-choice questions using diagrams are almost uncorrelated to problems with images and tables. In order to explain these findings we had a closer look at the problems. Some of the questions with images use stroboscopic pictures. The velocity in these problems has to be estimated by the ratio of the difference of two subsequent positions (distance covered) divided by the difference between two subsequent time points. We can also consider image questions without a stroboscopic picture like example 1 in the appendix. Also for this problem the solution strategy would be to draw the velocity for two different time points and then divide the difference between the velocities by the elapsed time in order to get the acceleration. The very same strategy also works for tables, where the velocity (acceleration) is assessed by the ratio of the differences of two subsequent entries. This can be easily seen solving example 2 in the appendix. The velocities of body 2 (constant) and body 1 (accelerated) have to be estimated by the ratio of two subsequent entries. Thus, we conclude that problems with images and tables have a common solution strategy. In contrast, solving items with diagrams the velocity is estimated by the slope of the tangent, which requires a quite different approach. Considering example 3 (diagram) in the appendix where one has to decide whether an object is moving forward or backward. Although it is not a concept 1 question the solution can be easily derived from the slope of the tangent. Thus we believe that the concepts 1, 2, 5 and 6 at the representation levels images, tables and diagrams can be divided into four groups using the mathematical concepts of rate and 1d vector and the solution strategy of the ratio of differences (images and tables) and the

slope of the tangent (diagrams). These results are summarized in **Errore. L'origine riferimento non è stata trovata.**

Table 7: Matrix representation of item categorization. The physical concepts (**Errore. L'origine riferimento non è stata trovata.**) with representation levels A, B and C (**Errore. L'origine riferimento non è stata trovata.**) can be newly grouped into mathematical concepts and solution strategies. The separation into different solution strategies has only been shown for concept 1 problems.

	mathematical concept: rate	mathematical concept : 1d vector
solution strategy: ratio of differences	concept 1 concept 5 images tables	concept 2 concept 6 images tables
solution strategy: slope of tangent	concept 1 concept 5 diagrams	concept 2 concept 6 diagrams

From this work we conclude that mutual information is a valuable, complementary tool to factor analysis. On the one hand mutual information analysis corroborates factor analysis since it also detects linear relationships. On the other hand it helps to find inconsistencies of a test when linear correlations are low but nonlinear correlations high.

References

- Bassok, M., & Holyoak, K. J. (1989). Interdomain Transfer between Isomorphic Topics in Algebra and Physics. *Journal of Experimental Psychology-Learning Memory and Cognition*, **15**, 153-166.
- Cahill, N. D. (2010). Normalized Measures of Mutual Information with General Definitions of Entropy for Multimodal Image Registration. In Fischer B., Dawant B. and Lorenz C. (Eds.), *Biomedical Image Registration, Lecture Notes in Computer Science 6204* (pp. 258-268). Berlin Heidelberg: Springer-Verlag.
- Cover, T. M., & Thomas, J. A. (1991). *Elements of Information Theory*. New York: John Wiley & Sons.
- Lichtenberger, A., Vaterlaus, A., & Wagner, C. (2013). Analysis of Student Concept Knowledge in Kinematics. *Proceedings of the ESERA 2013 conference in Nicosia, Cyprus*, Strand 11.
- Planinic, M., Ivanjek, L., Susac, A., & Milin-Sipus, Z. (2013). Comparison of university students' understanding of graphs in different contexts. *Physical Review Special Topics-Physics Education Research*, **9**, 020103.

Affiliation and address information

Clemens Wagner

Solid State Physics and Education
Department of Physics, ETH Zurich
Otto-Stern Weg 1
8093 Zürich
Switzerland
e-mail: wagnercl@phys.ethz.ch

Andreas Lichtenberger

Solid State Physics and Education
Department of Physics, ETH Zurich
Otto-Stern Weg 1
8093 Zürich
Switzerland
e-mail: lichtenberger@phys.ethz.ch

Andreas Vaterlaus

Solid State Physics and Education
Department of Physics, ETH Zurich
Otto-Stern Weg 1
8093 Zürich

Switzerland
e-mail: vaterlau@phys.ethz.ch

Appendix

Example 1: Item 8 (Level A, concept C6: acceleration as vector)

A helicopter is approaching for a landing. It moves vertically downwards and reduces its velocity.



Which of the following statements describes the acceleration of the helicopter best?

1. The acceleration is zero.
2. The acceleration points downwards.
3. The acceleration points upwards.
4. The direction of the acceleration is not defined
5. The acceleration has no direction.

Example 2: Item 51 (Level B, concept C1: velocity as rate)

Two bodies are moving on a straight line. The positions of the bodies at successive 0.2-second time intervals are represented in the table below.

Time in s	0.0	0.2	0.4	0.6	0.8	1.0	1.2	1.4
Body 1: Position in m	0.2	0.4	0.7	1.1	1.6	2.2	2.9	3.7
Body 2: Position in m	0.0	0.4	0.8	1.2	1.6	2.0	2.4	2.8

Do the bodies ever have the same speed?

1. No.
2. Yes, at the instants $t = 0.2$ s and $t = 0.8$ s.
3. Yes, at the instants $t = 0.2$ s.
4. Yes, at the instants $t = 0.8$ s.
5. Yes, at some time between $t = 0.4$ s and $t = 0.6$ s.

Example 3: Item 28 (Level C, concept C2: velocity as vector)

The following represents a position-time graph (x - t -diagram) for an object.

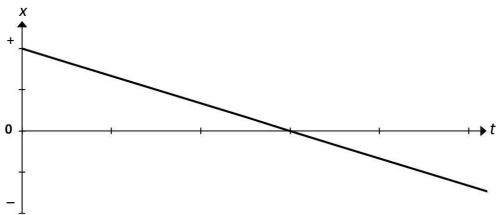

Which of these describes the motion best?

1. The object always moves forward.
2. The object always moves backward.
3. The object moves forward at first. Then it moves backward.
4. The object moves down an inclined plane.

Guiding Students to Combine Partial Laws of Energy Conservation

Paul S. W. M. Logman¹, Wolter H. Kaper², Ton L. Ellermeijer³

¹ *VU University Amsterdam*

² *University of Amsterdam*

³ *Centre for Microcomputer Applications*

Abstract

The concept of the general law of energy conservation is a difficult concept for students to grasp. To improve the versatility of their conceptions of energy we have chosen to implement a guided reinvention approach. The teaching-learning sequence that we have developed is subdivided into three distinct stages: reinventing partial laws from measurements, combining those partial laws into one combined law, and extrapolating that combination procedure to arrive at the general law of energy conservation. In this paper we focus on the second stage of combining partial laws. More specifically, in view of the final stage of the teaching-learning sequence, we focus on the role that reflection plays in performing this task.

In the related assignments student pairs were asked to investigate whether already established partial laws of energy conservation could be combined and to perform the required combination procedure if possible. Before and after performing the procedure itself the students were asked to predict and reflect on which procedural steps they thought were necessary to successfully combine partial laws of energy conservation.

In students' worksheets we observed two types of spontaneous reflection: describing procedural steps generally while performing the combination procedure itself, and the other way around giving concrete examples for each step while predicting and reflecting on that procedure.

Most student pairs that were successful in the final combination showed one or both of these types of reflection and most student pairs that were not successful did not. Of the two types of reflection the first type of spontaneously adding abstract descriptions of each step alongside performing it was the most frequently observed and also the most effective type of reflection in order to perform the final combination procedure better. This observation may be used to make the second stage of our teaching-learning sequence more effective and, more broadly, may also be used to guide students in learning other complex procedures.

Keywords:

Energy, Guided reinvention, Conceptual development, Reflection

1. Introduction

The concept of energy conservation is an abstract concept which is difficult for students to apply to various situations (Borsboom et al., 2008; Liu et al., 2002) and to revise when necessary (Kaper, 1997). To improve the versatility of students' conceptions we have chosen a guided reinvention approach (Freudenthal, 1991). Freudenthal says that knowledge and ability, when acquired by one's own activity, stick better and are more readily available than when imposed by others. We think that having students reinvent the general law of energy conservation will make their conception of it more revisable as well.

Historically the energy concept has grown from establishing partial laws (e.g. Huygens' conservation of vis viva for elastic collisions (Hugenii, 1728)) and combine those when necessary. Joule described many of such combined laws (Joule et al., 1884a). Because he knew about all these combinations he was already convinced before he performed his famous experiment (Joule, 1850) that there should be a fixed relation between mechanical energy and heat and thus that a combined quantity is conserved.

We have chosen to bring our students to a similar conviction. The conceptual development in our teaching-learning sequence is subdivided into three distinct stages which mimic the historical discovery. Each of the six given assignments contributes to one or more of the three conceptual learning stages. In the first stage students need to reinvent what we call partial laws of energy conservation. This is mostly done in the first three assignments. In the second stage the students need to learn how to combine the partial laws of energy

conservation in such a way that the resulting law covers a larger domain. This is done in the last three assignments. In the case of energy conservation one may never be sure that this results in a final all-encompassing law of energy conservation because new uninvestigated terms may still need to be added to the law. Because of this the students need to reflect on the process of combining partial laws to investigate whether such a combination is always possible. This is done during the final assignment. If students during this process reflection come to the conclusion that an expansion of the law is always possible when necessary they will have effectively reinvented the general law of energy conservation (Logman et al., 2012).

We have developed the required teaching-learning sequence for sixteen- or seventeen-year-old students by testing it in three cycles in several schools which is common to design research (Van den Akker et al., 2006). The first stage of reinventing partial laws has been the focus of earlier papers (Logman et al., 2010, 2011). In this paper we will focus on the second stage which takes place during the last three assignments. In this second stage of combining partial laws the students are asked to investigate whether it is possible to combine the earlier established partial laws of energy conservation and if so to perform the required combination procedure. According to Lijnse & Klaassen (2004) more general concepts may be abstracted by reflection on the learning process. In view of this and the final stage of the teaching-learning sequence (in which reflection plays a major part) we will focus on the role that reflection plays in the second stage of combining partial laws.

The more specific research question for this paper therefore is the following: “Which role does reflection play in guiding students to combine partial laws of energy conservation?”

2. Educational design

The first of the three stages in which we have subdivided our teaching-learning sequence to guide students to reinvent the general law of energy conservation is to reinvent what we call partial laws of energy conservation (e.g. $\sum mh = k_1$). In three consecutive technological design assignments students are intended to reinvent three of such partial laws (see Figure 5).

In the second stage students are given scientific assignments in which they are asked to investigate whether it is possible to combine pairs of partial laws of energy conservation (e.g. combining $\sum mh = k_1$ with $\sum mcT = k_2$ where we expected students to arrive at $\sum mh + 426 \cdot \sum mcT = k_3$). Using two of such combination procedures all three partial laws that were reinvented in the first stage can be combined into one law (again see Figure 5). Although the resulting law (containing gravitational, thermal, and kinetic energy) is a more general law of energy conservation it still remains just a partial law of energy conservation because other terms containing uninvestigated variables may need to be added.

Because the resulting law is still just a partial law of energy conservation a third stage is needed to reinvent the general law of energy conservation. In this third stage students are asked in a scientific assignment to investigate whether it is possible to expand the law whenever in an experiment a new variable shows its influence. In this stage the students need to evaluate whether all the process steps that are necessary to reinvent and combine a new partial law into the already established law, are always possible to perform. If in this process reflection the student concludes that these steps are indeed always possible the law now has become applicable to any situation: the general law of energy conservation is reinvented.

An overview of the three stages in the teaching-learning sequence is given in Figure 5.

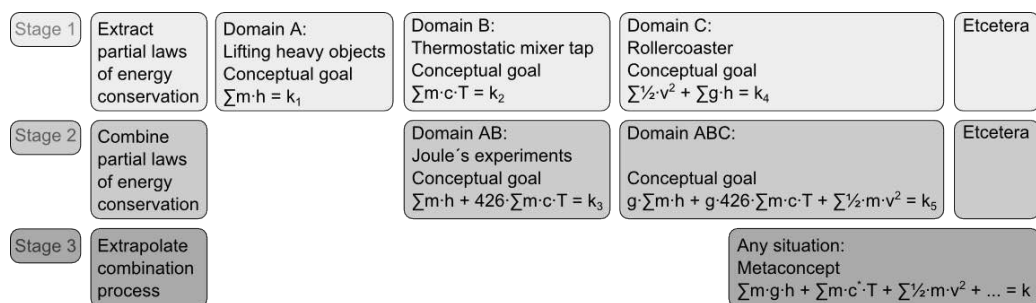

Figure 5. Intended learning trajectory towards reinventing the general law of energy conservation¹

¹ The equation at the bottom right is meant to describe the general law of energy conservation including any terms as yet unknown to the students.

As stated in the introduction this paper focuses on the second stage of combining partial laws and more specifically on the role that reflection plays in it.

In the second stage students are given several opportunities to show their reflection on the process. At the beginning of each of the three scientific assignments the students were given a worksheet in which they were asked which steps they thought were necessary to combine the partial laws of energy conservation at hand, based on their earlier experience. After being shown a demonstration of an experiment in a classroom discussion the students were shown how to perform the first combination procedure of partial laws. Subsequently they were asked to write down their own version of it in a scientific report to convince other scientists of the result. After the actual combination procedure the students were given a worksheet in which they were asked to reflect on which steps were necessary during the combination procedure and write these down. The second combination procedure was subdivided into similar tasks (see Table 8).

Table 8. Work phases for the last three scientific assignments

Task	Student activity
Prediction	Predict the procedural steps necessary to combine the given partial laws
Perform procedure	Proof the combination of partial laws in a scientific report
Reflection	Reflect on which procedural steps were necessary

During the third and final combination procedure very little guidance was given: the students were asked to establish a possible new quantity and predict a procedure to incorporate this new quantity into the already established law. Once they had done that, they were given a description and the table of results of a different but also appropriate fictional experiment connecting temperature and electric potential difference across a capacitor. The students were now asked to incorporate the relevant new term into the earlier established conservation law (without telling them it needs to contain electric potential difference). They were asked to perform this third combination procedure themselves and write a scientific report on it. A reflection afterwards was not required during this third assignment.

3. Method & Analysis

In our research the students worked in pairs. In total 35 pairs of sixteen- or seventeen-year-old students from three different schools participated. The sources of information used for the analysis of the learning process are the handed in worksheets and reports for the final three assignments.

To measure the success of student pairs in combining partial laws of energy conservation we categorized the student pairs as successful once they were capable of establishing the new term that needs to be added to the law: $\frac{1}{18}mcU^2$. Of course student pairs that continued onwards were counted as successful as well² (see Figure 6³). This requirement selects those student pairs that are capable of repeating the sequence of actions to expand the law ever further themselves.

Dit is eenvoudiger te schrijven als:
 $(mgh + \frac{1}{2}mv^2 + mcT + 0,056 \cdot mcU^2)_{begin} = (mgh + \frac{1}{2}mv^2 + mcT + 0,056 \cdot mcU^2)_{eind}$

Figure 6. This student pair identified the new term ($0.056 \cdot mcU^2$) and added it to the conservation law

Most other student pairs did not come up with the new term but ended their efforts to find a combination prematurely when they had only established the new partial law (see Figure 7).

² By using the values of m and t given in the fictional experiment connecting temperature and electric potential difference across a capacitor students could come up with the more familiar $\frac{1}{2}CU^2$ as well.

³ Translation: "This may be simplified as:
 $(mgh + \frac{1}{2}mv^2 + mcT + 0.056 \cdot mcU^2)_{begin} = (mgh + \frac{1}{2}mv^2 + mcT + 0.056 \cdot mcU^2)_{end}$ "

$$\frac{\Delta T}{\Delta V^2} = \text{constant} = 10,95 = \frac{15}{0,9}$$

Figure 7. This student pair ended their combination procedure after merely establishing the new partial law.

Student pairs that did not hand in enough data (in most cases this meant not handing in their scientific report) we remained undecided on.

To ascertain the role that reflection plays in successfully combining partial laws we also looked at the quality of students' answers to worksheets in which we asked them to predict or reflect on the steps that they thought were necessary to combine partial laws.

4. Results

Out of the 35 student pairs 16 were successful in establishing the correct term to add to the already established law in the final scientific assignment. The remaining 19 student pairs did not show explicitly that they were capable of doing so. Out of these 19 pairs 5 did not hand in their final scientific report.

While performing the derivation and combination procedure of partial laws a number of student pairs spontaneously added a description of the procedural steps. We call this *reflection type 1* (see Figure 8⁴).

Je hadde de 2 wetten:
 $-(\epsilon mc^2 T + \epsilon mgh)_{voor} = (\epsilon mc^2 T + \epsilon mgh)_{na}$
 $-(\epsilon V^2 + \epsilon 2gh)_{voor} = (\epsilon V^2 + \epsilon 2gh)_{na}$
 zoek naar gelijke termen: mgh & $2gh$ tot: — toevoegen
 $-(\epsilon mh2g + \epsilon mc^2 T2g)_{voor} = (\epsilon mh2g + \epsilon mc^2 T2g)_{na}$
 $-(\epsilon V^2 m + \epsilon 2gmh)_{voor} = (\epsilon V^2 m + \epsilon 2gmh)_{na}$
 op elkaar laten lijken tot:
 $(\epsilon mh2g + \epsilon mc^2 T2g + \epsilon V^2 m)_{voor} = (\epsilon mh2g + \epsilon mc^2 T2g + \epsilon V^2 m)_{na}$
 In Binas $c = 1 \cdot 9 \cdot 426$, dus alles :2 tot:
 $(\epsilon mgh + \epsilon mV^2 \frac{1}{2} + \epsilon cmT)_{voor} = (\epsilon mgh + \epsilon \frac{1}{2} mV^2 + \epsilon cmT)_{na}$

Figure 8. This student pair described two procedural steps more generally: looking for equal terms, and make the terms resemble each other

Later in the assignment series, when they were asked to describe the necessary procedural steps, student pairs illustrated these steps spontaneously with concrete examples of their earlier performed actions. We call this spontaneous behavior: *reflection type 2* (see Figure 9⁵).

⁴ Translation: "Earlier we had established the 2 laws:

$$-(\sum mc^2 T + \sum mgh)_{before} = (\sum mc^2 T + \sum mgh)_{after}$$

$$-(\sum v^2 + \sum 2gh)_{before} = (\sum v^2 + \sum 2gh)_{after}$$

Looking for equal terms: mgh & $2gh$ to (adding):

$$-(\sum mh2g + \sum mc^2 T2g)_{before} = (\sum mh2g + \sum mc^2 T2g)_{after}$$

$$-(\sum v^2 m + \sum 2gmh)_{before} = (\sum v^2 m + \sum 2gmh)_{after}$$

Enhance resemblance to:

$$-(\sum mh2g + \sum mc^2 T2g + \sum v^2 m)_{before} = (\sum mh2g + \sum mc^2 T2g + \sum v^2 m)_{after}$$

In scientific tables $c = 1 \cdot 9 \cdot 426$, so we divide everything by 2:

$$\left(\sum mgh + \sum mv^2 \frac{1}{2} + \sum cmT\right)_{before} = \left(\sum mgh + \sum \frac{1}{2} mv^2 + \sum cmT\right)_{after}$$

⁵ Translation: "After this it is possible to combine the discovered law with earlier laws. We have done the same in series 5 and it can be done as follows:

First of all we combine these two laws:

$$(m \cdot h)_{before} = (m \cdot h)_{after}$$

$$v_{before}^2 + (2 \cdot g \cdot h)_{before} = v_{after}^2 + (2 \cdot g \cdot h)_{after}$$

We can do so by multiplying everything by the mass m .

In such a way we arrive at the following law:

$$mv_{before}^2 + (2 \cdot g \cdot h \cdot m)_{before} = mv_{after}^2 + (2 \cdot g \cdot h \cdot m)_{after}$$

$$\text{Subsequently we combine this law with yet another law, } (m \cdot h + m \cdot c \cdot T)_{before} = (m \cdot h + m \cdot c \cdot T)_{after}$$

This can be done as follows:

$$(2 \cdot g \cdot h \cdot m + 2 \cdot g \cdot m \cdot c \cdot T)_{before} = (2 \cdot g \cdot h \cdot m + 2 \cdot g \cdot m \cdot c \cdot T)_{after}$$

$$(2 \cdot g \cdot h \cdot m + 2 \cdot g \cdot m \cdot c \cdot T + mv^2)_{before} = (2 \cdot g \cdot h \cdot m + 2 \cdot g \cdot m \cdot c \cdot T + mv^2)_{after}$$

8) Hierna kun je je gevonden wet met eerder gevonden wetten combineren. Dit hebben we ook in serie 5 gedaan, dat gaat als volgt:
Allereerst combineren we de volgende twee wetten:

$$(m \cdot h)_{\text{voor}} = (m \cdot h)_{\text{na}}$$

$$v^2_{\text{voor}} + (2 \cdot g \cdot h)_{\text{voor}} = v^2_{\text{na}} + (2 \cdot g \cdot h)_{\text{na}}$$

Dit doen we door alles met massa m te vermenigvuldigen.
Zodoende krijgen we de volgende wet:

$$mv^2_{\text{voor}} + (2 \cdot g \cdot h \cdot m)_{\text{voor}} = mv^2_{\text{na}} + (2 \cdot g \cdot h \cdot m)_{\text{na}}$$

Vervolgens gaan we deze wet met nog een andere wet, $(m \cdot h + m \cdot c \cdot T)_{\text{voor}} = (m \cdot h + m \cdot c \cdot T)_{\text{na}}$, combineren.
Dit gaat als volgt:

$$(2 \cdot g \cdot h \cdot m + 2 \cdot g \cdot m \cdot c \cdot T)_{\text{voor}} = (2 \cdot g \cdot h \cdot m + 2 \cdot g \cdot m \cdot c \cdot T)_{\text{na}}$$

$$(2 \cdot g \cdot h \cdot m + 2 \cdot g \cdot m \cdot c \cdot T + mv^2)_{\text{voor}} = (2 \cdot g \cdot h \cdot m + 2 \cdot g \cdot m \cdot c \cdot T + mv^2)_{\text{na}}$$

Figure 9. In this example several of the procedural steps are illustrated by concrete examples

Of the pairs that successfully combined the partial laws many appeared to show at least one of these two types of reflection. Out of the explicitly unsuccessful pairs most appeared to show neither type of reflection. We therefore hypothesized that the two types of reflection may help student pairs in understanding the complex combination procedure and decided to analyze both types of reflection further. To investigate which of these two types of reflection is most effective we will now look at both types of reflection and compare them to the success of students in actually performing the final combination procedure themselves. Because of the small number of student pairs involved in this research and because of posing our hypothesis after having seen the results we think that we can only hint at possible relations between being able to perform a complex procedure and reflecting upon that procedure. We therefore limited the statistical analysis to merely descriptive statistics.

Analysis for reflecting from concrete to abstract (type I)

We considered student pairs to reflect spontaneously from concrete procedural steps towards abstract descriptions of those steps if they gave a description of two or more procedural steps next to performing them in any of the three scientific assignments (see Figure 8).

There were no cases in which only one procedural step was described more generally. All student pairs that merely performed the mathematical procedure were categorized as not having reflected spontaneously from concrete steps towards an abstract description.

Student pairs that did not hand in relevant data on one of the assignments and did not show this type of reflection in any of the other assignments were considered to be unsuccessful as well.

Analysis for reflecting from abstract to concrete (type II)

We considered student pairs to reflect upon a description of the procedural steps if they added concrete examples to one or more of these steps in any of the three scientific assignments in worksheets where they were asked to write down the steps that they thought were necessary (see Figure 9).

All student pairs that merely gave a description of the procedure in these worksheets were categorized as not having reflected spontaneously upon the abstract description by adding concrete steps.

Student pairs that did not hand in relevant data on one of the assignments and did not show this type of reflection in any of the other assignments were considered to be unsuccessful as well.

Results on reflections type I and II combined

Having established an analysis scheme for the two types of spontaneous reflection we can now investigate the relation between successfully combining partial laws and reflection more quantitatively.

Out of the 16 pairs that successfully combined partial laws 13 also showed at least one of the two types of spontaneous reflection. The 3 remaining pairs did not show either type of reflection. Out of the 14 explicitly unsuccessful pairs 11 showed neither type of reflection. The 3 remaining pairs did show one of the two types of reflection.

This means that 24 out of the 35 pairs (69%) in total confirm our hypothesis which says that reflection helps students in understanding the complex combination procedure. Out of the other groups 6 (17%) contradicted our hypothesis and 5 did not hand in their final scientific report (14%). An overview of these results is given in Table 9 and Table 10.

Table 9. Percentages of students confirming or negating our hypothesis

Reflection helps in performing complex procedures	Number of student pairs (%)
Confirmed	24 (69%)
Contradicted	6 (17%)
Undecided/Missing data	5 (14%)

Table 10. Relation between reflecting and successfully combining partial laws omitting missing data

	Unsuccessful combination	Successful combination
Reflection type I or II	3	13
No reflection	11	3

Out of the student pairs that had handed in their scientific reports 80% (24/30) confirmed our hypothesis. With 69% of our total population confirming our hypothesis we now separately investigated the two types of reflection to see which of the two was the most effective.

Results on reflection type I

Those student pairs that were successful in combining partial laws together with showing either type of spontaneous reflection (13 pairs) all showed the type of reflection in which they added a general description to concrete procedural steps. Because the pairs that did not show either type of reflection logically also did not show this first type of reflection the relation between this type of reflection and successfully combining partial laws is exactly the same as above. An overview is given in Table 11.

Table 11. Relation between adding abstract descriptions to concrete procedural steps and successfully combining partial laws omitting missing data

	Unsuccessful combination	Successful combination
Reflection type 1	3	13
No reflection type I	11	3

Results on reflection type II

Not all student pairs that were successful in combining partial laws together with showing either type of spontaneous reflection (13 pairs) showed the type of reflection in which they illustrated their procedural description with concrete examples. Out of the 16 pairs that were capable of combining partial laws only 8 showed this type of reflection from abstract to concrete. Out of the 14 pairs that were not capable of combining the final partial law only 1 pair did show this type of reflection. An overview is given in Table 12.

Table 12. Relation between illustrating abstract descriptions of procedural steps with concrete examples and successfully combining partial laws omitting missing data

	Unsuccessful combination	Successful combination
Reflection type II	1	8
No reflection type II	13	8

Exceptions

Eight student pairs successfully performed the final combination procedure but did not show reflection of type II. Five out of these eight did show reflection of type I showing that this type of reflection is more common and likely more effective. The three other student pairs that were successful did not show either type of reflection according to our analysis. Two out of these three student pairs did add very short

descriptions of a few procedural steps but too short to clearly state that they had shown reflection type I. The third pair asked for a lot of guidance from the teacher during the final combination procedure. Apparently this guidance helped them through the process.

Three student pairs that were unsuccessful in performing the final combination procedure did show reflection type I. One of these three pairs also showed reflection type II. All three pairs gave a proper procedural description for combining partial laws. One of the three pairs made a couple of errors in performing the final combination procedure. This was not the pair that showed both types of spontaneous reflection. The two other pairs ended their combination procedure efforts prematurely after merely establishing the new partial law like most other unsuccessful pairs. All three pairs showed therefore that they were able to describe the combination procedure but lacked skills in performing several of the necessary steps.

Conclusion

A large fraction of our population of students (69%) showed that when they spontaneously reflected on the given assignments they performed better in performing the final related assignment as well or when they did not reflect on the given assignment they performed worse on the final assignment. Our results do not prove a direct causal effect but does make a case for stimulating reflection on given tasks.

In our teaching-learning sequence reflection spontaneously took place when concrete steps are given a more general description or when a procedure description is illustrated by concrete examples. Both of these types of reflection appear to contribute to a better understanding of the task. Every student pair in our population that showed the less effective second type of reflection also showed the more effective first type of reflection.

Because most of our student pairs reflect on the procedure by spontaneously adding more general descriptions of concrete steps (e.g. describing a mathematical step next to performing it) this might be the most natural place for students to be asked for a reflection. Such concrete tasks may therefore be expanded by adding a question which not only asks to perform the given concrete task but also to describe the steps that are needed to perform the given task in a general way.

5. Discussion

Lijnse & Klaassen (2004) already asserted that reflection helps students understand the tasks at hand better. Our research shows a new and clear example of this effect.

Our requirement for successfully combining partial laws only selects those student pairs that are capable of repeating the sequence of actions to expand the law ever further themselves. This of course does not necessarily mean that they have come to understand that the combination procedure can be continued much further. Whether the student pairs really understood the consequential concept of energy conservation is investigated elsewhere (Logman, 2014).

The research was confined to only a small population. Research on larger groups should be able to come to more precise conclusions. In our research spontaneous reflection appears to be at least partly the cause for better performance on related tasks. With a larger population it would also be interesting to follow the group of students that do not fit the observed pattern more precisely to reveal further influences on students' final performances. It may also shed more light on whether reflection has a positive causal effect on the final performance on a related task.

Both types of reflection appear to have their influence on the performance of students in the final task. From our results we cannot separate the effects from both types of reflection. Research on assignments in which one type of reflection is stimulated and the other is not and vice versa may shed more light on the position in which (if not both) it is most effective. Furthermore interviewing students about why they showed spontaneous reflection in a certain worksheet may reveal a contextual reason for students to reflect at that specific point in the teaching-learning sequence.

The conclusions of our research may also be applicable when combining partial gas laws or in other situations in which physicists encounter combination procedures of physical laws.

References

- Borsboom, J., Kaper, W. H., & Ellermeijer, A. L. (2008). The relation between context and concept in case of forming an energy concept. In *GIREP 2008: Physics Curriculum Design, Development and Validation*. Nicosia, Cyprus.
- Freudenthal, H. (1991). *Revisiting mathematics education: China lectures*. (H. Freudenthal, Ed.). Dordrecht: Kluwer Academic.

- Hugenii, C. (1728). De Motu Corporum ex Percussione. In *Opera Reliqua quod continet Opera Posthuma* (Vol. 2, p. [714] 95). Amstelodami: Janssonio-Waesbergios. Retrieved from <http://www.e-rara.ch/zut/content/pageview/1370199>
- Joule, J. P. (1850). On the Mechanical Equivalent of Heat. *Philosophical Transactions of the Royal Society of London*, 140, 61–82. Retrieved from <http://rstl.royalsocietypublishing.org/content/140/61.short>
- Joule, J. P., Scoresby, W., Playfair, L. P., Kelvin, W. T., & Physical Society (Great Britain). (1884). On Matter, Living Force, and Heat. In *The Scientific Papers of James Prescott Joule* (p. 149). The Society.
- Kaper, W. H. (1997). *Thermodynamica leren onderwijzen. CD-beta reeks* (Vol. 27).
- Lijnse, P., & Klaassen, K. (2004). Didactical structures as an outcome of research on teaching-learning sequences? *International Journal of Science Education*, 26(5), 537–554.
- Liu, X., Ebenezer, J., & Fraser, D. M. (2002). Structural characteristics of university engineering students' conceptions of energy. *Journal of Research in Science Teaching*, 39(5), 423–441.
- Logman, P. S. W. M. (2014). *Students Reinventing the General Law of Energy Conservation*. University of Amsterdam. Retrieved from <http://dare.uva.nl/record/471051>
- Logman, P. S. W. M., Kaper, W. H., & Ellermeijer, A. L. (2010). Energy: an experiment-based route from context to concept. In *GIREP-ICPE-MPTL 2010 International Conference, Teaching and Learning Physics today: Challenges? Benefits?*. Reims, France.
- Logman, P. S. W. M., Kaper, W. H., & Ellermeijer, A. L. (2011). Motivating students to perform an experiment in technological design contexts. In *GIREP-EPEC 2011 International Conference, Physics Alive* (pp. 98–103). Jyväskylä, Finland.
- Logman, P. S. W. M., Kaper, W. H., & Ellermeijer, A. L. (2012). A Guided Re-invention Path Towards a More Versatile Concept of Energy Conservation For Secondary School Students. In M. F. Taşar (Ed.), *Proceedings of The World Conference on Physics Education 2012, The Role of Context, Culture, and Representations in Physics Teaching and Learning* (pp. 483–490). Istanbul, Turkey: Pegem Akademi.
- Van den Akker, J., Gravemeijer, K., McKenney, S., & Nieveen, N. (2006). *Educational design research*. London: Routledge.

Affiliation and address information

Paul Logman
 VU University Amsterdam
 Onderwijscentrum, Vrije Universiteit
 Prof. E.M. Meijerslaan 2
 1183 AV Amstelveen
 The Netherlands
 e-mail: p.s.w.m.logman@vu.nl

A New Physics Curriculum for a Vocational School.

Vera Montalbano, Roberto Benedetti, Emilio Mariotti.

Department of Physical Sciences, Earth and Environment, University of Siena, Italy.

Abstract

In vocational education, physics curriculum usually offers laboratory experiences very far from professional practice. A new approach is proposed for an agricultural technical school, where many activities in laboratory are focused on the understanding the physics necessary to fully acquire professional topics. We present the initial proposal and how it is changed during a pilot study. Light and shadows in implementing the curriculum throughout the school are presented.

Keywords

Vocational education, physics curriculum, motivational strategies, laboratory.

1. Introduction

Physics is considered a prerequisite for many professional subjects in vocational education. In Italian professional curricula, physics courses are planned in early years and focused on activities in laboratory. Despite selected physics topics are essential for understanding many professional subjects and practices, their relevance in everyday situations, in which students will ultimately work, often remains hidden. Regrettably, current practice is very different from one school to another. Sometimes laboratory is not properly equipped and usually physics and vocational teachers do not coordinate their educational action. Thus, physics is usually perceived as a boring set of laws very far from professional experience. Theories and empirical research about the interrelation of motivation and learning have a long tradition in education (Krapp, Renninger and Hidi 1992, Alderman 2008, Fisher and Horstendahl 1997). From an educational point of view, it is essential to understand why and how students can become interested in new content and subject areas (Schiefele 1991, Trumper 2006). Interest and motivation are seen as basic concepts to describe students' learning in a physics classroom. According to Hidi, Renninger, and Krapp 2004, an interest always refers to focused attention and/or engagement with the affordances of a particular content, and it is this content that can be said to provide possibilities for (interest-based) activities. In empirical studies, a vocation-related interest can refer to a rather specific topic or a certain kind of activity. However, the object area of interest can also be defined by the whole spectrum of contents and actions that make up the curriculum of an entire educational program. Empirical findings suggest that an interest-based motivation to learn positively influences both how learners realize and organize a given learning task (e.g., the kind of learning strategies used) and the quantity and quality of learning outcomes (Baumert and Köller, 1998; Hidi, 1990, 2001; Krapp, Hidi, and Renninger, 1992; Renninger, 2000; Schiefele, 2001). According to Schiefele and Csikszentmihalyi 1994, some evidence for the importance of subject-area-specific motivational orientations can be arise in empirical studies where a specific motivational orientation subject-matter-interest outperformed an achievement motivation, not only in predicting the quality of experience in class, but also in predicting the level of achievement at the end of the school year.

Physics curriculum frames developed in this direction were tested at school (see for example Häussler and Hoffmann 2000 for a government-funded school experiment in Germany). Empirical research revealed that students in the range between 11 and 16 years of age are not little scientists who strive for inquiring the laws of nature for their own sake. Rather, they are interested in physics in the context of its practical applications, its potential to explain natural phenomena, or in the context of chances and risks which lie in physics-based technologies.

Exploring and understanding how transfer of knowledge can be made more effective in vocational education is an unavoidable step in order to improve the learning process in this context (Guile and Young 2003). Motivation and interest can facilitate the learning process by enhancing the engagement of students in laboratory, and in classroom too, by selecting concepts that represent appropriate challenge and by favouring a classroom climate that encourages positive motivation beliefs (Palmer 2005).

Recently, a pilot learning path has been realized in an Agricultural Technical Institute within the Italian National Plan for Science Degree (Montalbano 2012) and it succeeded in involving students and teachers in a more effective and motivated learning process. Starting from this positive experience, we proposed to the school's management of redesigning the physics curriculum with the aim of improving the learning in physics by enhancing the student's interest.

In the next section, we present the school context, the initial proposal discussed with physics teachers and the methodological choices. We report how the initial proposal was adapted by following teachers suggestions. Some meaningful example of lab activities and preliminary results at the end of the second year of physics curriculum are presented and discussed in the following section.

2. Designing a new curriculum

2.1 The educational context

A recent reform of the Italian secondary school changed the schedule for many subjects, by decreasing technical support in the laboratory and leaving the responsibility of the contents of the learning process to the autonomy of each school.

The Agricultural Technical Institute Ricasoli is one of 10 Italian technical special secondary schools specialized in Viticulture and Enology and the only one in Tuscany. After a course of five years, students become expert in Viticulture and Enology and, with a further annual course, they are qualified as winemaker technician.

The school occupies an area of 47 hectares (116 acres) and deals with managing an educational farm. Each last class is responsible for a vineyard and students treat all aspects from the cultivation of the vine to the grape harvest, from fermentation to bottling, oversee and determine what is needed to ensure the quality of the final product.

2.2 A pilot experience: Physics in the winery

An early experience was the realization of a learning path in this vocational school: starting from thermal equilibrium to full understanding of the measures made with the Malligand ebulliometer (see Benedetti, Mariotti and Montalbano 2013 for a full description). The device measures the alcoholic strength (alcohol concentration by volume) of an alcoholic beverage and water/alcohol solutions. The measurement is based on the different temperatures of boiling for water and ethanol, since a water-ethanol mixture has an intermediate boiling point. Wine is a hydro-alcoholic mixture and has a boiling point which decreases with the increase in content in ethanol. The explicit connection between physics observations in laboratory, the data analysis and the requested care in specific aspects in the calibration of the ebulliometer related to physics laws were involved in a virtuous loop driven by the students' interest for all process related to the production of wine.

All second classes of the school participated (5 classes, about 100 students aged 15-16). Figure 1 shows a group of students carefully following the mercury's meniscus on the Malligand's device aided by a flashlight.



Figure 1. Students during the measurement of the alcoholic strenght of a solution by using the Malligand ebulliometer.

The main purpose of increasing students' attention on physics was fully achieved. As soon as students realized the relationship with some aspects of enology, their involvement increased significantly. These results lead us to expand the topics of physics that can related to activities directly useful in technical matters.

2.3 The starting curriculum

The physics course for an agricultural technical school requires 3 hours per week for two years, including one hour in laboratory with the co-presence of a technician with no special training in physics. The curriculum was focused on classical physics and the main topics are usually the following

- MECHANICS: Physical quantities and measurement, forces and equilibrium, fluid statics, velocity, acceleration, motion in 1 and 2 dim, Newton's laws, forces and motion, energy and momentum
- THERMODYNAMICS: Temperature and heat, hints on energy
- WAVES: Waves and sound, light, elements of optics
- ELECTRICITY AND MAGNETISM: electric charge, electric field, current and resistance, magnetic field, induction, electromagnetic waves.

The laboratory is expected but few activities were carried out, usually with the teacher in an active role and students who watch.

2.4 Designing and improving a new curriculum in school practice

The first step had been to obtain the support by the school's management. The next step was to involve teachers in meetings of different types:

- Preliminary meetings with physics teachers for sharing aims and methodologies.
- Meetings with teachers of vocational matters and physics for discussing together which topics can be related and how can interplay with vocational curricula (one or two per years).
- meetings with physics teachers for monitoring and adapting the process (first year about every month, later 3-4 meetings per year).

Successful methodologies from physics education research, such as active learning, have been proposed, discussed with teachers and adapted to boundary conditions (available materials, teachers' experience, topics related to professional practices or devices).

Furthermore, we rendered available the loan of educational materials from university or other schools in PLS and full support for adapting and testing educational materials previously in department.

2.5 From properties of matter to energy

The initial proposal was to redesigning totally the physics course by using the methodology followed by Introductory Physical Science (Haber-Schaim, Cutting, Kirksey and Pratt 1999). The starting point for every topic was always an experiment performed to observe and record the behaviour of matter, measure a property, introduce the need for a concept, or to raise additional questions. Laboratories were integral and necessary parts of the learning process. They were designed for favouring group teamwork, class pooling of data, comparing results and drawing conclusions. Topics were often related closely to issues or tools relevant for students technical formation, like saccharometer or densimeter Babo for measuring sugar content in must or refractometer for measures in unfermented grape juice.

A radical choice was proposed: let be mechanics a transversal topic like energy.

The main topics were the following

- Properties of bodies: volume and mass. Measurements of volume for liquid displacement, drawbacks in the use of the volume as a measure of quantity for a body. The balance. Mass and weight: elementary introduction (phenomenological). Forces (one-dimensional and intuitive cases, dynamometer).
- Properties of the substances: point of solidification and melting, boiling, pressure, fluid statics, the hydraulic and mechanical press, i.e. static forces and moments, density of solids and liquids, the density dependence by temperature (thermal expansion following IPS, also by constructing simple tools)
- Mixtures and compounds (lab: separation of solid and liquid or the decomposition of water).
- The elements and the spectral analysis
- The electric charge: measure the electric charge with hydrogen cells, series and parallel (storing electric charge), charge, current and time, Daniell cell and the electric potential.
- The heat, the thermal effects of the current, the electrical work and the resistance (Joule effect)
- We lift an object by an engine and find out where is the missing heat.
- Potential energy, kinetic energy and the conservation of energy, the friction and the resistance of a medium, fluid dynamics.

3. How it works

3.1 First year

Since 2012, all first classes in the school followed the new curriculum (about one hundred students aged 15-16) and all physics teachers (5 participants) contributed to designing and testing the curriculum in class, while other 6 participants (3 teachers of vocational subjects and 3 technical staff) were occasionally involved in meetings.

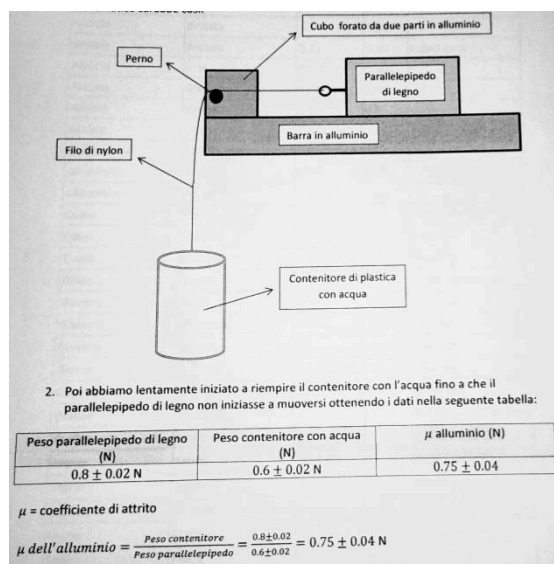

Figure 2. A schematic draw of a quantitative measurement of the static friction.

Teachers followed the initial proposal by implementing new activities in laboratory. Following a suggestion from vocational teachers, friction was introduced with a qualitative inquiry-based exploration and a quantitative laboratory were proposed at the end of the first class curriculum. The schematic draw of the quantitative experiment from the report of a student is shown in fig. 2 (for further details about the learning path on friction see Montalbano 2014).

It was not possible to perform all activities in each class because of different teaching styles, different learning difficulties and other contingent events (unforeseen absences of some teachers for health reasons). Only one class fully performed all scheduled laboratory.

Assessment was discussed and inserted in the regular assessment of science skills, to which all students in the school are annually submitted and they obtained good results.

3.2 Second year

A crisis emerged in the first meeting in the second year, after an attempt to suggest an independent assessment performed by researchers not involved in the designing process. Moreover, many concerns and doubts arose about missing parts of classical physics such as dynamics and electricity. Physics teachers (almost all with a disciplinary degree in Mathematics) were worried about security in the use of hydrogen

and Daniell cells proposed in IPS. After a careful discussion, a change in the curriculum was necessary in order to continue the research.

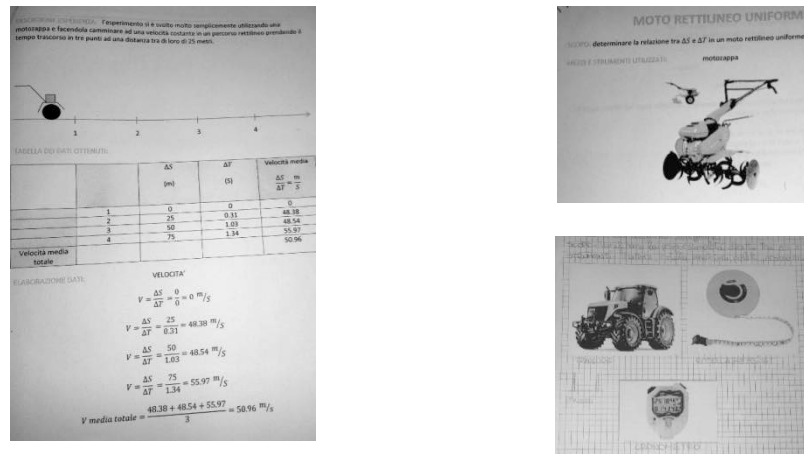

Figure 3. Extracts from students' reports about different measurements of uniform motion with two agricultural machineries in open field, a cultivator rotor tiller (top right) and a tractor (bottom right). A schematic plot of the experiment with the cultivator rotor tiller is displayed with some measurements (left).

New laboratories were designed and realized with great positive reaction from students. Some example from students' reports on uniform motion laboratory is shown in fig. 3. In particular, it is possible to underline the care and the engagement of students in preparing these reports by using the computer, by searching pictures to describe materials and instruments, in drawing a schematic plot of the experiment. These aspects are usual in reports from high school students but very uncommon in this vocational school, where sometime it is difficult to obtain any kind of report.

Once again, it was difficult to obtain an independent assessment dedicated to physics curriculum in which to test the overall effectiveness of the proposal by using tools developed in physics education research. We accepted to use the assessment performed by a national agency but teachers encountered difficulties in collecting data. Finally, the assessment could be done only through interviews to some teachers and few student' reports.

4. Remarks and conclusions

The teacher feedback was positive and indicated that an interest-based motivation to learn was arising in their students.

The activities in laboratory were very effective in engage students in an active learning process. Teachers remained really astonished by active behaviour showed by their students in some laboratories, especially in those strictly related with agricultural practices, and they declared the intention of including all these laboratories in their educational practice.

The project started with great expectations and an initial support from school's management, but the implementation had shown lights and shadows. There was no educational continuity in the school, almost all classes changed physics teacher passing to the second year.

Some teachers were usually missing in designing and monitoring meetings, some other had health problems which left the classes with temporary teachers for weeks or months. Thus, they were less involved in the implementation of the curriculum.

Assessment remains an unsolved problem. A new strategy must be implemented in the future.

Moreover, few materials from student's reports were collected and available for testing effectiveness in the learning process and researching better solutions. Moreover, it emerged from reports that some essential point was missing in lab activities (e. g. evaluation of uncertainties in measurements and the correct use of significant figures).

All these observations highlight the great difficulties in implementing the results of educational research in the school practice. Even with the full support of researchers in adapting the materials and methods to the specific reality of a school, the achievement of the result is not obvious. On the other hand when teachers test by themselves the effectiveness of new activities with their students, they become promoters of change in the school practice.

The project is still in progress and the last curriculum will be tested fully in 2015.

References

- Alderman, M. K. (2008). *Motivation for achievement: Possibilities for teaching and learning*, 2nd ed., New York: Routledge.
- Baumert, J. and Köller, O. (1998). Interest research in secondary level 1: An overview. In L. Hoffmann, A. Krapp, K. A. Renninger, & J. Baumert (Eds.), *Interest and learning: Proceedings of the Secon Conference on Interest and Gender* (pp. 241–256). Kiel, Germany: IPN
- Benedetti, R., Mariotti, E. and Montalbano, V. (2014). First Steps into Physics in the Winery. *Proceedings of The World Conference on Physics Education 2012*, 283-291.
- Fisher, H. E. and Horstendahl, M. (1997), Motivation and learning physics, *Research in Science Education* **27**, 411-424.
- Guile, D. and Young, M. (2003). Transfer and transition in vocational education: Some theoretical considerations. In Tuomi-Gröhn T. and Engertröm Y. (Eds.), *Between school and work. New perspectives on transfer and boundary-crossing* (pp. 63-81), Oxford: Elsevier Science.
- Haber-Schaim, U., Cutting, R., Kirksey, H.G. and Pratt, H. (1999). *Introductory Physical Science*. 7th Lakewood: Science Curriculum Inc.
- Häussler, P. and Hoffmann, L. (2000). A curricular frame for physics education: Development, comparison with students' interests, and impact on students' achievement and self-concept. *Science Education* **84**(6), 689-705.
- Hidi, S. (2001). Interest, reading, and learning: Theoretical and practical considerations. *Educational Psychology Review* **13**, 191–208
- Hidi, S., Renninger, K. A. and Krapp, A. (2004). Interest, a motivational variable that combines affective and cognitive functioning. In *Motivation, emotion, and cognition: Integrative perspectives on intellectual functioning and development*, 89-115.
- Krapp, A., Hidi, S., & Renninger, K. A. (1992). Interest, learning and development. In K. A. Renninger, S. Hidi and A. Krapp (Eds.), *The role of interest in learning and development* (pp. 3–25). Hillsdale, NJ: Lawrence Erlbaum Associates.
- Montalbano, V. (2012). Fostering Student Enrollment in Basic Sciences: the Case of Southern Tuscany. *Proceedings of The 3rd International Multi-Conference on Complexity, Informatics and Cybernetics: IMCIC 2012*, International Institute of Informatics and Systemics, 279-284
- Montalbano, V. (2014). An inquiry-based laboratory on friction in *ICPE-EPEC 2013 Conference Proceedings*, 1010-1017.
- Palmer, D. (2005). A motivational view of constructivist-informed teaching. *International Journal of Science Education*, **27**(15), 1853-1881
- Renninger, K. A. (2000). Individual interest and its implications for understanding intrinsic motivation. In C. Sansone and J. M. Harackiewicz (Eds.), *Intrinsic motivation: Controversies and new directions* (pp. 373–404). New York: Academic Press.
- Schiefele, U. (1991). Interest, learning, and motivation. *Educational psychologist* **26**(3-4), 299-323
- Schiefele, U. (2001). The role of interest in motivation and learning. In J. M. Collis & S. Messick (Ed.), *Intelligence and personality* (pp. 163–194). Mahwah, NJ: Lawrence Erlbaum Associates.
- Schiefele, U. and Csikszentmihalyi, M. (1994). Interest and the quality of experience in classrooms. *European Journal of Psychology of Education*, **IX**(3), 251–270.
- Trumper R. (2006). Factors Affecting Junior High School Students' Interest in Physics, *Journal of Science Education and Technology* **15**, 47-58

Affiliation and address information

Vera Montalbano
Department of Physical Sciences, Earth and Environment

University of Siena
Via Roma, 56
53100 Siena, SI, Italy
e-mail: montalbano@unisi.it

Teaching the Basic Concepts of the Special Relativity in the Secondary School in the Framework of the Theory of Conceptual Fields of Vergnaud

María Rita Otero^{1,2}, Marcelo Arlego^{1,2,3}, Fabiana Prodanoff^{4,5}

¹ *Núcleo de Investigación en Educación en Ciencia y Tecnología, Facultad de Ciencias Exactas, Universidad Nacional del Centro de la Provincia de Buenos Aires, Tandil, Buenos Aires, Argentina*

² *Consejo Nacional de Investigaciones Científicas y Técnicas, Argentina*

³ *Instituto de Física La Plata, Universidad Nacional de La Plata, Buenos Aires, Argentina*

⁴ *Facultad de Ingeniería, Universidad Nacional de La Plata, Buenos Aires, Argentina*

⁵ *Facultad de Ingeniería, Universidad Tecnológica Nacional, Sede Regional La Plata, Buenos Aires, Argentina*

Abstract

In this work, we investigate the conceptualization of the basic aspects of Special Relativity (SR) at secondary school level. We have conducted our research along the lines of the Theory of Conceptual Fields (TCF) proposed by Vergnaud (Vergnaud, 2013). The investigation consisted in the design, implementation and evaluation of a didactic sequence specially elaborated to conceptualize the basic aspects of SR. The proposal is composed by eight situations, complemented with a set of exercises. It was carried out in two classrooms with students of the last year of secondary level (17 years old, N = 43).

The conceptualization was analyzed in a classroom context, where the selected situations are essential to promote the emergence of the relevant concepts.

Keywords: Physics teaching and learning, secondary level, Conceptualization, Special Relativity.

1. Introduction

The curriculum of the high school in Argentina proposes the study of the basic concepts of Relativistic Physics. In particular, in Buenos Aires province, the topic Special Relativity (SR) is part of the discipline Classical and Modern Physics, of 6th year high school, with natural-sciences orientation.

Contrary to the stipulations of the high school curriculum, the contents of modern and contemporary physics are (in general) not studied at this level. However, commonly students show interest in modern physics topics, and have more information and knowledge than the supposed one, due to the variety of media at their disposal. It is clear that the study of SR is relevant due to the deep revolution it caused on common sense aspects about space and time. But from a wider perspective it also brings sense to the study of Galilean-Newtonian relativity, as a previous step to its conceptualization within the SR framework.

The researches on the teaching of the topic relativity, focusing on the conceptualization of the basic aspects, are scarce. Here we briefly review illustratively some of them. The works (Saltiel, 1980; Hewson, 1982; Posner, 1982; Villani & Arruda, 1998, Villani & Pacca, 1996; Pietrocola, 1999; de Hodson, Kermen & Parizot, 2011; de Hodson, Kermen, 2013) analyze the conceptualization of relative motion in the Galilean context, especially at University level. Regarding proposals to teach SR, some results indicate that students do not use SR concepts, but keep their pre-SR ideas to interpret SR results (Villani & Arruda, 1998). Finally other works (Perez & Solbes, 2003, 2006) explore epistemological, historical and conceptual aspects of the SR with teachers and students of physics education. They conclude that in general teachers introduce the

concepts uncritically and with a weak knowledge of the basics of the theory, in detriment of an appropriate conceptualization by part of the students.

The aim of this work is to contribute to the development of a Didactics of the Special Theory of Relativity and the study of the conceptualization process of their fundamental notions, in students of the last years of high school. The didactic component of our research requires the specification of the Reference Conceptual Structure (RCS) for the SR (Otero, 2006). This entails an epistemological and didactical analysis of fundamentals of SR, in order to propose a potentially viable sequence, adequate to high school. The didactic performance and viability of the sequence are experienced in 6th year high school physics courses, together with the analysis of the conceptualization by part of the students. The investigation assumes the complementarity of the didactic and cognitive dimensions.

2. The Theory of Conceptual Fields

The Theory of Conceptual Fields (TCF) is a cognitive theory that brings a coherent and operative framework, organized around a set of basic principles, to study the learning process and the development of complex concepts and competences. By providing a scenario for addressing learning aspects, the TCF is also relevant for Didactics (Vergnaud, 1990). From the point of view of the TCF, the conceptualization takes place in all areas of human experience: family, compulsory school, professional training, employment, etc. However there are particularly suitable contexts, for instance, the learning of physics and mathematics topics requires a high level of conceptualization, which may emerge in situations that high school can recreate more likely than any other social institution (Otero, M. R.; Fanaro, M. A.; Sureda, P.; Llanos, V. C.; Arlego, M., 2014).

The TCF proposes that in every field of knowledge, certain processes of conceptualization are needed. These processes emerge in some kind of situations and events, evoking the development of certain types of activity. Therefore, it is necessary to explicit the knowledge of reference from which the teaching will be conceived, the knowledge to be taught and their transformations, as well as the one it is actually taught, taking into account the transpositive processes (Chevallard, 1985).

The specificity of the acquisition processes in each conceptual field leads to Vergnaud linking cognitive development in a certain domain, with teaching, that is to say with Didactics (Vergnaud, 2013).

3. Operational form and Predicative form of knowledge

The operational form of knowledge is what allows the subject to act in a given situation, whereas the predicative form consists in stating the relations between objects. There is a huge complexity in doing and speaking about what is done (Vergnaud, 2007). But while teaching is irreplaceable in the process of conceptualization, it cannot be reduced to put into words the conceptual content of knowledge. The enunciation is essential in the process of conceptualization.

In particular, the difficulties students have in learning physics and mathematics show the complexity of the situations involved, and the thinking operations necessary to treat them.

4. Concept

Vergnaud proposes a pragmatic -useful and functional- definition of concept. A concept can be defined by the conjunction of three different sets, which are not independent of each other (Vergnaud, 2013).

$$\text{Concept} = \text{def} (S, I, L),$$

where,

S: is the set of situations that give sense to the concept.

I: is the set of operational invariants that integrate the schemes evoked in the situations.

L: is the set of linguistic and symbolic representations (algebraic, graphical, etc.) that allow representing the concepts and their relationships.

The operational invariants are of two types: concepts-in-action, defined as categories pertinent to the subject in the situation, and theorems-in-action, that are affirmations validated by the subject. In this way, the concept involves, on one hand, a component which is property of the subject but related to the situation, such as the operational invariants present in the schemes. On the other hand, a concept involves a link to "the real" as the types of situations that interact dialectically with the schemes. Finally, the concept comprises a semiotic component, which refers to the systems of signs or representations, used to enunciate the concepts,

their relationships, and to refer to the objects (Vrgnaud, 2007, 2013).

5. Investigation methodology

The design of a didactic sequence involves three main phases. The first one, known as priori analysis, is the construction of a reference conceptual structure (RCS), which is the basis for the design of a number of situations, whose resolution requires the emergency of certain concepts. The second phase comprises the design and development of the didactic sequence itself, based in the priori analysis. Finally, the sequence is tested in one or more pilot projects to generate a posteriori analysis, which in turn will allow an eventual sequence reformulation. This process generates a cycle that leads to a relative stabilization of the main parts of the sequence, with the modification or addition of more tasks to enforce conceptualization of relevant topics if necessary, or conversely, reduce them.

The research has exploratory, qualitative and ethnographic character. In each class a situation is proposed to students, who work in small groups. Class by class student protocols are collected and scanned, to be returned the next class. In addition, all classes are audio-recorded, and the teacher, who is also the researcher, carries out participant observation. Other researchers of the team perform non-participant observation. The protocols are analyzed considering the situations, the theorems-in-action and representation systems used by students: verbal (oral and written) graphic, numeric and algebraic. Here we present the results of the testing of the original sequence in two courses of sixth year of secondary school ($N = 43$). This gives rise to a modification of the sequence, which is also described as part of the work.

6. Reference Conceptual Structure for Special Relativity Theory

The SR describes the kinematic and dynamic behavior of objects without taking into account gravitational effects. It is possible to develop the SR on the basis of the two Einstein postulates:

P1: The Principle of Relativity: The laws of physics are the same for all inertial observers.

P2: Invariance of the speed of light: The speed of light c is constant for all inertial observers in the vacuum and is the upper bound for any speed.

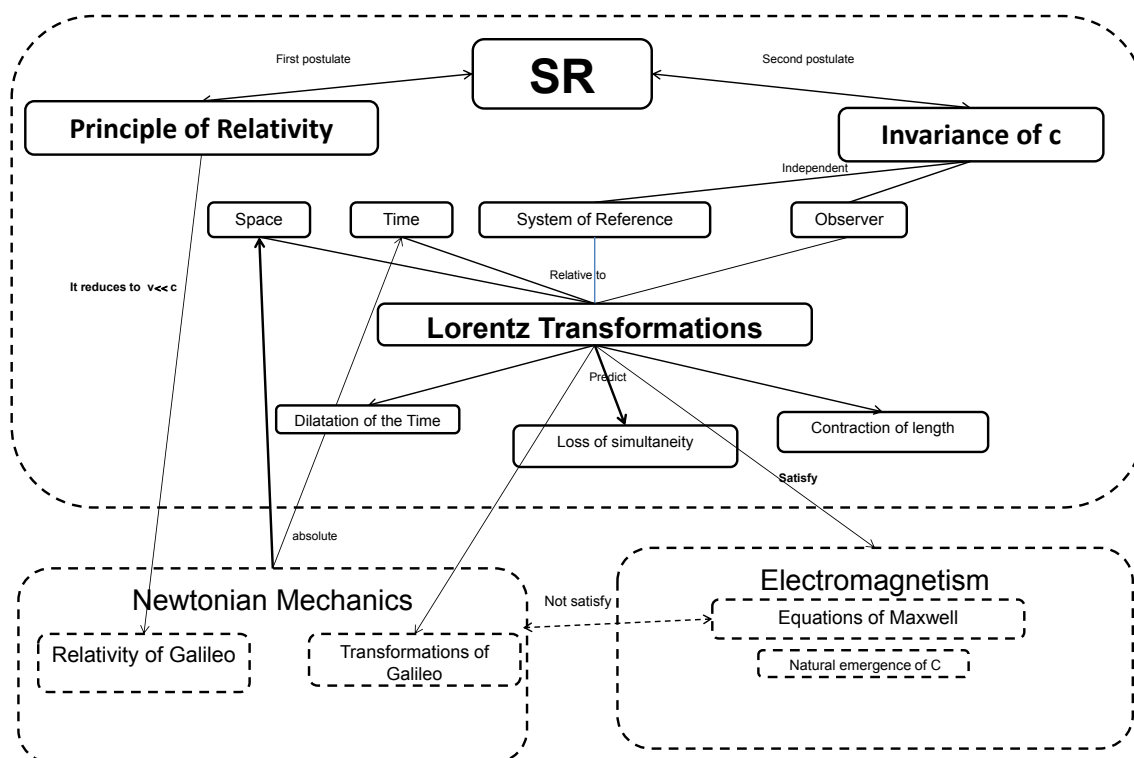

Figure1: Scheme of the Reference Conceptual Structure (RCS) for the Special theory of Relativity

In the first postulate, Einstein generalized the principle of relativity to all physical systems. The second postulate raises the speed of light in vacuum to the range of universal constant. Therefore, the laws of physics are invariant (principle of relativity) under the Lorentz transformation, which for low speeds compared with c reduces mathematically to the Galilean transformation.

These two, seemingly harmless postulates, working together lead to a series of surprising predictions that challenge the ideas of space, time, mass and energy, deeply rooted in our everyday experience of low speeds (compared with c). Figure 1 shows schematically the interrelation between the different concepts involved in the RCS for SR.

In this proposal the effects of relativistic dynamics are not studied. Therefore some relevant topics, such as the relationship between mass and energy are beyond the scope of this research.

7. Didactic Sequence

Part 1: Classical kinematics and Galileo's Principle of Relativity

In this part the concepts of reference system, observer, measuring of length and time are discussed. After that, the concept of relative motion, ie, respect to different reference systems, and the law of addition of velocities (much smaller than c) are discussed.

Finally, situations to evidence the impossibility of distinguishing between rest and uniform motion are proposed, and thus reconstructing the Galilean relativity principle in the RCS proposed.

Part 2: Postulates of Special Relativity

The Postulates are proposed as follows:

P1) it is impossible to distinguish the rest of the uniform translation of a reference system.

P2) the speed of light in vacuum c , is a universal constant, independent of the source movement.

Part 3: Main kinematic Special Relativity results

In this part, we propose situations to be analyzed from the SR point of view. In appearance, the SR postulates introduced, would seem "acceptable" from the point of view of intuition, rooted in a world of low speeds compared to c . That is, students, at the beginning, do not suspect of the counter-intuitive consequences of these postulates.

We start by proposing a situation where the direct application of the principles reveals the relativity of simultaneity, ie that while some observers state that two events have happened at the same time, others measure different times.

After presenting this first counter-intuitive challenge to students, we propose situations where the phenomena of time dilation and length contraction are manifest. This gives rise to the analysis of relativistic law of velocities addition.

It is important to emphasize the range in which relativistic aspects are relevant. The large value of c compared to the ordinary speeds which we are used, deprive us of experiencing phenomena such as time dilation and length contraction.

To promote the conceptualization of these experimental results, we propose the didactical strategy of considering the hypothetical case of c being of same order of magnitude than ordinary speeds. In this case, relativistic effects would be observable and would not represent a contradiction to intuition.

8. Situations proposed in the original Sequence

First part

S1 *How can anyone say that someone or something else is moving or not? Give examples, write your answer and if you want draw pictures.*

S2 *I am traveling by car on a straight and long road. I see another car coming from the front. My travel partner says that this car is approaching us at 150 km / h. The speed limit on this road is 80 km / h. My partner says that this car is violating the maximum allowed speed. I say no, because we are traveling at the speed limit. Who is right? Could you mathematically represent this situation?*

S3 *I am moving with a speed v with respect to the street to benefit from the "green wave" on an avenue. A car traveling in the right lane is going twice as fast as I with respect to the road. What is its speed relative to me? Does the other car benefits from the "green wave"?*

S4 *Build a pendulum by tying a rubber ball at the end of a string and analyze what happens when you perform the following actions:*

a) *You are walking in a straight line with your pendulum in one hand and you stop suddenly.*

- b) You are walking in a straight line with your pendulum in one hand without accelerating nor braking.
 c) You are walking in a straight line with your pendulum in one hand and you start to run.
 d) You are standing with your pendulum in one hand.
 e) You go by car or bike and take a curve.

Draw pictures or diagrams of the different cases and explain them

S5: Suppose we were locked in a train wagon or in a car and can't see out, or take any external reference, but we have a pendulum. Is there anything we can do to find out if we are moving?

Second part

S6: A person stands right in the middle of an empty truck trailer, which moves on a straight road with a constant speed v (respect to the road). The observer has a device that can shoot rubber bullets or light beams (laser) forwards and backwards at the same time. If the person fires the rubber bullets

Which one came first to the trailer edges?

What if the person does the same with the light?

Third part

S7: An observer is sitting right in the middle of a closed truck trailer moving at a constant speed v , respect to the road. On the roof of the trailer there is a plane mirror. The observer has a device that can emit a beam of light perpendicular to the ceiling. The ray hits the mirror and is reflected back toward the viewer. How long does the ray of light take to go to the mirror and back to the observer?

a) For the observer in the truck

b) For another observer who is standing on the road.

S8: An observer is sitting right in the middle of a trailer that moves at a constant speed v , with respect to the road. The observer on the trailer says that the length of the trailer is L . What trailer length would measure another observer standing on the road? Consider different and coherent values for L and v .

Answer previous question by supposing (hypothetically) that $c=300$ km/h.

9. Data Analysis

In situations 1-3 the students managed the use of Galilean speeds addition in one dimension, and we could said that the situations functioned properly. In the situation 4 the students conducted experiments in the schoolyard with enthusiasm. Some brought a bike to experience what was happening with the pendulum while they were turning. The students expressed their ideas in more than one system of representation, which indicates an appropriate level of conceptualization. It started implicit in action to become explicit in different representational formats. Most of the responses were correct and the drawings complete and coherent. This would indicate that students correctly understand the Galilean principle of relativity and the indistinguishability between uniform motion and rest in an inertial frame, as suggest the analysis of protocols:

Table 1: Relative frequency of the theorems-in-action identified in the situation 4

Theorems- in- action related to the Principle of Relativity identified in S4		
The pendulum accompanies the motion.	The pendulum moving with constant speed is the same that at rest	If the pendulum moves with constant speed, it does not move respect to me.
38/43	41/43	23/43

As an example, in the Fig. 2, (left panel), the protocol of A23 student allows us to appreciate that this student understands what happens if he suddenly stops when walking in a straight line with constant speed, if he quickly starts moving from the rest, or moves in a straight line at constant speed (a)-(c) respectively, and when he is turning (e). Similar conclusions can be obtained from protocol of B7 student, shown in Fig. 2 (right panel).

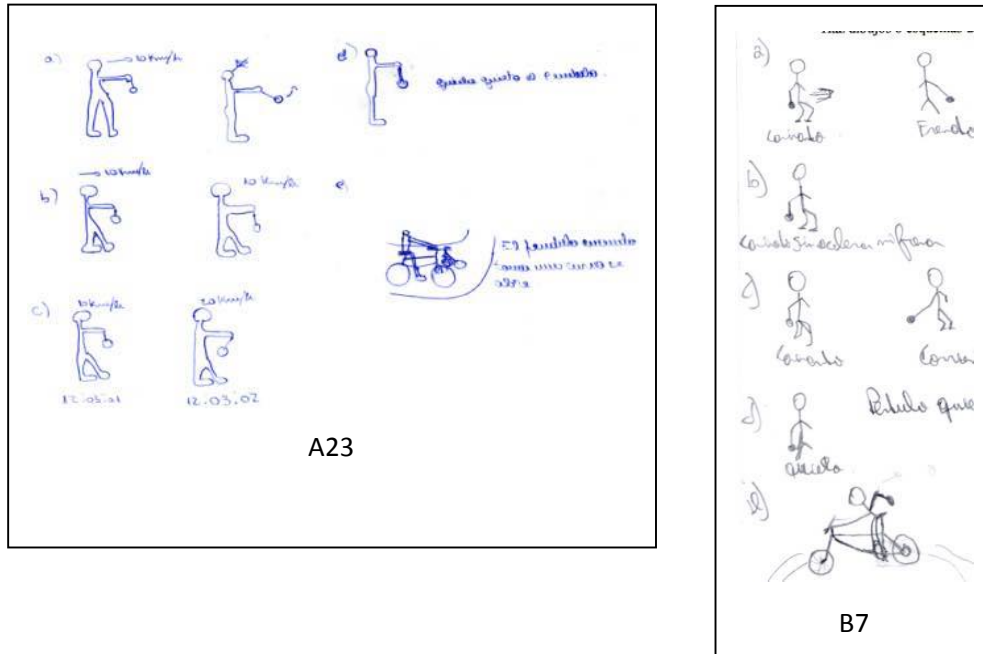

Figure 2. Protocols of A23 and B7 related to the Situation 4. The student A 23 has represented the speed increasing with the time. The protocols show how the students have drawn the pendulum motion when the bike turns.

In the Situation 5, the students had to use the ideas made explicit in the situation 4, assuming they were in an isolated system and had only a pendulum. Here they can predict what happens in the case of a speed variation but fail in the impossibility of distinguishing between uniform translation and rest. The difficulties are manifested by a drastic reduction of pictorial representations and the frequency of the theorems in action:

Table 2: Frequency of the theorems-in-action identified in the situation 5

Theorems- in- action related to the Principle of Relativity identified in S5	
I only realize if the train stops or turns.	I do not distinguish if the train is at rest or moves with constant speed.
33	14

Regarding the few pictorial representations obtained in this situation, protocols of A23, B5, B6 and B7 students (Fig. 3) show that students conceive the isolated system only seen from outside. The representation of the pendulum and arrows assume that the system is moving, which is undetectable from inside. This would indicate that they conceive the motion as absolute, rather than relative.

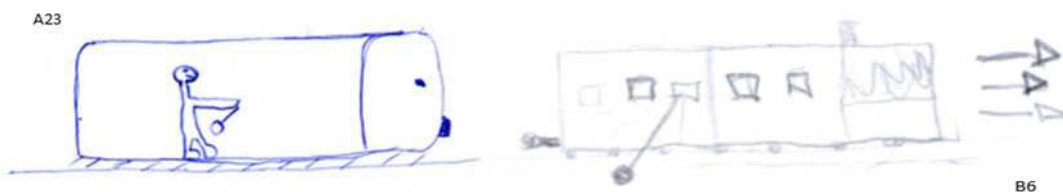

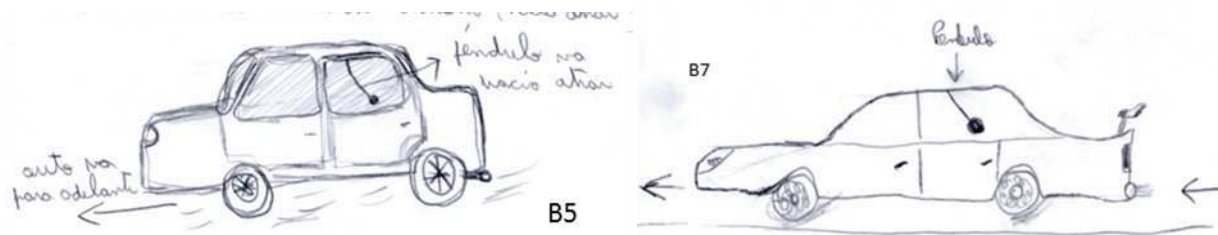

Figure 3. Pictures of the students A23, B6, B5 and B7 show arrows indicating velocity when the observer is inside, and therefore the motion is undetectable.

In the Situation 6, students have to analyze the motion of two small balls and then two light beams fired from the center of a truck trailer, assuming two observer positions: inside outside the truck trailer.

The situation requires that students jointly apply the two postulates of relativity, and in doing so with light, put in evidence the non-simultaneity for the observer on the route. However, they conclude, mostly without surprise, that the balls will not come simultaneously to the walls of the trailer, neither when viewed from inside nor from outside the truck.

Even more unexpected is that they predict that the light rays come at the same time at the opposite sides of the truck, for both, the observer who is inside as well as the one is outside the truck trailer. In other words, their predictions are exactly contrary to the expected ones. A possible reason for these unexpected predictions could be that they seem to analyze the situation from outside the truck, i.e. they always consider the truck in motion, which is undetectable from inside. Therefore, they do not apply the principle of relativity, regarding the motion as absolute.

On the other hand, for them, the light propagates at such a high speed, that in practical terms it propagates “instantaneously”, so, the arrival time of light to the walls is always the same, for all observers. The tables 3 and 4 show the frequencies of the theorems-in-action for bullets and light for both observers, respectively.

Table 3: Frequency of the theorems-in-action identified in the situation 6 when the observer is inside the trailer

Observer inside the trailer			
Rubber bullets		Beams of Light	
They arrive together	It comes first the one that is going to behind	It comes first the beam of light that is going to behind	Both beams come together
15	27	2	37

Table 4: Frequency of the theorems-in-action identified in the situation 6 when the observer is outside the trailer

Observer outside the trailer			
Rubber bullets		Beams of Light	
They arrive together	It comes first the one that is going to behind		Both beams come together
16	21		36

According to the results obtained, we conclude that the sequence as it was originally designed must be modified. It has to be re-designed in order to allow the students to correctly apply the principle of relativity, in particular disregarding the speed of the truck when they are inside it, and taking it into account when they are outside. Therefore, we have modified the situation 6 as follows:

New S₆

An observer is sitting right in the middle of an empty truck trailer. Another observer standing at the side of the road determines that the truck moves with constant speed. The observer inside the truck has a device that can launch rubber bullets forward and backward at the same instant. Complete the following table for each observer, proposing different speeds for the truck and the projectiles.

Table 5: Complete the speed of bullets and the trailer considering the observer position

Observer inside the trailer			Observer outside the trailer		
V _t (m/s)	v _{br} (m/s)	v _{bl} (m/s)	v _{br} (m/s)	v _{bl} (m/s)	V _t (m/s)
	V _b	-V _b	V _t +V _b	V _t -V _b	V _t

- a) Analyze for each observer, without doing calculations, if the bullets arrive simultaneously or not at each edge of the trailer.
- b) Calculate the meeting point (position and time) between the bullets and trailer walls, for each observer, considering different values of speeds.

In the case of rubber bullets, students could complete a table, parametrizing with different speeds and formulate the equations of motion with the established parameters. After that, by using software calculate the meeting point and the corresponding time, verifying that it is the same, for both within and outside the truck. The aim here is that students would be able to write the equations of motion (at least numerically) as we can see in table 6.

Table 6: Equations of motion to find the meeting point in the case of the observer on the trailer or on the road

Observer on the trailer		Observer on the road	
Left	Right	Left	Right
$x_{wl} = -L$	$x_{wr} = L$	$x_{wl} = -L + v_c t_l$	$x_{wr} = L + v_t t_r$
$x_{bl} = -v_b t_l$	$x_{br} = v_b t_r$	$x_{bl} = (v_t - v_b) t_l$	$x_{br} = (v_t + v_b) t_r$
$x_{wl} = x_{bl}$	$x_{wr} = x_{br}$	$x_{wl} = x_{bl}$	$x_{wr} = x_{br}$
$t_l = \frac{-L}{-v_b} = \frac{L}{v_b}$	$t_r = \frac{L}{v_b}$	$-L + v_t t_l = (v_t - v_b) t_l$	$L + v_t t_r = (v_t + v_b) t_r$
		$-L + v_t t_l$	$L + v_t t_r$
		$= v_t t_l - v_b t_l$	$= v_t t_r + v_b t_r$
		$-L = -v_b t_l$	$L = v_b t_r$
		$t_l = \frac{-L}{-v_b} = \frac{L}{v_b}$	$t_r = \frac{L}{v_b}$

Having analyzed what happens with the rubber bullets, we propose considering the case of the rays of light in the new situation 7.

New S₇

An observer is sitting right in the middle of an empty truck trailer. Another observer standing at the side of the road determines that the truck moves with constant speed. The observer inside the truck has a device that can shoot laser light beams forward and backward at the same instant. Complete the following table for each observer, proposing different speeds for the truck.

Table 7: Complete the speed of the beams of light and the trailer considering the observer position

Observer inside the trailer		Observer outside the trailer			
	V _{Lr}	V _{Lr}	V _t	V _{Lr}	V _{Lr}

- a) Analyze for each observer, without doing calculations, if laser light arrives simultaneously or not at each edge of the trailer.
- b) Calculate the meeting point (position and time) between the light beams and the trailer walls, considering different values of truck speed.

Here students should apply both principles of SR together. Although in this case the numerical solutions would not be appropriate to assess the difference in time, due to the high value of c , it is expected that the students would be able to write the analytical equations of motion. In particular, from outside the trailer, where the lack of simultaneity is explicit.

Table 8: Equations of motion to find the meeting point in the case of the observer on the trailer or on the road

Observer inside the trailer		Observer outside the trailer	
Left	Right	Left	Right
$x_{wl} = -L$	$x_{wr} = L$	$x_{wl} = -L + v_t t_l$	$x_{wr} = L + v_t t_r$
$x_{ll} = -c t_l$	$x_{lr} = c t_r$	$x_{ll} = -c t_l$	$x_{lr} = c t_r$
$x_{wl} = x_{ll}$	$x_{wr} = x_{lr}$	$x_{wl} = x_{ll}$	$x_{wr} = x_{lr}$
$\frac{-L}{-c} = \frac{L}{c}$	$t_r = \frac{L}{c}$	$-L + v_t t_l = -c t_l$	$L + v_t t_r = c t_r$
		$-L$	$L = (c - v_t) t_r$
		$= -(c + v_t) t_l$	$t_d = \frac{L}{(c - v_t)}$
		$t_i = \frac{-L}{-(c + v_t)} = \frac{L}{(c + v_t)}$	

After these situations, the sequence continues with situations 7 and 8 that are now renumbered into 8 and 9, respectively.

10. Conclusions

We have designed, implemented and analyzed a didactic sequence for the teaching of basic aspects of Special Relativity Theory in high school level. The investigation focuses on the conceptualization process during the sequence, from the point of view of the Theory of Conceptual Fields of Vergnaud.

A careful analysis of the results based on 43 student protocols from a first cycle-implementation, let us conclude that the most complex aspects of the SR for students are related on the one hand with the Principle of Relativity itself. During the first five situations they tried to conceptualize this principle without success. In this case, we identify the main obstacle in the use of the underlying theorem-in-action: “motion is absolute” which is not correct. Note that this conceptual problem is not specifically related with SR, moreover it is a pre-Galilean misconception. On the other hand, regarding the second postulate, students accept the invariance of the light speed. However due to its very large value, compared with low speed everyday experience, we detect the use of the theorem-in-action: “the light is instantaneous”. For this reason, they erroneously predict simultaneity for the case of light for all observers.

To face these obstacles, new situations were designed, aiming the emergence of appropriate operational invariants. To reach this higher level of conceptualization, the teaching of classical pre-relativistic kinematics is fundamental. Hence, it is necessary to conceptualize first, Galilean relativity as a previous step to its generalization in the framework of SR. This can only be accomplished by designing study programs revaluing classical physics, with a view towards relativistic physics.

Regarding the idea that light propagates instantaneously and therefore arrives simultaneously everywhere, the use of equations of motion to solve meeting point problems brings the possibility of direct application of the invariance of light and thus the prediction of lack of simultaneity. Although this only provides a mathematical root to the correct results, it may be considered as a first step to the conceptualization process of the relativity of the simultaneity.

Once the concept of absolute time is refused or at least accepted, the student is better prepared to deal with the concepts of time dilation and length contraction, but there is long way up to this point. Unfortunately,

traditional textbook approaches usually comprise a brief analysis of the postulates to quickly go to the “spectacular” parts of the theory. It does not have any sense moving towards the main topics without a prior process of conceptualization of the basic postulates. In this sense, our contribution promotes a firm conceptual basis of postulates, paving the way to address significantly the core issues of the special relativity.

References

- Chevallard, Y. (1985). *La transposition didactique. Du savoir savant au savoir enseigné*. Grenoble: La pensée Sauvage.
- de Hosson, C.; Kermen, I.; Parizot, E. (2010) I. Exploring students' understanding of reference frames and time in Galilean and special relativity, *European Journal of Physics* **31**, 1527.
- de Hosson, C.; Kermen, I. (2013) *Identificar dificultades de estudiantes en relatividad especial: Las nociones de “sistema de referencia” y de “evento. El Cálculo y su Enseñanza*, Volumen 4, Cinvestav, Instituto Politécnico Nacional, México, D.F. Available in http://mattec.matedu.cinvestav.mx/el_calculo/
- Hewson, P. W. (1982). A case study of conceptual change en special relativity. The influence of prior knowledge in learning. *European Journal of Science Education*, **4**, 61, 61-78.
- Otero, M.R (2006) Emociones, Sentimientos y Razonamientos en Didáctica de las Ciencias. *Revista Electrónica de Investigación en Educación en Ciencias*. **1**, 1-10.
- Otero, M. R.; Fanaro, M. A.; Sureda, P.; Llanos, V. C.; Arlego, M. (2014) *La teoría de los campos conceptuales y la conceptualización en el aula de matemática y física*. Editorial Dunken, Buenos Aires.
- Panse, S., Ramadas, J.; Kumar, A. (1994). Alternative conceptions in Galilean Relativity: Frames of references. *International Journal of Science Education*, **16**, 63-82.
- Pérez, H.; Solbes, J. (2003) Algunos problemas en la enseñanza de la relatividad. *Enseñanza de las Ciencias*, **21**, 135-146.
- Pérez, H.; Solbes, J. (2006) Una propuesta sobre enseñanza de la relatividad en el bachillerato como motivación para el aprendizaje de la física. *Enseñanza de las Ciencias*, **24**, 269-279.
- Pietrocola, M. ; Zylbersztajn, A. (1999). The use of the principle of relativity in the interpretation of phenomena by undergraduate students. *International Journal of Science Education*, **21**, 261-276.
- Posner, G., Strike, A., Hewson, P. And Gertzog, W. (1982) Accommodation of a scientific conception: Toward a theory of conceptual change. *Science Education*, **66**, 211-227.
- Saltiel, E.; Malgrange, J. (1980) Spontaneous ways of reasoning in elementary kinematics. *European Journal of Physics*, **1**, 73-80.
- Vergnaud, G. (1990): La théorie des champs conceptuels. *Recherches en Didactique des Mathématiques*, **10**, 133-170. La Pensée Sauvage, Marseille.
- Vergnaud (2007). Forma operatoria y forma predicativa del conocimiento. *Acta I Primer Encuentro Nacional sobre la Enseñanza de la Matemática; perspectiva epistemológica, cognitiva y didáctica*, edited by M.R. Otero, I. E. Elichiribehety. Facultad de Ciencias Exactas, UNICEN, Tandil, 2007, p. XXVI.
- Vergnaud, G (2013). Pourquoi la théorie des champs conceptuels? *Infancia y Aprendizaje*, **36**, 2, pp. 131-161.
- Villani, A.; Arruda, S. (1998). Special Theory of Relativity, Conceptual Change and History of Science. *Science & Education*, **7**, pp. 85-100.
- Villani, A.; Pacca, J. (1987). Students' spontaneous ideas about the speed of light. *International Journal of Science Education*, **9**, 55-66.

Affiliation and address information

Maria Rita Otero

CONICET (Consejo Nacional de Investigaciones Científicas y Técnicas, Argentina),

UNICEN (Universidad Nacional del Centro de la Provincia de Buenos Aires)

Núcleo de Investigación en Educación en Ciencia y Tecnología, Facultad de Ciencias Exactas

Pinto 399. (7000) Tandil, Buenos Aires.

Argentina

e-mail: rotero@exa.unicen.edu.ar

Teachers' Views about the Implementation of an Integrated Science Curriculum

Valeria Poggi¹, Italo Testa², Cristina Miceli¹

¹ *University of Camerino, School of Biosciences and Veterinary Medicine and School of Advanced Studies*

² *University Federico II, Naples, Department of Physics*

Abstract

Integrated science curricula have been proposed since the late '70s with the aim of improving students' scientific literacy. However, their adoption in classroom practice has been very limited. In Italy, only recently the official national guidelines have included the recommendation to adopt in the first two years of secondary school an integrated approach to science. In this study, we investigated teachers' views about the integrated science curriculum proposed in the national guidelines. Four teachers (two biology, one chemistry, one physics) participated to the study and were asked about what could be the contents that can effectively be taught with and the didactical aims of an integrated science approach. The main contents identified by the teachers for an integrated approach were: nature of science, energy, gases, energy and matter flow in systems. The teachers identified also four general cross-cutting learning objectives: a) to familiarize students with the scientific knowledge as a whole, b) to provide students with tools and methodologies to understand real-world problems and act in a responsible and conscious way, c) to experience the scientific method and train students to learn "by discover", d) to improve students' views about Nature of Science. Implications of this study for the design of Integrated Science teaching-learning sequences are briefly discussed.

Keywords

Integrated Science Curriculum, Teachers' views, Energy

1. Introduction and Aims

The implementation of Integrated Science Education (ISE) curricula in school practice has been extensively debated since the last three decades of the last century (Adeniyi, 1987; Arcà and Missoni, 1981; Hurd, 1986). ISE curricula focus on contents and methodologies common to science disciplines (Biology, Chemistry, Physics and Earth Science) and aim at fostering students' capabilities in interpreting natural phenomena from different viewpoints (Frey, 1989). Moreover, an effective integration of science disciplines may improve students' scientific literacy (de Boer, 2000). However, similarly to other curriculum innovations in science as, for instance, the Science – Technology - Society movement (Aikenhead, 2003), research results about the effectiveness of ISE approaches are often controversial (Harrell, 2010; Wei, 2009). Some studies point out that teachers' disciplinary background and attitudes toward teaching may significantly affect the implementation of integrated practices (Venville *et al.*, 2002). However, few studies have investigated teachers' ideas about the introduction of an integrated approach in their teaching practice. In Italy, this issue has become very crucial with the recent introduction in the secondary school of new national guidelines that explicitly suggest an integrated approach in science teaching, even though the scientific subjects (Biology, Chemistry, and Physics) are still taught by different teachers. As a consequence of this "separation" heritage, teachers found difficult to identify suitable topics and objectives so to cope with the new curriculum demands. This work aims to address these issues by investigating teachers' ideas about ISE curricula through the following Research Questions:

RQ1) What science topics do teachers think can be taught more effectively in an ISE curriculum?

RQ2) What learning objectives do teachers think can be most effectively achieved through an ISE curriculum?

2. Methods

2.1 Instrument

As research instrument we designed an interview consisting of 11 questions (Table 1).

The interviews, each of about 45 minutes, were transcribed and analyzed according to categories emerging from the data and refined by the authors. The scientific topics (RQ1) identified by teachers were first listed singularly and then grouped according to main areas of content. Similarly, all the mentioned learning objectives (RQ2) were first individually identified and then grouped into macro-areas.

Table 1. Text of the questions of the teachers' interview

Section	No.	Questions
Programs	1	Do you know the syllabi and the learning objectives of the other scientific subjects?
	2	Do you think that there are scientific topics which can be approached by different scientific subjects?
	3	Do you think that there are learning objectives common to the different scientific subjects?
Cooperation	4	Do you think that there are differences in the methods used by the teachers of the different scientific topics?
	5	Would you make joint planning with the colleagues of the others scientific subjects?
	6	At what school grade do you think could be particularly effective the integration among scientific subjects?
Integrated Science	7	What do you think Integrated Sciences are?
	8	What do you think about the introduction of Integrated Science teaching in vocational secondary schools (low No. 88/2010)?
Learning Objectives	9	What should be the general objectives of a course in Integrated Science?
	10	What should be the specific objectives of a course in Integrated Science?
	11	In your experience, what could be the problems that students may meet in an Integrated Science course?

2.2 Sample

Four teachers (physics, chemistry and biology) participated in this study: Alice, Carmen, Marco, Sara.

Alice has a degree in astronomy and a ten years experience in radio-astronomy research. She started teaching physics four years ago after a pre-service training programme.

Carmen, graduated in environmental sciences, has been an environmental consultant for 14 years. Three years ago, after a pre-service training programme, she won a position as a teacher of biology.

Marco is biologist by degree and he obtained a PhD in cytomorphology. Before teaching, he worked 16 years as a technician in a department of cellular biology: during this period he was involved in research and teaching programs at university level. Four years ago he left his academic position and started teaching chemistry in secondary school.

Sara, graduated in agricultural sciences, started her career 17 years ago teaching "laboratory of chemistry" in vocational schools; after ten years she began to teach biology. Before teaching, she devoted four years in wildlife monitoring research programs.

All the involved teachers, in the last three years, have been working together in the same vocational secondary school which offer programmes in two fields, agriculture and technology. The agriculture branch of the school, in which the teachers have their classrooms, has a strong tradition and attract an increasing number of students (lately over 200 new students every years). Students attend two years of general studies followed by three years of specialised education in the field either of agricultural productions or agroecology. The main reason for having chosen this specific school type is that the first two years they attend

the courses of physics, chemistry and Earth science/biology which are taught by different teachers but grouped under the same umbrella of “integrated sciences”.

3. Results

RQ1: the main content areas identified by teachers as most suitable for an ISE approach were nature of science, energy, gases, energy and matter flow in systems.

Alice: “...considering this specific type of school... the main theme would be to make the students aware of how science proceeds...”

Sara: “...I think it is energy...a topic that can be approached from many points of view even in the same science subject...”

Sara: “...when we talk about gas and the composition of atmosphere it is impossible not to enter in the area of physics and chemistry...”

Carmen: “...a main cross-cutting theme could be the “environment”...in particular if we consider the matter and energy factors... and thinking about how humans have altered the natural balance...”

Two teachers observed that any scientific topic can be effectively addressed by an ISE approach, especially if it is contextualised in real world or proposed through laboratory experiments:

Sara: “...when the teaching process start from a laboratory experiment it is almost impossible not to combine knowledge from different scientific subjects...”

Marco: “...if your goal is a deep understanding you need to give practical examples, and this forces you to move across natural sciences...”

However, teachers think that, in general, Italian secondary school science curricula are not designed in a way suitable for ISE teaching.

Alice: “...our curricula of biology, chemistry and physics are organised in a way that it is difficult to find common teaching periods...”

RQ2. The identified learning objectives were: a) familiarize students with the scientific knowledge as a whole, b) provide students with tools and methodologies to understand real-world problems and act in a responsible and conscious way, c) experience the scientific method and train students to learn “by discover”, d) improve students’ views about nature of science.

Alice: “...to help students understand that knowing science is good for life... normally our students view what they learn as completely disconnected from reality... they take what is done in the classroom as an end in itself...”

Sara: “...to be able to understand the world around and to act accordingly...”

Carmen: “...it would be important that they (the students) could read the newspaper knowing how to connect the phenomena...”

Carmen: “...the students must be able to interpret correctly the real world, in particular they must be able to relate themselves properly to the environment...”

Teachers’ responses focused also on how the different scientific subjects can be taught in similar way, proceeding from the observation to the formulation of the concepts (inductive approach).

Alice: “...the students think that because physics needs a mathematical language, then physics and mathematics proceed in the same way ... They proceed contrariwise! ... Let’s go in the lab and see what we find ... This is very difficult for students but it would be easier if followed by all the science teachers...”

While emphasizing the importance of a strong coordination, the teachers underlined the importance to preserve, at secondary school level, the main characteristics of each scientific discipline. None of the teachers thinks that integrated sciences could be a separate subject, taught by a specific teacher.

Marco: “...the fact that the scientific subjects are taught separately in the secondary school is due to the necessity to face the specificity of each one, but this determines a fragmentation of the knowledge. It is necessary to find integrated pathways when the disciplines are separately taught...”

Carmen: “...there is like a “base”, which is specific for each science subject and a lot of applications, in which the different disciplines should be integrated...”

Sara: “...the lack of integration also represents a great loss of time because a teacher must face topic of other subjects in its teaching practice...”

4. Discussion

In our study we have observed an active interest of the teachers in the introduction of ISE learning paths in secondary schools. A plausible reason for this interest is that the involved science teachers have similar cultural background and teaching methods and they are familiar with cross-subject instruction.

Differently to what national guidelines suggest, from teachers' interviews, it emerges the idea that sciences should be better taught in a fully integrated way until the middle school; in order to preserve the conceptual, procedural, and epistemological differences of each scientific discipline, at the secondary school level it could be more proper using the structure of an "interdisciplinary" or "thematic" curriculum described by Lederman and Niess (1997).

Moreover, in this study, the involved teachers think that ISE teaching in secondary schools requires reorganization of curricula and appropriate training programs. Such observation suggests that the introduction of an integrated science curriculum should be more gradual.

From this point of view, the process of integration experimented in Chinese secondary schools and described by Wei (2009) offers some good suggestions. It might be conceivable a progressive passage from a model of integration based on Educational Reconstruction to a different one in which more emphasis is given to cross-subject aspects such as scientific inquiry, nature of science, STS relationships.

5. Implications

Drawing from the above results we began to design an ISE teaching-learning sequence about one of the themes identified by teachers, namely energy. This topic emerged in the interviews very frequently and was considered by teachers as useful also to address aspects of nature of science.

Teachers' ideas were then compared to textbooks' presentations, to the syllabi of the scientific subjects of the second year of vocational schools and to the students' misconceptions reported in literature. ISE teaching learning sequences about energy already developed for different school contexts (*Tools for interdisciplinary teaching of thermodynamics*, Scuoladecs, Republic and Canton of Ticino) were also examined in depth.

Figure 1 resumes the main components of the ISE teaching learning sequence.

Specific contents usually taught in the single subjects and related to the general theme were chosen by the teachers and then reconstructed in a way suitable for an integrated teaching following the model of Educational Reconstruction (Duit *et al.*, 2012): thermochemistry (chemistry), heat and temperature (physics) and food needs for living organisms (biology).

The teaching-learning sequence was organized so that identified contents were taught by each teacher, to preserve each subject viewpoint. Modelling and experimental activities were chosen as cross-cutting methodologies.

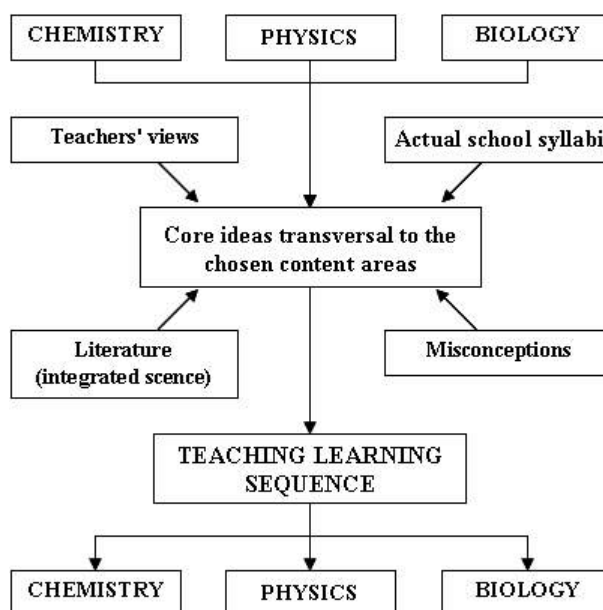

Figure 1. The components of the ISE teaching learning sequence

Drawing from results related to RQ2, learning objectives were transposed into the following goals for the teaching of energy in the framework of an integrated science instruction: a) to understand energy aspects of chemical, physical and biological phenomena; b) to identify different forms of energy and recognize how energy is transferred and converted between physical systems; c) to increase knowledge of energy content of different foods/substances; d) to understand the anthropogenic role on food chain and its impact on environment from energy viewpoint.

A pilot study will be implemented during next year with secondary school students (15-16 ys) of four classes of the vocational school in which the teachers work. To assess the effectiveness of the sequence, we will focus on students' achievements in the relevant content knowledge about energy.

Acknowledgments

We would like to sincerely thank the involved teachers for their voluntary participation in this study.

References

- Adeniyi, E. O. (1987). Curriculum development and the concept of 'integration' in science: Some implications for general education. *Sci. Educ.* **71**, 523–533.
- Aikenhead, G. S. (1992). The integration of STS into science education. *Theory into Practice* **31**, 27–35.
- Arcà, M., and Missoni, M. V. (1981). A reflection on some meanings of inter disciplinarity and integration among the sciences. *Eur. J. Sci. Educ.* **3**, 117–126.
- de Boer, G. E. (2000). Scientific literacy, another look at its historical and contemporary meanings and its relationship to science education reform. *J. Res. Sci. Teach.* **37**, 582-601.
- Duit, R., Gropengießer, H., Kattmann, U., Komorek, M. and Parchmann, I. (2012). The model of educational reconstruction – a framework for improving teaching and learning science. *Science Education Research and Practice in Europe. Cultural Perspectives in Science Education* **5**, 13-37.
- Frey, K. (1989). Integrated science education: 20 years on. *Int. J. Sci. Educ.* **11**, 3–17.
- Harrell, P. E. (2010). Teaching an integrated science curriculum: Linking teacher knowledge and teaching assignments. *Issues in Teacher Education* **19**, 145–165.
- Hurd, P. D. (1986). Perspectives for the reform of science education. *Phi Delta Kappa* **67**, 353-358.
- Lederman, N. G., and Niess, M. L. (1997). Integrated, interdisciplinary, or thematic instruction? Is this a question or is it questionable semantics? *School science and Mathematics* **97**, 57-58.
- Venville, G. J., Wallace, J., Rennie, L. J. and Malone, J. A. (2002). Curriculum integration: Eroding the high ground of science as a school subject. *Studies in Science Education* **37**, 43–83.
- Wei, B. (2009). In search of meaningful integration: The experiences of developing integrated science curricula in junior secondary schools in China. *Int. J. Sci. Educ.* **31**, 259–277.

Affiliation and address information

Valeria Poggi
School of Advanced Studies, University of Camerino
Via Camillo Lili, 55
62032 Camerino MC, Italy
e-mail: valeria.poggi@unicam.it

Vacuum: its Meaning and its Effects Throughout Experimental Activities

Marta Rinaudo, Daniela Marocchi, Antonio Amoroso

Dipartimento di Fisica Università di Torino, Italy

Abstract

The central subject of this didactic project is the vacuum, its meaning and its effects. The choice of this topic was suggested by the fact that the concepts involved are often explained from the theoretical point of view without an experimental verification. This exercise has been tested with a group of high school students, both in the university laboratory and by teachers in the classroom. In the first part we present some qualitative experiences concerning the balance of forces; before the experiment the students have been asked to make a prediction of the result and to give a physical motivation of their response. Using a bell inside a vacuum chamber we emphasize a difference between mechanical and electromagnetic waves: how the first one requires a medium for propagation. In the second part a quantitative measure relative to the phenomenon of the fall of a weight is treated. The experimental apparatus allows a measure of the acceleration of gravity in vacuum and at different pressure values. These measurements allow students to quantify the buoyant force and the force of viscous friction. In the third part it is foreseen to observe phase transitions; in particular it is required to measure the temperature of a boiling point. Using a solution of water and salt it is possible to compare the boiling point of distilled water and of this solution at the same pressure. The interdisciplinarity of physics and chemistry in this measurement is relevant. A fundamental educational part is the calibration phase. The removal of internal energy, by activating the vacuum pump, decreases the temperature of water with its subsequent freezing; this observation stimulates interesting discussions with students on the phenomena involved. This exercise enables students to understand some fundamental physical concepts; it is mainly intended for high school students.

Keywords

Secondary education: upper (15-19), laboratory activities, teaching

1. Experimental activities

The didactic activity is focussed on the topic of vacuum (Hayn, 1975). The choice of vacuum is due to the fact that the concepts involved are often explained from the theoretical point of view without an experimental verification (Sassi & Vicentini, 2009). We present here some experiments both qualitative and quantitative. The main observation of the experiment is the effect of the presence of air and the measurements of physical phenomena varying the pressure. We performed this experimental work with students coming from three different secondary level schools (ages 14,16,17) and with attending the first year of bachelor in Physics.

The first part, qualitative experiments, is shown to the whole class while the second, quantitative experiments, is only conducted with small groups of students. In particular we present a study of the fall of a weight as a function of pressure.

Each part of this work has been matched with evaluations before and after the activities.

The important features of our tests are that they require only a few minutes and they come immediately after the activity in order to understand how and what the student comprehended in laboratory.

2. Observations on the qualitative experiments

For the experiments we used an experimental setup that is composed of: a trivac rotary vane vacuum pump, a vacuum bell jar, pointer manometer, Pirani heat-conducting manometer with display, baroscope, Magdeburgo hemispheres, a bell, a balloon and a lamp. At the beginning, some qualitative understanding of the balance of forces is examined (Ku & Chen, 2013); before the experiments, we ask students to make a prediction of the result and to give a physical motivation of their response (Nissani et al., 1994). Students discuss the forces involved and how these forces change with decreasing pressure.

The baroscope in particular allows to test the effect of air on the buoyant force observing that in a vacuum only gravity is involved: in fact, in air the baroscope is in equilibrium due to the buoyant force, but upon decreasing the pressure, the buoyant force becomes negligible and only gravity is relevant. In the vacuum chamber it is also possible to show the difference in propagation between sound and light using a bell and a lamp. This experience underlines a difference between mechanical and electromagnetic waves and how the first one requires a medium for propagation.



Figure 1. Experimental setup for qualitative experiments

3. The fall of a weight

In the main part of the laboratory activity a quantitative measurement of the fall of a weight is shown, using a tube and six photocells.



Figure 2. Experimental setup for the fall of a weight

The experimental apparatus, shown in figure 2, allows the determination of the gravity acceleration in a vacuum and a measure of the speed of fall at different values of pressure. These measurements lead students to quantify the buoyant force and the force of viscous friction (Cross & Lindsey, 2014).

Experimental steps of the measure are:

- Evaluation of the ball falling without the tube
- Evaluation of the ball falling in the tube at atmospheric pressure, for the evaluation of the confining effect of the tube
- Evaluation of the ball falling in the tube in vacuum
- Measure of the fall speed at different pressure for evaluating the variation of acceleration according to the pressure.

The confining effect can be evaluated from the difference between values found for acceleration at the same atmospheric pressure with and without the tube.

The data analysis is carried out by fitting the distance between photocells versus time, at different values of pressure, thus obtaining several values of apparent acceleration due to gravity. Students could also evaluate theoretical corrections through the Reynolds number calculation, finding the value of the viscosity coefficient.

The mathematical formula that students use, are the following:

$$Re = UL/v = UL\rho_{\text{air}}/\mu$$

where:

U = average speed

L = diameter tube (internal) = 0,08 m

ν = kinematic viscosity (20 °C) = $2,3 * 10^{-6} \text{ m}^2/\text{s}$

μ = dynamic viscosity

ρ_{air} = air density in function of pressure and temperature

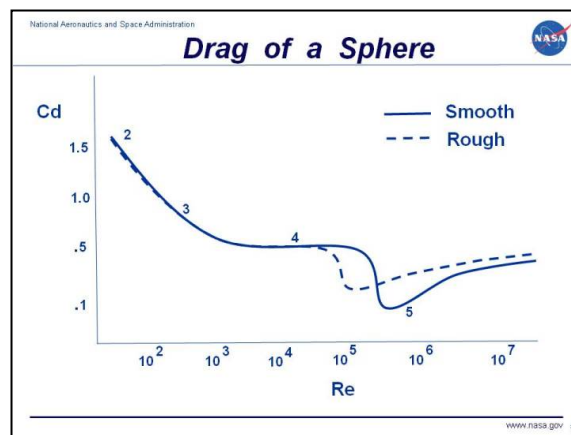

Figure 3. C_d value versus Reynolds number

By evaluating the Reynolds number, we could understand the air flow (laminar or turbulent) and obtain the coefficient C_d .

Then it's possible to calculate the friction force by:

$$F_{\text{fr}} = \frac{1}{2} C_d \rho_{\text{air}} v^2 A$$

$$\rho_{\text{air}} = p (1 - 0.378 p_v / p) / (R_a T)$$

where

R_a is the specific gas constant

p_v is the vapour pressure

The results of the measurements performed by students are the following:

- At pressure = (6.1 ± 0.1) mbar:

$$s(t) = s_0 + v_0 t + \frac{1}{2} g t^2 = 0.002 + 1.47t + 4.90t^2$$

and the acceleration is $g = (9.80 \pm 0.07) \text{ m/s}^2$

- At pressure = (993 ± 10) mbar:

$$s(t) = s_0 + v_0 t + \frac{1}{2} g t^2 = 0.002 + 1.47t + 4.64t^2$$

and the acceleration is $g = (9.29 \pm 0.07) \text{ m/s}^2$

We underline the different sensibility of the pressure measurements because the experimental setup is composed by two barometers, used by the students in different pressure conditions; in particular the first one for pressure (0-200) mbar and the second one for (200-1000) mbar.

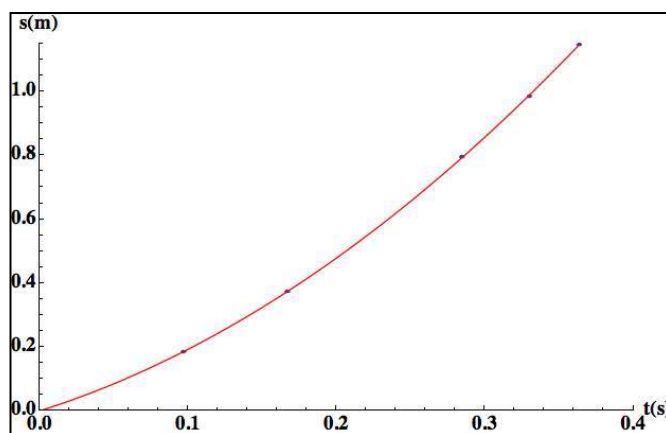

Figure 4. Parabolic fit $s(t)$ at (993 ± 10) mbar

The difference between the two values of acceleration is due to forces that are relevant in air: the viscous friction, the edge effect of the tube and the buoyant force.

4. The phase transitions of water

Changing the pressure is possible to observe the phase transitions of water that occur at different temperatures; in particular it's possible to measure the temperature of the boiling point at different pressures. A fundamental educational experience is the calibration phase in which the student evaluates the right time to read temperature and pressure at the beginning of the boiling phase.

The curve of the boiling temperature as a function of pressure can be plotted and compared with the theoretical curve for distilled water. Using a solution of water and salt it is possible to compare the boiling point of distilled water and of this solution at the same pressure. The interdisciplinarity of physics and chemistry in this measure is relevant. The removal of internal energy in the process decreases the temperature of water with its subsequent freezing; this observation allows an interesting discussion with the students on the phenomena involved.



Figure 5. Experimental setup for the observation of phase transitions of water

5. Students and teachers

The teachers involved in the project have found rich benefits in using this approach; the idea to ask students their prediction before the experiment stimulates their interest. Through the strategy of task based oriented laboratory activity, problem solving and critical thinking are encouraged and higher-order cognitive skills (HOCS) are developed.

The students have shown interest in qualitative experiments; in particular they have been fascinated by the fact that water boils at room temperature and, after a few minutes, it freezes: this observation allows students to reason about thermodynamics and the relation between pressure, temperature and volume.

Also older students (16-18 years old) have found many difficulties in making prediction on the behavior of the baroscope in vacuum. They realized that the buoyant force depends on the presence of the air, and it is greater on the sphere; however, they haven't associated different buoyant forces to different volume.

A critical point for the students has been the discussion on the balance of forces, as was underlined in the experiments of balloon and Magdeburgo hemispheres.

When we asked to students a preference about qualitative experience, they chose the one related to the bell inside vacuum chamber, probably because the explanation was more immediate and simpler compared to balance of forces.

6. Conclusions

This exercise enables students to understand some fundamental physical concepts, important also in everyday life and is mainly intended for high school students.

Below we want to underline the didactic aim of this exercise:

- Interrogating qualitative expectations helps us to introduce the topic and the theory and is perceived by the student as useful to understand the experimental activity
- In qualitative experiments it is important to reflect on the balance of forces and on the buoyant force in air
- In the part about water, we examine the calibration to determine the temperature at the onset of boiling
- The student obtains the value of g , experimentally and reflects on additional forces present in nature and on their relevance; in particular the buoyant force and the viscous force.

References

- Cross, R. and Lindsey, C. (2014). Measuring the Drag Force on a Falling Ball, *The Phys.Teach.* **52**, 169-170.
- Hayn, C. H.(1975).Archimedes and the Magdeburgo hemispheres, *The Phys.Teach.* **13**, 42-43.
- Ku, B. H. and Chen, C. S. (2013).The Jar Magic – Instructional Activities for Teaching Air Pressure, *The Phys.Teach.* **51**, 557-559.
- Nissani, M., Maier, C. L. and Shifrin, N. (1994). A guided discovery exercise for introductory physics labs, *The Phys.Teach.* **32**, 104-107.
- Sassi, E. and Vicentini, M. (2009).Il laboratorio nella didattica della Fisica, *GIORNALE DI FISICA* **4**,VOL. L, 225-240.

Affiliation and address information

Marta Rinaudo
 Department of Physics
 University of Torino
 Via Giuria, 1
 10125 Torino, TO
 Italy
 e-mail: marta.rin12@gmail.com

Antonio Amoroso
 Department of Physics
 University of Torino and INFN Torino
 Via Giuria, 1
 10125 Torino, TO

Italy

e-mail: a.amoroso@unito.it , amoroso@to.infn.it

Daniela Marocchi
Department of Physics

University of Torino

Via Giuria, 1

10125 Torino, TO

Italy

e-mail: daniela.marocchi@unito.it

Determination of the Earth Radius by Measuring the Angular Height of the Sun above Horizon

Alexander Kaplinsky¹, Konstantin Rogozin¹, Alexey Sorokin¹, Darya Shakhvorostova¹, Alexander Wolf²

¹ Altai State Technical University, 656038 Barnaul, Russia

² Altai State Pedagogical University, 656031 Barnaul, Russia

Abstract

We suggest a method of determining the Earth radius from the results of astronomical observations. The angular height of the Sun is measured by a theodolite at two sites situated on the same longitude and separated from each other by a known distance. Measurements are conducted with fixing the exact time in UTC. Mathematical processing of the results makes it possible to derive the geographical latitudes of the observation sites, from which the Earth radius is simply calculated.

Keywords

Earth radius, Sun, angular height, time, astronomical observations, transcendental equation, numerical solution.

Despite the rapid development of computer technologies in education, an important place is reserved for the real physical experiment – especially for students' understanding of the physical laws and nature of physical processes in the surrounding world.

Such experiments, particularly, are astronomical observations using advanced optical and electronic devices, specialized software, along with traditional equipment and methods of processing results. Some of the experiments in this direction can be carried out using devices and equipment conventional for many universities.

As an example of such an experiment, we derived the radius of the Earth with solar observations using a theodolite, for measuring the altitude of the Sun above horizon at certain times in two locations separated from each other.

It is known from theoretical astronomy that the maximum angular height of any celestial object above horizon in its upper culmination is given by:

$$h = 90^\circ - \varphi + \delta, \quad (1)$$

where φ is the latitude of observation site, δ is the object's declination (both measured here in degrees).

Therefore, selecting two observation sites located on the same meridian, the distance d between which is known, the radius of the Earth is defined as

$$R = d/\Delta\varphi = d/\Delta h, \quad (2)$$

where $\Delta\varphi$ is the difference of latitudes of selected sites, equal to the difference of the angular heights of the object in the upper culmination, converted into radians for both sites.



Figure 1. Measurements at the second observation site

We chose the Sun as observation object, and on June 26 – 27, 2013, made a row of measurements of its angular height above horizon in two sites located on the same longitude +83°46'53". The first site was in Barnaul, near the main building of Altai State Technical University. The second site, convenient to reach by car, was selected to the North of the city. Due to the fact that the digital theodolite used can not measure angular heights of about 60°, which is the Sun top maximal height near the summer solstice in our region, when its declination changes very slowly, we selected a different approach for measuring the difference of latitudes of the observation sites. We measured lower values of the Sun angular height, which are reached before or after the moment of its upper culmination, called the astronomical noon, also fixing the moments of measurements. The latitude of observation site was determined by numerical solution of the transcendental equation which follows from the well known formula of theoretical astronomy giving the angular height of any celestial object (Sun in our case) at any geographical position on the Earth surface and at any moment (Kononovich, Moroz, 2011):

$$\sin h = \sin \varphi \sin \delta + \cos \varphi \cos \delta \cos t, \quad (3)$$

where t is hour angle of the Sun, defined by the formula:

$$t = T - \eta + \lambda \pm 12.$$

Here T is the moment of measurement (UTC), η – the value of time equation for the date of measurement, λ – geographic longitude of observation site. All values in this formula (3) must be expressed in units of time, after which the value of t is converted into radians ($24 \text{ h} = 2\pi$ radians) and substituted into equation (3).

The first series of observations (in the city) was held on June 26, 2013, at 09:08 – 09:32 UTC (16:08 – 16:32 local time), the second (North of the city, Figure 1) – on June 27, 2013 at 09:08 – 09:36 UTC (16:08 – 16:36 local time). The height of the upper and lower edges of the Sun was measured with 2-minute intervals. For the safety of eyes, the theodolite objective lens was equipped with a special solar filter made of AstroSolar® film.

The distance d between the observation sites (54.6 km) was determined by the topographic map. All measurement data and parameters were downloaded into specially written program for numerical solution of equation (3), which provided values of latitudes of observation sites.

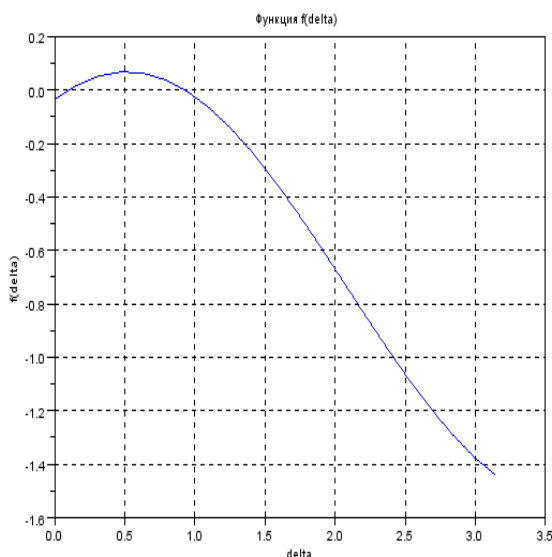

Figure 2. Graph of the function $f(\delta)$

The solution of transcendental equation (3) with respect to variable φ was done by bisection method, which does not require calculation of derivatives, but requires knowledge of boundaries of the segment containing a single root. To find this interval, original equation was written in standard form with zero on the right:

$$f(\delta) = 0,$$

where $f(\delta) = \sin \varphi \sin \delta + \cos \varphi \cos \delta \cos t - \sin h$.

Then the graph of function $f(\delta)$ was plotted (Figure 2), from which it was evident that this equation has only two roots in the interval $[0; \pi]$.

The necessary root for calculating the radius of the Earth is the right one, and it is contained in the interval $[0.5; 1]$ for all series of measurements of June 26 and 27, 2013. The second (left) root is connected with calculation method and does not correspond to the conditions of our task. Accuracy of calculations is equal to 0.000001. Average values of the roots (in radians) found for these dates are: June 26 – 0.930304, June 27 – 0.938505.

The calculated latitude values of the observation sites were substituted into (2), where it was found: $R = 7618$ km, which is 20% greater than the real one. The error of defined value is connected with the errors of measurements of the Sun angular height, because it is continuously moving in the theodolite field of view due to the Earth's rotation, giving a significant scattering of individual measurements. The typical error of individual measurements may be estimated in our case by 2 – 3 arc minutes, comparing with the Sun visual diameter (about 30 arc minutes) due to the noticeable motion of the Sun during time interval between measurements of heights of its upper and lower edges (about 20 – 30 seconds). We did not put out the task of improving the measurements accuracy, our aim was to show the principal possibility of such measurements.

Conclusion

We have shown that using existing standard equipment and information resources, it is possible for the students to conduct interesting natural studies, expanding their horizons in the field of science and enabling them to master the methods and means of such studies. We think that performing such experiments may give new knowledge and experience to the students in such fields as astronomy, geography, geometry, calculation methods, optical devices, experimental statistics, and other, relating to the experimental methods of natural studies. Probably, they can put out also new ideas for enhancing the measurements accuracy.

References

Kononovich, E.V., Moroz, V.I. (2011) *The general course of astronomy*. Librokom, Moscow (in Russian).

Affiliation and address information

Konstantin Rogozin
Altai State Technical University
Faculty of Special Technologies
Chair of Physics
Lenin St., 46, 656038 Barnaul, Russia
E-mail: krogozi@mail.ru

Implementation of Peer Instruction in Czech Schools

Jana Šestáková

Faculty of Mathematics and Physics, Charles University in Prague, Czech Republic

Abstract

Peer Instruction was originally created for engaging students in more interactive learning during physics courses at Harvard University in Boston, USA. The creator of this teaching method, professor Eric Mazur, converted his lectures during 1990s after using the Force Concept Inventory test. He realized that even though his students liked his lectures and did well in the course, they still had problems with basic concepts. A conversion from lecturing to teaching with Peer Instruction led to improving students' understanding. [Crouch, Mazur, 2001]. Inspired by this success we implemented the Peer Instruction method in our Czech schools. Cooperating with teachers from different educational levels, we are preparing a case study. Our goal is to describe the problems with first using the Peer Instruction method at Czech schools and highlight the advantages connected with teaching this way. These descriptions of the first implementation of Peer Instruction from Czech teachers will help other teachers with converting their classes. In this article we will describe support for teachers involved in the case study, which will help them with implementing Peer Instruction into their classes, e.g. a free online database of ConcepTests, a website about Peer Instruction and workshops about the method (all in the Czech language) or a free online tutorial created by The Mazur Group.

Keywords

Peer Instruction, teaching, learning, ConcepTest, support for teachers, tutorial.

1. Peer Instruction

Peer Instruction moves content delivery out of the classroom, instead assigning pre-class reading. In class, students engage in small group (at most 5 members) discussions about fundamental concepts. These conversations successfully improve students' conceptual understanding. Each ConcepTest, a question given to students to promote discussion, involves a basic concept of physics. It usually consists of one correct answer and other answers which are common misconceptions. Before discussion in small groups students have time to think about the question. There are different ways for students to commit to their answers before discussion: they can simply write the answer, use flashcards or some type of polling system. After the first poll, students discuss their answers and try to find the correct answer together with other team members. During discussion students teach each other. After the discussion more students choose the correct answer than during the first polling. Over the years, Peer Instruction has been used in different subjects and different levels of learning. More information about Peer Instruction can be found in [The Official Peer Instruction Blog, 2014] and [Mazur, 1997].

2. Case study

A case study is focused on the first implementation of the Peer Instruction method in Czech schools. Four teachers interested in this method implement it into their classes of Physics since a school year 2013/2014. They describe problems and highlight advantages connected to this implementation. Different educational levels are involved. Classes consist of approximately 25 students at the same age (at least 11 at most 19 years old). Lower and upper secondary schools are included. Peer Instruction is not used regularly; it is not the only method used during classes. All teachers involved in the case study have taught at least five years. They have learned about the method at workshops and they know basics steps of "how to implement the method into the classes." Websites about the method in Czech language with a database of questions for this method is available. Teachers discuss their questions and results during individual consultation or online by e-mail. Teachers have an opportunity to use electronic voting system and flashcards. They create their own questions or use prepared questions from an online database. Teachers plan how often to use the method and how many question to use in one class. During this study, students' pre-class preparation is not required.

In addition to describing “the first implement stories,” there are other research questions e.g. whether a polling tool affects learning, is there any difference in using a polling tool for the first answering and only keeping the answer in students’ mind, etc.

The results of this study can motivate other teachers to help students learn in more active way.

3. Database of ConcepTests

The ConcepTest, previously mentioned in the paragraph about Peer Instruction, is one of the key points of the method. One of the most important supports for teachers is creating good ConcepTests, which include common misconceptions as incorrect answer choices. A free online database of ConcepTests in Czech language is being prepared for teachers involved in the case study. 20 questions were prepared in the database at the end of first year of the implementation (12 question of mechanics and 8 questions of electricity). In the database, teachers can find different levels of questions (middle school, high school) and different topics of physics. The ConcepTests are ready to use in PowerPoint slides.

Some questions are ConcepTests translated from Eric Mazur’s book [Mazur, 1997] and the other part is based on the basic concepts research book [Mandíková, 2011]. The questions can be downloaded individually or in a file with the other questions on the same topic. Each question contains the correct answer and an explanation of misconceptions connected to incorrect answers. The database is in the Czech language.

4. Website about Peer Instruction

The database of ConcepTests is a part of a website about Peer Instruction. In this website, teachers can find basic information about the method, many tips from classes and other interesting resources e.g. links to video with Eric Mazur’s talk about Peer Instruction and assessment and videos from classes describing how to implement this method. All these videos are in English, so we are translating these videos and creating Czech subtitles [Peer Instruction, 2014].

5. Workshops and conferences

Supporting teachers to improve their classes we lead accredited workshops. These workshops usually take 90 minutes, they take place in different schools in the Czech Republic and they are free. The workshops are prepared for small groups of teachers (approximately for 12 teachers). The goal of these workshops is to present the method to teachers. During these workshops teachers can for example try the role of students at classes with Peer Instruction during these courses, which is very important for changing their teaching. Teachers at these courses answer questions using a polling tool, discuss answers in groups of peers and sometimes reveal and overcome their own misconceptions. Teachers discuss the advantages and disadvantages of each step of the Peer Instruction method. These courses were led 12 times during last four years. The method Peer Instruction and news in this area are also presented during national conferences for Czech Physics teachers, typically twice a year.

6. Tutorial

Mazur Group at Harvard University in Boston is creating the tutorial for teachers all over the world who want to learn about this method. Many interesting topics will be described, e.g. how to prepare before class, choose pooling tools, manage students’ discussions, find ConcepTests for your classes etc. Teachers who have questions about Peer Instruction can find answers there. This tutorial will be online and free. Knowing that for some teachers it is not possible to study in the English language, there is an opportunity to create different language translations, including Czech. Completion of English tutorial is planned for the year 2015. The author of this article was working for Mazur Group from January until May 2014 on this tutorial.

7. Conclusion

This article presents the support for Czech teachers which want to teach students using Peer Instruction e.g. creating ConcepTests, leading workshops etc. The future plan is to finish the case study of implementation the method to our schools. Results of study will show whether Peer Instruction can be used in our education and which advantages and disadvantages can be connected with this implementation. We want to continue with creating questions for the method and with leading workshops for teachers.

Acknowledgments

This work was supported by The Charles University Grant Agency (GAUK) under Contract1408213.

References

Crouch, C. H., Mazur, E. (2001). Peer Instruction: Ten years of experience and results. *American Journal of Physics*. Vol. 69, No. 9, pp. 970-977, ISSN: 0002-9505.

Mandíková, D, Trna, J. (2011). *Žákovské prekoncepce ve výuce fyziky*. Brno: Paido, 2011, 245 s. ISBN 978-80-7315-226-0.

Mazur, E. (1997). *Peer Instruction: A User's Manual*. Upper Saddle River, New Jersey: Prentice Hall, 1997, 253 s. ISBN 0-13-565441-6. In Czech.

Turn to Your Neighbor, *The Official Peer Instruction Blog* [online]. [cit. 2014-11-01] Available from: < <http://blog.peerinstruction.net/> >

Peer Instruction [online]. [cit. 2014-11-15] Available from: < <http://www.peerinstruction.cz/> >

Affiliation and address information

Jana Šestáková
Department of Physics Education
Faculty of Mathematics and Physics
Charles University in Prague
V Holešovičkách 2
180 00 Praha 8
Czech Republic
e-mail: Jana.Sestakova@mff.cuni.cz

How Does Epistemological Knowledge on Modelling Influence Students' Engagement in the Issue of Climate Change?

Giulia Tasquier
University of Palermo

Abstract

Involvement in climate change has been proven to be hindered by emotional and social barriers, as well as by conceptual difficulties that students may encounter in dealing with scientific content related to particular issues such as the greenhouse effect. In this study, we start from the conjecture that behind many conceptual difficulties and emotional barriers lie particular epistemological obstacles related to a naive and stereotypical view of science. These include, in particular, the belief that science still has the role and power to provide a unique, unquestionable, and certain explanation of events and processes. Such a naive idea clashes strongly with the intrinsic complexity of climate science. This paper sets out to investigate *if* and *how* the improvement of epistemological knowledge can influence behavioural habits and foster students' engagement in climate change. In order to explore such an issue, we focus on five interviews collected at the end of a teaching experience on climate change, carried out with secondary school students (grade 11; 16-year olds). This study is a follow-up of other two analytical studies aimed at investigating, respectively, the impact of the experience on students' epistemological knowledge and on their behavioural habits.

Keywords

Science education; Climate change; Secondary-school students; Epistemological competencies; Behavioural habits; Qualitative data analysis.

1. Framework and research questions

Involvement in climate change issues has been proven to be hindered by emotional and social barriers (e.g. Lorenzoni, 2007; Pongiglione, 2012; Weintrobe, 2012), as well as by conceptual difficulties that students can encounter in understanding the scientific content of the issue (e.g. Besson, 2010). Furthermore, climate change represents a demanding epistemological challenge for students and, more generally, for citizens (Pasini, 2003; Osborne & Dillon, 2008). Scientific debates on such a topic imply sophisticated epistemological argumentations which refer to the vital issue of the predictive power of climate models and to the crucial passage from classical deterministic models to non-linear complex ones. A large body of research demonstrates that students are not usually pressed to develop refined epistemological knowledge and that they achieve only a poor understanding of the nature of science (Pluta et al., 2011) and of what models are (Treagust et al., 2002; Koponen, 2007).

In our study, we made the conjecture that many conceptual difficulties and emotional barriers have their roots in naive and stereotypical beliefs about science – namely, that science still has the role and the power to provide a unique, unquestionable, and certain explanation of events and processes. Such a naive idea about modelling clashes strongly with the intrinsic complexity of climate science (Pasini, 2003; IPCC, 2007; Tasquier et al., 2015).

Based on this conjecture, we designed teaching materials where special emphasis was laid on the epistemological *fil rouge* of “models and the game of modelling”, and where students were guided to think about the epistemological implications of complex non-linear systems (Tasquier, 2014; Tasquier et al., 2015). The materials were implemented in a class of secondary school students (grade 11; 16-17 years old), over a total period of 15 hours. During the implementation many different data were collected to trace students' development along each of the three dimensions (Tasquier et al., 2015; Tasquier & Pongiglione, 2015; Tasquier, 2015). In particular, a fine-grained analysis allowed us to identify some markers to make visible *if* and *how* students enriched and refined their epistemological knowledge (Tasquier et al., 2015). The markers concern: *i*) the use of the vocabulary, i.e. the number and quality of epistemological words used by the students in writing and talking about physical phenomena and their modelling; *ii*) the patterns of argumentation used by students in talking about the Model-Experiment-Reality relationship. The marker data

highlighted a significant collective improvement in the quality of students' epistemological vocabulary and in the refinement of their argumentation patterns. The open issues, addressed in this paper as research questions, are: *Did the improvement of epistemological knowledge influence students' behavioural and social attitudes and their personal involvement in climate change issue? If so, how?* In order to answer these questions, the analysis focused on five students and the data collected through their individual semi-structured interviews, which include both societal/behavioural and epistemological questions. Prior to the presentation of the analysis, the context of the study is described.

2. Context

The teaching experience consisted of an after-school laboratory course held in a science-oriented Italian secondary school. The course involved one class of 28 students (grade 11; 16 year olds) and took place five times (table 1).

Table 13. Structure of the lab course

1 st	Introduction to climate change: scientific research and new terms of the scientific controversy (general climate science)
2 nd	Experiments on examples of interaction between radiation and matter (physics)
3 rd	Experiments for the construction of a Greenhouse Model (physics)
4 th	The epistemological perspective of complexity: Introduction to the basic concepts for investigating complex systems (mathematics & physics)
5 th	Political and Economic scenarios: overview of climate treaties and proposals to cut emissions (political, economic and sociological science)

The teaching materials designed and implemented in the course aimed to foster (Tasquier, 2013; Tasquier et al., 2014):

- Deep understanding of the basic concepts involved in global warming and climate change (*disciplinary dimension*);
- Critical thinking about the Man-Nature-Society relationship in order to acquaint students with past or current political and economic debates (*societal dimension*)
- Appropriation of a refined epistemological discourse where: *i*) controversies and scientific debates find legitimacy; and *ii*) modelling in climate change is discussed and progressively framed within the epistemological perspective of complexity (*epistemological dimension*).

Throughout the entire course, special attention was paid to developing an epistemological *fil rouge* in order to foster the progressive development of new and robust awareness about modelling, as well as about the causal schemes implied by different types of models and modelling (Tasquier et al., 2015). The *fil rouge* is briefly reported in table 2.

Table 2. Epistemological *fil rouge* throughout the lab-course

Lesson	Epistemological message
1 st	To look at real world phenomena, following a systemic, non-reductionist approach. Crucial concepts were: notion of feedback; space-time scale in Climate Science; the passage from deterministic to probabilistic models. (<i>The construction of global lenses</i>)
2 nd - 3 rd	To deal with the relationship established by the process of modelling between real world, lab experiments and theoretical knowledge. Students were guided to isolate a phenomenon, and identify its conceptual skeleton along with its potential for interpreting global change. (<i>Zooming in on isolated phenomenon</i>)
4 th	To introduce perspective of complexity so as to refine the epistemological discourse on Climate Science. Crucial concepts included: notion of feedback; time evolution and probabilistic nature of non-linear models; relation between individual and collectivity. (<i>The epistemological perspective of complexity</i>)

5th To use physical and epistemological skills in order to look at global change with a rational attitude. The complexity of natural phenomena was used both as mirror and metaphor of the societal complexity. (*Reading the world with our lenses*)

3. Methods

As already mentioned, many different data were collected at the beginning (B), at the end (E) and during (D) the whole teaching experience. The data sources were designed so as to take into account the different dimensions involved in the study (disciplinary - DD, epistemological - ED, societal - SD). Table 3 provides a map of the data sources and of the dimension that each source was intended to investigate.

Table 3. Data sources

MAIN DATA SOURCES	MOMENTS OF SUBMISSION			CHECKED/TESTED DIMENSION		
	B	D	E	DD	ED	SD
Pre-Questionnaire (Q ₁)	X			X	X	X
Questionnaire on the idea of model (Q _m)		X			X	
Post-Questionnaire (Q ₂)			X	X	X	X
Tutorials (group work)		X		X		
Audio-recording lessons		X				
Notes from researchers		X				
Written task inspired by inventory from EU research			X	X		
5 individual semi-structured interviews			X	X	X	X

Key: B: beginning of the path; D: during the path; E: at the end of the path; DD: disciplinary dimension; ED: epistemological dimension; SD: societal dimension

In order to answer the RQs (*Did the improvement of epistemological knowledge influence students' behavioural and social attitudes and their personal involvement in climate change issue? If so, how?*), we focused on the five interviews collected at the end of the teaching experience. The five students were chosen in order to represent different attitudes toward the activities. Student 6 (S6) represents a "shy" person in the class, he actively took part in the lab activities but he was not pro-active in the collective discussions; student 13 (S13) represents the "excellent" student of the class, he was much appreciated by the teacher and recognized by the classmates as a leader; student 16 (S16) represents the "sceptic" attitude toward climate change, he was not interested in the issue and demonstrated mistrust toward the activities; student 25 (S25) represents the "outsider" of the class, he was not particularly interested in the activities in general and also in the climate change issue; finally, student 26 (S26) represents the "thoughtful" attitude toward knowledge, he was very heedful but silent throughout the whole process. Table 4 provides a summary of the sample, aims of the interview and the protocol outline.

Table 4. Summary of interview features

Number of students	Five (4M, 1 F) ¹
Features of the sample	Heterogeneous group (the shy, excellent, sceptical, outsider and thoughtful class members)
When?	One week after the end of the teaching experiment
Aims	<ul style="list-style-type: none"> – To check conceptual understanding – To investigate students' idea of modelling in physics

¹ In order to guarantee anonymity, we will refer to all the students by using *he* or *him*, neutrally and regardless of actual gender.

- To gain feedback on how students experienced the lesson on complexity

Protocol outline

- **First part:** students' ideas about modelling in Physics
- **Second part:** students' ideas about the specific models addressed in the Climate Change path
- **Third part:** students' ideas about complex models

The graph of figure 1 sums up the changes of the five students along the epistemological and the behavioural dimensions as achieved in the previous analyses (Tasquier et al., 2015; Tasquier & Pongiglione, 2015).

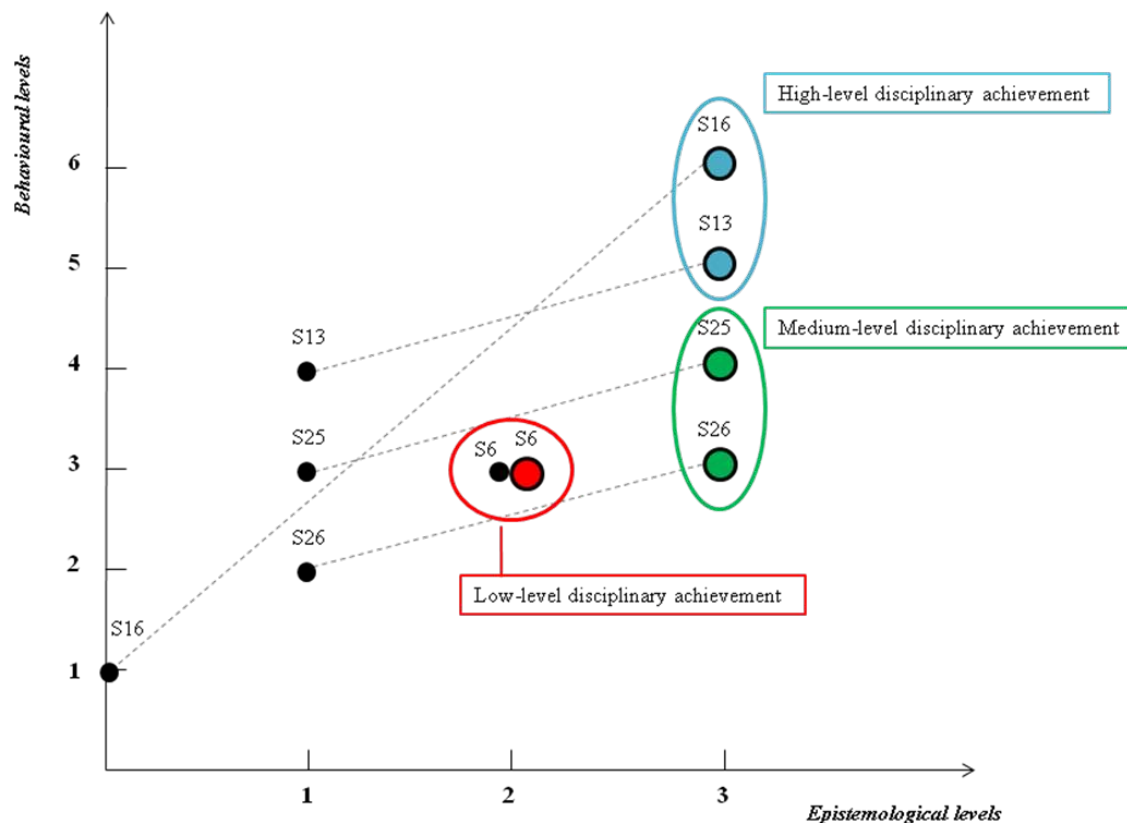

Figure 1. Students' changes along the dimensions

In the graph, the epistemological scale is on the x-axis (from 1 to 3). On this scale, the lowest level (1) is represented by a total lack of an epistemological language that leads students, for example, to identify a model with an experiment. The highest level (3) is represented by a mastery of epistemological arguments, which leads students to describe the relationship between models, experiment and reality as an iterative back and forth relationship. The behavioural scale on the y-axis represents different patterns of behaviour (from 1 to 6). On this scale, the lowest level (1) is represented by a lack of willingness to take action on climate change or change one's own lifestyle and habits in order to prevent climate change. The highest level (6) is represented by the willingness to take action or to change habits, together with a detailed explanation consistent with the content of the course. The black dots represent the position of the students at the beginning of the course and the coloured dots represent the position of the students at the end of the whole course; the different colours of the dots, in the final state, show the different level of disciplinary achievements. The graph shows that only S6 (*the shy*) did not change significantly in the epistemological and behavioural dimensions. Furthermore, he encountered strong difficulties with the disciplinary dimension.

Indeed, he was able to provide short answers to very specific questions with the help of the teacher, but he had difficulties in autonomously managing the basic physics concepts treated during the course. For instance, even at the end of the course, he was confused about the difference between emission and reflectance, and made mistakes when tackling the physical properties discussed in the course for interpreting the greenhouse effect. The other four students made visible changes along both dimensions of the graph and also achieved good results in the disciplinary dimension. In particular:

- S13 (*the excellent*) reached an excellent level of knowledge in the written task. He was the best in the class, even though he still had problems transferring what he learned in contexts differing from what was usually required by his teacher. He improved his epistemological knowledge on the Model-Experiment-Reality relationship. Regarding the behavioural dimension, the small improvement can also be attributed to the fact that he was already interested in the topic of climate change.
- S16 (*the sceptic*) achieved a high-level of disciplinary knowledge. Even though he did not achieve the best mark in the written task, like S13 he demonstrated a real ability to use the concepts of physics learned during the course for interpreting the greenhouse effect and its relationship with global warming. S16 was the student who demonstrated the biggest improvement in the epistemological and behavioural dimensions, despite the fact that the topics of climate change and, more in general, physics were initially very far removed from his personal interests.
- S25 (*the outsider*) reached a medium-level of physics knowledge. He understood the most important concepts in physics but he had some difficulties in managing the concept of emissivity. He showed a big improvement in the epistemological dimension and finally came to grasp the sense of the discourse about models and modelling. He had a medium-high improvement in the behavioural dimension, despite the fact that at the beginning the topic of climate change was very far removed from his field of interests.
- S26 (*the thoughtful*) reached a medium-level of physics knowledge. He understood the most important concepts in physics but he needed to talk about physics properties, like transparency, by relating them to the specific experiments carried out during the course. He showed significant improvement in the epistemological dimension and, regarding the behavioural dimension, he progressively changed his reasons why, in his opinion, few things could be done to prevent climate change. In this sense, he showed a significant improvement also along the societal/behavioural dimension.

In the light of such a map, the RQs become: *Is it possible to find correlations among the reactions of these students along the three dimensions? What general inference can be drawn from these cases?* The analysis of the interviews has been carried out to answer these questions.

4. Data analysis and results

Operationally, we decided to answer the RQs by analyzing students' interviews so as to design "profiles" of the students (Levrini et al., 2014). During the interviews, we observed significant differences among them. Some students were particularly involved and used articulated arguments, whilst other students had to be systematically encouraged by the interviewer. These different types of interaction revealed, in our opinion, two different kinds of reaction: some students felt embarrassed whilst others felt at ease and developed their arguments without any "pressure" from the interviewer. Such an impression has been captured in the following temporal maps that show the different pace and type of interaction between each student and the interviewer (Fantini et al., 2014). The participants and the silence are represented along the y-axis and each participant's talking time is represented along the x-axis (the time unit is two seconds).

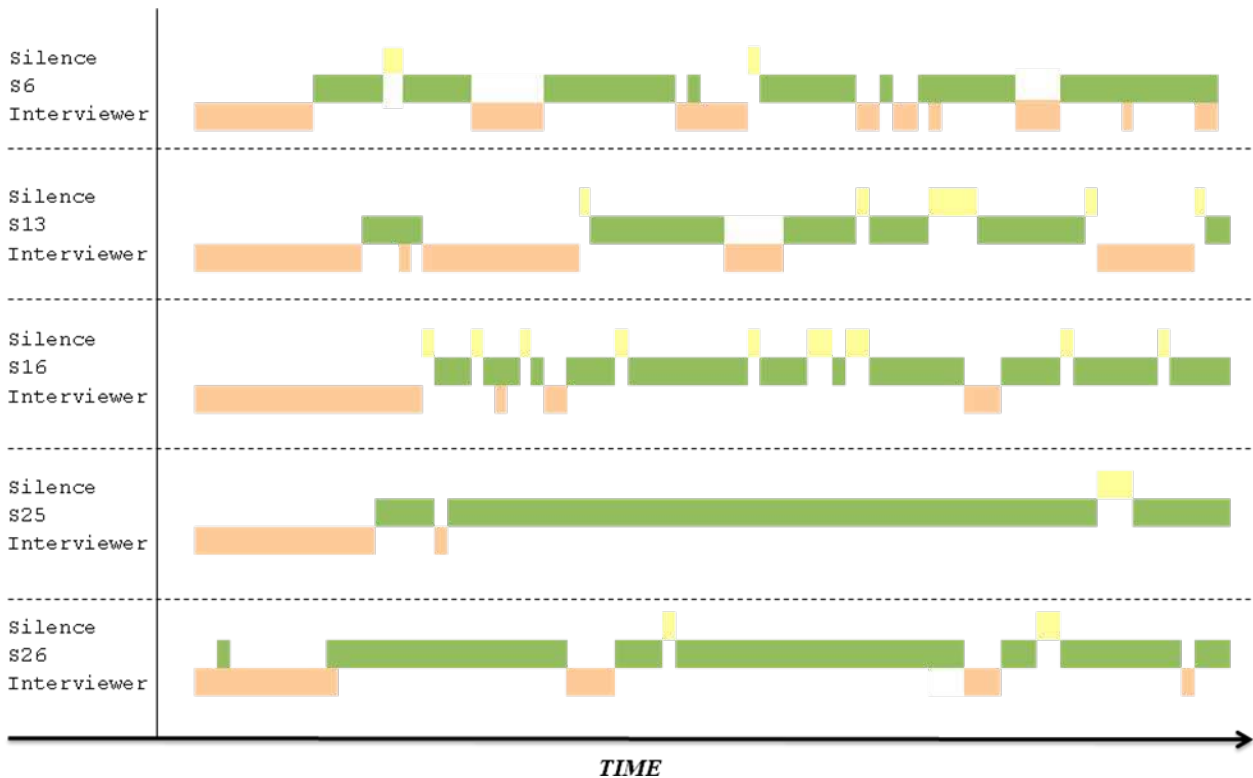

Figure 2. Excerpts of temporal maps from students' interviews (time unit: 2 seconds)

In order to make the maps comparable, they have been created using the same part of each interview, i.e. the first part. The pace of the discussion between the interviewer and student confirmed the impression that 3 students (S16, S25, S26) felt more at ease during the interview than the other two (S6, S13). Indeed, the first two maps show more frequent, interventions by the interviewer than in the others, even though the topic of discussion was the same.

Moreover, students' argumentations and their choice of words were significantly different. In particular, S16, S25 and 26 took the interview as an opportunity to express a main message about their experience in the course and, in the third part of the interview, each of them centred the argument on different key-words and terms related to the perspective of complexity. Our impression was that their use of specific words in the interview was representative of how they experienced the path on climate change and how the epistemological dimension touched both their scholastic attitude (as students) and behavioural attitude (as young citizens).

In the light of such considerations, we designed the profiles of S16, S25 and S26 as follows:

- (i) we took into account the *temporal map* of the single student in order to identify for each of them a specific pattern of interaction between the students and the interviewer;
- (ii) we identified the *main message* expressed by the student about his personal experience in the course;
- (iii) we identified *words or expressions* that each student repeated several times during the interview to express and articulate their main message.

As will be shown, comparison of the three profiles allows us to produce a draft argument to answer the RQs. The draft argument will be tested and refined against the cases of S6 and S13, which appear significantly different from the previous three cases. Besides the different pace of the interviews, in the transcripts of S6 and S13 it was neither possible to identify the emergence of a main central idea, nor to identify words or expressions related to the complexity that had captured their attention. The profiles of students S6 and S13 were built so as to further explore the credibility of our argument and to outline its limit of validity (Anfara et al., 2002). In this sense, S6 and S13 acted as contrastive cases.

S16: “The sceptic”

(i) *Temporal map*. During the interview, S16 appeared at ease from the outset. Although there were several moments of silence, there were only few and short interventions by the interviewer. Particularly, the moments of silence seem to be important moments of reflection, functional to the discourse. In this sense, the map shows that S16 was constructing his discourse and the interviewer allowed him time to do this.

(ii) *Main message*. From the very beginning of the interview, S16 told us that before the course he had been sceptical about the issue of climate change and the scientific reliability of information provided by the media. He expressed the need to have correct and solid information in order to avoid being manipulated by the media. The alarmism that, in his opinion, characterizes the way in which this subject is often treated, does not represent a guarantee of the real existence of global warming. His position later evolved as a result of the whole course and particularly thanks to the introduction of the perspective of complexity and of the features of modelling of complex systems. In particular, the model of Schelling was an element that led him to activate the societal dimension, which was initially absent: “*Let's say that before I knew little on the subject, because at the beginning this was not a topic of interest for me. But as these meetings went on, providing more information, I arrived at the understanding that these are instead important topics that must be followed and they are in fact interesting. [...] Before that course, I thought it was all just huge alarmism and nothing else*”.

(iii) *Key words*. In the interview, S16's discourse was strongly characterized by the repetition of words like *to determine exactly, regularity, to know exactly*. These are words that he systematically used in every part of the interview and that seem to express his need to know exactly what happens. In the following excerpts, for instance, S16 explains how the Lorenz attractor has revolutionized his idea of “the determination of the behaviour of a body”: “*[in classical physics] I can determine where it will be at a certain point after a certain period of time, whilst here [in the Lorenz's butterfly] I cannot do that. Here it is impossible, I know where such a point moves but I cannot know exactly where it is now. Whereas before the course I was convinced that there was only classic physics, in this case the whole situation has reversed ... and I was a little bit disoriented but fascinated*”. Consistent with his view, the word of complexity around which he developed his reasoning was *unpredictability*. Indeed, when the interviewer asked S16 about the words and concepts that he found more interesting or that changed his perspective, S16 claimed: “*Surely 'unpredictability'; let's say that all the other words of complexity, I think, serve to explain this word ... let's say that the most important word is 'unpredictable' because with this word I explain what it means to study phenomena on a global scale*”. In order to give credibility to the issue of climate change, S16 expressed a need to elevate unpredictability to the rank of a scientific concept and to attach a more refined meaning to the provisional power of science and the kind of data and models on which science founds its previsions: “*I realized that, for example, the melting of glaciers and a rise of just one degree of the average temperature, can lead to important consequences. I understood that these things need to be evaluated on a very dilated scale of time. Whereas I was initially convinced that the data variation from year to year was enough to understand these things [changes in the climate], instead I understood that we must have data based on years and years of experience*”.

S25: “The outsider”

(i) *Temporal map*. During the interview, S25 appeared very at ease. In the excerpt below there was only a moment of silence and only within S25's discourse, to indicate a moment of reflection. Hence, it seems that he was ready to articulate his discourse.

(ii) *Main message*. During the interview, the main message which emerged is that, despite the difficulty of the subject and of physics in general, the game of modelling and the progressive complexification of models offered S25 a key to address the topic. Particularly, the lesson on complexity was a fundamental moment in his learning path because it represented an intellectual challenge that he decided to take up. Furthermore, the perspective of complexity allowed him to analyze a scientific issue from multiple points of view, and to form a global and coherent picture. At the end of the interview, S25 revealed that he was a musician and that he loved art and math, whilst he was not particularly interested in science: “*The lesson on complexity was particularly interesting, i.e., more than anything else, it was like a challenge, so I said 'okay, let's try to figure it out'. Then it was nice to find out how to go from a laboratory model of a virtual model, imagine how they might go, if everything goes as we imagine things; how things could go in space, or in a place connected to us. That is to say, it is nice to know and to be able to predict some things*”.

(iii) *Key words*. S25 did not select only one word of complexity around which he organized his discourse. He was fascinated by all the words of complexity and their evocative power. During the lesson, he was guided by the charm that those words evoked and he tried to collect all the stimuli that the new perspective of complexity transmitted to him. The fascination for the aesthetical dimension that stimulated his interest dominated his whole interview. In commenting on the course, he focused on a picture of the Dutch graphic artist M.C. Escher, which was used as a cover page for the lesson on complexity. S25 gave the picture a special significance in explaining the idea of global and local view, the difference between macro and micro, and the concepts of regularity/irregularity and order/disorder.

He revealed that at the beginning of the project, he was bored by the idea of dealing with climate change. The *fil rouge* on modelling and the lesson on complexity were the two elements that captured his attention and that initially attracted him to the issue. The aesthetical dimension and, in particular, the new and more fascinating perspective on science introduced by the lesson on complexity represented a way to engage such a student. Particularly, in the perspective of complexity he found an opportunity to study science in a game between freedom and constraints in which creativity can also play a role, just like for a painter or musician.

S26: “The thoughtful”

(i) *Temporal map*. During the interview S26 appeared at ease. He was able to take responsibility for his answers. He managed the discourse by himself with pauses when necessary, even though he sometimes needed some minor assistance from the interviewer.

(ii) *Main message*. S26 immediately explained that he needed to address every issue in a practical and concrete way: “*The laboratory experiments were clear and explicit. However, in my opinion, it is easier to learn by doing things rather than just by listening. [...] Indeed, I better understood the issue of models when I made models by myself, by seeing and creating them, and also thanks to the tutorial that was given to us during the experimental lessons*”. His need to learn by doing was not only related to the lab-activities but also to the implementation of computer-designed models. S26 was also really attracted by the computational aspects of modelling, indeed he was interested in the way Lorenz concretely elaborated his theory.

(iii) *Key words*. Throughout the whole interview there was the recurrence of the words “complicated” and “complex”

which at the beginning of the interview were used alternately in a confused way. In our opinion, his sentences revealed a more or less conscious need to find a way to distinguish what is complicated, and then reducible to something simpler, as opposed to what is complex, then non-reducible. In coherence with his linguistic style, he chose “irreducibility” as the most evocative word of complexity, around which he organized his thoughts: “*Well, irreducibility is the word that I better understood [...] irreducibility in the sense that there are things that cannot be reduced to only one parameter, as we saw in the example of the iteration of Lorenz ... when he inserted his values into the computer and then cut some significant digits, then he had a different situation from what he expected ... there is a limit to the simplification*”.

S26 overcame the idea that “irreducibility” was a limitation or something which was possible to solve thanks, for instance, to advanced technology, or something that was possible for him to unravel. Instead, “irreducibility” became an implicit feature of the nature of certain phenomena. Thanks to this development in his thinking, he matured in his awareness both of this topic specifically and also more generally about science. However, this process is still underway at the time of the interview. The conflicting use of the words “complicated” and “complex” is proof of this. This conflict was positively managed, indeed the interview helped S26 to progressively recognize the distinction between the two words and to change his way of looking at the relationship between the individual and the solution. Such a distinction has an important role in defining the shift of perspective from the classical models to complex models: from an initially very pragmatic approach to the awareness needed in a more complex and non-reductionist approach in searching for solutions.

5. Discussion of the first set of profiles

Through the comparison of the three profiles, we can infer examples of *functions* played by the epistemological dimension in triggering an attitudinal change toward climate change.

For S16, the epistemological dimension served to nurture his intellectual interest by providing a sort of “scientific reliability” to any discourse about climate change. In particular, the elevation of unpredictability to the rank of a scientific concept allowed him to overcome his initial scepticism and to find room for a

personal social involvement. As for S25, the charm of the epistemological dimension functioned as an attractor capable of nurturing his aesthetic pleasure. Indeed, the challenging character of said dimension touched his artistic personality and triggered the activation of a social involvement. For S26 at least, the epistemological dimension acted as a key i) to overcoming the personal barriers created by his pragmatism which prevented him becoming involved in something too complicated; and ii) for tackling scenarios with new possible and reliable, even though more complex, methods of thinking.

To sum up, the draft answer to our RQs is as follows: the epistemological dimension and, in particular, the perspective of complexity was, in some cases, productive in triggering a change in students' attitude towards climate change. The examples show a spectrum of three different specific functions that it played: to provide scientific reliability, to infuse intellectual charm to the discourse, to extend the field of possible actions. These functions are, of course, idiosyncratic and we suppose that many other functions could be found if we enlarged our empirical basis. Nevertheless, our three cases alone allow us to conclude that significant correlations can be found between the epistemological and behavioural dimensions and that the teaching path was able to create, for some students, a virtuous dynamic state among them.

The two cases that we will consider now provide further contributions to understanding why that happened with these students and why it failed with others.

S6: “The shy”

The interview was dominated by very short answers from the student and by many pauses with the frequent use of expressions like “*ehm*”. S6 systematically needed the interviewer's help in articulating his thoughts. From the beginning, this student stated that his attention was focused on things he found “easy”, such as the experiments. For him the lesson on the perspective on complexity represented an intellectual obstacle that he did not even try to address.

His interview discourse was fragmented and not articulated enough to enable us to evaluate to what extent his thinking was globally consistent from the points of view of disciplinary content and epistemological message. Indeed, he listed the words of complexity, simply saying that he did not understand them and that he did not relate the first part of the course to modelling with the perspective of complexity: “*What caused me difficulty was the circular relationship and then the non-linear causality ... ehm ... I cannot connect it to the idea of complexity*”. Within his discourse it is not possible to identify the presence of a core idea around which he organizes his thoughts. The poorness of the discourse leads us to conclude that S6 found the path too difficult. This student reacted with occasional short answers that do not reveal any attempt to find a personal method to understand the content. This is demonstrated by the recurrence of the expression “*I did not understand*”.

He ended the interview by saying that he was happy to have tackled this “modern environmental problem” because he trusted his teacher but that the difficulties he met with the content prevented him from following the epistemological and societal *fil rouge*.

S13: “The excellent”

From the very beginning, the embarrassment of S13 is evident. From the map and the short and fragmented answers he provided, we can see that he did not feel at ease. S13 systematically needed the help of the interviewer in articulating his discourse.

Looking at the other data collected from this student, it emerged that he reached top levels in each dimension (see figure 1). He understood the scientific discourse (the concepts of absorbance, transmittance, reflectance and the greenhouse mechanism). He managed the discourse on models well (up to the lessons of the laboratory) and he also changed some aspects of his behaviour. Despite such results, he showed many difficulties during the interview and the tone revealed a sort of “cold acceptance”. Why did this happen? One reasonable explanation for his blanket of embarrassment is provided by the student himself at the beginning of the interview, when he stated very clearly that he did not understand the link between the epistemological perspective of complexity and the rest of the course: “*More than anything else I do not understand the relationship that exists among: the models, what we did in the laboratory and the complexity*”. His failure to link the different parts of the course seems to show that he accepted the path in all its parts but did not feel the need to form a personal view. Unlike the first group of students, it is not possible to find key-words or a central message in his interview.

The words he offered during the interview are not enough to provide a unique interpretation of the reasons for his reactions. The hypothesis that we find most convincing is that he approached the course in a scholastic way, in the sense that he expected to be spoon-fed the connections by the teacher as opposed to

forming a personal view of the content and taking responsibility himself for acquiring the knowledge (Cornelius & Herrenkohl, 2004).

During the interview we perceived that he felt discomfort at being removed from an ordinary teacher-student situation and, thus, without the traditional rules of a common oral task (Brousseau, 1986; Yackel & Cobb, 1996). S13 limited his personal involvement in the epistemological and emotional dimensions probably because he wanted to keep under control his insecurity towards the apparently novel scholastic context. Still, as is evident from the beginning, he did not accept entirely the existence of an epistemological dimension, particularly the existence of an intrinsic complexity in the nature of science. Even though he grasped the scientific meaning passed on by the course, the inner epistemological debate about climate change hindered him in tackling a new emotional challenge.

6. Discussion of the two contrastive cases

Comparing the two contrastive cases with the previous results allows us to refine our draft argument and our answer to the RQs. In particular, the comparison leads us to identify some boundary conditions that are needed to trigger a personal and conscious involvement in climate change issue. From the analysis of S6's profile, it emerges that the first condition is the importance of meaningful learning of scientific content. In our course, the epistemological and behavioural dimensions are deeply rooted in the discipline and, without a significant learning of the basic concepts of physics, the other dimensions become meaningless. From the analysis of S13's profile, a second condition emerges, regarding the freedom of a social role that the student has to play (related to the expectations of his teacher and classmates). Indeed, S13 was the "excellent" member of the class and it seemed as though he had to defend this role for his self-efficacy (Bandura, 1994). His social interest toward the topic seems to be still effectively dependent on his teacher (Cornelius & Herrenkohl, 2004). On the contrary, in the first three profiles, we saw that they felt free to express their personality without behavioural constraints, they were free also to be initially sceptic and to follow a personal path of learning and view-forming.

7. Conclusion and final remarks

The analysis presented in this paper is part of a wider investigation into the reaction of secondary school students to a multi-dimensional path on climate change. The project aimed to foster behavioural and personal involvement through a refined epistemological reflection on modelling and on the perspective of complexity. In order to investigate possible links between the epistemological competences and the behavioural attitude toward climate change, five students were selected and analyzed. The analysis highlighted different types of emotional reaction to the epistemological dimension: the general acceptance was coloured with enthusiastic intellectual satisfaction by some students, with "cold" acceptance, or with a prudent and responsible curiosity by others. The various types of reaction seem to have interesting links with students' emotional and social attitude toward climate change. Three cases concern students who had an initial distrust or resistance toward climate change issues and found personal new reasons for engagement in the epistemological perspective of complexity. Two of them found, in the epistemological dimension, a stimulating opportunity to nurture their intellectual or artistic talent. One (more pragmatic) found new arguments to see and evaluate possible directions of action. The other two students acted as contrastive cases and allowed us to see some boundary conditions needed to trigger personal involvement. These conditions regard the need to master disciplinary knowledge in order to recognize the value of the epistemological and social dimensions and the importance of feeling free from the teacher's expectations before being able to explore and find one's own position with respect to such complex issues. In the light of these results, we can assert that, under certain conditions, specific epistemological know-how can positively impact not only productive disciplinary engagement, but also a more personal and authentic involvement in climate change. However, the analysis of the two contrastive cases raises two open issues. The first one concerns the domain of validity and the problematic issue of searching for the boundary conditions that foster and support authentic behavioural responses. The second concerns the role, well-known in literature, of the external expectations (from a teacher or other people) in fostering or hindering proper, authentic and genuine involvement.

References

Anfara, V. A., Brown, K. M., & Mangione, T. L. (2002). Qualitative Analysis on Stage: Making the Research Process More Public. *Educational Researcher*, 31(7), 28-38. doi: 10.3102/0013189X031007028.

- Bandura, A. (1994). Self-efficacy. In V. S. Ramachaudran (Ed.), *Encyclopedia of human behavior* (Vol. 4, pp. 71-81). New York: Academic Press. (Reprinted in H. Friedman [Ed.], *Encyclopedia of mental health*. San Diego: Academic Press, 1998).
- Besson, U., De Ambrosis, A., & Mascheretti, P. (2010). Studying the physical basis of global warming: thermal effects of the interaction between radiation and matter and greenhouse effect. *European Journal of Physics*, 31, 375-388.
- Brousseau, G. (1986). Fondaments et méthodes de la didactique des mathématiques. *Recherches en didactique del mathématiques*, 7, 2, 33-115.
- Cornelius, L.L., & Herrenkohl, L.R. (2004). Power in the Classroom: How the Classroom Environment Shapes Students' Relationships With Each Other and With Concepts. *Cognition & Instruction*, 22(4), 467-498.
- Fantini, P., Levin, M., Levrini, O., Tasquier, G., (2014). Pulling the rope and letting it go: analyzing classroom dynamics that foster appropriation. In C. P. Constantinou, N. Papadouris & A. Hadjigeorgiou (Eds.), E-Book Proceedings of the ESERA 2013 Conference: Science Education Research For Evidence-based Teaching and Coherence in Learning. Part 7 (co-eds. Evagorou, M., & Iordanou, K.), pp. 142-153. Nicosia, Cyprus: European Science Education Research Association (ESERA). ISBN: 978-9963-700-77-6.
- IPCC (2007). Climate change: Synthesis Report.
- Koponen, I.T. (2007). Models and Modelling in Physics Education: A Critical Re-analysis of Philosophical Underpinnings and Suggestions for Revisions. *Science & Education* (2007) 16:751_773, DOI 10.1007/s11191-006-9000-7.
- Levrini, O., Fantini, P., Pecori, B., Tasquier, G., & Levin, M. (2014). Defining and operationalizing 'appropriation' for science learning. *Journal of the Learning Sciences*. DOI:10.1080/10508406.2014.928215
- Lorenzoni, I., Nicholson-Cole, S., & Whitmarsh, L. (2007). Barriers perceived to engaging with climate change among the UK public and their policy implications. *Global Environmental Change*, 17; 445-459.
- Osborne, J., & Dillon, J. (eds) (2008). Science Education in Europe: Critical Reflections. A Report to the Nuffield Foundation. Retrieved from: http://www.nuffieldfoundation.org/sites/default/files/Sci_Ed_in_Europe_Report_Final.pdf
- Pasini, A. (2003). *I cambiamenti climatici. Meteorologia e clima simulato* [Climate Change. Meteorology and simulated clima]. Milano, IT: Bruno Mondadori press.
- Pluta, W.J., Chinn, C.A., & Duncan, R.G. (2011). Learners' Epistemic Criteria for Good Scientific Models. *Journal of Research in Science Teaching*, Vol. 48, No. 5, pp. 486-511.
- Pongiglione, F. (2012). The key role of causal explanation in the climate change issue. *Theoria – An International Journal of Philosophy of Science*, 74, 27/2.
- Tasquier, G. (2013). Cambiamenti Climatici e Insegnamento/Apprendimento della Fsica: una Proposta Didattica [Climate Change and Teaching/Learning Physics: a Teaching Proposal]. *Giornale di Fisica*, vol. LIV, n. 3, 54 (03), 173-193.
- Tasquier, G. (2014). A multi-disciplinary approach to Climate Change. E-Book Proceedings of the ESERA Conference 2014, Cyprus 2-7 September 2013.
- Tasquier, G. (2015). Leading secondary school students to face the disciplinary, epistemological and societal challenges of climate change: design and analysis of multi-dimensional teaching/learning experiences. *Phd Thesis*.
- Tasquier, G., Levrini O., Dillon J. (2015). Exploring Students' Epistemological Knowledge of Models and Modelling in Science: Results From a Teaching/Learning Experience on Climate Change. *Submitted to the International Journal of Science education* (paper under review).
- Tasquier, G., Pongiglione, F., & Levrini, O. (2014). Climate change: an educational proposal integrating the physical and social sciences. *Procedia - Social and Behavioral Sciences*, 116, 820-825. doi: 10.1016/j.sbspro.2014.01.304.
- Tasquier, G., & Pongiglione, F. (2015) (*pre-print*). Correlation between knowledge and behaviour related to climate change issue.
- Treagust, D., Chittleborough, G., & Mamiala, T. (2002). Students' understanding of the role of scientific models in learning science. *International Journal of Science Education*, 24, 357-368.

Weintrobe, S. (2012). *Engaging with climate change: Psychoanalytic and Interdisciplinary Perspectives*. Routledge.

Yackel, E., & Cobb, P. (1996). Sociomathematical Norms, Argumentation, and Autonomy in Mathematics. *Journal for Research in Mathematics Education*, 27(4), 458-477.

Affiliation and address information

Giulia Tasquier
Department of Physics and Chemistry
University of Palermo
Viale delle Scienze, ed. 18
90128 Palermo, PA, Italy
e-mail: giulia.tasquier@unipa.it

An Open Inquiry Research-Based Teaching-Learning Sequence about the Cause of Seasons

Italo Testa¹, Gianni Busarello², Silvia Leccia², Emanuela Puddu², Arturo Colantonio³

¹ *Department of Physics, Federico II University of Naples*

² *INAF – Astronomic Observatory of Capodimonte*

³ *Liceo Scientifico Medi, Cicciano, Naples*

Abstract

In this paper we describe an inquiry-based module aimed at explaining the physical mechanisms underlying the astronomical phenomenon of seasonal changes. In the module's activities, radiation flow and energy transfers are quantitatively measured by the students in simplified situations to construct the models that account for evidences related to the seasons. The module has been implemented with 45 secondary school students (17-18 years old). Analysis of students' answers to the pre- and post-test questionnaires supports the effectiveness of the proposed activities.

Keywords

Seasons, inquiry, secondary school

1. Introduction

Physics education research has thoroughly showed that students encounter many difficulties in understanding the causes of seasons (e.g., Atwood & Atwood, 1996; Baxter, 1989; Sharp, 1996; Starakis & Halkia, 2014). Most common incorrect explanations range from the naïve idea that when the Earth is closer to Sun it is summer, to the more sophisticated, but still incorrect, idea that the Earth's axis flips back and forth during the motion around the Sun. Still, seasons are a meaningful context to familiarise students with up-to-date topics as climate changes. Moreover, the historical evolution of the explanation of the change of seasons may illustrate to students how scientists challenge existing models to improve their understanding of a natural phenomenon (Sneider, Bar & Kavanagh, 2011). Hence, many teaching proposals aimed to improve students' understanding about this topic can be found in literature (Küçüközer, 2008). However, in most of these proposals, the physical mechanisms remain often hidden and not clarified to students.

To address this issue we developed an inquiry-based module about change of seasons. Inquiry is acknowledged as central in science learning since long time (NRC, 1996). Research shows that students may achieve a deeper understanding of science contents when they are involved in inquiry activities (Blanchard et al., 2010). Moreover, inquiry can foster young students' motivation (Mistler-Jackson & Songer, 2000) and scientific reasoning (Metz, 2000). When learners are engaged in inquiry activities, they are faced with open-ended challenges wherein new scientific knowledge would be developed. Inquiry activities are essentially student-centred and focus on improving abstraction, modelling and communication skills. Finally, inquiry approach may also facilitate the introduction of basic aspects of Nature of Science as, for instance, the relationships between experimental evidence and theoretical models or the testing of hypotheses.

In our module, scientific inquiry approach is implemented through the following steps: (i) to hypothesize which are the main factors underlying the change of seasons; (ii) to design an experiment to collect evidence to support their hypotheses; (iii) to interpret the obtained experimental results by means of simple mathematical relationships; (iv) to revise the initial hypotheses and construct a coherent explanation for the change of seasons.

2. Rationale of the module

At a qualitative level, seasonal changes are due to two main factors: the inclination of the Earth's axis with respect to the orbit's plane and the revolution of the Earth around the Sun. At a more quantitative level, the tilt of the Earth's axis and the different positions of the Earth result in a different sunrays flow on Earth

surface during the year. To give full account for the temperature changes during the year at a given place on Earth, the different length of the day and the influence of local climate factors (as, for instance, the presence of water, soil, and winds) have also to be considered. Actually, many research studies (see reviews by Bailey & Slater, 2004; Lelliott & Rollnick, 2010) have shown that traditional teaching activities, which often simply itemize the above factors, are not effective in addressing the intuitive idea that the changing distance between Sun and Earth is the most important factor underlying this phenomenon. How students come to this intuitive idea may be explained by everyday experience with heat sources, and by the difficulty in estimating the distance variation between Sun and Earth during the year (about 3%). Another possible explanation is that students may find difficult to relate the “energy” received by the Earth and the different conditions under which solar light hits the Earth’s surface (Galili & Lavrik, 1998).

To provide a basic idea of the main physics mechanism underlying the cause of seasons, including local temperature changes, our module focuses on two key ideas: radiation flow and energy transfers. In particular, the basic idea of our module is to quantitatively show how the flow on a given surface depends on: (i) the angle between the normal to the surface and the direction of the incident radiation; and, (ii) the distance between the surface and the source. In the first case, students can model the variations of sunrays flow at a fixed time of the year over the entire Earth surface leaning towards the Sun or, equivalently, at a fixed place on the Earth’s surface as our planet completes its revolution around the Sun. In the second case, they can model the variations of sunrays flow when the Earth has the maximum and minimum distance from the Sun. The main didactical aim is to provide students with evidence that greatly contradicts naïve reasoning schemas based on the distance misconception. Then, having shown the relevance of the tilted axis with respect to the small eccentricity of the Earth’s orbit on the change of seasons, it is possible to address why places of the Earth at the same latitude experience very different average temperatures over the year. To this aim, to provide the students with simple evidence about the relevance of the factors that affect a given region climate (for example, presence of water and soil), it is possible to show how heat transfers depend on the substances involved in a thermal interaction.

3. Activities of the module

The module is divided into four activities, which we describe in the following paragraphs reporting also typical students’ responses. All activities are supported by worksheets.

3.1 Introductory activity (4 hours)

In this activity the students, in small groups, are asked to define what is a season and how do they know that we are in a certain season. The question “*what are the main factors that influence change of seasons?*” is raised in order to elicit naïve conceptions about change of seasons (e.g., the distance misconception). Examples of students’ possible responses are:

“The factors that influence the change of seasons are the variations of temperature due to the changing distance between the Earth and the Sun”.

“The seasons depend on the motion of revolution of the Earth and on the inclination of the Earth: during the perihelion the inclination of the Earth is such that the sunrays hit its surface so that it is summer in austral hemisphere and winter in the boreal one; while during the aphelion, it is the contrary”.

“The change of seasons is due to the motion of revolution of Earth which modifies the inclination of the Earth’s axis. The different inclinations cause the different inclinations of the sunrays on Earth’s surface”.

Then, the students are asked what would be the effect on seasons changes of the absence of the identified factors. The aim is to investigate the coherence of the students’ initial explanations about seasonal changes. Possible students’ responses may be:

“If the Earth would not rotate around the Sun, there would be always the same season or the same temperature”.

“If the Earth’s axis would not be inclined, we would have fixed temperatures”.

“If the Earth’s orbit would not be elliptical, we would have no seasons”.

“If the Earth’s axis would change direction we would experience more seasons”.

After a class discussion about students’ responses, it is asked to design a simple experiment, using a list of available materials, to show the role of the identified factors on the change of seasons. The aim is to

investigate whether the students can relate the identified factors with physical quantities that can be measured. The teacher may focus solely on two factors, as the inclination of the Earth's axis and the changing distance between Earth and Sun. A possible experiment proposed by the students is the following:

"I would use a light in the focus of an ellipsoid, a plastic globe covered with a photosensitive material and I would measure the light intensity when changing the distance between the globe and the light and the inclination of the globe's axis with respect to the Sun's axis".

3.2 Experimental activity about the radiation flow (4-6 hours)

In this core activity of the module, the students investigate the relationship between the different quantity of solar radiation received by a specific location on Earth during the year and the two factors identified in the previous activity, the tilt of the axis and the distance from the Sun. The students are told that radiation flow is a power per surface unit and hence it can be measured through a device that transforms the intensity of received light into a potential difference. A photovoltaic panel¹ and an incandescent light bulb (a laboratory "Sun") are used. Before performing the experiments, the students predict what would be the trend of the measured power when the incidence angle and the distance are varied. Examples of predictions are shown in Fig. 1a and 1b.

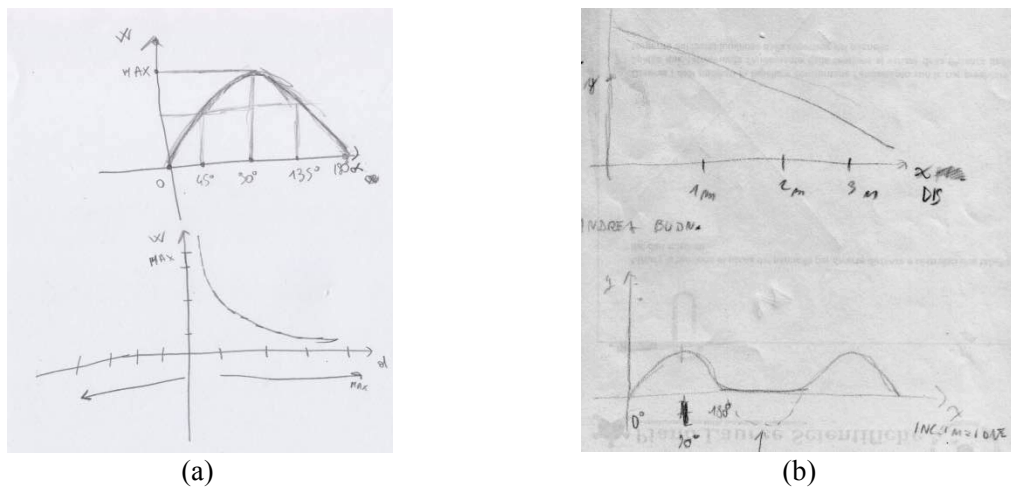

Figure 1. Students' predictions about the relationships between light intensity and the incident angle on the panel surface and the distance between the source and the panel (a) correct (b) incorrect.

Then, the students measure the output voltage of the panel as its inclination with respect to a given reference system and its distance from the source change with the setting of Fig. 2a and 2b.

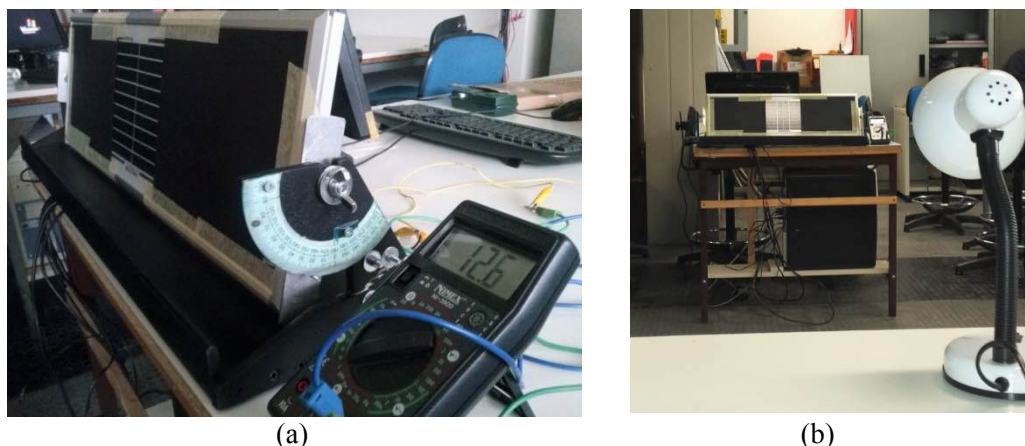

Figure 2. Experimental setting used for the measurement of the light flow on a solar panel according to (a) the incident angle, (b) the distance between the source and the panel. The sensible area of the panel is about 200 cm^2 , the distance between the light lamp and the center of the panel ranges from 120 to 310 cm.

¹ During the activity, the panel has been described to students as a constant current generator. To ensure that the output power was proportional to the incoming one (linearity interval), loads of resistance from $0.9 \text{ k}\Omega$ to $0.1 \text{ k}\Omega$ have been used by the students as loads of the panel.

After comparing the predictions and the obtained measurements, the teacher may guide students to represent the data as in Fig 3 and 4. Particular emphasis is put on what would be the mathematical function that best fit the collected data. Depending on the pupils' school level, the teacher may deepen the mathematical behaviour of the best fit functions.

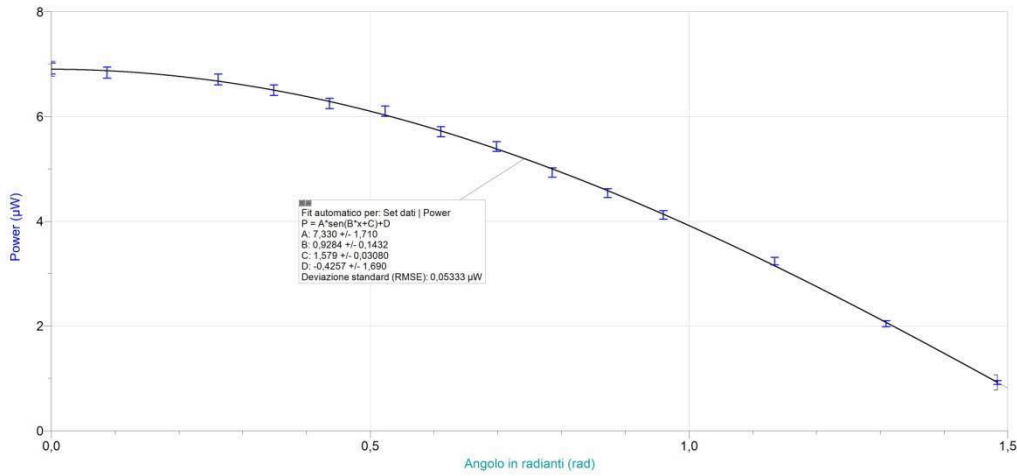

Figure 3. Output power of the panel lighted by a 100W incandescent lamp as a function of the inclination between the normal to the panel and the direction of the radiation. The fit gives: $P(\theta) = A \sin(B\theta + C) + D$, with $A = (7.3 \pm 1.7) \mu W$; $B = (0.93 \pm 0.14) \text{rad}^{-1}$; $C = (1.58 \pm 0.03) \text{rad}$; $D = (-0.4 \pm 1.7) \mu W$.

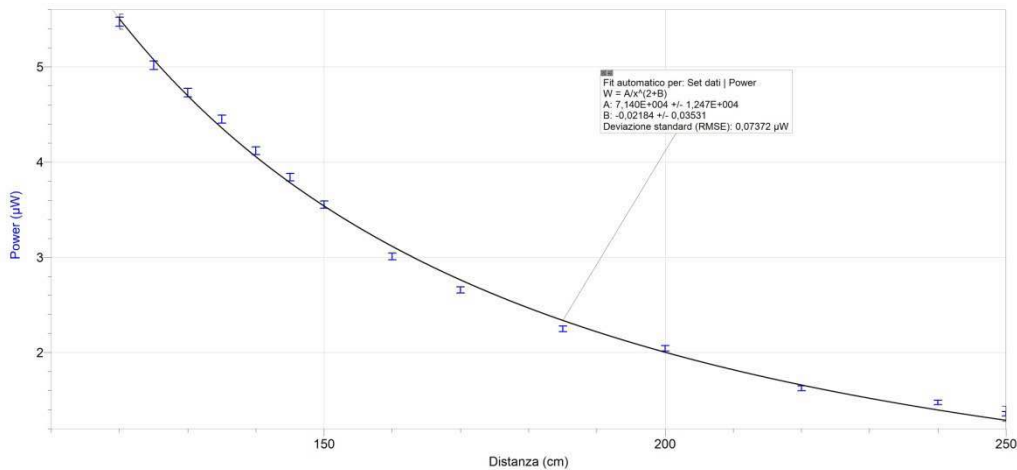

Figure 4. Output power of the panel lighted by a 100W incandescent lamp as a function of the distance between the centre of the panel and radiation source. The fit gives $P(D) = \frac{A}{D^{2+B}}$ with $A = (7.1 \pm 1.2) \mu W m^2$; $B = (0.02 \pm 0.03)$.

Finally, simplified laws for the power received by the panel are presented to students (equations (1) and (2)). P_0 is the power received by the panel when the angle θ between the normal to the surface panel and the direction of the incident radiation is 0, and A is a dimensional constant that takes into account the geometry of the sensible area of the panel and the power emitted by the source.

$$\frac{P(\theta)}{P_0} = \cos(\theta) \tag{1}$$

$$P(D) = \frac{A}{D^2} \tag{2}$$

3.3 Modelling activity (4 hours)

Using equations (1) and (2) the students first evaluate the incident radiation flow at four times of the year (spring and autumn equinoxes, summer and winter solstices) at five specific places on Earth (Arctic and Antarctic circle; Cancer and Capricorn tropic; Equator) using the information of printed images constructed with Cabri Géomètre (Fig. 5). Contrarily to usual teaching about the topic, during the activity, a great portion

of time is devoted to link 2-d textbook representations to the real Earth and Sun system through the Cabri Géomètre representations. The aim is to guide the students to understand that, for a given place, the different angles reported in the textbook images result from the fact that the Earth's axis always points in the same direction and from changes in the position of the Earth along its orbit.

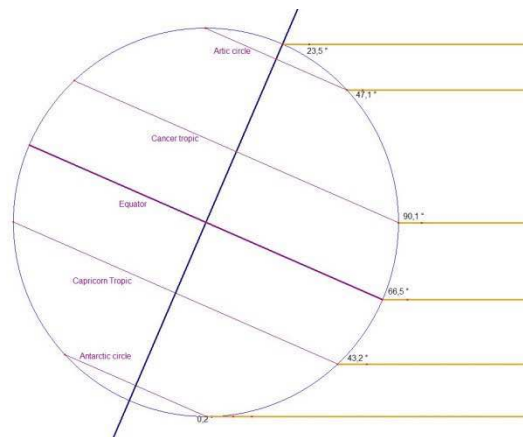

Figure 5. Cabri representation showing the angles formed by the sunrays at summer's solstice w.r.t. the tangent plane in specific Earth regions.

Then, drawing from the experimental activities results, students calculate the difference:

$$1 - \frac{P(\theta_w)}{P(\theta_s)} = 1 - \frac{\cos(\theta_w)}{\cos(\theta_s)} \quad (3)$$

for the five given locations of the Earth at the four times of the year. The angles θ_w and θ_s correspond to the winter and summer solstices for tropics and Equator, and to the summer/winter solstices and autumn/spring equinoxes for Arctic and Antarctic Circle, respectively. Finally, students calculate the difference:

$$1 - \frac{P(D_{Aphelion})}{P(D_{Perihelion})} = 1 - \left(\frac{D_{Perihelion}}{D_{Aphelion}} \right)^2 \quad (4)$$

and compare the result with that obtained for the five locations of the Earth from equation (3). In this way, the teacher can easily show that the difference in the radiation flow due to the change of the distance, independently on the location on the Earth's surface, could be at maximum 6.5%, which is much less than the differences obtained from (3). In such a way, the distance misconception can be quantitatively addressed.

At the end of the session, the teacher recalls what the students had predicted in the first activity about the absence of one of the identified factors (tilt of the axis, Earth-Sun distance) and compare their predictions with those of the discussed models. Hence, they are guided to understand that at a certain location, *without* any axis inclination, there would be only one season and the duration of night/day cycle would be the same all over the Earth's surface and along the whole year. Similarly, the teacher may underline also that, in the case of a perfectly circular orbit, the only effect would be an equal duration of the seasons due to the constant angular velocity of the planet (actually, the small eccentricity results in a difference of few days in the relative duration of the seasons).

3.4 Specific heat activity (2-4 hours)

In the fourth, and final, activity the students are guided to elicit their ideas about why Earth's locations at only slightly different latitudes have different average temperatures during the year. A typical Earth climate map is given to the students. The aim is to discuss the influence of the length of the day and to elicit the role of water and soil on the environment temperature. Students can then understand that, in principle, both the duration of exposition to the incident radiation and energy transfers with the environment affect the temperature of a given location on Earth. However, the activity is aimed at showing that energy transfers mainly depend on the environment. A simple model of thermal interaction is proposed, focusing in particular on the role of specific heat of involved substances. Students are asked to design another experiment in which they can evaluate the effect of such property. A typical experiment that students can easily perform involves the thermal interaction between water and a substance with unknown specific heat. For this activity we chose

sea sand to recall students' experience with the fact that during summer the sea takes much longer than the sand to become hot.

After heating at temperature T_{water} a mass m_{water} of water (specific heat $c_{\text{water}} = 1 \text{ cal g}^{-1} \text{ } ^\circ\text{C}^{-1}$), the students measure the equilibrium temperature T_e when the water mass is mixed with a mass of sand m_{sand} (of unknown specific heat c_{sand}), initially at temperature $T_{\text{sand}} < T_{\text{water}}$. Hence, using the equilibrium relationship: $\frac{c_{\text{sand}}}{c_{\text{water}}} = \frac{m_{\text{water}}(T_{\text{water}} - T_e)}{m_{\text{sand}}(T_e - T_{\text{sand}})}$, they can estimate the ratio $\frac{c_{\text{sand}}}{c_{\text{water}}}$ which should be around 0.3 - 0.4². In such a way,

students may justify how the presence of water contributes to the radiation transfer to the environment.

4. Evaluation of the module

The module was implemented with 45 secondary school students (17-18 years old) in South Italy, for a duration of 16 hours. The students had already studied some astronomical concepts in their Earth Science school curriculum, including seasons. However, given the differences in the programs of Physics and Sciences subjects (taught by different teachers), astronomical concepts are usually addressed only at a qualitative level without any reference to the underlying physics. Therefore, we chose such sample since we wanted to investigate whether the module's activities could improve students' conceptual understanding of seasonal changes from the physics viewpoint.

A written questionnaire featuring 16 questions about the relevant concepts of the module was submitted to the sample before and after the activities. The questions were organized into four items, each related to a factor underlying the cause of seasons, namely: the motion of the Earth around the Sun (*item 1, Q1-Q4*); the influence of the environment on the temperature at a given location (*item 2, Q5-Q8*); the inclination of the Earth's axis (*item 3, Q9-12*); Earth's axis constant direction in space (*item 4, Q13-Q16*). Each item had a two-tier structure: the first tier featured three true/false statements, the second tier one multiple choice question. The true/false statements concerned basic facts that the student should know to answer the multiple choice question. The multiple choice question featured a correct statement and three incorrect statements based on previous research studies on students' ideas about cause of seasons (Trumper, 2000). For each correct answer to the true/false statement a score of 0.5 was given, while, for a correct answer to the multiple choice question, 1 point was given, so that the total possible score was 10.

Thirty-four students completed both pre- and post-test. Overall, the average score in the pre-test was 5.6 ± 1.5 (st.dev.), while in the post test it was 9.2 ± 0.9 (st.dev.). The average normalized gain (Hake, 1998) was 79.3%, which suggests a large effect of module activities on students' conceptions. Differences in the average score between pre- and post-test are statistically significant (as measured by a t-test: $t = -11.956$, $df = 33$; $p < 10^{-4}$). The distribution of students' correct answers to the four items³ in the pre- and post-test is shown in Figure 6.

In the pre-test, students found difficulties especially in recognizing the role of the constant direction in space of the Earth's axis on the change of seasons (6% of correct answers) and in explaining the role of the environment on the temperature at a given location on the Earth (about 12% of correct answers). The tilt of the axis and revolutionary motion around the Sun seem the two factors the students used the most for explaining the cause of seasons (about 20% of correct answers in the corresponding items). However, despite the students in the sample had already addressed the topic in their Earth Science school curriculum, the varying distance between the Sun and the Earth and the changing direction of the Earth's axis emerged in about 40% of the answers as possible factors for the change of seasons. Surprisingly, the idea that the axis of Earth changes direction in space during the orbital motion emerged in about 20% of the answers.

In the post-test, the students improved their performance in all items, especially in the fourth one (about 80% of correct answers). Such evidence suggests that activities' focus on the relationships between the constant direction in space of the Earth's axis and the changing inclination of radiation flow on Earth's surface helped the students abandon naïve reasoning. Moreover, the emphasis on the thermal transfers in the fourth activity seems to have increased students' understanding of the basic factors that affect the climate of a region.

² A table of common substances specific heat can found at http://www.engineeringtoolbox.com/specific-heat-capacity-d_391.html. A typical average value of the specific heat of sand relative to water is 0.37 ± 0.06

³ An answer to an item has been considered correct if the score was maximum for the three true/false questions (1.5 points) and the multiple choice question (1 point)

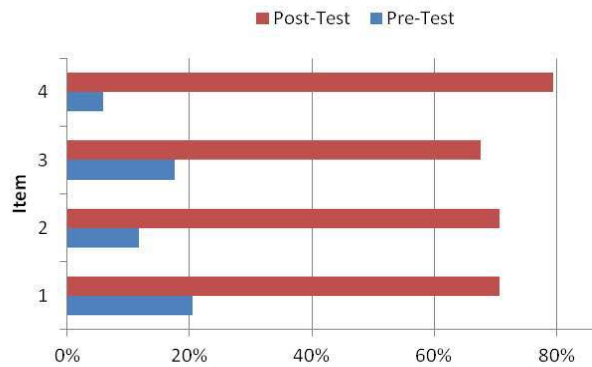

Figure 6. Distribution of students' correct answers for the four items in the pre- and post-test questionnaire. Each item featured 3 true/false questions and 1 multiple choice question.

5. Conclusions

In this paper, we have presented an inquiry-based module where students are gradually introduced to the basic physics concepts underlying the change of seasons. The module features both experimental and modelling activities to let students construct an interpretation mechanism for their every day experience with the seasons phenomenon. In particular, the physical quantities influencing the change of the seasons – namely, radiation flow (power per surface unit) and energy transfers between radiation and environment – are quantitatively measured by the students in simplified situations and then used to construct the models that account for the well known evidences related to the seasons. The radiation flow is introduced to justify the existence of different seasons, since it changes over the Earth's surface through the year. The cosine and inverse square laws are used to show that the effect on the radiation flow due to the tilt of the axis is greater than that of the change of the Earth – Sun distance. Students are engaged in discussions about what could happen if the axis of the Earth was not inclined but perpendicular to the orbit and if the distance between Earth and Sun would be constant. In the same way, specific heat of the sand with respect to water is used to interpret basic aspects of the energy transfers between the radiation and the substances (soil, water, rocks) that are present in the Earth's environment. The results of the pre- and post-test questionnaires are encouraging and support the effectiveness of the proposed activities. In particular, the distance misconception and the naïve idea that the Earth axis may change direction in space seem to have been successfully addressed. We plan to improve the module by designing an activity with Cabri Géomètre about the visualization of the incident radiation flow during the motion of the Earth and by completing the teachers' notes.

References

- Atwood, R. K. and Atwood, V. A. (1996) Preservice elementary teachers' conceptions of the causes of seasons *J. Res. Sci. Teach.* **33**, 553–563
- Bailey, J. M. and Slater, T. F. (2004) A review of astronomy education research *Astron. Educ. Rev.* **2**, 20–45
- Baxter, J. (1989) Children's understanding of familiar astronomical events *Int. J. Sci. Educ.* **11**, 502–13
- Blanchard, M. R., Southerland, S. A., Osborne, J. W., Sampson, V. D., Annetta, L. A. and Granger, E. M. (2010), Is inquiry possible in light of accountability?: A quantitative comparison of the relative effectiveness of guided inquiry and verification laboratory instruction. *Science Education*, **94**, 577–616.
- Galili, I. and Lavrik, V. (1998) Flux concept in learning about light. A critique of the present situation *Sci. Educ.*, **82**, 591–614
- Hake, R. R. (1998) Interactive-engagement versus traditional methods: A six-thousand-student survey of mechanics test data for introductory physics courses *Am. J. of Phys.* **66**, 64-74
- Küçüközer, H. (2008) The effects of 3D computer modelling on conceptual change about seasons and phases of the Moon, *Phys. Ed.* **43**, 632-636
- Lelliott, A. and Rollnick, M. (2010) Big ideas: A review of Astronomy education research 1974-2008. *Int. J. Sci. Educ.* **32**, 1771-1799

Metz, K.E. (2000) Young children's inquiry in biology: building the knowledge-bases to empower independent inquiry. In J. Minstrell & E. van Zee (eds), *Inquiring into Inquiry Learning and Teaching in Science*. American Association for the Advancement of Science: Washington DC, 371-404.

Mistler-Jackson, M., & Songer, N. B. (2000). Student motivation and Internet technology: Are students empowered to learn science? *Journal of Research in Science Teaching*, **37**, 459 – 479.

NCR [National Research Council] (1996). *National Science Education Standards: Observe, interact, change, learn*. Washington, DC: National Academy Press.

Sharp, J. G. (1996) Children's Astronomical beliefs: a preliminary study of year 6 children in southwest England *Int. J. Sci. Educ.* **18**, 685–712

Sneider, C., Bar, V. and Kavanagh, C. (2011) Learning about Seasons: A Guide for Teachers and Curriculum Developers. *Astronomy Educ. Rev.* **10** 010103-1–010103-22

Starakis, I. & Halkia, K. (2014) Addressing k-5 students' and pre-service elementary teachers' conceptions of seasonal change *Phys. Ed.* **49**, 231-39

Trumper, R. (2000) University Students' Conceptions of Basic Astronomy Concepts *Phys. Educ.* **35**, 9-15.

Affiliation and address information

Italo Testa

Department of Physics

University "Federico II" Napoli

Complesso M.S. Angelo,

Via Cintia 80126, Napoli, NA,

Italy

e-mail: italo@na.infn.it

Impact of a Discussion Method on High School Students' Understanding of Kinematics Concepts

Louis Trudel¹, Abdeljalil Métioui²

¹ *Université d'Ottawa,*

² *Université du Québec à Montréal,*

Abstract

Despite of its importance for future physics learning, Kinematics is a field where students' misunderstanding is the most pronounced. Our research aims to test the use of the discussion method allows students on the high school students' understanding of kinematical concepts. Our study consisted of four classrooms of a total of 122 French-speaking students of a 12th grade physics course given in three different high schools in Canada. To determine if the discussion had an effect on the understanding of the pupils, a repeated measures analysis of the variance was performed to determine if the increase of understanding according to the number of periods of the discussion method is linear. A positive and significant linear trend in students' understanding was present in two groups out of four where the discussion method had been implemented. In the two groups where there were no significant results, it appears from notes in the researcher's diary that the discussion method had not been implemented as planned. Our research therefore concludes with recommendations for future research to go further.

Keywords:

Discussion method, conceptual understanding, kinematics concepts

1. Introduction

If there is a domain which causes a lot of difficulties to the pupils, it is kinematics, defined as the study of the motion of objects without being concerned about its causes (Arons, 1997). There are two main reasons put forward by the researchers: alternative schemas which the pupils already have on the properties of motion and the emphasis put on the mathematization of its properties in the teaching of kinematics. Firstly, the pupils have, before arriving in the physics course, a broad experience about the properties of motion which they have acquired in their interactions with daily events. These experiences allowed them to construct schemas with which they can interpret the phenomena of motion (Knight, 2004). Particularly, these schemas resemble those developed by historical figures such as Aristote (Espinoza, 2005). These schemas are completely adapted to the common life tasks: drive a bike, catch an object, etc. However, these schemas may differ from scientific concepts. In certain cases, these schemas may even interfere with learning, especially if the teacher does not take them into account. In that case, there is great danger that the pupils differentiate school knowledge, which works in the school (for instance, in the laboratory), of daily knowledge, who allows them to react with effectiveness to events of the common life (Arons, 1997). Secondly, during laboratory activities, kinematics is often approached with the aid of a mathematization to which the pupils are not accustomed. For instance, a common pedagogic technique consists in bringing the pupils, at the beginning of the study of kinematics, to the laboratory where they measure different properties of motion which they then put in graphs. Back in class, they analyze their results and perform calculations with the aid of mathematical expressions to get the values of the speed and acceleration. And yet, it appears that the pupils perform these various operations without a real understanding of what they are doing (De Vecchi, 2006).

These different sources of difficulty have led researchers to make improvements to daily teaching practices. First, the study of everyday phenomena has been suggested because they are likely to let emerge students' thinking patterns (Knight, 2004). Hence, study of everyday phenomena occurs mainly either in teacher demonstrations of physics phenomena or in laboratories where students are grouped into small teams. In particular, labs are mainly used to check the content covered in the course. Indeed, the traditional approach in laboratory is very structured. The objectives of the experience and methods are selected in advance by the teacher. The main students' activities consist of executing procedures, collecting and analyzing data. Students' participation is passive and at low cognitive level (De Vecchi, 2006; Hofstein & Lunetta, 2004). So it is not surprising in this context that some researchers found that there is little difference in terms of

potential cognitive gains between demonstration by the teacher and practical activities by students (Roth, McRobbie, Lucas & Boutonné, 1997). As such, it seems that the distinction between the demonstration and the laboratory is essentially based on whom of the teacher or students, controls the activities. Indeed, in the laboratory, students exert more control over the selection, organization and pace of learning while in the demonstration, it is the teacher who controls the flow of activities. However, it may be that the aspect of "Who controls the manifestation of the phenomenon?" is less important, with respect to understanding, that the opportunities for students, when using a given method, to build a coherent representation of the phenomenon (Roth, McRobbie, Lucas & Boutonné, 1997).

In addition, various factors have been invoked to explain the lack of conclusive results of either the demonstration or the laboratory. Taking into account the influence of these factors has led researchers to propose more complex teaching strategies to promote student understanding while research uncovers their multiple influences on understanding (Brown & Hammer, 2013). From what precedes, one must infer that the mere presentation of phenomena in demonstration or experimentation in laboratory experimentation does not seem sufficient to enable students to change their way of understanding (Roth & al., 1997). Indeed, it may be that the phenomena presented by the teacher during the demonstration or reproduced by the student in the laboratory do not call into question students' conceptions. It is for this reason that many researchers have proposed to choose the phenomena that destabilize students contradicting their initial conceptions (Vosniadou, 2013). The objective of this procedure is to induce conceptual conflict when the student realizes that his conceptions are insufficient to explain or predict phenomena. In this method, the teacher guide and support students in their efforts to change their conceptions so that they appear fruitful, intelligible and plausible. Nevertheless, research has shown that the introduction of phenomena specifically chosen to undermine students' ideas is rather ineffective to change them. One reason for this failure lies partly in how students react to data that seem to contradict the ideas they maintain about the physical phenomena (Niaz, 2008). In fact, students can adopt different behaviors in order to safeguard the "hard core" of their conception, that is to say, the ideas that constitute their most fundamental beliefs (Chinn & Brewer, 1993). To help students become aware of the gap between ideas and the phenomena, authors recommend that students discuss with each other about the phenomena studied and verify their ideas with experiences. Indeed, a discussion with peers provides students with various feedbacks about their ideas, confront them to other ways of interpreting the phenomena and prevents premature closing by boosting awareness of their deficiencies in understanding. The student and would come to gradually adopt a more coherent and adequate representation of phenomena (Inagaki and Hatano, 2013).

However, if most authors agree that discussion encourages the expression of students' ideas about the phenomena and the evaluation of their merits, it is not certain that the discussion leads to a more thorough understanding of scientific concepts. Hence, the link between the discussion and understanding of concepts has not been established through research in a clear way. Indeed, various proposed strategies such as discussion often consist of several educational interventions, the discussion is only one element, so that the effect of the discussion of comprehension is difficult to assess. In addition, the discussion as a teaching method is poorly defined and often associated with exchanges between students (Dillon, 1995). Therefore, in this research we aim to achieve the following objectives. The first and second objectives are concerned with the conception (1) and identification of the conditions of implementation (2) of a discussion method about the properties of kinematical phenomena which takes into account students' alternative schemas. The third objective (3) is concerned with assessing the effect of such a strategy on high school students' understanding of kinematical concepts.

2. Conception of the discussion method

From what precedes, it appears that to promote understanding of motion, discussion should focus everyday phenomena of motion, for at least three reasons. First, complex phenomena require the student to iteratively engage in a process of understanding where it is more likely to gradually occupy increasingly complex levels of understanding (Miyake, 2013). Second, the use of daily phenomena helps develop cognitive schemas that the student has motion, which facilitates their review and modification. Moreover, since the demonstration and the laboratory give equivalent results, we chose to use, for practical reasons, the demonstration rather than the laboratory to introduce students to the phenomena. In addition, using the demonstration, the teacher can further guide student's approach to understanding. To avoid looking for a single solution and to facilitate students' expression of their ideas, the discussion should focus on problems or physical situations involving qualitative reasoning. Finally, to avoid premature closure of the debate on an erroneous explanation, discussion should focus on cases that challenge students' ideas. In addition, to

encourage students to generalize their results, the discussion should focus on a set of cases covering all aspects of kinematics.

To establish and maintain the discussion, the teacher should focus on discussion animation and management and refrain to give his opinion about the phenomena studied. To this end, the teacher gives instructions to follow during the discussion, sets or revises the rules of operation, describes the objectives, establish limits and constraints, and creates an organization promoting interactions between students. To keep the discussion in line with its objectives, the teacher must summarize and clarify students' remarks, assess whether students have talked enough and are ready to switch to another theme, focus on a specific point or extend the field of investigation, redirect the group's efforts towards the objectives of the discussion. The teacher creates a safe environment where all students can express their ideas in a climate of trust and acceptance. The teacher invites silent members to express themselves and avoids discussion time is monopolized by some members. To promote the participation of the largest number of students and facilitate interactions between them, they should be divided into small groups of four to five students. The seats are arranged in circle, forming small islands, so that all participants can see and hear each other, and facilitating exchanges. These islands are distributed in a circle around the experimental set up so that all teams can distinctly see the teacher's demonstrations. However, to ensure that students receive the whole class feedback, we also expected that the results of the deliberations of teach team are regularly discussed with the whole class group under the supervision of the teacher. This class discussion allows the teacher to synthesize the results of the exchanges between students in teams. Choosing a team spokesman allows the group to express the consensus reached within the group. In the class discussion, the teacher makes sure to tour the teams and to get students to comment on the ideas of the other teams. In addition, he challenges students by asking them to test their ideas by suggesting changes to the set up.

In this regard, it is important that the activities offered to students in small groups are structured to channel their interactions towards the achievement of learning objectives. In addition, a better framework for discussions between students empowered them and therefore facilitates teacher's management of activities. To this end, an activity guide is distributed to each student, containing the objectives of the method of discussion, the way forward, the description of montages, the structure of activities, questions to answer, expected results, etc. In addition, the specification guidelines are likely to overcome students' lack of communication skills. The guide contains concrete physical situations highlighting various properties of the movement. In each situation, activities (questions to answer, graphics profile, etc.) are proposed to facilitate students' modeling of the properties of movement. We call "case" such a design. In addition, the tasks proposed to the student should allow him to use his cognitive patterns to accomplish the scientific functions of predicting, describing and explaining scientific phenomena. To this end, the POE tasks allow students to develop their scientific understanding in a structured way. POE task is composed of three parts: 1) a physical situation is shown to the students and the teacher describes the experience he wants to achieve with this arrangement; 2) the teacher asks students to: a) predict the outcome of the experiment described; b) to write a justification of their prediction; 3) the experience is then made to students and the teacher asks them to describe their observations and explain the difference, if any, between predictions and observations (Dekkers, 1997). For example, one of the phenomena studied concerns the uniform motion (see Figure 1). This phenomenon can be represented by the motion of a ball rolling on a straight horizontal track. Regarding uniform straight motion, the first case subjected to the pupils is represented in the guide in the following way: « A ball is thrown on a horizontal rail. The circle in grey points out its initial position at the time of launching. The circle with symbol 1 inside points out the position of the ball after 1 second (see fig. 1) ».

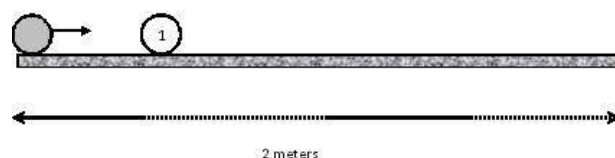

Figure 1. Motion of a ball traveling a horizontal rail

During the observation phase, the teacher stands in front of the set up and describes the experience he intends to do. Once students have registered their predictions in their notebook, the teacher asks students to observe the product phenomenon. He can repeat the demonstration several times to ensure that students have had the opportunity to observe the various characteristics of the phenomenon. Subsequently, the teacher asks students to

discuss in teams. During this discussion, students answer questions from the guide. They compare their predictions with each other and try to explain any difference between their predictions and observations. Thereafter, when the teacher finds that students have sufficiently discussed in teams, he began a discussion with the whole class, where each team, through his spokesman, explains and defends its position. The role of the teacher at this time is to encourage the participation of the largest possible number of students, to clarify and summarize what have been exchanged and classify the ideas into categories and to get students to offer tests to verify their ideas. When he believes the students have sufficiently understood the phenomenon, the teacher chooses the next case in the guide and until all situations of motion have been studied.

3. Methodology

To assess the attainment of our three research objectives, we used a mixed methodology combining qualitative and quantitative methods (Creswell, 2009). The first two research objectives concerning conception and study of the conditions of implementation of the discussion method is treated by qualitative methods, namely the diary, and semi-guided interviews with teachers engaged in the study. The third research objective concerning the evaluation of the effects of the learning sequence on students' understanding of kinematics concepts will be treated by quantitative methods in a quasi-experimental research design (Shadish, Cook & Campbell, 2002). Our study consisted of four classrooms of a total of 122 French-speaking students of a 12th grade physics course given in three different high schools in Canada. The first two groups come from the same school. This is a private secondary school located outside the metropolitan area of Montreal. It differs from the public sector in that the schedule is based on a five-day cycle rather than a nine-day cycle so that students taking the introductory course physics at the same time from one cycle to another. Students in the third and fourth groups are studying in public school in a secondary school in the suburbs of Montreal. These are public high schools whose schedule are based on a nine-day cycle, that is to say, the different courses are spread over a period of nine days. The first teacher teaches introductory physics to the first two classes of students. The second and third teachers teaches physics to the third and fourth classes respectively. The main researcher replaced the third teacher to implement the discussion method in the fourth group. All teachers engaged in the study (including main researcher) have between 17 and 20 years of schooling, including training in pedagogy. Their experience in teaching range from 6 to 19 years.

The approach described in the previous paragraph took place in an introductory physics course in high school during four successive periods of one hour and quarter for the first three groups and three periods of same duration for the fourth group. In each of these periods, the pupils had to answer a question taken haphazardly in a bank of problem during the first five minutes of the period (Lin & Lawrenz, 1999). Moreover, there were supplementary measures of understanding immediately before and after the implementation of the approach according to a ABA design. During experimentation, the main researcher was present at each of the periods to observe the sequence of activities and take the measures of understanding. He also played the role of monitor of laboratory. He was involved in the training of the teachers with respect to the discussion method and also conducted the semi-guided interviews with them. To study the implementation of the discussion method in the four classrooms chosen, the main researcher held a research diary where he recorded his observations on the sequence of events, the critical details regarding the introduction of the discussion method by the teacher, comments of the teacher in meetings with the main researcher, and links that the main researcher could establish between his observations and the theoretical framework of the present research diary (Altrichter & Holly, 2005). During the experimentation, the main researcher or one of his research assistants were present at each of the periods to observe the unfolding of the events and take the measures of pupils' understanding. The main researcher or one of his assistants also played the role of monitor of laboratory, to solve the difficulties which may arise with the experimental set up or the use of data and analysis software by the pupils. The main researcher conducted also semi-guided interviews with the teachers engaged in the study. To measure the evolution of understanding according to the number of periods dedicated to the use of the discussion method, we conceived a test of kinematics motion after a literature review on the subject (Trudel, Parent & Auger, 2008).

To prove our research hypothesis, it is necessary for us to determine if every opportunity of measure is superior to the previous measure so that the increase of understanding according to the number of periods of discussion method introduces a linear tendency. An analysis of the variance of repeated measurements performed with the aid of orthogonal polynomials allow to test separately linear, quadratic, cubic, etc, tendencies (Howell, 2008). To measure the evolution of understanding according to the number of periods dedicated to the use of the discussion method, we conceived a test of understanding of the constant speed

(Trudel, Parent & Auger, 2008) [19]. Since every pupil is measured at several occasions, conditions in which these measurements are taken may vary, that it is in the day of the week, the hour during day, etc. So, a pupil may not get the same result in answering questions of identical difficulty because he is tired or irritated during a particular occasion. In such a case, where the temporal dimension is important, the choice of an item response model must take into account the variations in the course of the time of the answers of the pupils. As such, the model with facets developed by Linacre (Bond & Fox, 2007) allows considering the influence of these different factors or 'facets' on the measure of understanding. The calculation of the different parameters linked to these factors (or facets) is made by the model equation which links up the values of parameters with observations:

$$\text{Log} [(P_{nij}) / (P_{nij-k-1})] = (B_n + T_i) - (D_j + F_k) \quad (1)$$

where:

P_{nij} is likelihood that the pupil 'n' sees itself granted a level 'k' at occasion 'i' when he answers question 'j'.

$P_{nij-k-1}$ is likelihood that the pupil 'n' sees itself granted a level 'k-1' at occasion 'i' when he answers question 'j'.

B_n is the skill of the pupil 'n'.

T_i is the more or less easiness with which the pupils answer at occasion 'i'.

F_k is the difficulty linked to the jump of level k-1 at level k.

The various properties of the Facets model make it an appropriate tool for our analysis. Firstly, the various parameters calculated by the model from observations have the properties of an interval scale. Secondly, the model allows the calculation of values for all pupils during all occasions of measure, including missing data, which increases the power of the statistical tests used. In order to do so, the model calculates for every pupil a value of the logarithm of its likelihood to produce a correct answer to the question subjected to each of the periods of the experimentation. To determine if the discussion method had an effect on the understanding of the pupils, a repeated measures analysis of the variance was performed of the computed values. This analysis allows us to compare the results of the pupils between the different occasions of measure and to determine if one of these results differs significantly from the others. This comparison can take a specific form called contrast. To prove our research hypothesis, it is necessary to determine if the increase of understanding according to the number of periods of the implementation of the discussion method is linear. As such, it is possible, with the aid of orthogonal polynomials to separate the contributions from the linear tendencies and higher polynomials (quadratic, cubic, etc). Besides, these elements of variance being independent to each other, they can be separately tested (Howell, 2008).

4. Presentation, analysis and interpretations of results

In this research, we aim to verify the following hypothesis: "The discussion method as described previously has a positive impact on high school students' understanding of kinematic concepts". Moreover, since we are interested in checking out our hypothesis in various settings to increase external validity, we have chosen four different school environments, urban and suburban, private and public. Therefore, we will also describe the characteristics of each classroom context that may throw some light to explain the results obtained for each group from 1 to 4. With respect to first group, Table 1 shows the results of the omnibus test for the three phases: before using the method of discussion (BEFORE), while using the method of discussion (DISCUSSION) and after the use of the method of discussion (AFTER). We report in Table 1, the value of the F ratio, the degrees of freedom of the numerator (source of variation) and denominator (error term) of the F ratio and the degree of significance of each phase of the experimentation.

Table 1. Test omnibus of each phase of first group

Source of variation	F	Degrees of freedom (source of variation ; error)	Degree of significance
BEFORE	3,213	5 ; 175	0,008**
DISCUSSION	1,971	3 ; 105	0,123
AFTER	1,097	3 ; 105	0,354

Note : ** : significant to alpha level of 0,01

The study of Table 1 shows that the null hypothesis of "no difference in understanding between different opportunities of measurement" is rejected at the "BEFORE" phase only. Therefore, in the prior phase, the average value of comprehension is significantly different. Since the omnibus test rejects the null hypothesis of no difference between means in the phase BEFORE we check the linear trend in understanding in this phase only. The result of this analysis is shown in Table 2. We report in Table 2, the value of the F ratio, the degrees of freedom of the numerator (source of variation) and denominator (error term) F report and the degree of significance of each phase of the experiment.

Table 2. Analysis of the linear tendency of results in first phase of the first group

Source of variation	F	Degrees of freedom (source of variation ; term of error)	Degree of significance
BEFORE	0,017	1 ; 35	0,897

From Table 2, the results of phase "before" did not identify significant linear trend in understanding based on the number of measurement occasions. Moreover, since the result of the omnibus test does not allow us to reject the null hypothesis of "no difference in understanding between different measurement occasions" during the discussion, we conclude that the discussion did not have a significant effect on understanding in the first group. In the first group, we found the absence of a significant linear trend in all phases of the experiment. This absence can be explained in different ways. First, various field observations lead us to believe that the discussion method had not been implemented as planned in this group: 1) low participation of students, especially girls, in the discussion; 2) pattern of interactions between students and teachers more like a recitation; 3) Quick covering of cases by the teacher that does not facilitate discussion among students. From our observations, this low participation can also be explained by a negative class climate which makes it difficult for students to express their ideas. It is also possible that students did not understand the role they should play in the discussion so they did not follow the rules thereof (Costa, 1990).

As regards the second group, a linear trend, positive and significant, was highlighted during the implementation of the method and also after removal of the discussion (see table 3). As with the first group, we need to check for a given phase, if there is an average score of understanding of the second group at a given opportunity that is significantly different understanding of the values obtained on other occasions. Omnibus test values for the three phases are shown in Table 3. In examining Table 3, we find that only the phases of "DISCUSSION" and "AFTER" discussion allow us to reject the null hypothesis of no difference between the average values of the understanding in the different occasions of measurement.

Table 3. Test omnibus of each phase of the second group

Source of variation	F	Degree of freedom (source of variation ; term of error)	Degree of significance
BEFORE	0,328	5 ; 130	0,896
DISCUSSION	11,505	3 ; 78	0,000**
AFTER	10,177	3 ; 78	0,000**

Note : ** : significatif au seuil de 0,01

From Table 4, we find that the initial phase does not produce a significant linear increase understanding. For cons, the phase associated with the discussion demonstrates that understanding is linearly related to the number of discussion periods and that this trend is significant at the alpha level of 0.05. Similarly, in the AFTER phase, the linear trend in understanding is significantly related to the number of periods of this phase.

Table 4 . Analysis of linear tendency of results of each of phase of the second group

Source of variation	F	Degrees of freedom (source of variation ; term of error)	Degree of significance
DISCUSSION	12,38	1 ; 26	0,002**
AFTER	9,556	1 ; 26	0,005**

Note : * : significant at the alpha level of 0,01

These results for the second group may be explained in several ways. First, it is possible that the method of discussion has a positive impact on students' understanding, given the fact that it was implemented largely as planned according to our classroom observations. In support of this view, we observe that the teacher involved is concerned about student learning and, in his practice, he does not hesitate to use active teaching methods to engage students, even "take risks" as he himself admits in an interview. For example, he does not hesitate to challenge his students by asking them problems they have to find the solution by experiments. As such, he was the most involved teacher in the practice of the discussion method before the research began. However, the absence of a decline in this understanding, following the withdrawal of the method of discussion, does not allow us to exclude the possibility that this increased understanding is rather associated with the presence of a fluctuation in student achievement in the comprehension test.

As regards the third group, no significant linear trend could be demonstrated either before or during the implementation of the discussion method. Moreover, after the withdrawal of the discussion method, we could not get enough measures of understanding to determine a linear trend. As with the first two groups, we need to check for a given phase, if there is an average of the understanding of the group at a given opportunity that is significantly different from the average values of understanding obtained on other occasions. The omnibus test values for the first two phases of the third group are shown in Table 5. By studying Table 5, we find that only Phase "BEFORE" allows us to reject the null hypothesis of no difference between the values of mean understanding at various occasions measure.

Table 5. Test omnibus of the first two phases of third group

Source of variation	F	Degrees of freedom (source of variation ; term of error)	Degree of significance
BEFORE	7,471	7 ; 203	0,000**
DISCUSSION	1,041	3 ; 87	0,379

Note : ** : significant at the alpha level of 0,01

Therefore, we will check whether the data of phase "BEFORE" have a linear trend. From Table 6, we find that the initial phase does not produce a significant linear increase in understanding. In summary, the analyzes that we conducted, we can not reject the null hypothesis of no linear trend in the relationship between the number of periods for discussion and understanding in the case of the third group.

Table 6 . Analysis of linear trend of the results of the first phase of third group

Source of variation	F	Degrees of freedom (source of variation ; term of error)	Degree of significance
BEFORE	0,738	1 ; 29	0,397

Note : * : significatif au seuil de 0,01

With respect to those results of the third group, the analysis of our field observations and analysis of transcript of interview lead us to conclude that certain requirements of the discussion method were not followed: 1) the teacher was not well prepared to manage the discussion; 2) the pattern of interactions between students and the teacher was more like a recitation rather than a discussion; 3) few students expressed opinions on the phenomena presented and comments from students were rarely on ideas expressed by other students. Regarding the lack of teacher preparation, it is possible that not having time to be familiar with the experimental set-up, he did not know how to operate it effectively, so that opportunities for students to gather information on the motion phenomena or to verify their ideas were restricted (Hatano & Inagaki, 1991; Viennot, 2003). In addition, the teacher often sought to impose the correct solution rather than giving students the opportunity to debate.

With regard to the fourth group, we note that in the phase preceding the implementation of the discussion method, there were no significant linear trend. In the opposite way, we note the presence of a linear, positive and significant trend in understanding during the implementation of the discussion method while following its withdrawal, students' understanding decline significantly. Table 7 verifies, for each phase, the null

hypothesis of no difference between the values of the average student understanding at different measurement occasions.

Table 7. Test omnibus of each phase of the fourth group

Source of variation	F	Degrees of freedom (source of variation ; term of error)	Degree of significance
BEFORE	10,65	4 ; 112	0,000**
DISCUSSION	9,822	2 ; 56	0,000**
AFTER	5,224	6 ; 168	0,000**

Note : ** : significant to alpha level of 0,01

The study of Table 7 shows that the null hypothesis of "no difference in understanding between different occasions measure" is rejected in three phases. Therefore, the linear trend will be tested in all three phases. The results of these analyzes are shown in Table 8. From Table 8, we find that the initial phase does not produce a significant linear increase in understanding. For cons, the phase associated with the discussion demonstrates that understanding is linearly related to the number of discussion periods and that this trend is significant at the alpha level of 0.01. Similarly, in the AFTER phase, understanding is linearly related to the number of periods of this phase and this trend is significant at the alpha level of 0.05.

Table 8. Analysis of linear tendency of the results of each phase of the fourth group

Source of variation	F	Degrees of freedom (source of variation ; term of error)	Degree of significance
BEFORE	0,03	1 ; 28	0,863
DISCUSSION	12,15	1 ; 28	0,002**
AFTER	10,78	1 ; 28	0,018*

Note :

* : significant to the alpha level of 0,05

** : significant to the alpha level of 0,01

This lack of linear trend before the introduction of the method of discussion is surprising in our view, given that students have covered, with their teacher, all the concepts of kinematics during this phase. Moreover, this teacher has extensive experience of teaching physics and uses various methods to facilitate student learning, such as lectures, problem solving sessions and labs. We may conclude from these results that the positive significant trend in understanding during the implementation of the method of discussion and the following decline may be caused by the implementation followed by the withdrawal of the discussion method. However, it is also possible that this increase is the result of an interaction between the method of discussion and teaching methods used by the teacher before the implementation of the method of discussion (Nelson, 1973).

5. Discussion and conclusion

By checking the impact of the method of discussion on understanding in four secondary five classes in schools in the Montreal area, we found a significant positive linear trend during the implementation stage of the discussion in the second and fourth groups. According to our observations, the discussion method was implemented in part as planned in the second group and fully as expected in the fourth group. Therefore, it is possible that the method of discussion has produced a significant impact on student understanding. Nevertheless, changes to our research design in the second and fourth groups have not ruled out the possibility that other factors may be responsible for the gradual rise of understanding in both groups during the implementation of the discussion. Thus, in the second group, it is possible that the positive linear trend (and significant) may be a reflection of a cycle or a fluctuation in the data. In the fourth group, it is possible that the positive linear trend (and significant) is the product of an interaction between previous learning and discussion method itself.

In both groups where no significant linear trend was highlighted, it is not possible to confirm or refute the research hypothesis. First, this negative result may be partly linked to the difficulty of establishing a class

discussion, especially in science. In addition, the method of discussion we have developed consists of a set of requirements that must be followed to ensure the effectiveness of this method to promote understanding of science students. If any of these requirements are not fulfilled, it may affect the fulfillment of other requirements, as we have shown in the first and third groups, so that no impact is observed on understanding. The complexity of the sources of influence, which may affect the effectiveness of teaching methods such as discussion promote understanding, has already been emphasized by various authors (Brown & Hammer, 2013). Secondly, we must also mention that the method of discussion, as conceived, perhaps did not produce any impact on the understanding of these two groups. For example, the method is perhaps not conducive to the establishment of exchanges between students, mainly because it is too much under the control of the teacher. It also may not permit in a sufficient way the verification by the students of their ideas, as only one set up is available for the entire class. In conclusion, the results of our analyzes suggest that the method of discussion, when applied as directed, allows students to further link the information provided in the problems of our kinematics test. This conclusion is subjected to the reservation that our description of the implementation of the discussion reflects the events that took place there.

Comparing our results with other studies, we note that some of their results confirm our findings, such as the method of discussion allows students to better link their knowledge together. By cons, this research also highlight other impacts of the method of discussion that have not been studied in ours. Particularly regarding reciprocal teaching, Brown and Campione (1990) mention the retention of knowledge, the ability to classify information into categories, development of strategies for the student to learn by himself. With respect to another discussion method named hypothesis-experiment-instruction method, it would allow, according Hatano and Inagaki (1991) the development of better explanation, conceptual change, greater success at mass conservation tasks. Finally, regarding the usefulness of a discussion after a laboratory, Nelson and Abraham (1976) suggest that the method of discussion allows students to produce more inferences, and of better quality, than informal lecture.

Regarding the implementation of the method of discussion in schools, it seems it raises difficulties, as mentioned by various authors (Gall and Gall, 1990; Dillon, 1994). As such, Brown and Campione research tells us about the difficulties encountered in the application of reciprocal teaching method, which proved effective in controlled conditions, but not in the school environment where the control of variables is more difficult. Thus, the example shows that some details of teaching methods such as discussion can have an important influence on subsequent student learning, details that Viennot (2003) calls "critical". For example, the replacement of the large board by smaller ones in the previous research resulted that students could not share their solving approaches, neutralizing the role of the latter as a place for exchanges between students. In light of these observations, it seems appropriate to take another look at what happened in our research with respect to the groups where no significant linear trend was found.

Thus, in the first group, the lack of impact on the understanding can be explained by the negative climate that prevailed there, but it is also possible that the modification of a detail of the discussion method by the teacher has changed other method parameters, thus neutralizing its effectiveness in promoting understanding. Indeed, we have already mentioned that the teacher, perceiving his students as gifted, covered quickly the various cases, leaving little time to students to discuss the phenomena presented. Therefore, it is possible that students, who have not had the time to develop a prediction or explanation of the phenomenon, did not dare to speak, so that the entire class did not benefit from exchanges that could have otherwise changed their ways of understanding. In the case of the third group, it may be that the teacher did not have time to become familiar with the set-ups and thus could not operate them effectively, for example by drawing the attention of the student on some conceptual difficulties or modifying assembly to provide more opportunities for students to test their own ideas. These two examples seem consistent to the notion of "critical details" exposed by Viennot (2003). According to the latter, teachers modify the methods they appropriate, which may explain the relative ineffectiveness of our discussion method in the first and third groups.

In conclusion, a distinctive result of our research concerns the fact that the method of discussion seems to have an impact on student understanding as long as it is implemented properly and provided that the description we have made of the implementation of this method in groups represents really what happened. Specifically, and without prejudice, the method of discussion seems to help students make connections between the information they collect about phenomena or between knowledge they already have on them, so they are progressively better able to answer questions at greater level of understanding. Furthermore, it appears that our study further clarifies the role of certain aspects associated with the implementation of the method of discussion on the effectiveness of the latter to promote understanding in science: difficulty for science teachers to appropriate the method of discussion, influence of some implementation details (eg, the

transformation of the method of discussion by the teacher) on the other components of the method of discussion, interaction between certain contextual characteristics and course of the discussion. Given these various sources of influence, our research is important in that it examines the effectiveness of the method of discussion where it is likely to be used, that is to say, the school environment.

Regarding the limitations of our research, the selection of teachers, and therefore of classes of students, was done on a voluntary basis. Therefore, the link, we have confirmed between the method of discussion and understanding, cannot be generalized to the entire population of secondary students who take an introductory course in physics in Canada. In addition, factors associated the context in which the research hypothesis was checked, could not be controlled. Using a diary and interviews of the analysis carried out with the teachers involved have allowed us to identify some potential factors and to assess the possible impact on our results. These factors are the degree of teacher preparation to use the method of discussion, class climate, and possibly fatigue of students. With respect to recommendations for future research, we first suggest that in order to increase the efficiency of the method of discussion, teacher training in the discussion should be given special attention (Costa, 1990). It may be also appropriate to train students in discussion by providing preparatory sessions where students learn to master the skills of discussion, such as the operating rules of discussion (Costa, 1990). With regard to improving the discussion method used in this research, each team could have its own experimental set-up so that students could be more in contact with the motion phenomena studied. Thus, they could follow a path of their own and they would, therefore, have more opportunities to modify the set-up to test their ideas. The teacher would summarise with the class after the teams study several cases. The discussion therefore would emerge enriched of all those contributions from the teams' various pathways. Finally, due to the limited number of classrooms involved, further research is required, extended to many classrooms in diverse contexts, to establish in a more objective way the effect of the discussion method proposed here upon students' understanding of kinematical concepts.

References

- Arons, A.B. (1997). *A guide to introductory physics teaching*, 2nd ed. Toronto: John Wiley & Sons, 1997.
- Bond, T.G. & Fox, C.M. (2007). *Applying the Rasch model : Fundamental measurement in the human sciences*, 2nd ed. Mahwah (New Jersey) : Lawrence Erlbaum Associates.
- Brown, A.L. & Campione, J.C. (1990). Interactive learning environments and the teaching of science and mathematics. In Gardner, M., Greeno, J.G., Reif, F., Schoenfeld, A.H., diSessa, A. & et Stage, E. (Eds.), *Toward a scientific practice of science education* (pp. 111-139). Hillsdale (New Jersey) : Lawrence Erlbaum Associates.
- Brown, D.E. & Hammer, D. (2013). Conceptual change in physics. In S. Vosniadou (Ed.), *International handbook on conceptual change*, 2nd ed. (pp. 121-137). New York: Routledge.
- Chinn, C. & Brewer, W.F. (1993). The role of anomalous data in knowledge acquisition : A theoretical framework and implications for science instruction. *Review of Educational Research*, 63(1), 1-49.
- Costa, A.L. (1990). Teacher behaviors that promote discussion. In Wilen, W.W. (Ed.), *Teaching and learning through discussion : The theory, research and practice of the discussion method* (pp. 45-77). Springfield (Illinois) : Charles C. Thomas.
- Creswell, J. W. (2009). *Research design: Qualitative, quantitative, and mixed methods approaches*. Los Angeles: Sage.
- De Vecchi, G. (2006). *Enseigner l'expérimental en classe: Pour une véritable éducation scientifique*. Paris : Hachette.
- Dekkers, P.J.J.M. (1997). *Making productive use of student conceptions in physics education : Developing the concept of force through practical work*. Doctoral thesis, Amsterdam, Université de Vrije.
- Dillon, J. T. (1995). Discussion. In L.W. Anderson (Ed.), *International Encyclopedia of teaching and Teacher Education*, 2^e éd., (pp. 251-255). Toronto : Pergamon Press.
- Dillon, J.T. (1994). *Using discussion in classrooms*. Philadelphia : Open University Press.
- Espinoza, F. (2005). An analysis of the historical development of ideas about motion and its implications for teaching, *Physics Education*, 40(2), 139-146.
- Gall, J. & Gall, M.D. (1990). Outcomes of the discussion method. In Wilen, W.W. (ed.), *Teaching and learning through discussion : The theory, research and practice of the discussion method*, (pp. 25-44). Springfield (Illinois) : Charles C Thomas, Publisher.

- H. Altrichter, H. & and M.L. Holly, M.L. (2005). Research Diaries. In B. Somekhet C. Lewin (Eds), *Research Methods in the Social Sciences*, chap. 2. Thousand Oaks (Californie) :SAGE.
- Hatano, G. & Inagaki, K. (1991).Sharing cognition through collective comprehension activity. In Resnick, L.B., Levine, J.M. &Teasley, S.D. (Eds.),*Perspectives on socially shared cognition* (pp. 331-348). Washington (DC) : American Psychological Association.
- Howell, D.C. (2008). *Méthodes statistiques en sciences humaines*. Bruxelles : De Boeck.
- Hofstein, A. &Lunetta, V.N. (2004). The laboratory in science education: Foundations for the twenty-first century. *Science Education*, 88(1), 28-54.
- Inagaki, K. and Hatano, G. (2013).Conceptual change in naïve biology.In S. Vosniadou (Ed.), *International handbook on conceptual change*, 2nd ed. (pp. 195-219). New York: Routledge.
- Knight, R.D. (2004). *Five Easy Lessons: Strategies for Successful Physics Teaching*. San Francisco: Addison Wesley, 2004.
- Lin, H.S. &Lawrenz, F. (1999).Using time-series in the assessment of teaching effectiveness.*Science Education*, 83, 409-422.
- Miyake, N. (2013). Conceptual change through collaboration.In S. Vosniadou (Ed.), *International handbook on conceptual change*, 2nd ed. (pp. 466-483). New York: Routledge.
- Nelson, M.A. (1973). Discussion strategies and learning science principles.*Journal of Research in Science Teaching*, 10(1), 25-38.
- Nelson, M.A., & Abraham, E.C. (1976).Discussion strategies and student cognitive skills.*Science Education*, 60(1), 13-27.
- Niaz, M. (2008).*Teaching general chemistry: A history and philosophy of science approach*. New York: Nova Science Publishers.
- Roth, W.-M., McRobbie, C.J., Lucas, K.B. & et Boutonné, S.(1997). Why may students fail to learn from demonstrations? A social practice perspective on learning in physics.*Journal of Research in Science Teaching*, 34(5), 509-533.
- Shadish, W.R. Cook, T.D., Campbell, D.T. (2002).*Experimental and quasi-experimental designs for generalized causal inference*.Boston: Houghton Mifflin.
- Trudel, L.,Parent, C. & Auger, R. (2008). Développement et validation d'un test mesurant la compréhension des concepts cinématiques en physique au secondaire. *Mesure et évaluation en éducation*, 31(1), 93-120.
- Viennot, L. (2003). Relating research in didactics and actual teaching practice : Impact and virtues of critical details. In Psillos, D.,Kariotoglou, P. Tselfes, V., Hatzikraniotis, E., Fassolopoulos, G. &Kallery, M. (Eds.), *Science education research in the knowledge-based society*(pp. 383-393). Boston : Kluwer Academic.
- Vosniadou, S. (2013). Conceptual change in learning and instruction: The framework theory approach. In S. Vosniadou (Ed.), *International handbook on conceptual change*, 2nd ed. (pp. 11-30). New York: Routledge.

Affiliation and address information

Louis Trudel
Faculté d'éducation de l'université d'Ottawa
Pavillon Lamoureux
145, rue Jean-Jacques-Lussier
Ottawa, Ontario, Canada
K1N 6N5
ltrudel@uottawa.ca

Chapter 4

Physics Teaching and Learning at University Level

The Braced String, Dispersion and Polarization

Sergej Faletič

Faculty of mathematics and physics, University of Ljubljana, Slovenia and Poljane High School, Ljubljana, Slovenia

Abstract

In this article we examine a mechanical system that is sometimes called a *braced string* or a *Klein-Gordon string*. An example of it is a string hanging on elastic bands. We show that the system offers the opportunity to discuss dispersion - a topic rarely addressed in detail in introductory physics courses, yet very important for many observable phenomena and thought experiments, especially regarding information and energy transfer. The dispersion relation is known and we can even make calculations. Moreover, due to dispersion, the phase velocity of the wave polarized in the direction of the elastic bands is different than that of the wave polarized perpendicular to them. This gives rise to effects very similar to effects of birefringent materials, namely the change in polarization of the wave. We show that the system offers many opportunities to apply introductory level physics and mathematics knowledge to understand and describe the phenomena we encounter. We also show that since it is a mechanical system with clear dynamics, some phenomena can be discussed on a conceptual level without the employment of mathematical tools. We have conducted a pilot study on some of our students and it appears that the use of the tool indeed enhances the understanding of dispersion phenomena.

Keywords

waves, dispersion, teaching

1. Introduction

Dispersion is a topic that is very important, especially for conceptual understanding of energy and information transfer. Yet, the topic is rarely discussed in enough detail to provide the required experience base. One question that I encountered myself, and I also hear from numerous students is: The group velocity is often described as the velocity of the envelope of the wave. The envelope must come from the fact that we have components with different frequencies present in the wave. The envelope arises from their interference. But what with the first crest. The fastest crest does not have a wave in front of it to interfere with, so it should continue its propagation with phase velocity. Thus it could be used to transfer energy/information with phase velocity. The question is also relevant for the general public, as reports on materials with superluminal phase velocity appear in newspapers. The braced string clearly shows what happens to the first crest of a wave and to a pulse. This provides a visual and first-hand experience. We believe it is a system simple enough to discuss the phenomenon with limited mathematics, which is especially important for presenting science to the general public. Beilock and Willingham (2014) present a well documented overview on mathematical anxiety and how widespread it is, which is reason enough to avoid using it with general public. Moreover, even in a more formal setting, the constructivist theory emphasizes starting from the concrete towards the abstract. Therefore, we consider the system a valuable tool for teachers who teach the topic, those who may encounter this kind of questions from their students, and for experts often dealing with the general public.

In this article we examine how a pulse travels on a braced string. In literature I found the string itself has already been examined by Mouchet (2008), Bertozzi (2010) and Gravel and Gauthier (2011). All of them used it in conjunction with quantum mechanics, because its equation of motion is the Klein-Gordon equation. More on their suggestions can be found in the section *Further uses of the system*. None of them focused on dispersion and none report any evaluation of its effectiveness in class. We add to this by discussing the string itself, and its dispersion properties. We explain the shape using only conceptual considerations, then using a very abstract model of a wave inside an envelope, and finally by decomposing the pulse into Fourier components, which is the mathematically correct approach. We show that the phase and group velocities can be easily measured with video camera and compare all the results to theoretical values.

We devised a learning cycle resembling the ISLE cycle as suggested by Etkina and Van Heuvelen (2007) around the system focused on phase and group velocities and we show how our small sample of students approached the phenomenon. We will show that they arrived at the necessity for two velocities mostly on

their own. We will show that the mechanism that causes dispersion is simple enough to be discussed by students, and their comments offer some further insight into how the activity affected them. Finally, we briefly discuss the possibility to use the system to demonstrate and explain the change in polarization that occurs when a polarized wave travels in a medium with different phase velocities for different polarizations.

2. Theory

The braced string can be most concisely described as a system of a large number of strongly coupled oscillators (see figure 1). If we let the number of oscillators approach infinity and their mass and spring coefficient approach zero, we get a string 'braced' in springs, which is why Gravel and Gauthier called it a braced string.

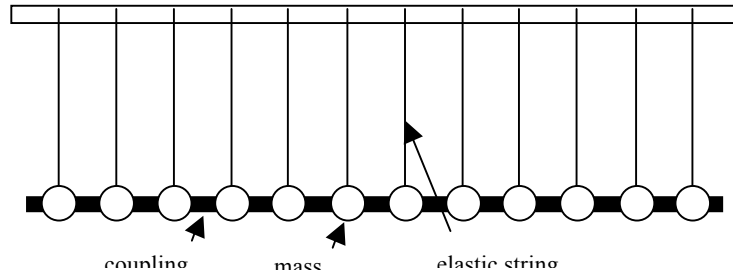

Figure 1. A sketch of a braced string.

The braced string is described by the Klein-Gordon equation

$$T \frac{\partial^2 y}{\partial x^2} - \frac{dK}{dx} y = \frac{dm}{dx} \frac{\partial^2 y}{\partial t^2} \quad (1)$$

Hence, Mouchet called it a Klein-Gordon string. Here y is the waveform (displacement from rest position), T , dK/dx and dm/dx are to be interpreted as generic parameters. We rewrite the equation in the form of differences

$$T\Delta x \frac{\Delta^2 y}{\Delta x^2} - Ky = m \frac{\partial^2 y}{\partial t^2} \quad , \quad (2)$$

which is the form used, if we want to view it as a system of coupled oscillators. It is also easier to understand, and produce experimentally. The discrete case of equation (2) approximates well the continuous one of equation (1), if the wavenumber is much smaller than $2\pi/\Delta x$. We can realize the braced string in many different ways: by coupled pendula, spring oscillators, torsional oscillators. In each case the parameters represent different physical quantities, but in all cases T has to do with the restoring force (or coupling), m has to do with inertia, and K is related to the natural frequency of one oscillator. The derivation and the meaning of quantities is in our opinion easier to understand for coupled spring oscillators. For this case, T is the coupling force between oscillators, m is the mass of one oscillator, Δx is the distance between oscillators, and K is the spring coefficient of each oscillator. We can quickly introduce

$$\omega_1 = \sqrt{K/m} \quad ,$$

which is the natural frequency of one oscillator.

We can derive the dispersion relation relatively easily. We assume the solution to be of the form

$$y(x,t) = (A \cos(kx) + B \sin(kx)) \cos(\omega t) \quad . \quad (3)$$

We insert this in equation (1) and we get the dispersion relation

$$k(\omega) = \frac{\omega}{c_0} \sqrt{1 - \left(\frac{\omega_1}{\omega}\right)^2} \quad . \quad (4)$$

Here ω is the driving frequency and $c_0 = (T\Delta x/m)^{1/2}$ would be the phase velocity on the same, but unbraced medium. With $c_{ph} = \omega/k$, we can quickly see that

$$c_{ph} = c_0 \left(1 - (\omega_1 / \omega)^2\right)^{-1/2} \quad (5)$$

The phase velocity thus always increases, if the string is braced.

3. Experiments

We used 9 weights of $m = 50\text{g}$ and the coupling springs had a coefficient of $(0.525 \pm 0.014)\text{ N/cm}$ and was connected to produce a force $T = (1.84 \pm 0.15)\text{ N}$. We measured $\omega_1 = (12.6 \pm 1.6)\text{ s}^{-1}$ directly via oscillations of the oscillators. On this medium we produced a pulse of duration approximately 0.27 s . The resulting shape was filmed and is shown at different times on figure 2. From this figure it is most clear that the crest we created with the pulse (seen at time 0.3 s) vanishes with distance and a trough that we have not created with the pulse appears in its stead (as seen at time 0.6 s). This answers the question, why we cannot relay energy or information with the fastest crest. The displacement vanishes. But can we explain why?

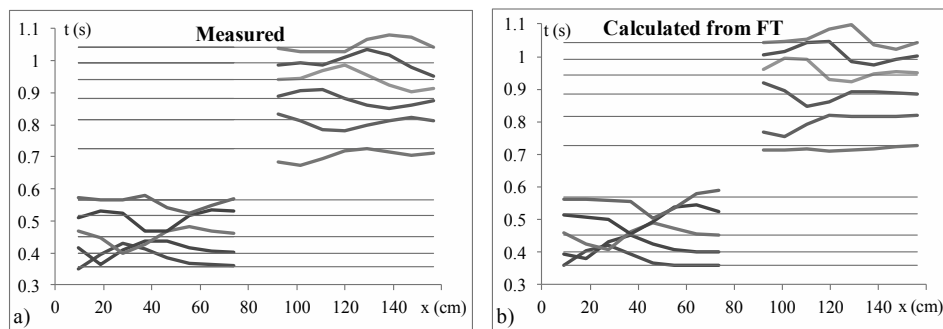

Figure 2. The shape of the pulse as it travels along the braced string. (a) is measured with a camera. The pulse was reflected at distance 90cm and the shapes at times above 0.7 s are appropriately transformed shapes of the reflected wave. The switching between crest and trough is clearly visible. (b) is the waveforms calculated via Fourier transform. The phase velocity appears a little lower, but there is good qualitative agreement.

4. Conceptual explanation.

We know that energy is transferred from one (let us call it A) to the next oscillator (let us call it B) via coupling. As oscillator A rises, it pulls behind itself oscillator B. Without bracing, B would rise to the same height as A. By then, A would already be on its way back and would again pull B behind itself. The displacement is transferred from A to B with a slight delay and that is what we see as a waving motion. Let us now consider the same situation with a braced string. Oscillator A rises and pulls behind itself oscillator B. A rises to a certain height and begins returning. By then, B has been raised to a certain height, but since the bracing strings provide an additional restoring force, the force from A is not enough to raise it to quite the same height as A was. The displacement of B is therefore a little lower than that of A was. Now A starts pulling B back down, and is assisted by the bracing strings. While A would be capable of returning B to its rest position, the bracing strings push it a little further. The displacement of B therefore becomes a little negative. Now, since B pulls up the next oscillator and B itself ended lower than A, the next one ends even lower. On the other hand, as B crossed towards negative values, it pulls the next towards even more negative values. The process continues. Once we have a full trough, the process repeats from trough to crest. To visualize this we programmed a computer simulation to simulate the forces on each bead. According to Steinberg et al. (1996), Zacharia and Anderson (2003), and Finkelstein et al. (2005), computer simulations can enhance students' conceptual understanding. We find our use of simulation is most similar to the use in Finkelstein et al. (2005), in the sense that we added the simulation to the real-life apparatus just to enable a more clear view, less troubleshooting and perhaps (something to consider for the future) visualization of actual forces in the process.

An abstract description

For those students who are already familiar with the concepts of envelopes, phase and group velocities, the process can be described as a wave travelling with phase velocity inside an envelope travelling with group velocity. This description fails for longer times as in reality the envelope spreads, which is not accounted for in this simple description. But the description is consistent with how phase and group velocities are usually

described for infinite travelling waves and it is a good thing that the description can be used also for pulses, even if with some limitations.

An explanation with Fourier transforms

The correct way to describe the phenomenon, and the way that offers most predictive value is by decomposing the pulse into its Fourier components. Each component then evolves as a perfect sinusoidal wave with a single frequency and the corresponding phase velocity. At any given time we can recompose the components and retrieve the shape of the pulse. This accounts both for the spreading of the envelope and for the switching of crests and troughs, as seen in figure 2b. Comparison with figure 2 shows that the theoretical shapes match well with the experimental ones. Some components naturally have frequencies lower than ω_1 . According to equation (4), these have an imaginary wavenumber. For an imaginary wavenumber, equation (3) returns an oscillating exponential shape. These components, thus, do not reach far from the origin.

5. Quantitative analysis

In this section we show that quantitative measurements are in good agreement with theoretically predicted values. We measured the phase velocity with two independent methods and group velocity with one.

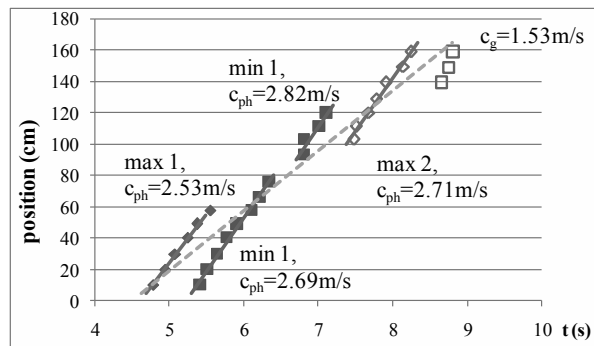

Figure 3. A graph of the position of the visible crests and troughs versus time. From this graph it is easy to see and determine the phase and group velocities.

Measuring from the video

The easiest way to analyze the motion is to follow the motion of the crests and troughs on the video. We plotted the position of the highest and lowest points of the waveform versus time for as long as we could discern them on the video. The result is shown on figure 3 along with fitted values for velocities. The graph clearly shows two relevant velocities. The phase velocity is the velocity with which the crest or trough travels, while the group velocity is related to how displacement travels regardless of its sign.

Measuring via standing waves

We can enclose the string between two rigid ends and produce standing waves on it. Since standing waves are due to interference, the positions of the crests and troughs will be relevant, therefore the phase velocity will be relevant. Also, a standing wave has one single frequency, so one single phase velocity. Once we measure the frequency of a particular mode, we can use equation $c_{ph} = \omega/k$ to calculate the phase velocity. It is interesting that with our setup we could only measure the second mode and above, because the first mode is at a frequency which produces imaginary wavenumbers.

Figure 4 shows measured and calculated velocities with different methods. They match quite well. In fact the phase and group velocities are statistically different and all the phase velocities, including the calculated one (hollow square) are statistically the same. The measured group velocity also matches the calculated value. These are expected results. We also see that the calculated velocity c_0 is between the phase and group velocities, again as expected.

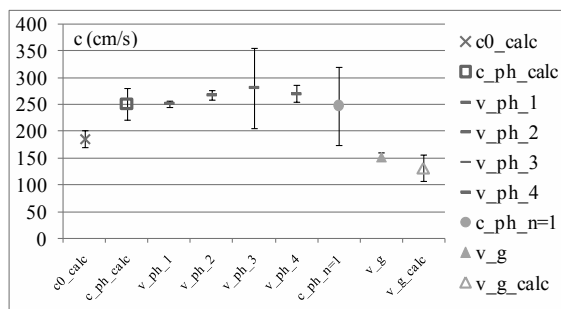

Figure 4. A graphic comparison of measured and calculated phase and group velocities.

6. The use of the system in class

We see the main value of the system in assisting physics teachers in explaining why a wave in dispersive medium cannot travel with the phase velocity. Not even the first crest or a pulse. We conducted a small-scale pilot study on pre-service teachers. For this purpose we constructed a system consisting of coupled rigid pendula (figure 5). We used wooden sticks for barbeque, and placed them at equal distances on an adhesive tape about 1.5cm wide, so that their center of mass was not on the adhesive tape. The tape provides coupling and the sticks act as rigid pendula. We chose this version because it resembles a torsional wave-machine, with which the students had prior experience, flipped into a vertical position. It can be produced cheaply, and in many numbers. It can also be quite long.

We structured the session as a learning cycle. We conducted the class with three students individually who have all been taught dispersion, phase and group velocities in traditional lectures about three years prior to this study. I first asked what they remembered about phase and group velocities. Two replied they remember hearing of it but nothing else. One produced a model resembling the envelope model, but could not identify the phase and group velocities. Then I asked them whether they were familiar with the torsional wave machine. All were familiar with it. Then I asked them what they expect should happen when they create a pulse on one end of the system. They all expected a travelling wave. Each produced the pulse. The pulse showed about three shifts between crest and trough on the length of the system. Two immediately observed that there was something strange about this pulse. One only observed that the pulse did indeed travel, but after prompting to explain in more detail how he expected it to travel, including the shape of the pulse, he also noticed the phenomenon.

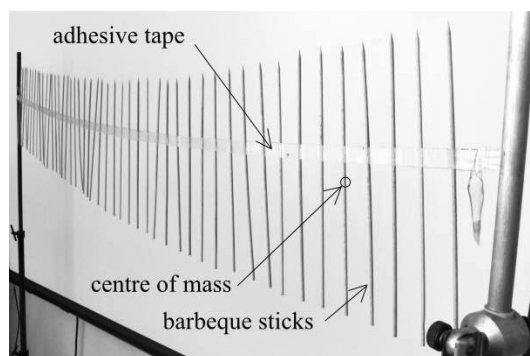

Figure 5. A simple Klein-Gordon system made from wooden (barbeque) sticks and adhesive tape.

Then I asked them to determine the velocity of the pulse. They all suggested filming the propagation and following the crests. We filmed it with two students while one used the computer simulation. The only reason for this was that we wanted to see, whether the system could still be analyzed, if a camera was not available. We plotted the position of the crest versus time. They all noticed that the crest disappeared. Then they suggested following the next crest when it formed. We did that. They observed that the graph was broken. The graph resembled strongly the one in figure 4. One also suggested following the troughs which we also did. Despite the graph being broken, all proceeded to determine the (phase) velocity by linearly fitting each crest or trough. They used different programs to do it: Vernier's Logger pro is handy because it allows tracing on the video, and many tools for fitting, but one chose Microsoft's Excel and did it just as well. This logging of data admittedly takes time, from 15 to 20 minutes, but the session was still completed

within 45 minutes twice and once within 50 minutes – we believe it can be reliably completed within 45 minutes once the procedure is polished. Once they determined the (phase) velocity, I asked them to predict when the pulse will reach the other side. Two realized the measured velocity would not give the answer while one predicted based on it. For the latter I asked him to produce the pulse again and time it. We also timed it on the video. He decided to time from when the first pendulum started to move to when the last pendulum started to move. The time was off by 2 seconds (10% of the travel time). We returned to the graphs and I asked him to show me what represents the time that he calculated on the graph. He correctly identified the time at the intersection of the linear fit with the position of the last pendulum. The value was in fact as he predicted. With this he realized the (phase) velocity was not the correct parameter to predict the propagation of the whole pulse. Next I asked them to find a velocity that would predict the motion of the whole pulse. All students initially insisted that they should attempt to write an equation for the broken line. I then asked them to make the simplest approximation – to find a single velocity that could approximately describe the motion of the entire pulse. Ideas on how to do this varied. One suggestion was to take the beginning of the disturbance. Another suggestion was to take the middle point of each crest/trough – the time when it was supposedly the largest. Yet another suggestion was to take the time between two most similar situations (time between two clear crests or two clear troughs). Yet another suggestion was to fit all the data together, but excluding the points when the crest and trough are both visible – simply decide whether it is a crest or a trough. We did all which they suggested and I told them also of the possibility to fit all the data as one set. All methods gave similar results, which were significantly slower than the phase velocity. The prediction of the travelling time of the pulse based on this (group) velocity was consistent with the measurement. After this we reflected on the fact that there are two velocities. I told them the proper names (phase and group) and we discussed what each means. The realization that there are two velocities and that the pulse travels slower than each crest in it was theirs. One commented that he has heard of this in lectures but he never really believed it happened in real life until he saw it. This might be interpreted as poor confidence in mathematics, something that we already suspected could happen, and we are pleased that the activity was able to reconcile the mathematics with the physics, at least for this student. Another student commented that the situation reminded him of a passenger that has to switch busses. While the bus travels fast, the waiting time between the busses causes the passenger to travel slower on average than the bus itself. While the activity at this stage was only meant to address the phase and group velocities, one student asked about the dynamics of what he observed. He was not satisfied with the description alone. He wanted the physical insight. For this purpose I started the computer simulation of the phenomenon. I explained the similarities between the real and the modelled system by pointing to the fact that for both systems the dispersion relation takes the same form. Observing this simulation he determined the forces on each bead during the motion, but he could not by himself arrive at any conclusion. I told him to compare the motion to the situation with no dispersion ($K = 0$). Then he realised the role of the additional forces in a similar way to what we described in *Conceptual explanation*. This result suggests that the computer simulation needs a little more work, if we want students to arrive at the conclusions alone. In accordance to suggestions in Finkelstein et al. (2005), we believe we should add the force diagrams on each bead to provide more insight than that which can be achieved simply with a frame-by-frame view of the video.

7. Further uses for the system

The system in figure 1 can be considered as a system of coupled spring oscillators, if the displacement is in the vertical direction, or as a system of coupled pendula, if the displacement is in the horizontal direction. The natural frequencies are different for the two different polarizations. This naturally gives rise to phenomena similar to birefringence. For a pulse polarized at an angle of 45° between horizontal and vertical, its polarization changes from linear to elliptical and back to linear at -45° as it travels along the medium. This has also been filmed and the video analysed. We do not wish to go into details here, so on figure 6 we just give the results of the measurements along with the results of the theoretical prediction calculated by time-evolving the Fourier components of the initial pulse. The natural frequency of the pendula was determined via equation $\omega_2 = (g/l)^{1/2}$, by measuring the length (l) of the bracing strings. Here g is the gravitational potential (equal to free-fall acceleration).

Further uses for the braced string in the context of quantum mechanics have been proposed by others. Mouchet (2008) used the string as a mechanical model of scattering, discussing in great detail a system of a single spring oscillator coupled to a Klein-Gordon string. Bertozzi (2010) used it to search for the possible meanings of the solution of the Klein-Gordon equation in the context of quantum field theory. Gravel and

Gauthier (2011) described the string and two related systems that they used to address the concept of mass in the quantum setting. I, myself also have suggestions, which I address in a different article¹.

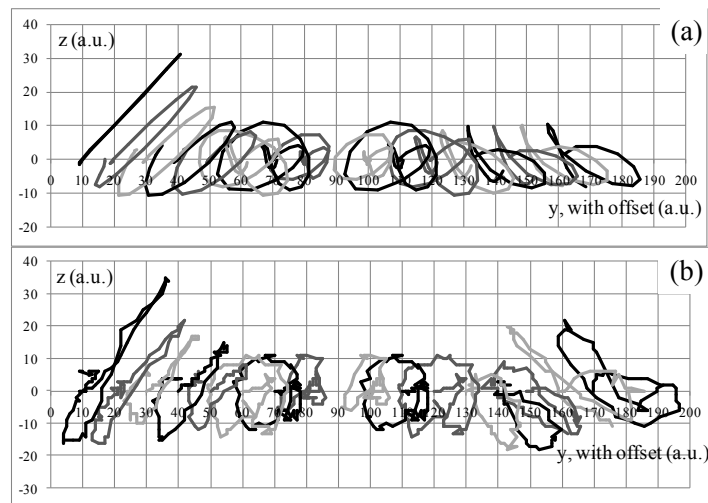

Figure 6. Comparison of polarization for an initial 45° pulse. (a) values calculated via Fourier transforms vs. (b) measured values. The two components of displacement are denoted z and y and are plotted for the duration of the pulse at that position along x . The y component is offset to indicate where along the x axis a particular polarization occurs.

8. Conclusions

We have shown that a braced string or a Klein-Gordon string can be used to discuss dispersion. Especially transient effect such as the first crest or a pulse. We see the didactical value in its clear dynamics. We have shown that students are able to realize the need for two velocities with minimal intervention and we have shown that with some intervention at least some are able to arrive at the dynamics of the system. We have shown that at least some students desire a real-life example of what they learn to strengthen their confidence in the formal derivations, and this system provides the experience.

It may be that the system has most didactical value, if used as a project or ISLE-like laboratory learning cycle where students can work in small groups. It provides many open ended tasks that students might solve in different ways (such as how to measure velocities, how to explain or describe the shape, etc.). Students will likely have different ideas that they can refine in discussion with their peers. All these learning opportunities might be missed in a more frontal setting. As a side benefit, the logging of data can be done a little faster in a group. We believe the topic is important enough, especially in the way it relates to information transfer, that it may even warrant replacing some other, more conventional laboratory tasks. The performance of students on a larger scale, and the learning results, however, remain to be investigated.

References

- Beilock, S. L. and Willingham, D. T. (2014). Math anxiety: can teachers help students reduce it? *Am. Educator* **38**, 2, 28-32.
- Bertozzi, E. (2010). Hunting the ghosts of a 'strictly quantum field': the Klein-Gordon equation, *Eur. J. Phys.* **31**, 1499.
- Etkina, E., and Van Heuvelen, A. (2007). Investigative Science Learning Environment - A Science Process Approach to Learning Physics. In Redish, E. F. and Cooney, P. J. (Ed.), *Research-Based Reform of University Physics*, American Association of Physics Teachers, College Park, MD, 2007, Reviews in PER Vol. 1, <<http://www.per-central.org/document/ServeFile.cfm?ID=4988>>.
- Finkelstein, N. D., Adams, W. K., Keller, C. J., Kohl, P. B., Perkins, K. K., Podolefsky, N. S., Reid, S. and LeMaster, R. (2005) When learning about the real world is better done virtually: A study of substituting computer simulations for laboratory equipment, *Phys. Rev. ST Phys. Educ. Res.* **1**, 010103.

¹ The contribution was presented at the GIREP-MPTL 2014 conference under the title *How close can we get waves to wavefunctions?* At the time of writing this article, the decision whether to include it in the proceedings was still pending.

- Gravel, P., Gauthier, C. (2011). Classical applications of the Klein-Gordon equation, *Am. J. Phys.* **79**, 447-453.
- Mouchet, A. (2008). Interaction with a field: a simple integrable model with backreaction, *Eur. J. Phys.* **29**, 1033.
- Steinberg, R. N., Oberem, G. E. and McDermott, L. C. (1996) Development of a computer-based tutorial on the photoelectric effect, *Am. J. Phys.* **64**, 1370.
- Zacharia, Z. and Anderson, O.R. (2003). The effects of an interactive computer-based simulation prior to performing a laboratory inquiry-based experiment on students' conceptual understanding of physics, *Am. J. Phys.* **71**, 618.

Affiliation and address information

Sergej Faletič
Department of Physics
Faculty of Mathematics and Physics
University of Ljubljana
Jadranska ulica 19
1000 Ljubljana, Slovenia
e-mail: sergej.faletic@fmf.uni-lj.si

How Close can we Get Waves to Wavefunctions, Including Potential?

Sergej Faletič

Faculty of mathematics and physics, University of Ljubljana, Slovenia and Poljane High School, Ljubljana, Slovenia

Abstract

In the following article we show that mechanical waves on a braced string can have the same shapes as important wavefunctions in introductory quantum mechanics. A braced string is a string with additional transversal springs that serve as external 'potential'. The aim is not to suggest teaching quantum mechanics with these analogies. Instead, the aim is to provide students with some additional relevant experience in wave mechanics before they are introduced to quantum mechanics. We show how this experience can be used in a constructivist sense as the basis for building quantum concepts. We consider energy transfer along such string and show that penetration of a wave into a region with high 'potential' is not unexpected. We also consider energy transfer between two such strings and show that it can appear point-like even though the wave is an extended object. We also suggest that applying quantization of energy transfer to wave phenomena can explain some of the more difficult to accept features of quantum mechanics.

Keywords

quantum mechanics, waves, teaching

1. Introduction

Introductory quantum mechanics introduces students to describing particles with wavefunctions. But by this time they usually have barely any experience with wave mechanics. So not only do they have to learn that 'particles' are not actually small balls, they also have to learn wave mechanics almost from the beginning. This naturally causes some problems.

Levrini et al. (2007) suggested from interviews with students that not understanding, but accepting quantum mechanics might be the biggest problem students face. We believe part of this is due to the fact that so far quantum objects have been always described to them as particles. Now suddenly they have to describe them as waves, yet they are not really familiar with how waves behave. The topics of impedance and 'potential' in the context of waves are barely ever discussed in introductory physics. Hobson (2013) suggested using only fields to talk about quantum mechanics and not even talking about particles. He did not discuss the didactical value of this approach, but he showed that using particles is not necessary to build a consistent quantum picture. Yet, he has not attempted to provide a wave experience for students to draw from. We attempt to remedy this by showing those features of classical wave mechanics that are relevant for the behaviour of wavefunctions. We believe that, if students are already familiar with wave mechanics, many features of wavefunction mechanics will already be familiar to them and they can focus on what quantum mechanics, specifically quantization of energy transfer, adds to that.

In the first part we discuss how to produce behaviour similar to that of the wavefunction. We introduce the *braced string* or the *Klein-Gordon string* and discuss its properties. Gravel and Gauthier (2011) discussed a similar system in connection with the Klein-Gordon equation but not the Schrödinger equation and potential. Bertozzi (2010) compared different systems described by the Klein-Gordon equation, among which he mentioned this mechanical one, but he focused more on the electromagnetic application and on how they can help us give meaning to quantities in quantum field theory. We instead suggest how they can help students learn quantum concepts at introductory level. In the second part we discuss point-like interaction of waves and energy transfer. We believe this is the reason why we still talk about particles in introductory quantum mechanics; because they are point-like objects that we associate with point-like energy transfer. Mouchet (2008) used this kind of system to produce a mechanical model of scattering which is also a point-like interaction, but he focused on the technical part and did not suggest a didactical use for the system. In the last part we suggest how adding quantization to the picture might reconcile waves and point-like interactions.

2. Theory

We started with the Schroedinger equation

$$-\frac{\hbar^2}{2m} \frac{\partial^2 \psi}{\partial x^2} + V(x)\psi = i\hbar \frac{\partial \psi}{\partial t} \quad , \quad (1)$$

where \hbar is the reduced Planck constant, m the mass of the particle being described, ψ is the wavefunction and V the potential. We asked ourselves what a similar form for a mechanical wave would be. The mathematical description would have to be of the following form.

$$T \frac{\partial^2 y}{\partial x^2} dx - dK(x)y = dm \frac{\partial^2 y}{\partial t^2} \quad . \quad (2)$$

We rewrite this equation in the form of differences because it is easier to understand and produce experimentally.

$$T\Delta x \frac{\Delta^2 y}{\Delta x^2} - K(x)y = \Delta m \frac{\partial^2 y}{\partial t^2} \quad . \quad (3)$$

The continuous case of equation (2) approximates well the discrete one of equation (3), if the wavenumber is much smaller than $2\pi/\Delta x$. Here, y is the waveform (displacement from rest position), T , K and Δm are to be interpreted as generic parameters. For different systems the parameters represent different physical quantities, but in all cases T has to do with the restoring force and Δm has to do with inertia. In the case of a string, or a system of springs and beads, which is the one we will use in the description, T is the tension, Δm is the mass of a bead, and Δx is the distance between the beads. Since the right-hand side of equation (3) represents mass times acceleration, all terms on the left-hand side are obviously forces. The second term is thus a force proportional to displacement. This can be a spring obeying Hooke's law and $K(x)$ is then the spring coefficient.

So all we have to do to introduce 'potential' in wave mechanics is add transversal springs to our medium. This is also consistent with what 'potential' means in quantum mechanics. It means that in this region part of the energy of the particle must be stored as potential energy due to some external field. Likewise in the case of waves, part of the energy of the medium must be stored as elastic potential energy of the external springs. This energy is returned to the medium when the springs relax, and it produces reflection effects. In fact, with such potential we can easily achieve energy reflection and produce standing waves.

Standing waves are particularly important, because they often form a basis and all other waves can be written as linear superpositions of the standing waves. Therefore, from here on we will only discuss standing waves. For standing waves the temporal part of the solution is known to be an oscillating term. The spatial part of equation (2), on the other hand, is exactly the same as its quantum counterpart. Therefore, the solutions are the same as for the appropriate quantum case. The standing waves should be of the same shape as the wavefunctions of the stationary states in quantum mechanics. We will not derive them here, but one can find them in many books on introductory quantum mechanics e.g. Schwabl (2007) on pages 49, 65 and 72 and on the internet. More technical details on the system can be found in Faletič (2015).

3. The discriminating quantity

For the simplest case of $K(x)$ being piecewise constant we can derive the dispersion relation. This gives some further insight. We assume the solution on each piece of the medium to be of the form

$$y_i(x, t) = (A_i \cos(k_i x) + B_i \sin(k_i x)) \cos(\omega t) \quad . \quad (4)$$

We insert this in equation (2) and we get

$$k(\omega) = \frac{\omega}{c_0} \sqrt{1 - \left(\frac{\omega_1}{\omega}\right)^2} \quad .$$

Here ω_1 represents the natural frequency of an oscillator made from one segment of the medium (Δm) and the spring attached to it. We will call this a *lone oscillator* and the medium can be described as a system of strongly coupled lone oscillators, but the description as a wave is more convenient for our purpose. It can be

seen that ω_1/ω determines whether the wavenumber k will be real or imaginary. If $\omega_1 < \omega$ (the natural frequency of the potential is lower than the frequency of the wave), k is real, and we get a wave with a different wavelength, which is always longer than in a free medium (figure 1c). If $\omega_1 > \omega$, k is imaginary, and we get an exponential shape. In fact, as figures 1 and 2 show, the tunnelling waveform and the finite potential well waveform can be both reproduced.

4. Experiments

We used a torsional wave-machine for the experiments. The wave equation in this case is somewhat different

$$D\Delta x^2 \frac{\Delta^2 \varphi}{\Delta x^2} - b(x)r(x)^2 \varphi = I_1 \frac{\partial^2 \varphi}{\partial t^2}.$$

Here D is the torsional coefficient of the restoring torsional mechanism (in most cases of wave-machines a wire that connects the rods), $b(x)$ is the coefficient of the spring connected to the rod at position x , $r(x)$ is the distance between the central wire and the point on the rod where the spring is attached. I_1 is the moment of inertia of that rod. The expression $b(x)r(x)^2$ acts as the external potential. $r(x)\varphi(x)$ is the vertical displacement at distance r , $b(x)r(x)\varphi(x)$ is the force due to the external spring and $b(x)r(x)^2\varphi(x)$ is the torque. The natural frequency of one oscillator of this form can be easily derived from Newton's law of motion

$$\omega_1(x)^2 = \frac{b(x)r(x)^2}{I_1}.$$

The freedom in choosing $r(x)$ allows us to use the same springs and change ω_1 by changing where they are attached to the rod. We used elastic strings (but we will continue to call them springs throughout this article) instead of springs. We are aware that they do not strictly follow Hooke's law, but they are far easier to acquire and work with. We will show that the results do not suffer from the choice.

Special waveforms

By positioning a number of springs on subsequent rods in the middle of the wave-machine we achieved a narrow potential barrier. We varied the excitation frequency so that ω_1/ω was either greater than or lower than one. Figures 1a through 1c show the results. As expected, for an imaginary k we get an exponential shape. For low frequencies all energy is reflected inside the potential (figure 1a). For a higher frequency but still below the threshold of imaginary k some energy is 'tunnelled' through the potential and a sinusoidal waveform with smaller amplitude appears on the other side (figure 1b). For a frequency above the threshold the shape inside the potential is sinusoidal with a longer wavelength (figure 1c).

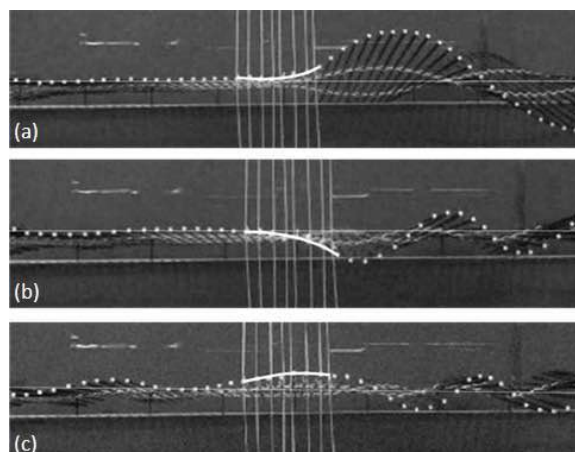

Figure 1. Waveforms in the 'tunnelling' setup. (a) The waveform at low excitation frequency. The shape inside the potential is exponential and it drops to insignificance before it reaches the other side of the potential. (b) The shape at a higher frequency but with still an imaginary k inside the potential. The shape does not drop to insignificance before it reaches the other side of the potential, therefore a wave with very small amplitude is visible on the other side. The wave might be a little difficult to discern on the static picture, but the oscillations are clearly visible in the real experiment. (c) For an even higher frequency k becomes real. The shape inside the potential is sinusoidal and the energy is transferred to the other side.

Besides these waveforms, we also tested the finite potential well by leaving the centre of the wave-machine without springs and adding springs to the sides of the wave-machine. In figure 2 we can see that the waveforms match well with the theoretical predictions, which are the same as the spatial parts of solutions of the Schrodinger equation. We also see the exponential tails penetrating the 'potential'.

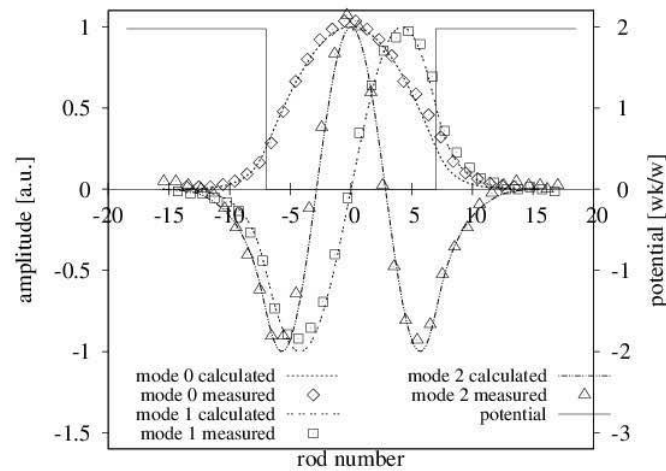

Figure 2. The shape of the experimental wave (points) and the theoretical prediction (lines) for the first three stationary states of a finite potential well. The shape of the potential is also shown.

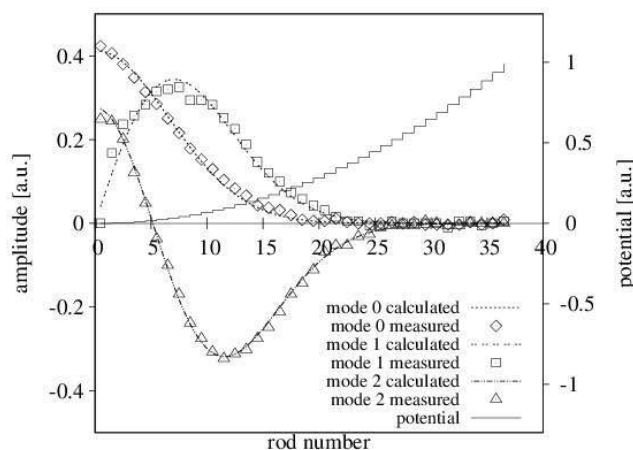

Figure 3. The shape of the experimental wave (points) and the theoretical prediction (lines) for the first three stationary states of a wave inside a parabolic potential (the shape of the piecewise constant approximation used is also shown). The waveforms are the same as the spatial part of the wavefunction in a quantum harmonic oscillator.

After realizing that the 'potential' is made from springs, we believe it is intuitive that some energy still gets transferred even into the region where displacement is hindered, but with each next segment less and less energy can be transferred, so the displacement approaches zero, while the energy gets reflected and produces a standing wave. From this, it is intuitive to conclude that only infinitely strong springs would prevent any displacement at all within the region.

The freedom in parameter $r(x)$ allows us to easily produce a parabolic potential by linearly increasing $r(x)$ with x . We did this, too, and produced waveforms consistent with wavefunctions of the quantum harmonic oscillator (figure 3).

We attempted the experiment with a different system, made of coupled pendula as the medium. The natural frequency of each pendulum provides the potential, while the coupling provides the waveform. On figure 4 we only show pictures to prove that the waveform of the finite potential well can be easily achieved also with this kind of system. Out of 10 pendula, three on each side had approximately half the length of the rest. The exponential tails are clearly visible.

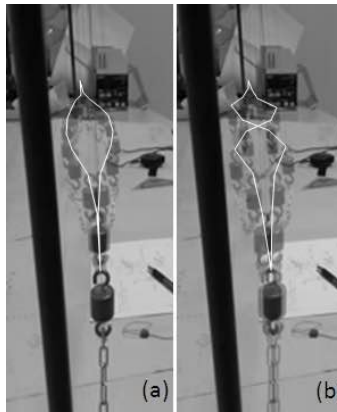

Figure 4. Two extreme positions of the standing wave, superimposed on the same picture for (a) the first and (b) the second stationary state of the finite potential well. The white lines are added to emphasize the shape of the waveform.

Energy transfer

We have shown that waves behave very similarly to wavefunctions in quantum mechanics. We believe that with this experience it also becomes intuitive why in a finite potential well the energy of the particle still penetrates the 'wall' to a degree, and why it is necessary to make infinitely strong springs (an infinite potential well), if we want the wavefunction to become zero at the 'wall'. With this, it is a natural question why do typical courses in quantum mechanics still talk about particles. We believe the reason is that when we observe interactions, which is all we can observe, they appear point-like, which is a feature more readily associated with particles than waves.

Here we show that waves can also exhibit point-like energy transfer. When we produce a wave, we typically do it by exciting only one segment of the medium and let the wave propagate. This interaction is very limited in space, point-like. Yet, it excites the whole wave. We, therefore, know that energy can be transferred to a wave in a point-like manner. Can it also be extracted from the wave this way? Yes. Especially with a wave-machine we frequently use viscous damping at the end to extract energy from the wave so it would appear as if it travels to infinity. To do this we often use a damper connected to the last rod of the wave-machine. Again, a very spatially bound interaction that yet extracts all the energy from the wave.

We have done experiments with the coupled pendula medium. We connected the whole medium to another pendulum via weak coupling as shown on figure 5. We observed and filmed the beats as the whole energy of the pendulum is transferred at one point-like interaction to the medium and back. We have thus proven that an energy transfer can occur between a pendulum and a wave at a specific point, and we believe there is no reason to doubt that it can occur in the same way between two waves. We have shown this with simulations and we intend to show it with an experiment. There is really no theoretical reason why it should not be possible. This suggests that we can expect point-like energy transfer also between two entities described with wavefunctions.



Figure 5. Coupled pendula can be used as a type of braced medium. The medium is made of pendula on strings coupled by a chain hanging from one pendulum to the next (A). On the bottom right side is the driving pendulum (B). A string (C) connects the string of the driving pendulum and one of the strings of the medium, and serves as coupling.

Does this point-like energy transfer between waves contain any further similarity with the quantum case? Yes. For example, it cannot be done in the nodes of the standing wave. This is similar to the fact that we cannot detect an interaction (find a particle) where its wavefunction (and consequently probability density) is zero. But, it can be done anywhere else. We hypothesized that it would be most efficient where the amplitude is the highest. To that end, we measured the beat frequency when the coupling was far from the peak of the antinode (at the third weight out of ten), and close to the peak of the antinode (at the fifth weight). For the first case, we got $(5.8 \pm 0.2) 10^{-3} \text{Hz}$, and for the second $(8.5 \pm 0.2) 10^{-3} \text{Hz}$. We took care to keep the coupling strength the same as much as possible. We also verified that there is only a slight dependence of beat frequency on initial amplitude of the pendulum, on the order of 5% or $0.4 10^{-3} \text{Hz}$, which is not enough to account for the measured difference. We still tried to keep the initial amplitude the same. We, therefore, conclude that the energy is indeed transferred faster (more energy transfer per unit time) when the coupling is closer to the peak of the antinode than when it is further from the peak.

As a side experiment we also confirmed that, if the frequency of the driving pendulum is set to the frequency of the second stationary state, it is in fact the second stationary state that is produced on the medium during energy transfer.

Quantization

To use this experience with quantum phenomena, we must introduce quantization of energy transfer, which is the most important feature of quantum mechanics that sets it apart from classical mechanics. In classical wave mechanics the energy is transferred over time, and we can transfer different amounts of energy at different positions. This allows us to sample the shape of the waveform. In the quantum world, the energy of one entire quantum must be transferred at once. Once the quantum is transferred, the state of the particle changes to a state with one less quantum of energy. The wavefunction changes accordingly. Therefore we cannot sample it by transferring energy from different positions, because as soon as one quantum is transferred the wavefunction changes and we would not be sampling the same wavefunction again. The only way to get statistics out of the situation and sample the entire wavefunction is to prepare a great number of identical wavefunctions and sample each once, hoping that the transfer will not occur all the time at the same position. That is exactly what quantum mechanics describes.

The quantum point-like transfer of energy means that it is also transferred in only one of all the possible positions (but never from the impossible ones - the nodes). How to account for different rates of transfer at different positions that we encountered in the classical case, if the energy of one entire quantum must be transferred at once? Through statistics. Over a longer time, it should occur less often that the energy is transferred at positions far from the peaks of the antinodes, and more often near the peaks. So, on average, there will be less energy transferred from places with lower amplitude. Thus, efficiency translates to probability. Since lower energy cannot be achieved with smaller packages, the only alternative is to make packages less frequent.

We end our discussion of quantization here. We are aware that this comparison probably has limitations, and we do not pretend to be able to show that all quantum behaviour, except quantization, is also exhibited by classical waves. We just wanted to show that much of it is, and set those features apart from features that are specifically quantum.

5. Conclusions and discussion of didactical value

We have shown that shapes such as we encounter with wavefunctions in quantum mechanics are inherent to wave mechanics, even classical. We have introduced external potential in the form of external springs that affect the shape of the waveform and the energy flux of the wave. We have shown that the discriminating quantity that determines the energy transfer through a potential and, therefore, the shape of the waveform is the ratio between the natural frequency of a segment of the medium, if it is considered as an independent oscillator, and the frequency of the wave. We have shown that waves can exhibit point-like interaction. We have compared all these features to features of quantum wavefunctions, but we do not suggest using them as an analogy to teach quantum mechanics. Instead, we suggest to use them as a foundation in a constructivist sense, while building a consistently quantum picture. We only hope to minimize the cognitive conflicts that arise from comparing particle behaviour to wave behaviour by showing that much of the differences between particles and waves are already present in classical physics. We have shown that classical waves already exhibit penetration into a potential that is too high and tunnelling. This is not what is new in the quantum world. We have also shown that classical waves already exhibit point-like interaction. This is also not what is

new. The real novelty comes from quantization. We, therefore, believe that the emphasis when teaching quantum mechanics should be on quantization: what are the changes that quantization brings to what we already know is wave behaviour. We believe this can help students understand the features specific to the quantum world better, and set them apart from what are features of all waves.

The described system is used as only a part of a larger short course on quantum mechanics for high school students. The course consists of other experiments and topics, but we will report here on the parts that are done with the system described here. We have tested this approach on two different groups of high school students: one group were second year students who chose 'optional physics' at the Poljane High School. These had two years of physics in primary school and were in the second year of a 70-hour-per-year course at high school. The other group were those who attend preparations for the International Physics Olympiad (IPhO). We have not yet any quantifiable results, so we can only report on our observations. We introduced the mechanical model after we showed the electron scattering experiment which we used to justify describing electrons with wave-like entities. They saw that with low frequencies the exponential tails occur and also that the tail gets longer with higher frequency and shorter with increased potential. After this they were able to predict what would be necessary to remove the tails: infinite potential. They have shown no surprise at the fact that tunnelling occurs with mechanical waves. This is encouraging since in our experience it causes big surprise when discussing it in the context of particles. On the topic of quantization, they were introduced to wave interference and then compared it to single photon interference. They learn in the context of the photoelectric effect that each photon transfers its entire energy to one electron. To reconcile the extended wave description of the photon with a point-like interaction, we show them the experiment with the pendulum transferring energy to the wave, and other point-like interaction, such as driving the wave at one end, which are very common for waves. After this, both groups were able to reinterpret the interference pattern as a probability pattern. The different beat frequency experiment described in *Energy transfer* was used to reinforce this interpretation: more joules per second must mean more photons per second, which must mean greater probability to interact at that point. We had the impression that students had no difficulty accepting the wave phenomena on their own. Quantization was a new concept to them, but they were able to use it and integrate it at least to a certain degree in the wave description. We view these points as positive achievements of the approach, although rigorous pedagogical study still remains to be done. We have collected some feedback, but it has not been analyzed yet. Apart from the IPhO group being able to learn faster, we have noticed no discernable differences between the groups. Individuals in both groups were able to use the acquired knowledge to make predictions about new phenomena. We presume the percentage of those able to do this would be higher in the IPhO group, but there were some in both groups. Again, a more rigorous study might show further differences.

We have presented a system that can set apart the inherently wave properties of wavefunctions from their strictly quantum properties and their interpretations. We have shown some positive observations in class and hope to do a more thorough study in the future.

References

- Bertozzi, E. (2010). Hunting the ghosts of a 'strictly quantum field': the Klein-Gordon equation, *Eur. J. Phys.* **31**, 1499.
- Etkina, E., and Van Heuvelen, A. (2007). Investigative Science Learning Environment - A Science Process Approach to Learning Physics. In Redish, E. F. and Cooney, P. J. (Ed.), *Research-Based Reform of University Physics*, American Association of Physics Teachers, College Park, MD, 2007, Reviews in PER Vol. 1, <<http://www.per-central.org/document/ServeFile.cfm?ID=4988>>.
- Faletič, S. (2015). A mechanical wave system to show waveforms similar to quantum mechanical wavefunctions in a potential, *Eur. J. Phys.* **36**, 035023
- Gravel, P., Gauthier, C. (2011). Classical applications of the Klein-Gordon equation, *Am. J. Phys.* **79**, 447-453.
- Mouchet, A. (2008). Interaction with a field: a simple integrable model with backreaction, *Eur. J. Phys.* **29**, 1033.
- Hobson, A. (2013). There are no particles, there are only fields, *Am. J. Phys.* **81(3)**, 211-223.
- Levrini, O., Fantini, P., Pecori, B. (2007). "The problem is not understanding the theory, but accepting it": a study on students' difficulties in coping with quantum physics. *Proceedings of the GIREP-EPEC Conference 2007, Frontiers of physics education*, Zlatni rez, Rijeka, 319-324.
- Schwabl, F. (2007). *Quantum mechanics*. 1992 4th ed. Springer-Verlag Berlin Heidelberg.

Affiliation and address information

Sergej Faletič
Department of Physics
Faculty of Mathematics and Physics
University of Ljubljana
Jadranska ulica 19
1000 Ljubljana, Slovenia
e-mail: sergej.faletic@fmf.uni-lj.si

How Can Future European Physics Studies Lead to Innovative Competences and Stimulate Entrepreneurial Behaviour?

Hendrik Ferdinande

Universiteit Gent, Belgium

Abstract

Tertiary-level education and physics studies are under increasing pressure to respond to the appropriate skills demands generated in a rapidly changing labour market. After a short introduction on the *competence-based description* of study programmes (e.g. Dublin descriptors, ‘Bologna Process’, Tuning) the EPS (*European Physical Society*) documents on physics bachelor, master and doctoral studies, described in learning outcomes or competences are presented. Recent research on skills for innovation in the Science, Technology, Engineering & Mathematics (STEM) field are focused on, as well as an example of a competency model and a master programme with a *minor on economics and management* with accompanying support. The complexity and uncertainty of the society and the economy require physics studies to *continuously adapt* while upholding quality standards. A European permanent *think tank of experts on physics studies* (of which part of the members could be renewed every two or three years), established with the help of the national member societies in the EPS and based on a mixture of good practices in the different countries, could represent a great help and should be aimed at. Embryos could be found in the HOPE network and the EPS Forum on Physics & Society.

Keywords

Physics studies, innovative competences, entrepreneurial behaviour

1. Modernization of physics studies

In the last two decades tertiary-level education in general and physics studies in particular are undergoing significant changes as a result of the advent of digital technology. As digitalization grows, we can predict a significant impact on employment and skills in the decades ahead. A detailed look at the medium to long-term prospects for the world of work has been reported [Störmer, E.*et al.* 2014] and four scenarios, identifying and describing complex visions of this future, have been explored. Hence future European physics curricula should respond to the appropriate skills demands generated in this rapidly changing labour market. Education providers are recommended “*to collaborate closely with employers to support them in achieving their business and skills objectives to ensure provision is responsive to their needs and forward-looking in a competitive learning market*” [Störmer, E.*et al.* 2014]. Furthermore one should realize that these curricula should be foreseen for students who belong to the Generation Z, i.e. the cohort of people born after the Millennial Generation. Precisely this generation will also be challenged by the following global reality: “*By 2020, China alone will account for 29 per cent of all the university graduates in the world aged 25-34. In absolute numbers, that will mean there will be as many Chinese graduates in that age group as in the entire US labour force*” [OECD 2012]. In an increasing competitive environment for international student recruitment Higher Education Institutions (HEIs) need also to accommodate to the needs and behaviour of these international Millennials [Chang, L., Schulmann, P. & Lu, Z. 2014]. Recently a High-Level Group for the Modernization of Higher Education was set up by European Commissioner Androulla Vassiliou and reported [European Commission 2014] on new modes of learning and teaching in higher education with a set of 15 recommendations. The E.C. will offer funding through the ERASMUS+ programme to policy-makers and education providers to take forward those recommendations.

The competence-based description of study programmes was initiated in Continental Europe by the work of the JQI [Joint Quality Initiative 2004] on the “*Shared ‘Dublin’ Descriptors for Short, First, Second & Third Cycle Awards*”, where a competency is defined as: “*a dynamic combination of attributes - with respect to knowledge and its application, to attitudes and responsibilities - that describes the learning outcomes of an educational programme*”. This description was used intensively in the *Bologna Process* which was launched in 1999 by the Ministers of Education and university leaders of 29 countries. The process has further developed into a major Higher Education (HE) reform

encompassing 46 countries, not aiming to harmonize national educational systems but rather to provide tools to connect them and to promote transparency in the emerging European Higher Education Area (EHEA). A year later the project ‘*Tuning Educational Structures in Europe*’ (for short ‘Tuning’) [Tuning Educational Structures in Europe, 2000] linked the political objectives of the Bologna Process to the HE sector and developed into an approach to (re-)designing, develop, implement, evaluate and enhance quality first-, second- and third-cycle degree programmes using the competence-based description. The Tuning idea has been disseminated not only in Europe, but also in Tuning Africa, Tuning AHELO, TuCAHEA (Central Asian Higher Education Area) (namely the states of KA, KY, TA, TU, UZ), Tuning Georgia, Tuning *América Latina*, Tuning Russia and even in Tuning USA, while Tuning Japan is in the starting phase. Building further on the Tuning methodology the *European Physical Society* (EPS) worked out three documents [EPS 2009] on European Specifications for Physics Programmes. This series of brochures covers the bachelor or first-cycle or European Qualification Framework (EQF) level 6, master or second- cycle or EQF level 7 and doctorate or third-cycle level or EQF level 8, as one of the three priorities in the Bologna Process. They provide a means to describe the characteristics of the physics study programmes on a European level in competences terms. The brochures also represent general expectations of the standards for the award of qualifications at the given level and articulate the attributes and capabilities – i.e. the learning outcomes - that those possessing such qualifications should be able to demonstrate. Standardization in the competences terminology will hopefully be reached in 2017 with the multilingual (25 languages) classification [ESCO 2013] of European Skills, Competences, Qualifications and Occupations.

2. Research on skills for innovation in the STEM field

Recently there has been a boom of research to investigate the kind of innovative skills and competences needed for students in the STEM fields. The *Centre for Educational Research and Innovation* (CERI) of the OECD in Paris, under the leadership of Stéphan Vincent-Lancrin, has been very active in the framework of its ‘Innovation Strategy for Education and Training’. At a conference on ‘Educating for Innovative Societies’ F. Kowalski from the Colorado School of Mines (Col, US) presented work [Kowalski, F. 2012] on how to enhance creativity in an undergraduate physics class. This research shows that innovation requires new additional competences as behavioural traits/habits of minds such as being curious, seeking patterns, being persistent; and it requires motivation. International data on students skills for innovative economies reveal [Avvisati, F., Jacotin, G. & Vincent-Lancrin, S. 2013] that ‘*the mastery of one’s own field is not among the very top skills that differentiate the most highly innovative from less innovative professionals*’ and concluded by highlighting the importance of a competence-based approach to curriculum and pedagogy. A study on innovative technology-supported pedagogical models in STEM education [Kärkkäinen, K. & Vincent-Lancrin, S. 2013] pinpointed: educational gaming, online laboratories, technology-supported collaborations, real-time formative assessment and skills-based assessment. The HP-Catalyst Initiative was used here as a case study. An excellent tool for the practitioner with a measurement agenda to an innovation and improvement strategy in education can be found in the recent book: ‘*Measuring Innovation in Education: A New Perspective*’ [Vincent-Lancrin, 2014]. Finally we want to mention the research under investigation by the Working Group 2 of the ‘Horizons in Physics Education’ network project [HOPE 2013], funded by the European Commission (E.C.) aiming e.g. to obtain detailed information, including examples of current practice from physics departments on the specific innovation, entrepreneurship and enterprise competences, that they include in the educational experiences and learning opportunities offered to their physics students. Hence a survey was set up among the partner HEIs to investigate how important the following skills, attributes and abilities for physics graduates are, who follow a path other than a research career in physics: goals and ambitions, self-confidence, perseverance, internal control, action orientation, innovation and creativity, persuasion and negotiation, approach to management, decision making, responsibility, networking, opportunity recognition, financial and business awareness, market and commercial awareness

3. Case study: UGent

Under the impulse of the ‘Bologna Process’ the Flemish HE was reformed starting with the academic year 2003/04. Ghent University (*Universiteit Gent* or *UGent* for short) in Gent, Belgium developed a comprehensive set (‘*UGent Competency Model*’) of skills training in four clusters: communication, career management, research & valorization and leadership & efficiency. *UGent* has categorized different skills according to different purposes in order to attain a more holistic training, which was mentioned as a “noteworthy example” [Byrne, J., et al. 2013]. The traditional standard (integrated 4-year master) programme, where physics graduates followed a path leading to a research career in physics was reformed. The new 3-

year bachelor & 2-year master curriculum in Physics & Astronomy, offering three possible minor tracks (research, education or economics and management) (a common structure for all 'hard' science disciplines in the Faculty of Sciences) delivered the first graduates at the end of the academic year 2008/09. The number of students graduating from 2008/09 till 2012/13 (i.e. five cohorts) according to the type of minor chosen are shown in Table 1. Taking into account that this programme only exists for five years and that the cohort of physics students is rather small, the 15 % entrepreneurial minor represents a relative success. In the two master years (120 ECTS) of the minor 'economics & management', the students have to choose from a set of 13 elective entrepreneurial courses (max 30 ECTS credits).

Table 1. Total number of students in M.S. Physics & Astronomy at *UGent* graduating in the period from academic year 2008/09 till 2012/2013 according to the type of minor chosen

type of minor	number of students
research	91
education	6
economics & management	14

Ghent University has a strong focus on creativity and was the first university in Flanders & Belgium to stimulate student-entrepreneurship. *Universiteit Gent* created a special statute for student-entrepreneurs which allow the students more study flexibility in order to combine easier studying and launching a start-up enterprise. The '*Dare to venture*' [Durf Ondernemen 2011] expertise centre for entrepreneurship in *UGent*, founded in 2011, has grown steadily both in personnel and number of beginning student-entrepreneurs. The programme received international recognition when it won recently the award for best concept at the UIIN Entrepreneurial Universities in Madrid. Students can receive feedback on their innovative idea and additional coaching to start their company for free as long as they are *UGent* students. They can also join the events and hands-on workshops for student-entrepreneurs.

'*Dare to venture*' does not focus on the students only, but wants to incorporate entrepreneurship in the courses. Lecturers are encouraged taking part in training organized by Coneect. This international network of universities, supported by the E.C. [Coneect 2013] offers interactive training courses for academic entrepreneurship teachers. In interdisciplinary teams, best-practice entrepreneurship education is delivered by award-winning international experts, coaches and trainers. *UGent* alumni have built up history in entrepreneurship with some of them having co-founded globally recognized companies, starting as spin outs from their HEI. *TechTransfer* assists the *UGent* graduates aiming to become entrepreneurs through a team of specialists: ipatorneys, lawyers, business developers and financial experts.

The '*Education Innovation Unit*' of the Faculty of Sciences provides logistics support for teaching innovation: preparation, capture, assembling, and publication of web lectures on Minerva/YouTube using Camtasia Studio software and for the online coupled assignments Curious software.

A wealth of information on emerging technologies used in HE learning and teaching can be found in the excellent, yearly-updated *New Media Consortium* brochure [Johnson, L. *et al* 2014]. Supported by an international expert panel, this project identified a series of topics (key trends, significant challenges, important developments) very likely to impact educational technology planning and decision making.

4. European coordination of Physics Studies by *athink tank*

A general view with complete, consistent statistical information on physics in general and physics education in particular, including its policies, for all of the States in the USA is provided and regularly updated by the APS (American Physical Society) and the AAPT (American Association of Physics Teachers) within the AIP (American Institute of Physics). It is timely that the EPS (European Physical Society) should be able to mimic this for - at least - all the States of the European Union, possibly for all the states of its 42 member-societies.

In the frame of the ERASMUS+ (2014/20) programme the continuation of the academic/thematic/multilateral network HOPE (Horizons in Physics Education) (2013/16) (an initiative not anymore extendable after 2016) [HOPE 2013] could be realized by applying to the E.C., i.e. the Education, Audiovisual & Cultural Executive Agency (EAC EA), for a parallel series of more topical follow-up projects/activities to (the present four working groups [WGs] of) HOPE. In other to avoid overlap and to ensure complementarity, these initiatives should be coordinated in a European context.

Hence my plea for a European (official) body ('think tank') to be established with the help of the [Physics Education Division (PED) of the] European Physical Society (EPS) via its 42 member 'National Physical Societies' and its recently established EPS Office in Brussels. Indeed, the EPS, being a partner in the HOPE network, expressed its interest by organizing the 6th EPS 'Forum Physics & Society' on 'Improving the Image of Physics', in Beograd [RS] in October 2014. Furthermore, partial views/information (related e.g. to WG1 of HOPE) at the national/regional level exist in the largest European national member-societies, e.g. the excellent, yearly-updated statistics on beginning and graduating student numbers by the 'Konferenz der Fachbereiche Physik' (KFP) of the 'Deutsche Physikalische Gesellschaft' (DPG) and the excellent support of the teaching and learning of physics by the 'Stimulating Physics Network' of the 'Institute of Physics' (IOP). By this way the good national initiatives with respect to stimulating young people becoming physicists and the statistics on physics students numbers could be (harmonized) (or even standardized or) spread over the whole of Europe.

In a bottom-up approach some thousand HEIs found a similar think tank in the 'European University Association', created out of the Conference of the European National Rectors' Conferences, while - in a top-down approach - the European Schoolnet forms a similar network of 31 European Ministries of Education, with the aim to bring innovation in teaching and learning to their key stakeholders-practitioners. The European Physics Education think tank should be a sustainable and permanent body consisting of (ideal 42) national/(eventually starting with) regional representatives (of which part of the members could be renewed every two or three years) from all European countries. We will concentrate all our efforts making this 'dream' coming true.

References

- Avvisati, F., Jacotin, G. & Vincent-Lancrin, S., (2013) *Educating Higher Education Students for Innovative Economies: What International Data Tell*, TJHE **1**, 223-40
- Byrne, J., Jørgensen, T. & Loukkola, T. (2013) *Quality Assurance in Doctoral Education - results of the ARDE project*, EUA Publications, Brussels
- Chang, L., Schulmann, P. & Lu, Z. (2014) *Bridging the Digital Divide: Segmenting and Recruiting International Millennial Students*, WES Research Report 06, New York <http://www.wes.org/RAS>
- Coneect (2013) *Educating Entrepreneurship Educators* Fachhochschule München <http://www.coneeect.eu/index.htm>
- Durf Ondernemen (2011) 'Dare to venture' Ghent University <http://durfondernemen.ugent.be/>
- European Commission (2014) *Report to the European Commission on New modes of learning and teaching in higher education* Publications of the E.U., Luxemburg http://ec.europa.eu/education/library/reports/modernisation-universities_en.pdf
- EPS (European Physical Society) (2009) *European Specifications for Physics bachelor, master or doctoral Programmes*, EPS Studies, Mulhouse http://www.eps.org/?page=policy_studies
- ESCO (2013) *European Skills, Competences, Qualifications and Occupations* <https://ec.europa.eu/esco/home;jsessionid=XGVrTQ8NP6LVpQt5ytJQjqfS4TrnyjnkbpvjD2nJW3TrkFQ6DQfX!-650281964!1393573101491>
- HOPE (*Horizons in Physics Education*) (2013), Université Pierre et Marie Curie, Paris <http://hopenetwork.eu/>
- Joint Quality Initiative (2004) *Shared 'Dublin' Descriptors for Short, First, Second & Third Cycle Awards* http://paginas.fe.up.pt/~sfeyo/Docs_SFA_Bologna/120_Ref%20Doc_20041018%20%5BJQIG%20Dublin%20Descriptors%5D.pdf
- Johnson, L., Adams Becker, S., Estrada & V. Freeman, A. (2014) *NMC Horizon Report: 2014 Higher Education Edition* The New Media Consortium, Austin, Texas
- Kärkkäinen, K. & Vincent-Lancrin, S. (2013) *Sparkling Innovation in STEM Education with Technology and Collaboration*, OECD Education Working Papers, OECD Publishing, Paris
- Kowalski, F. (2012) *Promoting creativity in physics undergraduates*. In *Educating for Innovative Societies. Conference Summary Report* EDU/CERI/CD6, Paris

OECD (2012) *Education Indicators in Focus*, OECD Publishing, Paris.

<http://www.oecd.org/edu/50495363.pdf>

Störmer, E., Patscha, C., Prendergast, J., Daheim, C., Rhisiart, M., Glover, P. & Beck, H. (2014) *The Future of Work: Jobs and Skills in 2030*. Evidence Report 84 UKCES, London www.ukces.org.uk/thefutureofwork

Tuning Educational Structures in Europe(2000) Deusto & Groningen University, Bilbao <http://www.unideusto.org/tuningeu/>

Vincent-Lancrin, S. (2014) *Measuring Innovation in Education: A New Perspective*, CERIOECD, OECD Publishing, Paris

Affiliation and address information

Hendrik Ferdinande

Department of Physics & Astronomy

Ghent University

Proeftuinstraat 86

9000 Gent, Belgium

e-mail: hendrik.ferdinande@ugent.be

Investigating Physics Teaching and Learning at University

Jenaro Guisasola¹, Mieke De Cock², Stephen Kanim³, Lana Ivanjek⁴, Kristina Zuza¹, Laurens Bollen², Paul van Kampen⁵.

¹University of the Basque Country, Spain;

²University of Leuven - KU Leuven, Belgium;

³New Mexico State University;

⁴University of Zagreb, Croatia;

⁵CASTeL and School of Physical Sciences, Dublin City University, Ireland

Abstract

Invited symposium organized by PERU GIREP Thematic Group.

Most of the initiatives taken by the European Union and by countries internationally in the field of science education focus on the primary and secondary levels of education, and relatively few reports have analysed the state of science education at Higher Education. Research in science education, and in particular in physics education, has shown repeatedly that the way teachers teach in primary and secondary school is strongly influenced by their own prior experience as students. The education that future professionals, such as scientists, engineers and science teachers, receive at University is worthy of study, because it allows us to investigate student learning, and because of more rigorous treatment of physics topics at the university level. For these reasons, it seems appropriate to identify, analyse and provide or suggest solutions to the problems of teaching and learning related to the university physics curriculum. In this symposium, we present examples of physics education research from different countries that is focused on physics topics

Keywords

Physics Education Research (PER), university education, students' difficulties in learning specific topics, analysis of teaching practice based on research results.

1. Introduction

The Physics Education Research (PER) community consists of physicists who apply logical rigor and standards of evidence to physics education. Research on Physics Education is not only concerned with innovation in teaching but also with the analysis of the process of teaching and learning based on empirical evidence. In the 1980s, the first research papers concerning Physics Education Research (PER) were published in the American Journal of Physics. In the 1990s, the European Journal of Physics also started to publish studies on PER. In 2005, the international community of researchers in physics education established its identity as a distinct research community with the creation of a new journal, Physical Review Special Topics-Physics Education Research (PRST-PER). Finally, in 2013, GIREP decided to support the field of physics education research at the university level by proposing the GIREP Thematic Group PERU (Physics Education Research at University Level). This symposium is the first outcome of this GIREP initiative.

Research in Physics Education at the university level has focused mostly on introductory/entry-level physics courses. (Recently, research interest in upper-level courses has been increasing rapidly, as described by Paul van Kampen later in this paper.) Areas of active investigation in Physics Education Research at the University level are diverse, and include investigations into (1) specific topical difficulties within physics; (2) student learning of problem solving; (3) student epistemologies and their effect on learning; (4) student use of mathematics in physics; (5) student learning of laboratory practices and of reasoning from evidence; (6) the development of an identity as a scientist during university education. Just as a physics investigation in materials science has practical technological outcomes, investigations into student learning often result in research-based curricular materials, and many Physics Education researchers also work on curricular development and on measuring the effectiveness of curricular modifications. Examples of these investigations into student learning and of instructional materials developed on the basis of this research include Hsu et al, 2004, Guisasola et al, 2010, Hieggelke et al, 2013, and McDermott, 2001.

This paper describes and discusses some examples of studies on teaching and learning of specific topics at university level. In particular, two of the contributions deal with students' conceptual knowledge in topics of

electromagnetism and modern physics, while a third study looks at students' struggles with deriving meaning from physics equations.

2. Research focus on topic-oriented demands

Students' preparation for using mathematics in introductory physics

The study presented by Stephen Kanim describes an investigation into *students' preparation for using mathematics in introductory physics*. In typical introductory courses, proportional relationships are ubiquitous, starting with definitions of velocity and acceleration in one dimension in the first few weeks of the course. Since students in introductory physics have had extensive instruction and practice in the use of proportions and of simple algebraic expressions over many years, it is reasonable for instructors to assume that proportional reasoning should not be a source of difficulty. However, this is not the case: while students may be able to perform *procedures* involving ratio and proportion successfully, the research conducted by Stephen Kanim at New Mexico State University, Suzanne Brahmia at Rutgers University, and Andrew Boudreaux at Western Washington University shows that a large fraction of these students cannot reason about these procedures in the ways expected of them in physics.

As part of this study we have identified six components of proportional reasoning that we think are required for fluent use and interpretation of ratio quantities in physics. These components are provisional, and are based on physics education and mathematics education research results that describe students' difficulties with mathematics in physics; on interviews that we have conducted with students about physical situations requiring proportional reasoning; and on our judgment about the types of reasoning that we would like our students to be able to do about proportions (both in physics and in general). They are (1) recognizing ratio as an appropriate measure; (2) verbal interpretation of a ratio; (3) construction of a ratio to characterize a physical system or phenomenon; (4) applying a ratio to make quantitative predictions about novel situations; (5) translating between different representations of direct proportions; and (6) Reasoning about situations where relationships are not direct proportions.

For each of these six components, we have developed a set of questions in multiple contexts intended to probe student fluency. Initial versions of these questions were free-response, and after analysis of student responses we developed multiple-choice versions. Here we illustrate the type of question for a few of the components, as well as data from administration of these questions as pre- and post-tests in large classes.

As described in Simon and Blume (1994), many people inappropriately use differences when ratios are more relevant, or fail to recognize that a given ratio quantity is actually a measure of something rather than an assigned index. One example of questions we have asked that probes whether students use proportion when appropriate is the building squareness question:

You are riding in an airplane. Below you see three rectangular buildings with the rooftop dimensions:

Building A: 77 ft by 93 ft

Building B: 51 ft by 64 ft

Building C: 96 ft by 150 ft

You are interested in how close the shapes of the rooftops of the buildings are to being square. You decide to rank them by "squareness," from *most* square to *least* square. Which of the following choices is the best ranking?

- (a) A, B, C (b) B, A, C (c) C, A, B (d) C, B, A (e) B, C, A

Students who decide based on the ratio of lengths of the sides will choose (a); students who decide based on the difference in lengths will choose (b). When we asked this as a pretest question, only 21% of 770 students in an introductory calculus-based course intended for engineering majors chose (a), while 70% chose (b). At the end of one semester of physics instruction, results didn't change, with 19% choosing (a).

Given two related and varying quantities in a physical system, a ratio can often be formed from these quantities that is invariant. For example, the mass and volume of different quantities of a liquid can be combined to form an invariant density. We would like our students to be able to construct the appropriate ratio of these two varying quantities. Most often the error made is to construct the reciprocal. One question we have asked to diagnose this skill is shown:

A block suspended by a spring is made to bob up and down. The motion repeats itself over and

over. You find that B bobs occur in 10 seconds. To figure out the number of seconds required for a single bob, you should:

- a. Divide B by 10 b. Divide 10 by B c. Multiply B by 10 d. None of the above

Of 533 students, 37% correctly answered that the number of seconds required is $10/B$, with 60% constructing the reciprocal $B/10$. One skill that physicists often use to check whether they have constructed an appropriate ratio is to check the units. Many of our students have not developed this skill sufficiently, as a basic check shows the most popular answer to be incorrect.

We have asked a variety of questions that focus on non-procedural aspects of proportional reasoning similar to the ones above across all six proportional reasoning components. Some generalizations emerge: (1) Student performance with individual components is highly context-dependent, with students exhibiting much better performance in familiar contexts than in unfamiliar ones. For example, when asked to compare densities of blocks of different sizes made up of identical material, about 85% can answer correctly; when asked an isomorphic question about charge density the success rate drops to about 55%. (2) Students are less successful answering questions with variables than without, with success rates on individual questions dropping 10% - 20% when a number is replaced with a variable. These results are consistent with results reported by Torigoe and Gladding (2010) when they compared questions asked with variables and questions asked with numbers. (3) Densities and ratios involving time are ubiquitous in physics, yet they seem to be particularly difficult for students.

The general sense that has emerged from this study is one of the fragility of students' mathematical knowledge – even for students in engineering and science majors at relatively selective universities. Many students have learned mathematics as a set of procedures, with little time and focus given to conceptualization of mathematical notions and processes. These students struggle with application and interpretation of proportional reasoning to physical quantities. In a standard introductory physics course, students are introduced to new quantities in unfamiliar contexts. Often these quantities are defined as ratios: density, velocity, acceleration, spring constant, coefficient of friction, impulse, electric field, electric potential, capacitance, heat capacity, frequency, are only a few. As instructors, we expect that – since they have seen ratios and proportions for many years in their mathematics classes – these definitions will be straightforward. However, our results indicate that while students may do well on questions posed in a familiar way, with familiar contexts, and with numbers, performance drops when variables are used, when the context is less familiar, or when they are asked to reason about proportions in ways they have not experienced. As a result, it is easy for students to become overwhelmed by the ways that mathematics is used in physics.

Moreover, exposure to a semester of physics apparently does little to strengthen this understanding or to develop fluency with use of proportions. By and large, results for the questions we have asked are about the same after a semester of using ratios and proportions in physics courses as they were at the beginning of the semester. If we are to improve student fluency with mathematical reasoning in physical contexts (and we believe that this should be a major goal of an introductory physics course) then we need to better understand how students think about mathematics, and we need to develop curricular materials that explicitly address students' mathematical difficulties in the context of physics.

University students' difficulties with the role of experimental set-up in the process of spectra formation

The research presented by Lana Ivanjek focuses on *University students' difficulties with the role of experimental set-up in the process of spectra formation*. The structure and formation of spectra are a part of university and secondary school curricula both in Croatia and in the United States. Systematic investigation of students' understanding of atomic spectra was conducted among 1,000 science majors in introductory physics courses at the University of Zagreb, Croatia (L. Ivanjek and M. Planinić) and the University of Washington, USA (P. Shaffer and L. McDermott). The research had two aims: 1) to explore the extent to which university students are able to relate the wavelength of spectral lines to the transitions of electrons between energy levels in an atom, and 2) to explore the extent to which students recognize the conditions under which discrete line spectra are formed (or not).

In the first part of the study (Ivanjek et al, 2015a) we have investigated university student difficulties with energy levels and transitions. During that investigation, it became clear that many students had an incomplete or incorrect understanding of how energy levels and transitions of electrons between them are related to discrete line spectra. When asked about the connection between energy levels and spectral lines, many

students did not seem to recognize that each spectral line is a result of a transition of an electron between two energy levels. There was a strong tendency to associate each spectral line with one energy level. Even students who recognized that each spectral line involves two different energy levels often did not have a correct model for the emission of light. We designed the tutorial, *Atomic spectra*, to help address the most common difficulties that we identified in the research. The tutorial guides students through an inductive process of finding the relationship between the energy levels in an atom and the spectral lines that are observed. In the process, the tutorial explicitly addresses specific difficulties, in particular, the tendency to treat spectral lines as if they had a 1-to-1 correspondence with the energy levels. The assessment of the tutorial indicates that the instructional strategy used in the tutorial can be effective for many students. The post-tests probe student ability to apply concepts and reasoning to situations that differ from those in the tutorial and that require a more complicated chain of reasoning to answer. Comparisons with results from simpler pretest questions indicate that the tutorial has helped many students significantly improve their understanding of atomic transitions.

The focus of the second part of the study (Ivanjek et al, 2015b) is student understanding of the role of the experimental setup in formation of a line spectrum. In the first stage, semi-structured demonstration interviews were conducted. Based on the insights from the interviews, two questions that probed that aspect of student understanding were constructed and administered to students. The data were obtained from students at University of Zagreb and at University of Washington. The students at University of Zagreb included two populations: second year physics majors in an introductory calculus-based physics course (N = 50) and junior physics majors (N = 98). The second-year students had completed calculus, General Physics 1 – 3 (mechanics, electromagnetism, waves, and optics) during their first year and were enrolled in General Physics 4, which covers thermal and modern physics. The juniors had completed a course on quantum mechanics. Most of the UW students (N = 660) were in the standard introductory calculus-based course (UW Intro). The others (N = 85) were in an ‘honors’ section (UW Honors). All had completed mechanics, electromagnetism, waves, optics, and were beginning to study modern physics. Instruction was supplemented by weekly tutorials.

Already during the interviews with the nine junior physics majors at the University of Zagreb it was noticed that they struggle with the role of different parts of experimental setup. The results from written questions demonstrate that difficulties are widespread. In the written questions, that were given after the lectures on the spectroscopy, only between 20 % and 30 % of the students recognized that the type of the light source is critical for the formation of a line spectrum. Students were often treating a prism as if it always yielded a continuous spectrum, treating spectral lines as if they were always visible, and most of them were confusing discrete line spectra with diffraction patterns. In their explanations, many student answers suggested a belief that light passing through a prism yields a continuous spectrum no matter what the light source. Students also incorrectly stated that narrowing the slit through which the light passes before reaching the prism and replacing the prism by a diffraction grating would make continuous spectrum become discrete. They did not seem to be distinguishing between discrete spectra and diffraction patterns. The following answers from students in the introductory physics course demonstrate this difficulty:

“The grating would make the light that passes it discontinuous so the spectrum on the screen will become discrete.”

“Narrowing the slit would create a wider beam so it would spread out the image on the screen creating a discrete pattern.”

Results from our investigation of student understanding of spectra have been used to develop instructional materials for introductory physics courses. The materials were designed to address student difficulties with basic spectroscopic experiments. Three different instructional materials were developed: tutorial, tutorial homework and an online spectra application for homework. All of the materials guide students through different experiments with different light sources, slit, prism, and optical grating. Students predict what they would observe on the screen in different experimental set-ups. The main goal of these materials is to help students to distinguish between diffraction pattern and discrete spectrum and to recognize the role of the different parts of the experimental set-up in formation of spectrum. The results from the post-tests demonstrate a need for improved instructional materials. There is also a need to create laboratory-based, instructional materials on spectroscopy for prospective and practicing precollege teachers with a focus on how the spectra are formed.

The specific difficulties described are symptomatic of more general problems. The errors made by the students indicate that many failed to recognize that discrete emission spectra are associated with light composed of only a finite number of wavelengths. Even though discrete spectra are typically introduced to help motivate the idea of energy levels and transitions of electrons between them, only few students seemed to understand the connection.

Many students thought that continuous and discrete emission spectra can be transformed one-into-the-other by making changes to the optical instruments that are used to observe them. The responses suggested a wide variety of difficulties associated with the optical instruments themselves. At a more general level, however, they indicated a failure of students to understand that a discrete spectrum is associated with light that has a finite set of wavelengths.

Characterizing university students' use of the electromotive force concept in electromagnetism

The aim of the study presented by Kristina Zuza, *Characterizing university students' use of the electromotive force concept in electromagnetism*, was to investigate and analyse the difficulties that students in the first years of university encounter when they try to comprehend the concept of electromotive force (emf) in contexts in which it is generated by electromagnetic induction (EMI). This study is a follow-up to previous research by Garzón et al. (2014), which looks at the problems faced by university students in trying to grasp the concept of emf in the context of transitory currents and resistive direct-current circuits. The research is a collaborative study among the University of the Basque Country (K. Zuza and J. Guisasola), the University of Leuven (L. Bollen and M. De Cock) and Dublin City University (P. van Kampen).

In a previous study (Garzón et al 2014), we discussed the importance of students learning the difference between emf and potential difference. Most teachers in mechanics differentiate clearly between work and energy, but in the teaching of concepts like emf (work per charge unit) and potential difference (potential energy per charge unit) an explicit distinction is not always made. It is this lack of conceptual differentiation that can often lead to confusion among students. Moreover, in a context in which Electromagnetic Induction (EMI) is caused by a magnetic field that is changing in time or by the movement of a conductor in a magnetic field, the work of moving the charges is carried out by 'non-conservative' forces, and so the concept of potential difference cannot be defined whenever the circuit in which the induction is produced is a closed one. Potential differences in induction phenomena can only be defined in open circuits in whose terminals the charges are grouped together and a Coulombic electric field is generated.

This study sets out to investigate students' comprehension of emf generated in electromagnetic induction phenomena. In particular, we wish to answer the following research questions: i) What is the students' understanding of the concept of emf after instruction in electromagnetic induction? ii) Do students distinguish between emf and potential difference concepts in induced current circuits?

To find out what undergraduate students have understood about the concept of emf in Electromagnetism, engineering and physics students from Spain, Belgium and Ireland, were given a questionnaire after they had studied the subject in class. The research was carried out at the University of the Basque Country (UPV/EHU), at the University of Leuven (KUL) and at Dublin City University (DCU) over the last two years. All first-year students had at least done one or two years of physics at high school and they received a semester of teaching on introductory electromagnetism. The electromagnetic induction chapter is taught for about 8 lecture-hours of this course. Lectures were given by experienced teachers in the Physics Department. The students who participated in this study were from three different countries. However, in the methodology we used, which consisted of identifying categories and accounting for them, we followed the theory of phenomenography, which shows how different ways of perceiving and understanding reality (that is to say, concepts and associated ways of reasoning) can be considered as categories of the description of reality (Marton, 1981).

In this brief description of the research, responses to one question are discussed. The question was designed to investigate students' ideas about emf in circuits in which the electric current is generated by electromagnetic induction. This question was included in a broader questionnaire, which is not the focus of this study. The question presents a conducting coil with a surface area S of 0.012 m^2 and a resistance of 5Ω is positioned between the poles of an electromagnet that produces a uniformly changing magnetic field for which $dB/dt=0.025 \text{ Tesla/s}$. This is a situation that is familiar to students in academic contexts and is studied in many textbooks for introductory physics courses. The students were firstly asked whether or not a potential difference is induced, and to explain their answer (question a). Secondly, students were asked whether or not a current I is induced; if so, they have to explain how they would calculate it (question b). To answer this question successfully, the students have to calculate the EMF induced from Faraday-Lenz's Law

($\epsilon = -d\Phi/dt$), taking into account that as there is no variation in area, the flux variation will be due entirely to the temporal variation in the magnetic field ($d\Phi/dt = SdB/dt$).

The results obtained are shown in Table 1 below. Although the students' curriculum in the three universities is similar, it is not the aim of this study to make comparisons or rankings. What this study seeks to identify are the students' main thinking patterns when interpreting the concepts of EMF and potential difference and to see whether or not there are similarities in the responses collected in the different countries.

Table 1. The results obtained in each of the universities as percentages and the categories to which the various types of response were assigned.

Category of description	UPV/EHU		KUL		DCU	
	a	b	a	b	a	b
A. Correct understanding of emf in electromagnetic induction context	0	2	0	28	10	0
B. No explicit distinction between emf and pd but ideas from the scientific model are used	7	25	5	22	10	17
C. emf and pd are mixed up	17	6	40	13	17	3
D. incorrect application of formulae/laws	27	30	18	12	27	23
E. no answers/no sense	51	36	37	25	36	57

This is ongoing research and so we only present here some remarks about the above questions and from the results of previous research about the electromotive force concept and students' conceptions. As can be seen in table 1, even after classroom instruction, only a minority (less than 10% of the students) had a sufficient comprehension of electromotive force in the context of EMI. Incomplete or incorrect lines of reasoning were identified that were common among students from all three countries. About one third of the students interpreted EMI phenomena correctly, but tended not to explain the difference between emf and potential difference or offered a rationale for their answers that was incomplete (category B). Around 30% of the students demonstrated an inadequate level of comprehension and confused the concepts of emf and potential difference in their explanations (category C). Approximately 20% of students resorted to rote memorization of laws and definitions to respond in a meaningless way (category D). Students' difficulties seem to be strongly linked to the absence of an analysis of the type of force that carries out the work in EMI phenomena. In this regard, most students still do not clearly understand the usefulness of concepts of potential difference and emf in situations involving electromagnetic induced current. Finally, our "explanatory categories" approach to students' knowledge implies that the learning difficulties found occur in a generalized way and not in a single country.

3. A view on international physics education research at the advanced university level

Paul van Kampen from Dublin City University presented an overview of the state of art on PER at advanced university level. The vast majority of university PER studies have been carried out at the level of introductory physics courses, and at a local level.

PER interventions have taken place along a continuum ranging from structured to open inquiry. At the structured end (see e.g. McDermott, 2014), the curriculum developer prescribes the procedure. Typically a syllabus is covered in a linear process, one concept at a time. The teacher presents questions in a neatly tidied setting that have a predetermined outcome. These questions are typically discussed by students in a small-group setting to foster discussion, and the teacher facilitates through semi-Socratic questioning. The focus tends to be on the cognitive domain, especially on developing formalized thinking structures to foster conceptual understanding. At the more open end of the spectrum (see e.g. Duch, 1995), a syllabus tends to be covered in a non-linear fashion, with several concepts being tackled at once. The teacher typically presents a contextual problem that often does not have a predetermined outcome, and students may influence the procedures they use. Learning here tends to take place in a small-group setting, with rotating roles assigned (Collaborative Learning). Focus is less on conceptual understanding and more on students organizing knowledge and developing research skills, and learning takes place in the cognitive, social, and affective domains.

The question is, how to advance from this solid base to advanced university level? Since the turn of the century this field has been growing, with particular attention being paid to learning of electrodynamics, classical mechanics, quantum mechanics, and laboratory work (especially on electronics). However, this is still a nascent area of research, and difficulties in the cognitive domain to date still are under-researched. It should be a challenging area: not only do students encounter new conceptual and mathematical difficulties with new degrees of difficulty, they also need to combine skills and knowledge previously acquired in a more isolated manner. Almost no research exists on the affective domain.

In a pioneering article, Ambrose (2004) explored some possible directions of PER research at the advanced level. To discuss two examples: (1) in the context of a falling object with air resistance, where a differential equation must be set up and solved, he found that well-known findings from introductory level PER still apply: for example, students who spontaneously drew free-body diagrams did better, and confusion between velocity and acceleration was still rife. (2) in the context of a graphical representation of a vector field, he found that students struggled to apply the Stokes theorem correctly and that the visual cue of seeing vectors “curl around” a current-carrying wire led them to predict that the curl was non-zero along the path rather than at the wire. While the second type of research is likely to arouse interest among students and teachers alike, it is debatable whether there will be much interest beyond the PER community in persisting difficulties from the introductory level.

As for moving beyond the local level, there are two obvious avenues to explore, both of which build on existing knowledge. Firstly, to simply extend published results and combine them to make an international study. At the (semi-)quantitative end, one may generally expect that similar reasoning patterns will be found but with different prevalences, and that new reasoning patterns may be unearthed. While this may not be a glamorous undertaking, there is potentially much value in this kind of research in terms of validating or establishing generalisability and mitigating against publication bias (see e.g. Ioannidis, 2005). Secondly, to carry out research internationally from the start, and obtain a deeper understanding of the kind of reasoning a much more varied student population employ (see e.g. Garzón et al, 2014).

Where to go from here? We would propose that to build successfully on our knowledge gained at the introductory level, we need to engage in interdisciplinary developmental research that inter-relates design, development and application with research findings. This requires pedagogical knowledge of the teaching and learning of physics and mathematics, the epistemology of physics, science-technology-society relationships, and results of domain-specific physics education research. Specifically, we would advocate the development of student-centred active learning strategies in a small-group setting using multiple methodologies: quantitative methods (e.g. items to be evaluated numerically by students), semi-quantitative analysis of written responses, and qualitative tools such as explain-aloud interviews with students. To include as broad a range of students as possible, this research should take place in multiple institutions. The richness and diversity in culture, language, and education systems would make Europe an ideal place for this type of research to grow.

4. Discussion and final remarks

In the symposium, different contributions in PER at university level were presented. These talks showed some commonalities, some differences and raised some questions or issues for discussion.

All contributions in the symposium showed high-quality and rigorous *research* in PER at university level. Whereas Paul van Kampen’s contribution considered the state of PER at the advanced level, the other presentations focused on the introductory level, as does most published physics education research at higher education level. Moreover, all these contributions gave some insight in student difficulties. A lot has been written already, but it seems that we are still not there with our understanding of student difficulties, even at the introductory level! Although ‘student problems’ could be seen as a ‘common theme’, the different presentations focused on different topics (emf, atomic spectra, proportional reasoning), but all contributions presented results from different universities and as such tried to go beyond local impact.

During the talks, it became clear that student ideas were studied with different methods. In the work on emf, open questions were presented to students and categories of description were constructed bottom up from the data. The proportional reasoning abilities of the students were studied by analyzing student answers on carefully constructed multiple choice questions in which possible errors were put as an alternative by the researchers. Understanding of atomic spectra was studied by interviewing students, and asking both open and multiple choice questions. In this presentation, impact of newly developed learning materials was also discussed. This brings us to open questions and issues for discussion, as one could wonder also for the

research on emf and proportional reasoning what kind of learning materials will be developed and how these will be evaluated?

Concerning emf, it is clear that students do not distinguish the concepts of emf and potential difference. Are we sure they understand potential difference? Is there a difference between physics majors and engineering students?

Referring to the work of Stephen Kanim and coworkers, it is not clear whether it is possible to define a ‘measure of proportional reasoning’ and whether this correlates with ‘physics performance’?

Related to the work on atomic spectra and student understanding of the experimental set-up, it seems that even when studying lab work and experiments, the focus remains on the ‘theoretical’ or maybe conceptual understanding. Don’t we need to get insight in the process of experimenting itself and if so, how could we study this role of experimental physics?

This symposium organized by the PERU-GIREP Special Interest Group aimed to present examples of high-quality research in physics education at university level and raised some issues for discussion and further research. PERU will accept contributions covering the full range of experimental and theoretical research related to the teaching and/or learning of physics. As shown in the overview presented by Paul van Kampen and the discussion developed by Mieke De Cock, we would like to experiment with developing themed ‘issues’ on topics of interest to the PER community at university level. PER has the potential to continue to influence the dialog and investment in educational research within the disciplines of Science and Engineering.

Of course, PERU can only succeed with the help of people like you contributing and attending the symposium. If you are interested, please send me a note with your contact information and your area of expertise. Let me know if you have suggestions for a themed issue. We always welcome your suggestions, comments, and constructive criticism. You can email me at [Jenaro.guisasola @ ehu.es](mailto:Jenaro.guisasola@ehu.es) and see the web site <https://girep.org/thematic-groups/peru.html>

References

- Ambrose, B.S. (2004). Investigating student understanding in intermediate mechanics: Identifying the need for a tutorial approach to instruction. *American Journal of Physics* 72, 453-459.
- Duch B. (1995). <http://www.udel.edu/pbl/curric/acc12c.html>
- Garzón, I., De Cock, M., Zuza, K., van Kampen, P. & Guisasola, J. (2014) Probing university students’ understanding of electromotive force in electricity, *American Journal of Physics* 82, 72-76.
- Guisasola, J., Almudi, J.M. and Zuza, K. (2010). The design and evaluation of an instructional sequence on Ampere’s law, *American Journal of Physics* 78, 1207-1217.
- Hieggelke, C.J., Kanim, S., Maloney, D.P., T. O’Kuma, T.L. (2013) *TIPERs: Sensemaking Tasks for Introductory Physics*. Pearson Series in Educational Innovation: Student Resources for Physics.
- Hsu, L., Brewster, E., Foster, T.M. & Harper, K.A. (2004). Resource letter RPS-1: Research in problem solving. *American Journal of Physics* 72, 1147-1156.
- Ioannidis, J.P.A. (2005). Why Most Published Research Findings Are False. *PLoS Medicine* 2 (8): e124.
- Ivanjek L., Shaffer P.S., McDermott L.C., Planinic M., and Veza D., (2015a) Research as a guide for curriculum development: An example from introductory spectroscopy. I. Identifying student difficulties with atomic emission spectra *American Journal of Physics* 83, 85-91.
- Ivanjek L., Shaffer P.S., McDermott L.C., Planinic M., and Veza D., (2015b) Research as a guide for curriculum development: An example from introductory spectroscopy. II. Addressing student difficulties with atomic emission spectra, *American Journal of Physics* 83, 171-178.
- Marton, F. (1981) Phenomenography: Describing conceptions of the world around us, *Instructional Science* 10, 177-200.
- McDermott L.C. (2001) Oersted Medal Lecture 2001: “Physics Education Research—The Key to Student Learning. *American Journal of Physics* 69, 1127-1137
- McDermott L.C. (2014). Melba Newell Phillips Medal Lecture 2013: Discipline-Based Education Research—A View From Physics. *American Journal of Physics* 82, 729-741.
- Simon, M. A., & Blume, G. W. (1994). Mathematical modeling as a component of understanding ratio-as-measure: A study of prospective elementary teachers. *The Journal of Mathematical Behavior*, 13(2), 183-197.

Torigoe, Eugene T., and Gary E. Gladding. (2010) Connecting symbolic difficulties with failure in physics. *American Journal of Physics* 79, 133-140.

Video Analysis Based Tasks in Physics

Peter Hockicko¹, Katarína Pažická²

¹ *Department of Physics, Faculty of Electrical Engineering, University of Žilina, Slovakia*

² *Institute of Foreign Languages, University of Žilina, Slovakia*

Abstract

Unlike tasks from printed textbooks, video analysis based tasks in physics do not incorporate either all necessary data to solve a problem or a procedure and a way how to find a solution to a task. The role of students in video analysis is to realize necessary physical characteristics, to choose a suitable way to a problem solution and from the relations among physical quantities to find a solution to a task. The tasks can be considered being the problem solving tasks with a well-defined problem and according to Bloom's taxonomy of cognitive domain they require higher level solution – mostly application, analysis and synthesis. Many of the video analysis based tasks are suitable also for the Physics lessons at grammar or secondary schools as there is no need to be aware of the integral and differential equations to be successful in solving them. On the other hand, it is also possible to demonstrate secondary school students, by a simple mathematical analysis, the use of integrals and derivatives in physics. The use of video analysis based tasks in physics can significantly affect the differences in the knowledge when students solving traditional tasks from printed textbook.

This paper presents initial research results of using video analysis based tasks in the educational process of the students of the Faculty of Civil Engineering at the University of Žilina in Žilina. We represent the research methodology, the form of results' processing and their evaluation. In the end we report on the research results and the comparison of a control and the experimental group that has used the method of video analysis as well as of a group comprising of grammar school students.

Keywords

Video-analysis, paired Student's t-test, F-test

1. Introduction

In previous contributions to "Creative Physics Teacher" conference we have already presented that the students' notion of the real physical processes is not correct (Hockicko, Rochovská, 2013). This led us to the production of a video set, by means of which we explained physical laws in lectures and realised video analysis in seminars (Hockicko, 2013, 2014). We have decided to test the effectiveness of the given teaching method using standard statistics methods. We designed a test which covered such questions that grammar school students (secondary school graduates), as well as students applying for the university studies, could answer (questions were taken from the former Monitor tests). The test was given to students both at the beginning and at the end of the semester. First year students of the Faculty of Civil Engineering at the University of Žilina in Žilina had the possibility to participate in physics lectures in the summer semester and to receive tuition in mechanics (kinematics, dynamics, rigid body, liquids, oscillations), gravitational field, thermics and thermodynamics, while not explicitly discussing answers to the test questions. At the same time students participated in laboratory and calculation seminars; they were divided into two groups in the calculation seminars: students in standard classroom formed the control groups (3) (solving equations by standard methods), and students learning in the IT classroom formed the experimental groups (2) (solving equations by means of video analysis), in every group there were about 10 – 20 students.

2. Video-analysis by means of tracker

All we need for a video analysis is a camera (mobile phone, tablet) to prepare motion files - video experiments. With the help of a high-speed camera and the program Tracker students can study certain motion in detail. They can observe various characteristics of the motion and learn the basics of classical physics while having fun. Camera used (Casio Exilim Ex-FH25) doesn't have to be a professional high-

speed camera, we just need the one that allows us to record videos at various frames per second (30, 120, 240, 420 and 1000 fps).

The Tracker itself offers time dependencies of 22 physical quantities (and/or we can define other) and data processing by means of graphs and tables. From the number of frames per second (30 fps or 120 fps usually) the time is deduced ($\Delta t = 0.033\text{ s}$ or $\Delta t = 0.0083\text{ s}$) while the position can be measured in two dimensions (x , y) using a calibrated video image. The autotracking function in this program allows accurate tracking without a mouse. The studied motion can be divided into two parts: the horizontal component and the vertical component (Fig. 1). These two components can be analysed individually and the results can consequently be combined to describe the total motion ($x(t)$, $y(t)$, $v_x(t)$, $v_y(t)$, $a_x(t)$, $a_y(t)$).

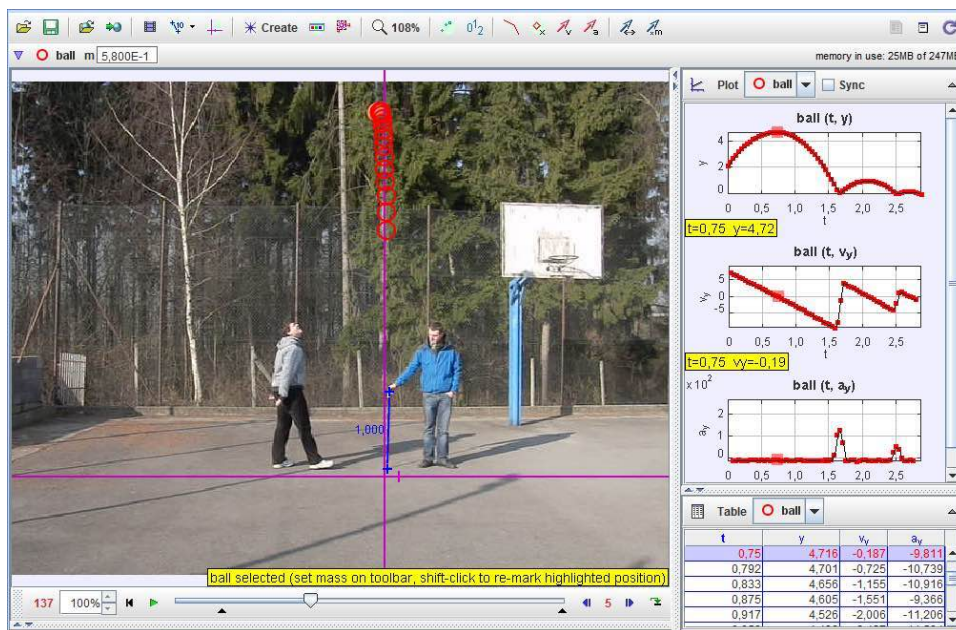

Figure 1. Video analysis of a thrown ball in y-direction using program Tracker

Figure one illustrates the task assigned to students - analyse the motion of a ball after throwing it into the air. Find the expression for the speed and the position of the ball as a function of time (the effect of air resistance has been considered to be negligible). What is the acceleration/deceleration of the ball in different positions (in move up of the ball, in maximum position and move down). By means Data Tool students applied infinitesimal calculus and the program calculated velocity and acceleration from the time changes in different positions. The students could fit the time dependencies of position, velocity, acceleration and other time variables using the tool. It itself provides data analysis, including automatic or manual curve fitting of all or any selected subset of data (Hockicko 2012).

Program Tracker offers two types of models: analytic and dynamic. The analytic one defines position functions of time, while the dynamic one defines force functions and initial conditions for numerical solvers. Figure 2 shows how the students have analysed the motion of the ball after throwing it and defined position functions of time and force functions with initial conditions in two directions. From these models it can be seen that the students have thought about the accelerated motion (with free-fall acceleration) in the vertical direction. The only force acting on the ball was the force of gravity (the effect of air resistance has been considered to be negligible).

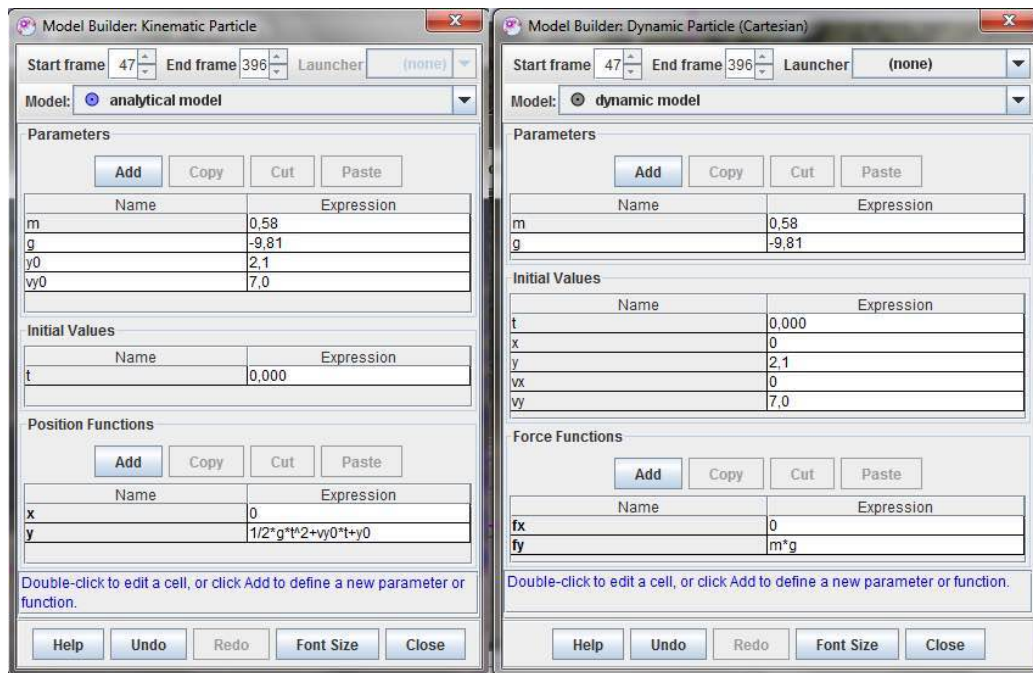

Figure 2. Analytic and dynamic models of motion with initial conditions

The following section provides statistical processing of results as well as an example of a video-analysis based lesson.

3. Analysis and tests evaluation

The pre-test was carried out at the beginning of the summer semester of 2013. 123 students took part in the test during the introductory seminar; the test took 20-30 minutes. 109 students (77 % of boys and 23% of girls at the age of 19 – 20) took part in the same test, the post-test, at the end of the semester. Students were answering by means of computer, each student solving the same number of questions; however, to avoid cheating the order of questions as well as the order of multiple choice answers were generated at random. Test results were collected in a database and subsequently stored for further processing. Lecturers were acquainted with the pre-test results the next week, mostly with wrong answers, so afterwards they could adapt their lectures so that they were able to interact with students' misconceptions. (see Figure 3 with the percentage share of individual answers).

Example:

Test question no. 8 What does not determine the amount of the frictional force?

- (A) the size of the contact area, (B) a body's mass,
 (C) the material of bodies being in contact (D) the gravity of Earth

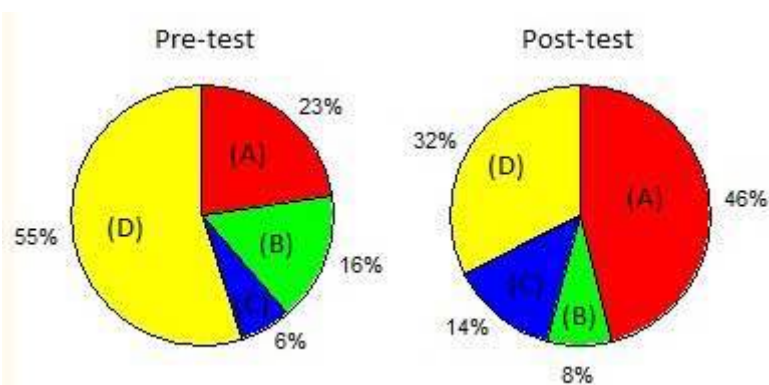

Figure 3. Pre-test and Post-test (Question 8 – answers of students)

To statistically evaluate collected data, we used paired Student's t-test, i.e. we considered only those students who took part both in the pre-test and post-test. After having paired the tests, there were 74 student samples left. The number indicates huge student fluctuation during semester as it corresponds only to 60% of students entering the course. It also betokens that many of those taking the course are not seriously interested in its successful completion. On the other hand, our experience show us that some students re-taking the course become more involved after the first third of semester.

The initial question was whether students would achieve increase in knowledge at the end of the semester and whether this increase would be statistically significant.

We stated the null hypothesis: H_0 : average test percentage at the beginning and at the end is the same so $H_0: \mu_1 = \mu_2$ (versus $H_1: \mu_1 \neq \mu_2$); while the difference in means $\mu_1 - \mu_2$ of two normal distributions, where $N(\mu_1, \sigma_1^2)$ and $N(\mu_2, \sigma_2^2)$, is considered equal 0 for both examined groups.

To verify the stated hypothesis, we used the test for a difference in arithmetic mean (two-sample paired t-test for the mean value for each group and two-sample t-test to compare control and experimental group); we tested at a significance level of $\alpha = 5\%$ and we suggested that the difference in arithmetic means $\mu_1 - \mu_2$ of two normal distributions $N(\mu_1, \sigma_1^2)$ and $N(\mu_2, \sigma_2^2)$ will fall into $100 \cdot (1 - \alpha) \%$ of two-sided confidence interval. At the beginning of testing we were detecting the concordance between the tested sample and the theoretical distribution, assuming the normal (Gaussian) distribution using the one-sample nonparametric Kolmogorov–Smirnov test (K–S test). The concordance proved the normality of the distribution (calculated data were lower than the critical values for K-S test of the normality at a significance level of $\alpha = 5\%$ specified by the program Statistica, where $D < D_{\max, n}$).

As shown in *Table 1*, the average student test percentage in the given test was around 32% at the end of the semester (post-test), while being 22% percentage at the beginning of the semester. Since calculated parameter $|t| > t_{critical(two-tail)}$ for the two-sided confidence interval, the hypothesis $H_0: \mu_1 = \mu_2$ was rejected and the alternative hypothesis $H_1: \mu_1 \neq \mu_2$ was accepted. Based on these, we stated new hypothesis: $H_0: \mu_1 < \mu_2$ (for $100 \cdot (1 - \alpha) \%$ right-sided confidence interval for the difference $\mu_2 - \mu_1$). Since $t \in (-\infty, t_{critical(one-tail)})$ the hypothesis $H_0: \mu_1 < \mu_2$ has been accepted. Statistical testing by means of paired Student's t-test has confirmed statistically significant difference in the knowledge at the end and at the beginning of the semester. The next phase of testing focused on the individual groups: the experimental and control ones; we have observed an increase in the knowledge of the individual groups (*Table 2* and *3*). We have also proved statistically significant difference in the knowledge at the end and at the beginning of the semester; initial level of knowledge was comparable for experimental and control groups.

The tables below, acquired by Excel spreadsheet, show the final statistical values:

Table 1. Paired t-test for the mean value

	Pre-test	Post-test
Mean	22.2972973	31.68918919
Variance	87.11588301	214.5733062
Observations	74	74
Pearson Correlation	0.309382046	
Hypothesized Mean Difference	0	
df	73	
t Stat	-5.483377465	
P(T<=t) one-tail	2.84794E-07	
t Critical one-tail	1.665996224	
P(T<=t) two-tail	5.69588E-07	
t Critical two-tail	1.992997126	

Table 2. Paired t-test for the mean value – experimental group

	Pre-test	Post-test
Mean	22.30769231	37.11538
Variance	110.4615385	212.3462
Observations	26	26
Pearson Correlation	0.175791126	
Hypothesized Mean Difference	0	
df	25	
t Stat	-4.603932688	
P(T<=t) one-tail	5.20105E-05	
t Critical one-tail	1.708140761	
P(T<=t) two-tail	0.000104021	
t Critical two-tail	2.059538553	

Table 3. Paired t-test for the mean value – control group

	Pre-test	Post-test
Mean	22.29166667	28.75
Variance	76.55141844	195.212766
Observations	48	48
Pearson Correlation	0.419893098	
Hypothesized Mean Difference	0	
df	47	
t Stat	-3.440831074	
P(T<=t) one-tail	0.000613406	
t Critical one-tail	1.677926722	
P(T<=t) two-tail	0.001226813	
t Critical two-tail	2.011740514	

Correctness of the decision on the acceptance of the alternative hypothesis of inequality of mean values is also proved by the p-value ($P(T \leq t)$) which is significantly lower than the opted significance level of $\alpha = 0.05$. We focused our attention also on the statistically significant difference in the knowledge of the experimental and the control group at the end of the semester. Before we started testing of the null hypothesis $H_0: \mu_1 = \mu_2$, it was necessary to apply the F-test (Fisher-Snedecor test) for the equality of two normally distributed populations ($H_0: \sigma_1^2 = \sigma_2^2$ versus $H_1: \sigma_1^2 \neq \sigma_2^2$). After specifying the equality (or inequality) of the variances, to test the hypothesis $H_0: \mu_1 = \mu_2$ we used two-sample Student's t-test for the unequal sample sizes but with equal (eventually unequal) variance.

Since calculated parameter F verifies the condition $F_{critical1-\alpha/2} < F < F_{critical\alpha/2}$ (for two-sided interval F in the range of 0.479 - 1.938), the assumed hypothesis of the equality of variances for the experimental and the control group at the beginning of the semester $H_0: \sigma_1^2 = \sigma_2^2$ has been accepted.

Table 4. Two-sample F-test for variances: pre-test

	Experimental group	Control group
Mean	22.30769231	22.29166667
Variance	110.4615385	76.55141844
Observations	26	48
df	25	47
F	1.442971805	
P(F<=f) one-tail	0.13726926	
F Critical one-tail	1.741623444	

Thereafter, we used two-sample Student's t-test for the unequal sample sizes but with equal variance to test the hypothesis $H_0: \mu_1 = \mu_2$. It has confirmed the hypothesis on the equality of the entry knowledge level of both the experimental and the control group ($|t| < t_{critical(two-tail)}$) (Tab. 5, Fig. 4).

Table 5. Two-sample F-test for variances: pre-test

	Experimental group	Control group
Mean	22.30769231	22.29166667
Variance	110.4615385	76.55141844
Observations	26	48
Pearson Correlation	88.32576567	
df	72	
t Stat	0.007002662	
P(T<=t) one-tail	0.497216048	
t Critical one-tail	1.666293696	
P(T<=t) two-tail	0.994432097	
t Critical two-tail	1.993463567	

Similar analysis as above was done at the end of the semester. F-test has confirmed the equality of two normally distributed populations at the end of the semester. (Tab. 6) ($H_0: \sigma_1^2 = \sigma_2^2$).

Table 6. Two-sample F-test for variances: post-test

	Experimental group	Control group
Mean	37.11538462	28.75
Variance	212.3461538	195.212766
Observations	26	48
df	25	47
F	1.087767764	
P(F<=f) one-tail	0.391514187	
F Critical one-tail	1.741623444	

Next we used two-sample Student's t-test for the unequal sample sizes but with equal variance to test the hypothesis $H_0: \mu_1 = \mu_2$. Based on the results we reject the null hypothesis on the equality of entry knowledge level at each significance level higher than 1,8 %. Therefore we rejected the hypothesis $H_0: \mu_1 = \mu_2$ and stated the alternative hypothesis $H_0: \mu_1 \neq \mu_2$ for $100 \cdot (1-\alpha)$ % left-sided confidence interval for the difference $\mu_2 - \mu_1$. Since $t \in (t_{critical(one-tail)}, \infty)$, the hypothesis $H_0: \mu_1 > \mu_2$ has been accepted. Statistical testing by means of Student's t-test has confirmed statistically significant difference in the knowledge of the experimental and the control group at the end of tuition. (Tab. 7, Fig. 5).

Table 7. Two-sample t-test assuming equal variances: post-test

	Experimental group	Control group
Mean	37.11538462	28.75
Variance	212.3461538	195.212766
Observations	26	48
Pearson Correlation	201.161859	
Hypothesized Mean Difference	0	
df	72	
t Stat	2.422169471	
P(T<=t) one-tail	0.008973382	
t Critical one-tail	1.666293696	
P(T<=t) two-tail	0.017946765	
t Critical two-tail	1.993463567	

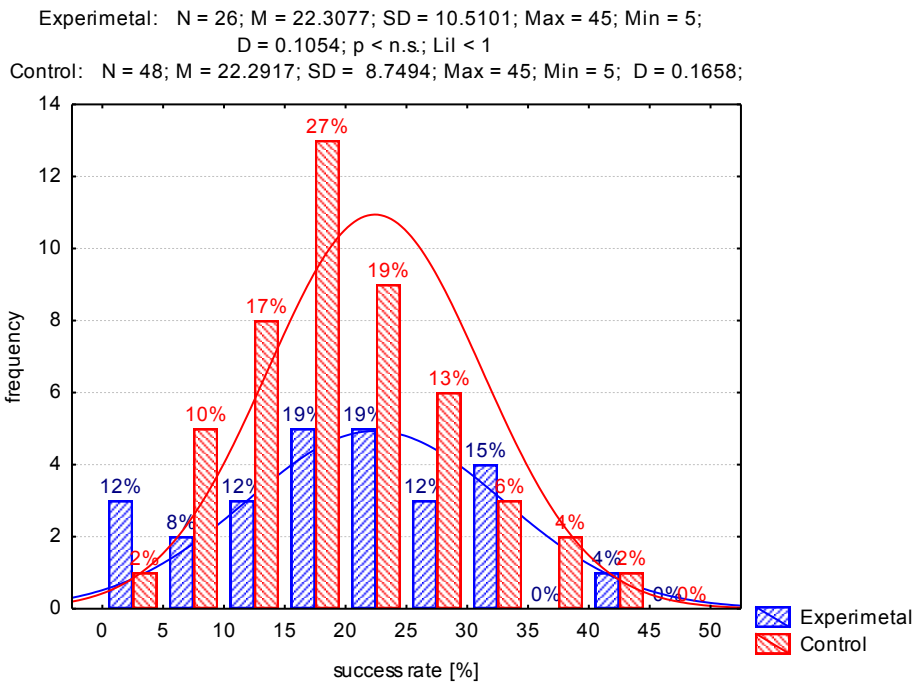

Figure 4. Results analysis of the experimental and the control group: pre-test

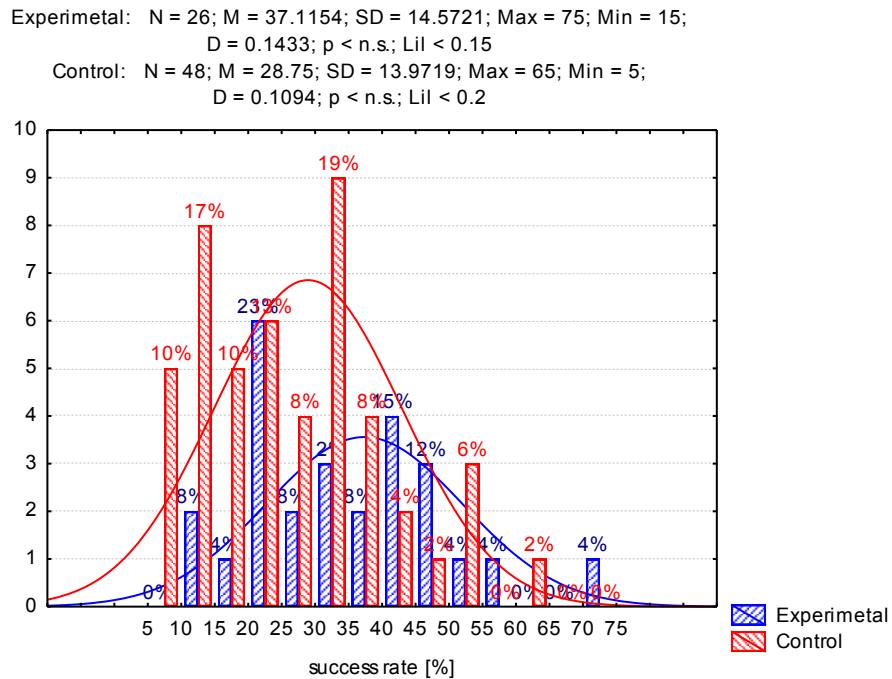

Figure 5. Results analysis of the experimental and the control group: post-test

3. Conclusion

Testing we realised has shown the following:

- There has been an increase in the knowledge both in the experimental and in the control group.

- Increase in the knowledge in the experimental group, the one solving equations by means of video analysis, was higher than in the control group.
- The difference in the knowledge level between the experimental and control group was statistically significant, at the significance level of $\alpha = 5\%$.
- In the future we would like to confirm these results with the higher number of responders in both experimental and control group.

Acknowledgement

This work was supported by the Slovak Grant Agency KEGA through the project No. 035ŽU-4/2012 and and project Erasmus+: Strategic Partnership: Early identification of STEM readiness and targeted academic interventions (readySTEMgo): grant Decision number: 2014-BE02-KA200-000462.

References

Hockicko, P. (2013). Fyzika v príkladoch a videopríkladoch / Video-analysis based tasks in physics. 1.ed. Žilina: Edis, [DVD]. on-line: http://hockicko.uniza.sk/Priklady/video_tasks.htm

Hockicko, P., Krišťák, L., Němec, M. (2015). Development of Students' Conceptual Thinking by Means of Video Analysis and Interactive Simulations at Technical Universities. *European Journal of Engineering Education*, Vol. 40, Iss 2. pp. 145 – 166. ISSN 0304-3797 (Print), 1469-5898 (Online) DOI:10.1080/03043797.2014.941337

Hockicko, P., Rochovská, I. (2013). Detection, analysis and the possibilities on eliminating misunderstandings and misconceptions in the physics education at technical universities. In Kireš, M., Krupa, D. (Ed.), *Proceedings of the conference Creative teacher of physics VI, National festival of physics 2013. 1st ed. Bratislava: Slovak Physical Society*, pp. 126 - 132, ISBN 978-80-971450-0-2.

Hockicko, P., Trpišová, B., Ondruš, J. (2014). Correcting Students' Misconceptions about Automobile Braking Distances and Video Analysis Using Interactive Program Tracker. *Journal of Science Education and Technology*, December 2014, Vol. 23, Iss. 6, pp. 763-776, ISSN 1573-1839. DOI: 10.1007/s10956-014-9510-z

Monitor tests: ŠPU (National Institute for Education of the Slovak Republic)

program STATISTICA (trial version), StatSoft, Inc. 2011. <http://www.statsoft.com>

Suhonen, S., Tiili, J. (2014). Active Engaging Video Assisted Physics Studies - Preliminary Results. In *Proceedings of World Conference on Educational Multimedia, Hypermedia and Telecommunications 2014*, 1636-1644. Chesapeake, VA: AACE.

To see the pre and post test questions, visit: <http://hockicko.uniza.sk/pre-post-test.pdf>

Affiliation and address information

Peter Hockicko
 Department of Physics
 Faculty of Electrical Engineering
 University of Žilina
 Univerzitná 1
 01026 Žilina
 Slovakia
 e-mail: hockicko@fyzika.uniza.sk

Katarína Pažická
 Institute of Foreign Languages
 University of Žilina
 Univerzitná 1
 01026 Žilina
 Slovakia
 e-mail: katarina.pazicka@ucj.uniza.sk

Improving Students' Understanding by Using On-Going Education Research to Refine Active Learning Activities in a First-Year Electronics Course

Alexander Peter Mazzolini, Scott Arthur Daniel

*Science, Technology, Engineering and Mathematics Education Group (STEMed)
Swinburne University of Technology
PO Box 218, Hawthorn, Melbourne, Australia, 3122*

Abstract

Interactive Lecture Demonstrations (ILDs) have been used across introductory university physics as a successful active learning (AL) strategy to improve students' conceptual understanding. We have developed ILDs for more complex topics in our first-year electronics course. In 2006 we began developing ILDs to improve students' conceptual understanding of Operational Amplifiers (OAs) and negative feedback in amplification circuits. The ILDs were used after traditional lecture instruction to help students consolidate their understanding. We developed a diagnostic test, to be administered to students both before and after the ILDs, as a measure of how effective the ILDs were in improving students' understanding. We argue that an on-going critical analysis of student performance (using education research principles) is essential for improving education practice. Our analysis of student surveys, pre- and post-tests, ILD activities and final examinations, have yielded valuable feedback on how well we have designed and delivered our OA ILD interventions. During the period 2006-2013, we have found that:

- (a) many hours of traditional lectures do little to improve students' conceptual understanding.
- (b) a few additional hours of ILDs significantly improves students' conceptual understanding.
- (c) few students attend lectures consistently (either traditional or ILDs).
- (d) students find the concepts relating to OAs difficult, but students achieved much better scores on the OA examination question after the introduction of ILDs.
- (e) students recognise the learning benefits of the ILDs.

Our on-going education research has driven improvements in our active learning strategy, including:

- (1) recognising the importance of the facilitator role in active learning.
- (2) using a lesson plan that is consistent with an active learning pedagogy.
- (3) reviewing assessment tools and learning activities so that they improve student learning.
- (4) redesigning ILD equipment and activities to make them simpler and clearer to understand.
- (5) reviewing lesson plans to make them focused on simple key concepts.

The implications of using on-going education research results to refine the effectiveness of our L&T approach are clear. If we had implemented our initial ILD approach back in 2006 and continued on without the critical review that came from our own education research, we may have assumed that what we were doing was an effective AL approach. Instead, our education research results are an on-going trigger for review of, and self-reflection on, our teaching practices. Our education research gives us a quantitative measure of the success (or otherwise) of the interventions that we try in our teaching.

Keywords

Education research informing practice, Electronics, Interactive lecture demonstrations

1. Background for active learning in electronics at Swinburne University

Over the past eight years, we have tried to implement a partial active learning (AL) strategy for our introductory electronics course at Swinburne University of Technology. This course is taken by a large number of STEM students (from 100 to 300 each semester), although a considerably smaller number consistently participate in our AL activities, assessment tests and surveys. Over that time, we have

redesigned our traditional problem-solving tutorial sessions to make them more interactive and collaborative, and to cover both numeric and conceptual problems. We have also redesigned our traditional recipe-style laboratory sessions to be more collaborative, by encouraging students to discuss their predictions before constructing circuits and making any measurements.

While we have continued to utilise traditional lectures for transmissive teaching, we have introduced some Interactive Lecture Demonstrations (ILDs) to supplement the traditional lectures in two key areas of electronics where we know students have significant difficulties with their conceptual understanding: (i) operational amplifiers and negative feedback, and (ii) AC circuits and resonance.

2. Interactive Lecture Demonstrations

Students hold conceptions about physical phenomena that they have developed through their experience of the world (Redish, 1994). If at odds with accepted scientific explanations, they are called misconceptions and can be very resistant to being changed by traditional teaching methods (Muller, 2008). The use of ILDs is one strategy that has been developed to directly challenge students' misconceptions (Sokoloff & Thornton, 2004). Each ILD activity follows a similar sequence:

1. Students are presented with some experimental set-up and asked to record a prediction about the outcome of some experimental manipulation.
2. Students discuss their predictions with their peers, and are given an opportunity to reassess and perhaps change their predictions.
3. Students observe the outcome of the experimental manipulation.
4. The lecturer facilitates a discussion to reconcile students' predictions with their observations, and help incorporate the observations into their conceptual frameworks.

ILDs have been found to be more effective than traditional instruction in improving student conceptual understanding (Sharma et al., 2010).

3. ILDs at Swinburne

At Swinburne, we have developed and evaluated ILDs for the topics '*Operational Amplifiers (OAs) with and without negative feedback*' (Mazzolini & Daniel, 2014; Mazzolini, Edwards, Rachinger, Nopparatjamjomras, & Shepherd, 2011) and '*AC circuits and resonance*' (Daniel & Mazzolini, 2014; Daniel, Mazzolini, Cadusch, & Edwards, 2012; Mazzolini, Daniel, & Edwards, 2012). This paper discusses the evolution of our teaching practices, which has been guided by our physics education research (PER), and the effectiveness of our OA ILDs in improving students' conceptual understanding of amplification and feedback. (We have also discussed some of our AC circuits and resonance ILD results whenever they have added some insight into the interconnection of our PER and teaching practices). We use a 'blended learning' approach to the teaching of the OA section of the course: students undertake 8 hours of traditional lectures followed by 2-3 hours of ILD activities in a large lecture hall. For logistical reasons, the OA ILDs occur near the end of semester as part of the revision of difficult topics. Recently, we have started to use clickers (audience polling devices) to reduce the amount of student transcription and in-class administration, and also to improve the efficiency of data collection and analysis. The students that take our electronics course are non-electronics majors.

What has education research revealed about student learning in our introductory electronics course

Delivering ILD instruction in our electronics course at Swinburne University for nearly a decade has taught us many things about learning and teaching. In particular, the ability to collect and analyse PER data over that time period has given us many insights into how our students learn; many of these insights have been counter-intuitive to us as teachers.

Many hours of traditional lectures do little to improve students' conceptual understanding

In our electronics course, we have routinely assessed students' levels of understanding of various topics. One of the diagnostic tools that we have used is *identical pre- and post-tests* consisting of multiple-choice questions that have been designed to probe students' understanding of specific key concepts. Typically, the average normalised gain $\langle g \rangle$ has been used to measure improvements from a pre-test to post-test (Hake, 1998). It is defined as:

$$g = \frac{\text{Observed improvement}}{\text{Maximum possible improvement}}$$

In the studies reported here, the pre-tests were administered to students after traditional instruction but before ILD instruction, and then the post-tests were administered after ILD instruction. Interestingly, students' pre-test scores (i.e. after about 8 hours of traditional instruction in Operational Amplifiers) were typically around 25%, which given that these multiple-choice questions usually have only 5 or 6 alternatives is not much better than chance.

In 2011, while assessing students' understanding of AC circuits, we selected three questions from the relevant diagnostic test and collected student responses *before* traditional instruction to establish a baseline of student understanding. These questions assessed how well students could interpret the phase relationship between two sinusoidal waveforms. This is a critical concept for AC circuit analysis that students would have had some limited exposure to at high school and in their introductory mathematics and physics courses at university. As can be seen in table 1, there was *no* significant difference in students' average test score between this baseline test (before traditional instruction) and the pre-test (after 8 hours of traditional instruction). On the other hand, there was a significant improvement ($\langle g \rangle = 0.55$) in students' performance on these particular questions between the pre-test (after the 8 hours of traditional instruction) and the post-test (after an additional 2 hours of ILD instruction).

Table 1. Student test performance on phase relationships between sinusoids.

Diagnostic Test	Percentage correct	No. of participating students
Baseline test	66.7	81
Pre-test	65.4	52
Post-test	84.6	33

A few additional hours of ILDs significantly improves students' conceptual understanding

In the last section, 2 hours of ILD instruction in interpreting AC waveforms and their vector (phasor) representation significantly improved ($\langle g \rangle = 0.55$) students' understanding of the phase relationship between sinusoidal waveforms.

We have also observed significant improvement after our OA ILDs. For example in 2013, the 13 students that attended all OA ILD instruction showed an average normalised gain of $\langle g \rangle = 0.21$ when comparing their OA pre-test scores (after 8 hours of traditional instruction) and post-test scores (after an additional 2 hours of ILD instruction), as shown in table 2. This gain is more significant than it first appears because it represents the improvement *after traditional instruction from only 2 hours of additional ILD active learning instruction* covering the same material.

Table 2. Diagnostic test results for a pre- and post-test (7 multiple-choice questions on OA concepts). These results show the number of students who correctly answered each question (as a percentage), the average of the 7 questions, and the corresponding normalised gains between pre- and post-tests.

Only data from the 13 students who participated in all OA ILD activities have been included.

Diagnostic Test	Q1	Q2	Q3	Q4	Q5	Q6	Q7	Average
Pre-test (Score after traditional lectures)	15.4%	23.1%	38.5%	53.9%	0.0%	7.7%	46.2%	26.4%
Post-test (Score after ILDs)	30.8%	7.7%	61.5%	61.5%	7.7%	61.5%	61.5%	41.8%
Normalised gain $\langle g \rangle$	0.18	-0.20	0.38	0.17	0.08	0.58	0.29	0.21

However, this simple measure of learning gains masks a large degree of learning complexity. As can be seen in table 2, there is a large variation in how many students correctly answered each question in the pre- and post-test. More than this, there is also a large variation in the gains for each question: there was a substantial improvement on question 6, whereas on question 2 students actually did worse on the post-test. Such variations in a set of questions designed to assess understanding of OA concepts that are closely linked (at least in the teacher's mind) indicate that the path from confusion to clarity is indirect for many students.

The path from confusion to clarity does not appear to be straightforward for many students. Our results suggest that it is *not* like a switch that turns 'understanding' on (i.e. like an incandescent light bulb that is off and then switches on). Instead we suspect that students gain partial understanding of concepts within certain contexts, and that deep conceptual understanding only develops after much trial and error (a little like the way a fluorescent light flickers several times before finally switching on) (Orlin, 2013). This idea is demonstrated by the following example.

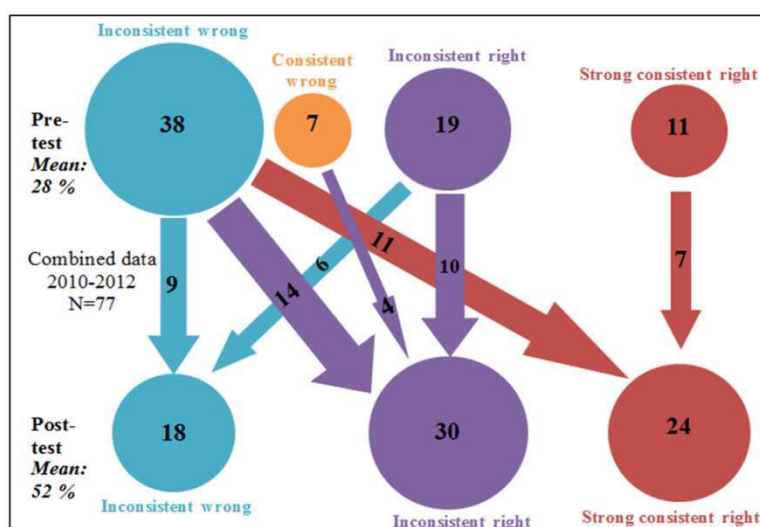

Figure 1. Changes in consistency from pre-test to post-test (transitions of less than four people excluded)

In our 'AC circuits and resonance' diagnostic test, there were two questions that to the expert represented different manifestations of the same underlying phenomenon, so-called *expert-equivalent* questions (Bao & Redish, 2006). These two questions investigated students' understanding of the same concept in resonance via (i) a word description question and (ii) a visual description question. A superficial analysis of the pre- and post-test results for these two questions from the combined data from 2010 to 2012 indicated that the average score went from 28% (pre-test, after traditional instruction) to 52% (post-test, after additional ILDs), which showed a respectable normalised gain of $\langle g \rangle = 0.33$. However, we went further than this: not only checking whether students answered the questions correctly or not, but also evaluating whether their two answers were conceptually consistent with each other, and tracking how their responses changed from the pre-test to the post-test (Daniel & Mazzolini, 2014). Although there was a general shift towards answering more questions correctly in the post-test (shown in figure 1 by the trend to the right), the map of transitions is clearly complex. Most students answered inconsistently and, in particular, the largest category in the post-test was 'inconsistent right' – that is, they answered only one of the questions correctly. They seem to have understood the phenomenon in one context, but not transferred their understanding to the other context. This may be an example of the 'specificity effect' (Brookes, Ross, & Mestre, 2011) where students have not yet generalised their understanding of a principle beyond the example used to present it.

Few students attend lectures consistently (either traditional or ILDs)

When we run our traditional lectures or ILDs at Swinburne University, we see about 35-40% of the enrolled cohort attending any particular class. Previously we had assumed that these students were the conscientious ones that attended *all* classes. (Consistent attendance is important in STEM disciplines where the concepts developed in one class build on those developed in the previous class.) But the analysis of our ILD data revealed that (i) in 2012, of the possible 154 students who attempted the exam, only 26 attended all 3 consecutive ILD sessions, and (ii) in 2013, of the possible 135 students who attempted the exam, only 31 attended 3 or all 4 ILD sessions. Clearly our students did not consistently attend ILD classes in a sequential

manner in 2012-13, even though they appeared to be interacting well and enjoying the classes. We wondered if one reason for the poor consecutive attendance at our ILD classes was that the ILDs came near the end of semester and perhaps many students had become disillusioned or ‘burnt out’ by then, or that they were under severe time pressure to meet end of semester deadlines for assignments etc. However, when we examined attendance in several other courses at our university, we found that attendance was sporadic for several traditional lecture classes and not just for our ILD classes. The attendance data was a good approximate fit to a binomial distribution, which meant that it was almost as if each student flipped a slightly weighted coin in deciding whether or not to attend any particular lecture or ILD (Daniel, Mazzolini, & Schier, 2012). This is not a good sign for sequential STEM teaching!

Although students find the concepts relating to Operational Amplifiers difficult, their exam marks on related questions improve significantly after OA ILDs

In 2011 we did not run any OA ILDs as in that year we concentrated on running new ILDs relating to AC circuits and resonance. With only traditional lectures on OAs that year, students performed comparatively poorly on the OA question, with an average score of 27% compared to the average score on all other exam questions of 55%. However, when we ran OA ILDs in 2012 and 2013, the exam performance on the OA question was much improved. The average exam score for the OA question (averaged over those two years) was 58%, comparable to the average exam score of 64% for all other topics. The OA questions each year were very similar in format, and designed to test concepts rather than students’ ability to apply formulas.

However, this improved performance on the OA exam question in 2012 and 2013, when the ILD activities were held, at the time was surprising because students had performed so poorly on the ILD post-tests. For students that attended all the ILD sessions, the average score on the post-test in 2012 was only 29% ($\langle g \rangle = 0.05$) and in 2013 not much better at 42% ($\langle g \rangle = 0.21$). During the ILD activities, we felt that students were having considerable difficulties in understanding the concepts associated with OAs and negative feedback. It is clear that the ILDs did partially improve conceptual understanding, and we further speculate that the ILDs also gave students clear and unequivocal feedback on their level of understanding (much more than traditional lectures) and that this may have help drive good study practices for OAs prior to the examinations.

Students appear to recognize the learning benefits of the ILDs

We have tried to gauge students’ perceptions of the OA ILD sessions via questionnaires. In 2012, we ran an in-class survey (60 students participated) and in 2013, we ran a post-semester on-line survey (13 students participated). The results are shown in table 3. As can be seen, the majority of students in both years had positive (*agree* and *strongly agree*) responses to the statements regarding the effectiveness, helpfulness and interest level of ILDs compared to traditional lectures. This is encouraging as we ask a lot of our students during the ILD sessions, and the level of interaction we expect is perhaps outside the comfort zone of some of our students who think that education is primarily about the transmission of information. The following comment about the OA ILDs, written by a student who participated in the 2013 on-line survey clearly articulates the reason why our on-going education research to refine and improve our ILD activities is so important.

“The Op-Amp lectures were by far the most useful lectures of the semester. If this method of lecture delivery was adapted to the rest of the course topics... ..it [would] represent a huge step forward for both the delivery of the course and the intelligibility of the subject material.”

Table 3. Summarised questionnaire responses about OA ILDs (2012-2013)

Statement	Yea r	SD	D	N	A	SA
ILDs are more <i>interesting</i> than normal lectures	201 2	5.2%	5.2%	22.4 %	51.7 %	15.5 %
ILDs clearly show me the <i>gaps</i> in my knowledge	201 2	1.6%	0%	8.1%	54.8 %	35.5 %
ILD classes gave me good <i>feedback</i> on how well I understood OAs	201 3	0%	0%	23.1 %	23.1 %	53.8 %
<i>I learn</i> more from an ILD than I do	201	3.5%	7.0%	42.1	36.9	10.5

from a normal lecture	2			%	%	%
ILDs were more effective than normal lectures in helping me <i>learn</i> about OAs	201	0%	0%	41.7	8.3%	50%
	3			%		
ILDs helped me <i>understand</i> OAs	201	0%	0%	30.8	23.1	46.1
	3			%	%	%

How has collecting, and reflecting on, PER data improved our students' learning

Progress in science is often based on interpreting observational data. Should we not use the same criteria for guiding our progress in science education? The following are some examples of how reflecting on our PER has helped us improve the learning outcomes of our students.

Importance of the 'facilitator role' in active learning

To be effective, an active learning class needs a very well-trained facilitator, but unfortunately the role of facilitator does not come naturally to some academics. From a personal perspective, one of us (APM) recalled that in his early active learning classes he felt that he was an excellent AL facilitator. But one year, one of his colleagues videoed some of his ILD classes and it quickly became apparent that he was doing far too much lecturing and not enough facilitating. This has been a personal lesson that is still hard for him to learn today! Fortunately our electronics ILD classes are now taught by the two of us, and we constantly review and debrief with each other how well we are facilitating the active learning in our classes. We now believe, more than ever, that peer discussion, rather than direct instruction, is the key to student learning (Smith, Wood, Krauter, & Knight, 2011).

Lesson plans should use a learning cycle that is consistent with active learning pedagogy

We use a well-defined PODS (Predict Observe Discuss Synthesise) learning cycle with each ILD activity. This learning cycle is based on a well-established active learning pedagogy (Mazur, 1997). In recent years, using 'clickers' in our ILD classes has enabled us to easily monitor *in real time* our students' predictions in regard to the outcomes of various ILD experiments. Our PER data has indicated that peer discussion in-between students' initial prediction and their revised prediction is extremely important in the learning process. Figure 2 shows the prediction and revised prediction data from a typical ILD session. In this example, only 29% of the class initially predicted the correct outcome for the ILD experiment, with 71% of the students choosing one of the 7 distractors. The students were then asked to try to convince a student nearby who had a different prediction to change their opinion. After only one or two minutes of discussion, 81% of the students had revised their predictions correctly.

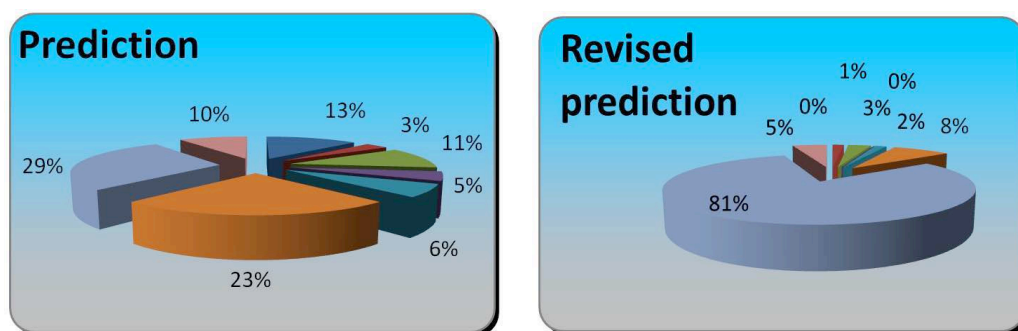

Figure 2. Initial prediction (29% of students predicted correctly) and revised prediction after peer discussions (81% of students predicted correctly) from a typical OA ILD session

Assessment tools and learning activities should be reviewed frequently

Before we started using ILDs, we adopted the convention used commonly in electronic textbooks and referred to the voltage gain of an isolated OA as its *open-loop gain*, and to the gain of an OA circuit using negative feedback as its *closed-loop gain*. Once OA ILDs had commenced, it became apparent during the ILD activities and during the analysis of pre- and post-test data that there was considerable confusion about the concepts of open-loop gain and closed-loop gain. It appeared to us that some students were confusing a property of the OA (open-loop gain) with a property of the OA circuit (closed-loop gain). To help rectify this

confusion we now use the terms *intrinsic gain* instead of open-loop gain, and *circuit feedback gain* instead of closed-loop gain. We have noticed that this simple name change has reduced students' confusion in OA pre- and post-test questions related to these concepts.

ILD equipment and activities should be reviewed and redesigned to make them simpler and clearer to understand

When we first started OA ILD instruction in 2006, we designed and built a very detailed and flexible OA board (see figure 3a), which allowed us to construct a vast array of different OA circuits. The OA circuits were constructed at the front of the class, and a video image of the board was projected onto a large screen. Students could then look at the board while making predictions and observations from an *ILD activities* PowerPoint presentation displayed on a second screen. We used the OA board for many years, but some students told us that the board was too complicated (even when we covered up some of the functionality as shown in the figure) and that it often did not exactly match the circuits we were discussing in the PowerPoint presentations. Although it took much effort, the board was eventually redesigned (so that it more closely resembled the diagrams in the ILD activities) and simplified (see figure 3b). The new board was used for the first time in the 2013. The average normalised gain in 2012 for the students that attended all the OA ILD sessions was only 0.05, whereas in 2013 the gain was 0.21. We attribute these improved learning gains in part to the better-designed OA circuit board.

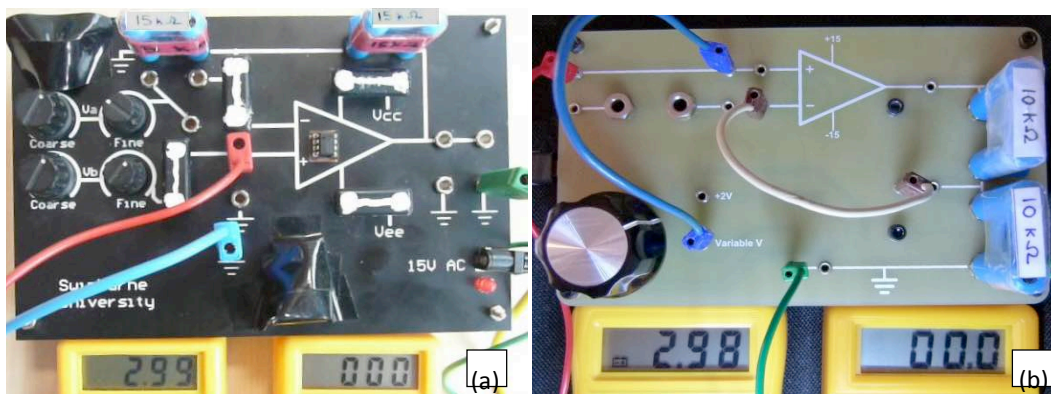

Figure 3. (a) Initial OA ILD equipment (2006-12) (b) Revised OA ILD equipment (2013)

ILD lesson plans should be reviewed to make them focused on simple key concepts

When we reviewed our OA ILD data each year, it became apparent to us that students were having considerable and on-going difficulties in understanding the key concepts about OAs and negative feedback. In 2013, we undertook a major review of our ILD lesson plans and rewrote them so that they focused only on key concepts that students were having difficulties with. With these revised ILDs, performance on the post-test increased from 29% in 2012 to 42% in 2013. That such poor statistics nevertheless represent some improvement in teaching and learning is an indication of how difficult these concepts are for students.

4. Conclusion

Successful teaching requires humility: an acceptance of the difficulty of achieving a deep understanding of the concepts in question, and our limited ability to successfully challenge and overcome our students' strongly-held misconceptions. An on-going critical and rigorous evaluation of our own teaching practices and whether those practices do or do not positively influence student learning, is the key prerequisite for any improvements.

“Let the long and the short of our didactic be to investigate and discover the means for teachers to teach less, and learners to learn more.”

John Amos Comenius, *Didactica Magna* (1628)

References

Bao, L., & Redish, E. (2006). Model analysis: Representing and assessing the dynamics of student learning. *Physical Review Special Topics - Physics Education Research*, **2**(1), 010103.1-16.

- Brookes, D. T., Ross, B. H., & Mestre, J. P. (2011). Specificity, transfer, and the development of expertise. *Physical Review Special Topics - Physics Education Research*, **7(1)**, 010105.1-8.
- Daniel, S., & Mazzolini, A. (2014). The messy transition from wrong to right: improvements, but persistent inconsistencies on conceptually-equivalent questions after Interactive Lecture Demonstrations. *Proceedings of the International Conference on Physics Education*. Charles University in Prague, Prague, Czech Republic, MATFYZPRESS: 341-353.
- Daniel, S., Mazzolini, A., Cadusch, P. J., & Edwards, T. (2012). Addressing student misconceptions of phasors and AC resonance. *20th Australian Institute of Physics Congress*, Sydney, Australia. http://www.aip.org.au/info/sites/default/files/Congress2012/22._DANIEL_AIP2012.pdf
- Daniel, S., Mazzolini, A., & Schier, M. (2012). Is lecture attendance just a flip of a coin? *Proceedings of the Australasian Association for Engineering Education Conference*, Swinburne University, Melbourne, Australia. 573-82
- Hake, R. R. (1998). Interactive-engagement versus traditional methods: A six-thousand-student survey of mechanics test data for introductory physics courses. *American Journal of Physics*, **66(1)**, 64-74.
- Mazur, E. (1997). *Peer instruction : a user's manual*. Upper Saddle River, N.J.: Prentice Hall.
- Mazzolini, A., & Daniel, S. (2014). The use of active learning methods in introductory electronics deliver positive learning outcomes, yet some academics still resist change. *Physical Society of Japan Conference Proceedings*, **1**, 017006.1-7.
- Mazzolini, A., Daniel, S., & Edwards, T. (2012). Using Interactive Lecture Demonstrations to Improve Conceptual Understanding of Resonance in an Electronics Course. *Australasian Journal of Engineering Education*, **18(1)**, 69-88.
- Mazzolini, A., Edwards, T., Rachinger, W., Nopparatjamjomras, S., & Shepherd, O. (2011). The use of interactive lecture demonstrations to improve students' understanding of operational amplifiers in a tertiary introductory electronics course. *Latin-American Journal of Physics Education*, **5(1)**, 147-153.
- Muller, D. A. (2008). *Designing Effective Multimedia for Physics Education*. (Doctor of Philosophy), University of Sydney, Sydney.
- Orlin, B. (2013). Learning is a Fluorescent Light. From 'Maths with Bad Drawings' web site-<http://mathwithbaddrawings.com/2013/07/11/learning-is-a-flourescent-light/>
- Redish, E. F. (1994). Implications of cognitive studies for teaching physics. *American Journal of Physics*, **62(9)**, 796-803.
- Sharma, M., Johnston, I., Johnston, H., Varvell, K., Robertson, G., Hopkins, A., . . . Thornton, R. (2010). Use of interactive lecture demonstrations: A ten year study. *Physical Review Special Topics - Physics Education Research*, **6(2)**, 020119.1-9.
- Smith, M. K., Wood, W. B., Krauter, K., & Knight, J. K. (2011). Combining peer discussion with instructor explanation increases student learning from in-class concept questions. *CBE Life Sci Educ*, **10(1)**, 55-63.
- Sokoloff, D. R., & Thornton, R. K. (2004). *Interactive lecture demonstrations : active learning in introductory physics*. Hoboken, N.J.: Hoboken, N.J. : John Wiley.

Affiliation and address information

Alex Mazzolini
 Science, Technology, Engineering and Mathematics Education Group (STEMed)
 Faculty of Science, Engineering and Technology,
 Swinburne University of Technology
 John Street, Hawthorn, Melbourne,
 Victoria, Australia. 3103
 e-mail: amazzolini@swin.edu.au

Teaching electrostatics through Project-Based Learning

Carlos Collazos^{1,2,3}, César Mora¹, Ricardo Otero², Jaime Isaza²

¹Center of Research in Applied Science and Advanced Technology of National Polytechnic Institute, Av. Legaria 694, Col. Irrigación, C. P. 11500, México D. F.

² Faculty of Natural Sciences, Colombian School of Engineering, Ak. 45 No. 205-59, Autopista Norte, Bogotá D. C., Colombia.

³Physical Laboratory, Manuela Beltrán University, Avenida Circunvalar No. 60-00, Bogotá D. C., Colombia.

Abstract

In the classroom programs of electricity and magnetism at the college level, the electrostatics subjects are considered in traditional curriculum. However so frequently, we can see that in the instruction and curriculum the students are focused only to accumulate and verify concepts. In this work we show a strategy that involves final scientific projects or so-called practical work where the understanding of physical phenomena is developed through experimentation. For this research we rely on authors suggest the possibility of working in classroom activities that bring students to the scientific work. Our instructional strategy based projects is originated in the constructivist approach that emerged through the work of psychologists and educators as Lev Vygotsky, Jerome Bruner, Jean Piaget and John Dewey. Active learning for its part according to Sokoloff states that the teaching of physics can be undertaken using Interactive Lectures Demonstration. This research has been focused on developing three projects, namely: electrostatics, Torsion Balance Coulomb, Van de Graff generator. One part of the project was developed in the first semester of 2014 with engineering students. We present our Analysis result obtained using psychometric tools such as Hake gain. In addition, the strengths and difficulties of the strategy employed compared to traditional instruction are presented.

Keywords

Project-based learning, prototypes, electrostatic.

1. Introduction

The programs in science and engineering uses the physics in their curriculum. However, the current curriculum requires not only the accumulation and verification of concepts but of skills to train students for analysis, problem solving, and to use information appropriately according to (Kelly, 1999). Among the strategies to use are the research activities and final projects, so-called practical work. Our aim is to show, - following to Gil-, the importance of the physical processes through experimentation. For instance the possibility of working on activities that involve the scientific work and in the same way the application of the "scientific method" (Gil, 1988).

This research presents the results obtained in the design and construction of prototypes for electrostatics (P1); Torsion Balance Coulomb (P2), Van de Graff generator (P3) in electricity and magnetism. *Figure 1* shows prototypes which were developed by students. Based on our experience in 2014 with student's projects belonging to Faculties of Engineering in the Manuela Beltrán University (MBU) and Colombian School of engineering (CSE) in Bogotá, Colombia. The paper is structured as follows: In section II we review the project-based learning. Section III we present the prototyping strategy in Electrostatics. Section IV we show the methodology used. Section V we present the results. Section VI we present the conclusions of the strategy employed.



Figure 1: Prototypes developed for students in Electrostatics.

2. Project based learning in physics

This type of educational practices and project based learning activities can generate more flexible with the student's needs according to (Ausebel, 1986; Hernández, 2004; Piaget, 1969).

2.1. Elements

The basic elements according to (Blank, 1997; Thomas, 2008) are:

- a) Focus on the student.
- b) Meaningful content for students, directly observable in their environment.

2.2. Benefits

The most important benefits of project-based learning as (Blank, 1997; Thomas, 2008) are:

- a) To increase social and communication skills.
- b) To allow students to use their individual and collective strengths through collaborative work.

2.3. Structure

We present a basic structure according to (Blank, 1997; Thomas, 2008) are:

- a) Situation or problem.
- b) Description and purpose of the project.
- c) Specifications and standards to achieve progressively.

2.4. Learning Goals

We have identified two questions that must be taken into account according to (Blank, 1997; Thomas, 2008) are:

- a) What kind of problems do we want to be able to solve in the students?
- b) What concepts and principles do we want for the students to be able to apply?

3. Construction of prototypes in electrostatics

3.1. What is it?

It is a strategy based on the design and construction of prototypes that allows uses the scientific method on the development of projects. Besides the students can also activate other level skills of graphic expression, oral and written.

3.2. Learning Goals

- a) To introduce students in the process of design and construction of prototypes.
- b) To engage students with the concepts of physical modeling, error theory and graphical analysis.

3.3. Cycle of experimentation with prototypes

The fundamental structure of experimentation with the prototypes is indicated in (Collazos, 2009). The methodology was used at the level of rotational dynamics as shown (Collazos, 2009a; Collazos, 2009c; Collazos 2011).

In the cycle of experimentation with prototypes the students submit laboratory reports. The main objectives of the reports are:

- a) To generate an experimental work with questions and procedures.
- b) To create a space where students build a mental representation of the phenomenon to be analyzed, before they begin working.

- c) To emphasize the importance of group work by discussing the observations and results through information like graphic, verbal and written.
- d) To generate in the students analysis capabilities around graphical analysis and the theory of error related to the prediction and validation of the observed phenomena.

In, <http://www.fisicacollazos.260mb.com/archivos/P3-electroscopio.pdf>, we show one the reports used by students. All documents referring to this work can be downloaded from (fisicacollazos,2015) in GIREP2014 link.

4. Methodology

4.1. Objective

Measure and assess how The Construction of Prototypes (TCP) and project-based learning (PrBL) increase efficiency in and electrostatic teaching (ET), this at a course in electricity and magnetism with engineering students.

4.2. Justification

By introducing project-based learning in connection with the construction of a prototype it is able to measure the feasibility of its use and convenience of application from pedagogy.

4.3. Research Questions

Do the (PrBL) and (TCP) contribute more meaningfully in the (ET) at the electricity and magnetism course for engineers?

4.4. Hypothesis

The (PrBL) and (TCP) has a gain on the effectiveness of (ET) compared to traditional instruction (TI) projects, since it allows the instructor to design and implement experimental work (theory of error and graphical analysis) and theoretical (physical modeling), also generating other learning at the level of graphic expression, oral and written.

4.5. Pedagogical strategy

In each university we work with 4 experimental groups (traditional course where students work with projects) and with 4 control groups (traditional course where students work without projects). In experimental groups the students developed three projects, (P1), (P2), (P3). The strategy is based on bi-weekly 2-hour activities. We begin with an introduction of the strategy in the first week of classes from the theory class. For this instance are defined sub-group (3 students) and the respective topic. In the first week the students know the basic rules, evaluation (rubric), under which they will define, execute and present projects, in <http://www.fisicacollazos.260mb.com/archivos/Workplan.pdf>, this is the work plan of the semester. In week 3 students did delivery of its preliminary written and oral presentation I. These two activities determine the evaluation 1 (Eva-1). At week 4, the Workshop I was oriented: Oral and Written Expression on oral presentations, written reports and articles. At week 6 we focus Workshop II: Expression Graphic on the design and prototyping in engineering (technical standards, materials etc). By week 8 the students realize the experimental process (prediction, observation, validation) with the prototype and laboratory report detailed in section III -C. At week 10, were delivered 1 written advance and the II oral presentation. These two activities determined the evaluation 2 (Eva-2). At week 12 we oriented the Workshop III: Physical Modeling, Theory and Error and Graphical analysis. We show the main types of models and their interpretation based on prototypes developed and the analysis of experimental data. At week 14 the experimental cycle (prediction, observation, and validation) is repeated with the prototypes to strengthen the theory of error and the graphical analysis. The activities of the week 12 and 14 run from the laboratory. At week 16 in the class of theory was performed III oral presentation and delivery; likewise was received the article wrote in scientific format. These two activities determine the evaluation 3 (Eva-3). The conceptual evaluation is applied for control and experimental groups in the first week of classes (S_i) and last week (S_f).

4.6. Evaluation

Strategy (PrBL) and (TCP) to the (ET) have two types of evaluation, one is the evaluation of projects ((Eva-1), (Eva-2), (Eva-3)) in subgroups of 3 students and the other is the conceptual multiple-choice test that is individual, (S_i) and (S_f).

The evaluation project is structured according to:

- a) (Eva-1): Definition of the proposal: (Week 3: value: 8%).
- b) (Eva-2) Rationale of the project: (week 10: value: 10%)
- c) (Eva-3) Final Results: (week 16: value: 12%)

For the three evaluations were handled the same evaluation criteria and was assessed the oral expression and the written expression; likewise the aspects such as the prototype experimental cycle and feedback. The evaluations are scored on 100 points and students could know in advance the criteria for evaluation. The criteria for evaluation is showed in Figure 2 and the rubric is available in (fiscacollazos,2015).

(Eva-1)	Value	N	P	R	G	E
1. WrittenExpression	20	0	4	11	16	20
2. Oral Expression	20	0	4	11	16	20
3. GraphicExpression	20	0	4	11	16	20
4. Experimental Cycle	30	0	5	11	25	30
5. Feedback	10	0	2	6	8	10
Score						

E : Excellent ; B: Good ; R: Regular ; B : Bad ; P : Poor ; N : None

Figure 2: Evaluation Criteriafor (Eva-1), (Eva-2) and (Eva-3).

The Conceptual test for its part consists of 30 questions that were extracted and translated of the question bank of Mark Riley(Riley,2003). The questionnaire has questions for each of the thematic of the projects (P1), (P2), (P3). The result of the evaluation for projects is 30% of the final grade and the result of the final proof of concept has a value of 5% of the courses Physics (Electricity and Magnetism) for students in engineering programs at both universities. The conceptual test is available in <http://www.fiscacollazos.260mb.com/archivos/Test-Electrostatic.pdf>. The figure 3 show the question 9 of the test.

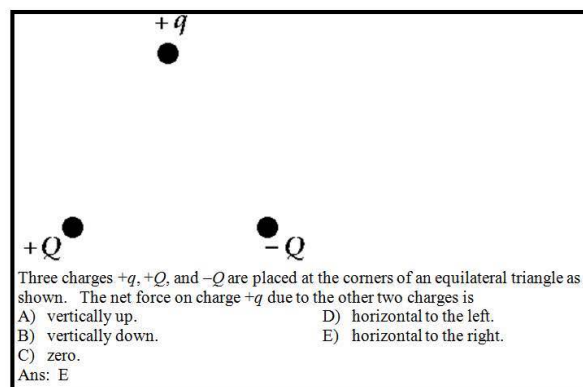

Figure 3: Example of question.

4.7. Population

The pedagogical strategy (PrBL) and (TCP) in the (ET) was applied to 8 groups (experimental group) where 4 groups (156 students) belong to the (MBU) and 4 groups (144 students) belong to the (CSE). Each group consists of approximately 40 students. Subgroups were formed later with 3 students and exceptionally 4 students. In the case of (MBU) 52 subgroups were consolidated, in the case of (CSE) were formed 48 subgroups. Additionally there were 8 groups to which were applied traditional instruction (TI) (Control Group).

5. Results

5.1 Results for evaluation of projects ((Eva-1), (Eva-2), (Eva-3)) and conceptual multiple-choice test((S_i) and (S_f))

Using Hovland's concept of gain, Hake defined the gain g by equation (1) (Hake, 1997).

$$g = \frac{S_f - S_i}{100 - S_i}$$

(1)

Where $g=0$ if (S_i)=100; (S_f) (Post-Test) corresponds to the conceptual test applied after applying the strategy (PrBL) and (TCP) to the(ET). (S_i)(Pre-Test) corresponds to the entrance test without applying any strategy or traditional instruction (TI). We proceeded to determine the average gain of each of the 4 experimental groups and 4 control groups before and after applying the strategy and traditional instruction in (CSE) and (MBU). Ordering the equation (1) we have the equation (2) for evaluation for projects.

$$g = \frac{(Eva3) - (Eva1)}{100 - (Eva1)}$$

(2)

Based on theoretical Fundamentals of Hake, the mathematical models were obtained for each educational process. Figure 4 shows all groups (control and experimental) in (MBU) and (CSE), indicating the gain and the classification provided by (Hake, 1997). Figure 4 also shows that the gain for the (MBU) with (PrBL) is (30.43 ± 2.08) and is located in medium gain, but with (TI) is (13.04 ± 1.14) and is located in low gain. For (CSE) with (PrBL) is (46.52 ± 1.88) and is located in medium gain, but with (TI) is (17.48 ± 1.23) and is located in low gain. The results show the efficiency of (PrBL) in contrast to the (TI) at both universities.

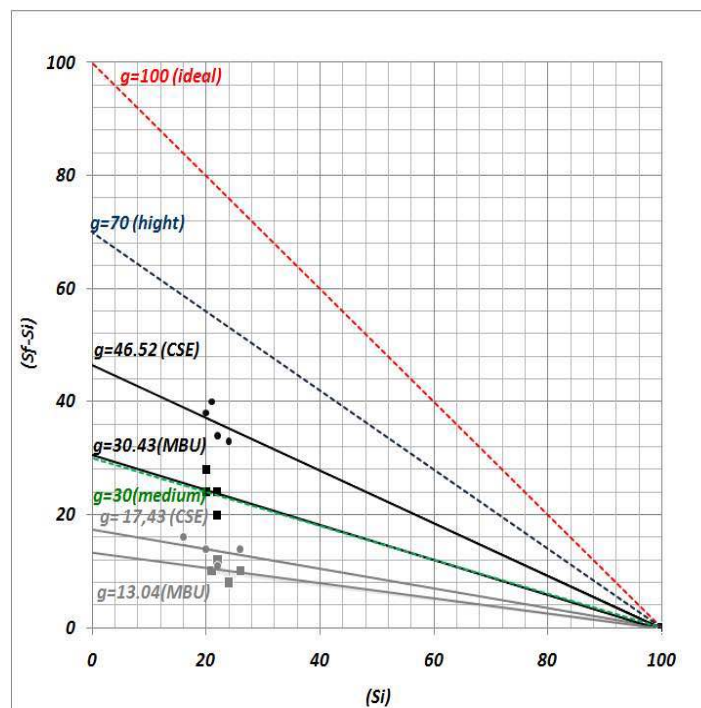

Figure 4: Experimental (black) and control (gray) groups (CSE, MBU), red (ideal: $g = 100$), blue (high: $g \geq 70$), green (medium: $70 > g \geq 30$), low ($g < 30$)

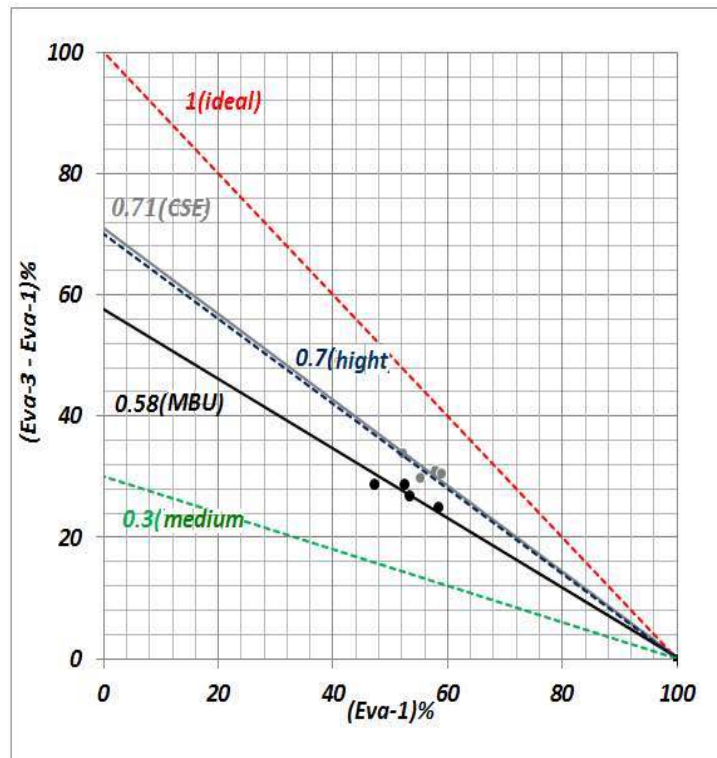

Figure 5: Experimental groups for MBU (black) and Experimental groups for CSE (gray), red (ideal: $g = 100$), blue (high: $g \geq 70$), green (medium: $70 > g \geq 30$), low ($g < 30$)

Figure 5 shows all groups (experimental) in (MBU) and (CSE), indicating the gain and the classification provided by (Hake, 1997). Figure 5 also shows that the gain for the (MBU) with (PrBL) is (58 ± 2.08) and is located in medium gain. For (CSE) with (PrBL) is (71 ± 2.88) and is located in high gain. The results show the efficiency of (PrBL) in contrast to the (TI) at both universities.

5. Conclusions

For the three projects (P1), (P2), (P3) and for two universities (MBU) and (SCE) we state that students: Worked actively and collaboratively in the implementation of projects. Could establish a process for testing (prediction, observation, and validation) with the prototypes developed. (Although the study of the electrostatic).

The students recognized variables and constants in the physical models involved in the prototypes. Was used in a manner acceptable the error theory and graphical analysis. It showed that the oral and written presentations of design and construction of the prototype are of great importance because this prepares students in their daily work.

Finishing the projects (P1), (P2), (P3), based on the results observed in (MBU) and (SCE) showed that students took into account almost all suggestions made at the level of oral and written presentations. We could see security and enthusiasm in presentations perhaps due to the results achieved. In the written deliveries was observed compliance in the style guidelines provided and the use of figures, text and equations themselves. With regard to prototype design, students get graphic designs from the appropriate expression. On the experimental cycle, reinforcing the theory of experimental error and graphical analysis, of entry could be noted that their analyses have some errors, but they managed to overcome these shortcomings and made a good presentation on their projects. At the level of the feedback we consider that students could actively participate in Workshop III, in this stage of the evaluation it was concluded that students have a good use of the word processor, spreadsheet, and presentation program and design.

Acknowledgements

The authors express their gratitude to the Laboratory of Management of Manuela Beltrán University and the Faculty of Natural Sciences of Colombian School of Engineering and Center of Research in Applied Science and Advanced Technology of National Polytechnic Institute, for the support provided in this research.

References

- Ausebel, D. *Psicología Educativa, Un punto de vista cognoscitivo*, (Ed. Trillas, México, 1986).
- Blank, W. (1997). Authentic instruction. In W.E. Blank & S. Harwell (Eds.), *Promising practices for connecting high school to the real world*, (pp. 15–21). Tampa, FL: University of South Florida. (ERIC Document Reproduction Service No. ED407586).
- Collazos, C. A. (2009a), Prototipo para la Enseñanza de la dinámica rotacional (conservación del momento angular), *Lat. Am. J. Phys. Educ.* **3**, 446-448.
- Collazos, C. A. (2009b), Enseñanza de la conservación del momento angular por medio de la construcción de prototipos y el aprendizaje basado en proyectos, *Lat. Am. J. Phys. Educ.* **3**, 428-432.
- Collazos, C. A. (2009c), Prototipo para la Enseñanza de la dinámica rotacional (Momento de Inercia y teorema de ejes paralelos), *Lat. Am. J. Phys. Educ.* **3**, 619-624.
- Collazos, C. A. y Mora C. E. (2011), Prototipo para medir Fuerza Centrípeta en función de masa, radio y periodo, *Lat. Am. J. Phys. Educ.* **5**, 520-525.
- ficacollazos, Web page Of Carlos Collazos, <http://www.fisicacollazos.260mb.com/?cat=46>, Visited in January 15, 2015.
- Gil, D. y Payá, J. (1988). Los trabajos prácticos de Física y Química y la metodología científica. *Revista de Enseñanza de la Física* **2**(2), 73-79.
- Hake, R. R. (1997). Interactive-engagement versus traditional methods: A six-thousand-student survey of mechanics test data for introductory physics courses, *American Journal Physics*. **66**, 64-74.
- Hernández, C. (2004). *Aprendizaje de la Física en estudiantes de diseño Industrial dentro de una innovación pedagógica consistente en el constructivismo*, Tesis de Maestría en Educación, Uniandes.
- Kelly, J. (1999). Rethinking the elementary science methods course, a case for content y pedagogy and informal science education, *International Journal of Science Education*. **14**, 755-777.
- Piaget, J. (1969). *Psicología y Pedagogía*, España. Ed. Ariel
- Riley M. (2003). *Test Bank*, New York (NY)-USA. Ed. W. H. Freeman and Company.
- Thomas, J. W. (2008), *Project based learning overview*, (Novato, CA. Buck Institute for Education. <http://www.bie.org/pbl/overview/index.html>). Visited in July 15, 2014.

Multiple Bounces of Different Material Balls in Free Fall

Armando C. Perez Guerrero Noyola, Fernando Yañez Barona.

Departamento de Física, Ciencias Básicas e Ingeniería. Universidad Autónoma Metropolitana- Iztapalapa,

Abstract

In this work, we present a proposal for a more dynamical experimental physics course for physics and engineering students of the Universidad Autónoma Metropolitana. Unidad Iztapalapa (UAM-I) in Mexico City. The aim of this proposal is to teach students how to analyze with experiments, the problems that they solve in their theoretical courses. The idea is to integrate Mechanics I, Waves and Rotations and Differential Equations courses with topics that must learn in their experimental courses, such as the use of spread sheets and video analysis. This proposal is not resolved in textbooks and students enjoyed the experience. Students observed and described the behavior of three different material balls falling freely until they arrive to the floor. We consider that learning strategy would be very useful for our experimental courses.

Keywords

University education, Laboratory activities, Teaching strategies, physical modeling, theoretical analogy, simulation phenomena.

1. Introduction

The presented work was carried out in the course “Experimental Method II”, which is part of science and engineering curriculum at the Universidad Autónoma Metropolitana – Iztapalapa (UAM-I). Fernando Yañez Barona was one of the students that participate in this experience.

At this level, students know about mechanical waves and rotations, basic calculus and begin to solve basic differential equations. In this course, students learn to analyze experimental data. Term in the UAM-I lasts only three months so time students spend in the laboratory must be use wisely to get the best learning. At the UAM-I, the physics experimental courses are independent from theoretical courses, so students usually do not relate problems they solve in theoretical courses with the work in the laboratory. Students feel that this is a very technical course where they only measure and analyze experimental data, without understanding the physical phenomena involved in the experiments. They feel disappointed and therefore they underestimate curricular value of experimental courses.

In this work, we designed a research sequence on physics taking into account the objectives of the course and giving students fulfillment and meaning to the experimental courses as well as the theoretical ones. In this case, students were requested to use their theoretical knowledge to explain the how different types of balls bounce on the ground and on their desks, and at the end they were capable of propose a mathematical model in order to explain the phenomenon.

The didactic goal was to involve students in an experiment that might seem simple but include physical, mathematical, computer and multimedia tools. Students were free to reach the results they could or they wanted.

2. Experimental methodology

Students had to observe the movement of three balls (a sponge ball, a ping-pong ball, and a golf ball) bouncing on the ground. Firstly, they listened to bounces until they stopped. Secondly, they drew the path of each ball as they saw it moving. Consequently, they suggested hypothesis for the consecutive bounces and they proposed the variables to be measured, how to measure them, why they chose those variables and how they would use them in case they needed them in the next analysis. They repeated the experiment but over their desk and finally they replaced the balls by their notebooks which also fell freely from the same height. Obviously, they noticed that the notebooks did not bounce.

After this qualitative analysis, with the help of the teacher, they decided to measure how high the balls went up after each bounce and the time between bounces. In order to measure distances, some students chose a

tape measure, others chose a one-meter rule. For measure time, they used chronometers. With these data they plotted the height versus time. In the first instance, they believed that their measurements were the best they could get, but afterwards they realize that only the initial height, which they fixed, was easy to measure, while for the next heights were difficult to obtain with high accuracy, high precision and repeatability. They were also surprised to notice that the heights reached depended on the type of ball and that in order to get a graph similar to the one they drew before, they needed more data. For time measurements, they found that as balls heights were smaller, time was more difficult to obtain. At this stage, the principles of good measurements could be taught. There was a discussion of measurement uncertainty followed by a lecture of the procedures for quantifying and reducing measurement errors. Although, in the following stages, as the objectives were different, students did not always calculate the measurement uncertainties.

The next stage was then to suggest other ways for measure the variables chosen in order to be able at the end, to model collisions, of the balls and the notebook, with the ground and desk. Then the teacher proposed to record the movement with their cell phones and to use the image and video analysis package *Tracker*, then analyze how the path of the ball changed with time and thus to calculate its speed.

The students acquire skills using their laptops, tablets and cell phones. From the graphs, they learned that with *Tracker*, they could visualize the path of the movement of ball and obtain the maximum heights as a function of time (Figure 1). Actually, the graph of maximum heights versus time (h vs t) is a discrete one, were points are disconnected one from each other. But, the students noticed that in that graph, if they interpolated the points, as it was a continuous phenomena, and they connected all with a line, they had a nonlinear behavior similar to an exponential decay that could be analyzed with Excel software in order to find the mathematical relation between maximum heights and time. At this stage, students reinforced their knowledge about graph analysis.

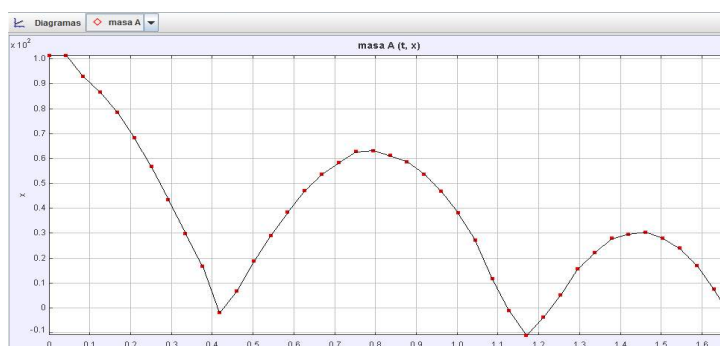

Figure 1. Plot Height versus time for n successive bounces obtained with Tracker

By the other hand, from their theoretical courses, the students had already learned the law of conservation of energy and they knew how to analyze the movement of an object that falls and hit the ground. Here, they noticed that the object (in this case the balls), bounced several times at hitting the ground and at each bounce, the maximum heights reached were smaller, so they were aware that the maximum heights reached by the balls decreased because of the energy lost during the bounces. Then with the h versus t plot, they could analyze the lost of energy due to bounces.

In their theoretical courses, the students also had studied about elastic and inelastic collisions, so they proposed to calculate the ball speed when it hit and when it left the floor. At this stage of the research, they began to introduce the energy conservation to obtain the speed.

In order to be able to model the complete phenomena, as a hint, the teacher reminded the students the theoretical problem of a body that slides without friction on an incline plane that compress a spring at the end of the movement. How far the body goes back when it collides with the spring at the base of the plane? All students considered that the body reached always the same height. Changing the plane angle until 90 degrees, the body freely fall and bounce when strikes the spring. The aim of the hint was to guide students to model the experiment they were doing, simulating the ball bounce phenomena with mechanical elements such as springs and bumpers. With this analogy and the h versus t plot in mind, and after reading about the damped harmonic oscillator, they could already deduce that they could compare the ball bounces to a mass-spring-damper system.

Then, the teacher proposed to determinate the force that pushed the ball up and to find why their notebooks did not bounce. He also, asked them, knowing the initial height, to predict the height the balls reached after the next bounces. From concepts learned on theoretical courses, the students proposed to obtain the linear momentum before and after each bounce.

From the second Newton's law, in the case mass-spring-damper, the net force can be related with the rate of change of linear momentum and from the third Newton's law, forces applied on the ground gives as a result a force equivalent to the normal force that push the ball up. By the other hand, the normal force is distributed in the contact area if the ball undergoes a big deformation, the contact time is longer and the normal force per area decreases and the force up is small, but if the ball undergoes a small deformation, the contact time is shorter and the normal force per area increases and the force up is very big. This observation explain why notebook doesn't bounce as a small ball.

When the students had already their own mathematical model, they could compare with other models found in literature or in websites. For instance, in the website www.sc.ehu.es/sbweb/fisica/ of Angel Franco Garcia, the multiple bouncing of one ball is described. In the website there is an analysis of the ball height with the number of bounces. Garcia found an iterated relation for each bounce and then he extrapolated to the case of a temporary relation. At this stage, we review the concepts of kinetic and potential energies, linear momentum, impulse and energy conservation law

Finally, the students realized that the essential difference between force and energy was so clear in this case, since the weight of each ball did not change, however the potential energy, dependent on height, varied according to the behavior of the coefficient of restitution and not of falling force, as this is always the same.

3. Theoretical analysis

In this section we briefly describe the process followed in the operational part of the experiment. Here we explain the mathematics that we used; with the assumption of inelastic collisions between the ball and the floor.

Restitution coefficient

It is known that in a frontal collision of two solid spheres, such as those billiard balls, balls speeds before (v_1, v_2) and after (v'_1, v'_2), the collision are related by the expression (Hibbeler, 1997),

$$v'_1 - v'_2 = -\epsilon(v_1 - v_2) \quad (1)$$

This relation was proposed by Newton, and ϵ is the coefficient of restitution (figure 1). The students used this theoretical result, but they did not experimentally confirm it, but if the term was longer could be a nice experiment to be done at the classroom.

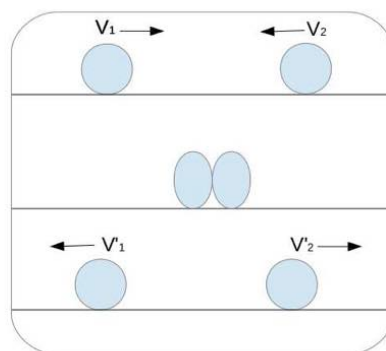

Figure 2. Elastic shock in a plane.

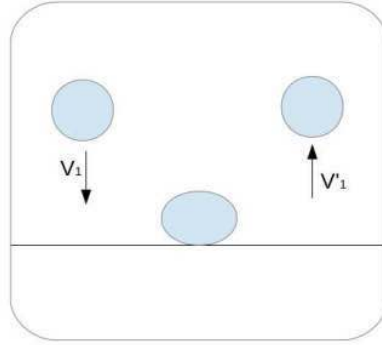

Figure 3. Inelastic shock of a ball hitting the ground while free falling.
In this case the floor do not move ($v_2 = v'_2 = 0$).

Successive bounces a ball with the ground.

At the ground, considering the ground as the second ball, $v_2 = v'_2 = 0$. And the equation (1) is reduced to (Figure 2),

$$v'_1 = -\varepsilon v_1 \quad (2)$$

First bounce

Initially, the ball is at rest in a height h_0 , that is, gravitational potential energy is maximum. In free fall just before the crash downward, the speed v_1 must satisfy the energy conservation principle:

$$mgh = \frac{1}{2}mv^2 \quad (3)$$

According to equation (2), the ball speed after shock is $v'_1 = -\varepsilon v_1$, that is, the speed at which the ball goes up and reaches a height h_1 , calculated by applying again the principle of conservation of energy:

$$\frac{1}{2}mv_1'^2 = mgh_1 = \frac{1}{2}m\varepsilon^2v_1^2 \quad (4)$$

$$h_1 = \varepsilon^2h_0 \quad (5)$$

Second bounce

We can proceed in the same way for the second bounce, when the ball falls freely from the height h_1 . The ball speed v_2 before the second collision with the ground is calculated by the principle of conservation of energy:

$$\frac{1}{2}mv_2^2 = mgh_1 \quad (6)$$

Again, equation (2) tells us that the speed of the ball after the second shock is $v'_2 = \varepsilon^2v_2$. Then, the ball goes up with the v'_2 speed and reaches a maximum height h_2 which is calculated using the principle of conservation of energy:

$$mgh_2 = \frac{1}{2}mv_2'^2 = \frac{1}{2}m\varepsilon^2v_2^2$$

(7)

Substituting equations (5) and (6) we arrive at

$$h_2 = \varepsilon^2 h_1 = \varepsilon^4 h_0 \quad (8)$$

Height versus time

Now it is easy to infer from the equations (5) and (8) that the maximum height, then of n successive bounces, is given by

$$h_n = \varepsilon^{2n} h_0 \quad (9)$$

we must remember that $0 \leq \varepsilon \leq 1$.

Required time for the ball to stop

The time the ball need to reach the ground when dropped from an initial height h_0 from rest can be calculated from the motion equation of a particle moving at constant acceleration:

$$y_f = y_0 + v_0 t - \frac{1}{2} g t^2 \quad (10)$$

Where $y_f = 0$, $y_0 = h_0$ and $v_0 = 0$ i.e, we obtain that, once the ball hits the ground, it bounces, goes to a height h_1 and then falls back to the ground. The time it takes to go up and down is:

$$t_1 = 2\sqrt{\frac{2h_1}{g}} = 2\sqrt{\frac{2\varepsilon^2 h_0}{g}} = 2t_0 \varepsilon.$$

(11)

The ball bounces a second time and reaches a height h_2 , and falls back to the ground. The time it takes to get up and down is:

$$t_2 = 2\sqrt{\frac{2h_2}{g}} = \sqrt{\frac{2\varepsilon^2 h_1}{g}} = 2\sqrt{\frac{2\varepsilon^4 h_0}{g}} = 2t_0 \varepsilon^2 \quad (12)$$

Then it is clear that the time the ball takes up and down after the n bounce is

$$t_n = 2t_0 \varepsilon^n \quad (13)$$

Here, we can use this expression to calculate the total time after infinite bounces as the sum of the individual times between the bounces; i.e.

$$t_\infty = t_0 + t_1 + t_2 + \dots = t_0 [1 + 2\varepsilon (1 + \varepsilon + \dots)] \quad (14)$$

The terms between round brackets is a geometric series then,

$$t_\infty = t_0 \left(1 + \frac{2\varepsilon}{1-\varepsilon} \right) \quad (15)$$

That is,

$$t_\infty = \sqrt{2\frac{h_0}{g}} \left(\frac{1+\varepsilon}{1-\varepsilon} \right) \quad (16)$$

Note that if $\varepsilon = 0$ the time the ball needs to stop is exactly t_0 , which means that the ball loses its energy in the first collision with the floor. But if $\varepsilon = 1$, the ball bounces indefinitely ($t_\infty \Rightarrow 1$) since there is no energy dissipation. The time t_n , the ball remains in the air between n and $n + 1$ bounces at the ground is given by equation (13) which can be written as

$$\ln t_n = n \ln \varepsilon + \ln(2t_0) \quad (17)$$

Where we have taken the natural logarithm of both sides of the equation (13). Equation (17) is the equation of a line of the form $y(x) = mx + b$, (figure 4)

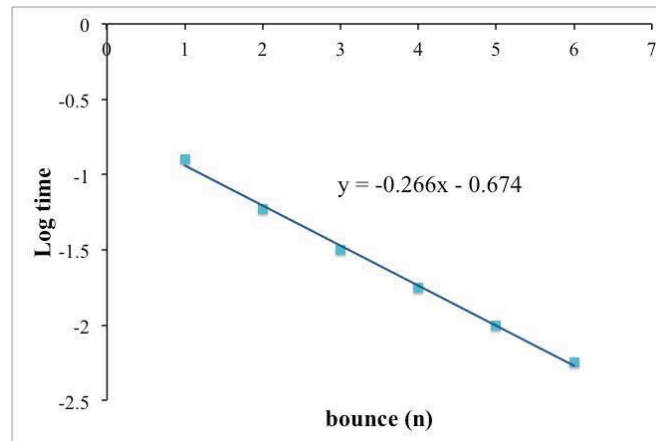

Figure 4. Logarithm of time versus numbers of bounces

This means that if we plot $\ln t_n$ versus n , we get a straight line of slope $m = \ln \varepsilon$ and y-intercept $b = \ln(2t_0)$, with t_0 given by equation (13). If m is determined from experimental data (figure 4), we can calculate the coefficient of restitution

$$\varepsilon = e^m \quad (18)$$

It is noteworthy that ε is important in determining how much energy is dissipated by the bounces

Damped harmonic oscillator model

In the experiment, three different material balls (a sponge ball, a ping-pong ball, and a golf ball), were dropped from the same initial height. Firstly, they were dropped on the ground and after on the students desk. For each ball the experiment was repeated 10 times. On the ground, the students observed that the behaviors of the ping-pong and a golf balls were very similar, in spite of their different mass and textures. The sponge ball, which the smooth one, reached a smaller heights and bounced less. On the desk, the behaviors of the ping-pong and a golf balls were also very similar, as well as the sponge ball reached a smaller height and bounced less. But, in this case, the sponge ball, reached higher heights and bounced more than when it hit on the ground.

The students were astonished to found theses behaviors of the balls, and they wanted to explain what happened. Their physical knowledge at this level of their studies, is not enough to understand what really happened when they change the material, but if we use a simple analogy using the theoretical concepts they know, it is possible to obtain a reasonable explanation of the phenomena, as well is a nice to introduce students to the art of model physical phenomena. Then, the teacher proposed them to consider that the balls behave like a mass-spring-damper system (figure 5) and we present here the mathematical considerations.

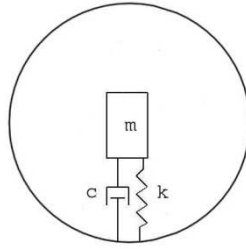

Figure 5. Balls bouncing from the ground is modeled as a combined system mass, spring and damper

From the equation of motion of a damped harmonic oscillator (French, 2003), we have,

$$h_n(t) = h_0 e^{-\gamma t} \quad (19)$$

where, γ is the damping coefficient. $e^{-\gamma t}$ represents the envelope of the oscillation and it depends on the rate of decay of the amplitude, that is, it is associated with the loss of energy.

As we are considering that the ball behave like a spring-mass-damper system, if we compare the last expression, with the one obtained from the curve height vs time plot where h can be related with the coefficient of restitution (equation 9), and if h_n is the maximum height after the n th bounce (Figure 6), we obtain,

$$-\gamma t = 2n \ln \varepsilon \quad (20)$$

Actually, we must remain that the plot of maximum heights versus time (h vs t) is a discrete plot, where points are disconnected one from each other and that we arrived to this analogy from the students proposal of interpolate the points, as it was a continuous phenomena, and to outline all with a smooth curve, in order to have a nonlinear behavior of the loss of energy during time, similar to an exponential decay.

Then, the energy can be written as function of the number of bounces as follows:

$$E(n) = mgh_0 e^{-2n \log \varepsilon} \quad (21)$$

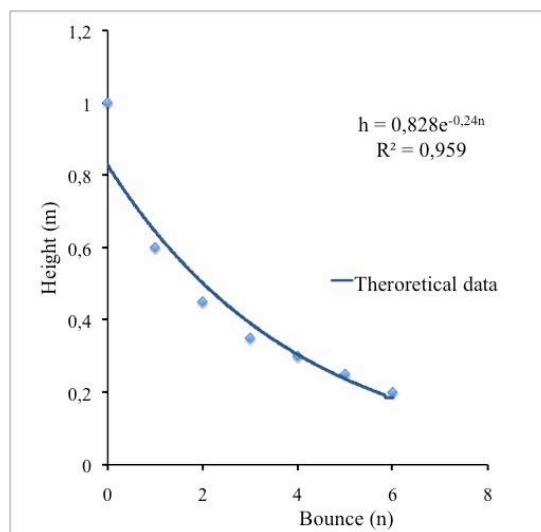

Figure 6. Height versus bounce. Comparison of theoretical data (from model) and experimental data.

4. Conclusion

It is important for us to highlight that to use examples that contain a lot of physical concepts can be reinforced by experimental practice. The participation of the students was markedly enhanced with the feeling that each class was a challenge for them. The cooperation between the students from different majors made each one to use their skills in order to obtain the best results. But as the same time, it was really amazing, to experience the competitive atmosphere between work groups of students during one month and a half, 6 hours a week. Between, students interested on study a physics major, were very interesting debates of the phenomenon, while students interested on study an engineering major were more practical.

The use of software and computers as well as multimedia through their cell phones was an important knowledge acquired to achieve the goal. Although, at the end, it was more important the model than the measurement errors and uncertainties, at the beginning of the experience there was a nice analyze of them.

The aim of the experience would not be reached if the students did not understand the physical concepts so close as force and energy and how they are related with a non conservative systems. They learned how to use simple analogies and they could build a model with which is was possible to have a reasonable explanation of what they observed in the experiment, although they have not yet the knowledge of the study of the deformation of solids.

They realized how changing the features of a mass-spring-damper system, could simulate the different behavior when the material of ball was changed. They understood that if an elastic material (sponge ball) is pressed against the floor, the contact area increases. Then pressure decreases, the force that does not change, is not anymore applied to a point but to a bigger contact area, giving as a result a less bounce. This is also the reason why the notebook does not bounce.

The students also could associate the restitution coefficient with the different materials, and they understood that how inelastic and elastic collisions depend on it.

References

French, P. A.. (2003) *Vibrations and waves*. MIT Introductory Physics series. CBS Publisher and Distributor. USA

Hibbeler, R.C., (1997). *Engineering Mechanics: Dynamics*. 8th ed. Prentice Hall College Div. USA.
www.sc.ehu.es/sbweb/fisica_/ of Angel Franco García

Affiliation and address information

Armando Cuauhtémoc Pérez Guerrero Noyola and Fernando Yañez Barona

Departamento de Física.

Area de Mecánica Estadística

Universidad Autónoma Metropolitana -Iztapalapa

San Rafael Atlixco 186, Col. Vicentina,

09340 México, D.F.

acpgn@yahoo.com

An Inquiry-Based Approach to the Franck-Hertz Experiment

Dominique Persano Adorno, Nicola Pizzolato

*Physics Education Research Group
Department of Physics and Chemistry, University of Palermo,
Viale delle Scienze, Ed.18, 90128 Palermo - Italy*

Abstract

The practice of scientists and engineers is today exerted within interdisciplinary contexts, placed at the intersections of different research fields, including nanoscale science. The development of the required competences is based on an effective science and engineering instruction, which should be able to drive the students towards a deeper understanding of quantum mechanics fundamental concepts and, at the same time, strengthen their reasoning skills and transversal abilities. In this study we report the results of an inquiry-driven learning path experienced by a sample of 12 electronic engineering undergraduates engaged to perform the Franck-Hertz experiment. Before being involved in this experimental activity, the students received a traditional lecture-based instruction on the fundamental concepts of quantum mechanics, but their answers to an open-ended questionnaire, administered at the beginning of the inquiry activity, demonstrated that the acquired knowledge was characterized by a strictly theoretical vision of quantum science, basically in terms of an artificial mathematical framework having very poor connections with the real world. The Franck Hertz experiment was introduced to the students by starting from the problem of finding an experimental confirmation of the Bohr's postulates asserting that atoms can absorb energy only in quantum portions. The whole activity has been videotaped and this allowed us to deeply analyse the student perception's change about the main concepts of quantum mechanics. We have found that the active participation to this learning experience favored the building of cognitive links among student theoretical perceptions of quantum mechanics and their vision of quantum phenomena, within an everyday context of knowledge. Furthermore, our findings confirm the benefits of integrating traditional lecture-based instruction on quantum mechanics with learning experiences driven by inquiry-based teaching strategies.

Keywords

Inquiry-based learning, Quantum Mechanics, Franck-Hertz Experiment

1. Introduction

The fields of nanoscience and nanotechnology are rapidly advancing, together with their significant applications and implications. Several challenges are connected with a full scientific understanding of the world at nanoscale and related concepts; thus, the education of science/engineering undergraduates on these fundamental topics is crucial to the scientific and technological progress [1-3]. The development of the required competences is based on an effective science and engineering instruction, which would be able to drive the students towards a deeper understanding of Quantum Mechanics (QM) fundamental concepts and, at the same time, strengthen their reasoning skills and transversal abilities [4]. On the other hand, a careless simplification of the sophisticated concept of nanoscience could generate misconceptions, lead to superficiality and risk of misrepresenting. At this regard, an instruction based on scientific inquiry represents the natural framework to develop opportunities of learning science concepts in terms of an active construction of meaningful knowledge and to stimulate high levels of critical thinking skills [5].

In inquiry-based learning environments, the students are engaged in identifying scientifically relevant questions, planning investigations, gathering data and evidences in laboratory and/or real life situations, building descriptions and explicative models, sharing their findings and eventually addressing new questions that may arise [6]. Being these activities the same real scientists carry out when perform their investigations, this learning cycle is considered the most effective way for developing scientific knowledge and stimulate the strengthening of reasoning skills. However, depending on the amount of support provided by the teachers, the students may be involved in *structured*, *guided*, or *open inquiry* [7-9]. In structured inquiry both the question and the explorative procedure are provided by the teacher, but students strive to generate their

own explanations on the basis of their investigation results. In guided inquiry the teacher provides students only with the research question, and students plan the procedure to test their working hypothesis, design and carry out their own experiments, draw conclusions. In open inquiry the teacher introduces the context by presenting a multidisciplinary view of a theoretical problem or a real-life phenomenon. Subsequently, the students define their relevant questions, design and carry out their own investigations, communicate and share their results. An open inquiry-based instruction seems more efficient to reinforce learners' reasoning skills, also increasing the awareness of the process of scientific inquiry and of the nature of science [10-12]. In this context, the role played by the teacher is fundamental for the achievement of the desired results. In fact, it seems that a more structured/guided instruction should provide the students with competencies more focused on conceptual knowledge, leaving the learners with a not well defined view of how scientific knowledge is produced, while a more open approach would let the students to experience the world with a higher level of autonomy, developing higher-order thinking skills [13]. Despite this, students involved in open inquiry may develop feelings of frustration due to the lack of achieving the desired goals independently from teacher's hints [14].

In this study we address the question of the efficacy of a structured inquiry-based learning approach, with different levels of teacher's guidance, to introduce the students to fundamental aspects of QM in the context of the Franck-Hertz experiment, in order to find the most suitable teaching approach to develop a deeper understanding and comprehension of the QM concepts.

In the following, we briefly introduce the method and research questions addressed in this paper, then describe the details of the Franck-Hertz experiment carried out by a sample of engineering undergraduates and, finally, report and discuss the results. Concluding remarks on the most effective scaffolding structure to be used in order to stimulate and elicit the students' scientific inquiry through their path of exploration are reported at the end of the paper.

2. Method and Research Questions

This study presents the results of an inquiry-driven learning path experienced by a sample of 12 master students in electronic engineering at the Laboratory of Condensed Matter Physics at the Department of Physics and Chemistry, University of Palermo, Italy. Before being involved in this experimental activity, the students received a traditional lecture-based instruction on the fundamental concepts of QM. Despite the efforts of introducing specific technological and engineering-based applications of QM during traditional courses, students' answers to an open-ended questionnaire, administered at the end of the theoretical lectures, demonstrated that the acquired instruction was characterized by a vision of quantum science basically in terms of an artificial mathematical framework, with poor connections with the real world. This could be ascribed to the many difficulties that students demonstrated to hold in order to deal with concepts at scales in which they cannot have a direct experience during their everyday life, especially at microscopic and sub-microscopic scales. Moreover, students still prefer to conceptualize matter as being continuous rather than discrete.

In order to fulfill these lacks, driven by the idea that inquiry-based laboratory experiments exploring quantum phenomena may provide the students with motivation for an effective comprehension of QM concepts, the students were invited to join an experimental activity concerning the Franck-Hertz experience. First, the Franck-Hertz experiment was introduced to the students by starting from the problem of finding an experimental confirmation of the Bohr's postulates asserting that atoms can absorb energy only in quantum portions. After that, the students were driven by two instructors through a reasoned sequence of experimental steps, carried out within an inquiry-based learning environment, towards the visualization and discussion of the experimental results.

The students were first engaged in a traditional *structured inquiry* [9], then involved in a learning path with a specific process of activation - *Elicited Inquiry* -, consisting of a structured inquiry in which two or more instructors actively participated to the debate on the physics governing the observed phenomena, never providing exhaustive explanations to the students, but giving comments and hints, sometimes expressly incorrect, always leaving the students in a state of uncertainty, stimulating their reasoning and activating their scientific inquiry.

At the end of their inquiry-based learning path the students were asked to answer to a structured interview with questions similar to those proposed by means of the initial questionnaire. Moreover, the whole activity was videotaped for a deeply analysis of the student perception's change about the main concepts of QM.

The results reported in this paper are based on the analysis of videotaped data, analyzed on the basis of an in-context search for key-words or phrases and specific aspects of the student's behaviour (speech and gesture events) that could give evidence of their cognitive processes.

The analysis of all these data allowed us to answer the following two main research questions:

- Can an inquiry-based method of instruction be successfully applied to achieve an effective understanding of QM concepts?
- Which is the most suitable inquiry-based teaching/learning strategy for QM?

3. The Franck-Hertz experiment

The famous experiment of Franck and Hertz, carried out in 1914, consisted in bombarding mercury atoms by electrons, and detecting the kinetic energy loss of the scattered electrons. In particular, they showed that electrons could impart energy to a mercury atom only if the electrons had a kinetic energy exceeding 4.9 eV. This was the first direct proof of the quantized nature of energy transfer, postulated by Niels Bohr in 1913, showing directly that quantized energy levels in an atom are real, not just optical artifacts.

The apparatus for this experiment consists of a mercury-filled Franck-Hertz tube, a control unit with power supplies and a DC current amplifier with a shielded cable. The power supply section of the control unit delivers the accelerating voltage (continuously variable from 0 to 30 V), the filament heating voltage for the tube (up to 7 V), and the retarding voltage (up to 5 V). The accelerating potential can be adjusted manually or swept automatically. The apparatus is pictured in the left panel of Figure 1.

Electrons are thermally emitted from the cathode and they are accelerated toward the collector electrode by an attractive potential. A control grid helps to keep the emission current constant as the accelerating potential is varied. Electrons that pass through the control grid are accelerated by the potential added between the cathode and the anode. Electrons passing through the anode with an energy greater than the retarding voltage applied to the collector electrode are collected at the plate and give rise to a plate current that is measured with a sensitive current- to-voltage amplifier connected to a voltmeter (Figure 1, right panel).

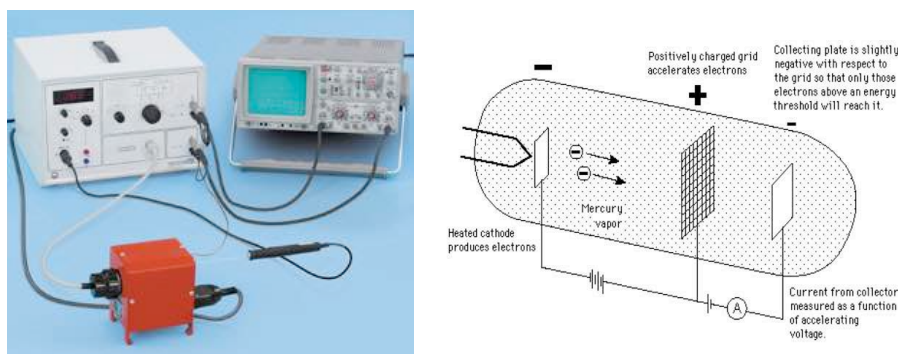

Figure 1. Experimental set-up for the Franck-Hertz experiment (left) and schematic representation of the mercury-filled Franck-Hertz tube (right).

The mercury tube should be turned on for approximately 60 min to allow the unit to stabilize at a temperature of about 180 °C. The experiment proceeds by slowly increasing the accelerating voltage from the initial value. The current increases uniformly, reaches a maximum, and then decreases as the accelerating voltage is increased. A reduction in collector current occurs starting at about 4.9 V. This is accompanied by the appearance of a glowing red layer at the anode. As the anode voltage is increased, the collector current decreases and the glow moves toward the cathode. The emission current must be at a low enough level so that gas discharge does not occur. The retarding voltage between anode and collector electrodes should be properly set so that the minima in the current voltage curve are clearly recognizable. The data were collected manually by the students reading a digital oscilloscope (Figure 2, left panel) and were plotted on a Current-Voltage diagram (Figure 2, right panel).

4. Results

The students were first invited to perform the Franck-Hertz experiment by following the scaffolding lines of a *structured inquiry*-based learning path of exploration. In particular, the students were introduced into the laboratory, being already prepared by the instructors on the physical problem to address (the same faced by Franck and Hertz on demonstrating the existence of the quantum energy levels), and invited to follow the

educators' instructions for what concerns the procedure to carry out, in order to get to the necessary physical conditions (mercury-filled tube temperature and voltages) for the data collection.

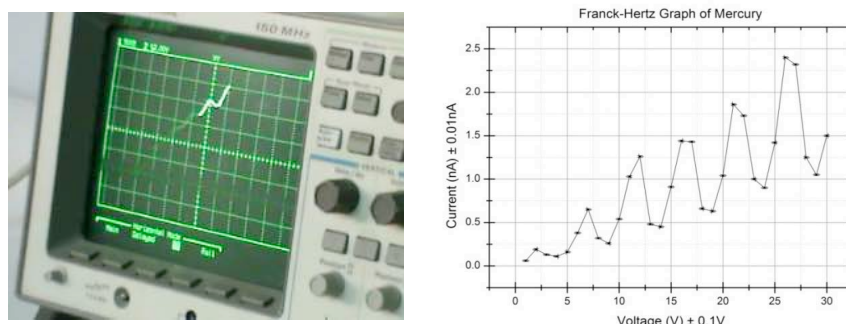

Figure 2. Franck-Hertz Experiment: Experimental data gathered by the students manually from the oscilloscope (left) and plotted on a Current-Voltage diagram (right).

By following the lines of a scientific inquiry, the students, working in group, were asked to perform a questioning activity that naturally should have guided them throughout the steps of the Franck-Hertz experiment. However, despite the students' diligence on performing the several steps of this experiment, they encountered many difficulties to generate their own explanations on the basis of their investigation results, and several times they went stuck on a stance. At this stage, the two instructors decided to take part in the discussion with the students, by taking the role of inexperienced learners and to actively participate to the debate on the physics governing the observed experimental findings. The instructors never provided the students with exhaustive explanations, but, on the contrary, they expressed personal opinions and comments, sometimes expressly incorrect, always leaving the students in a state of uncertainty. This educators' behavior proficiently elicited students' scientific inquiry - *Elicited Inquiry* -, stimulating reasoned discussions and activating new cognitive resources allowing them to surmount their difficulties and draw convincing evidences of the experimental results.

The whole activity has been videotaped and this allowed us to deeply analyze the students' behavior and perception's change about the main concepts of QM. These data were treated by performing a *discourse analysis* and a *gesture analysis*, which both contributed to highlight the benefits of this inquiry-based strategy of instruction.

Discourse analysis

Distributed cognition treats thinking not as an action that takes place wholly inside an individual's head, but rather as a distributed activity among other people and their language [15]. By following these basic ideas, we have analyzed the videotaped data gathered during the inquiry-based learning experience carried out by our students, in order to explore their learning process from the widest point of view. To this aim, we have selected seven different kinds of speech events (SE) (adapted from [16]) and recorded the percentage of students showing these SE during the performance of the Franck-Hertz experiment. The data were taken both during the first initial phase of traditional structured inquiry and after the succeeding inquiry with the intervention of instructors' elicitation. In table 1 we report the observed percentage. The main result of this study is that the students engaged into a tradition structured inquiry show very low percentages of involvement into *Elicitation of critique*, *Contextualization of research*, *Negotiation* and *Consensus Building*, which all remain well below the threshold of 20%. Even other important SEs, such as *Critique* and *Explanation of research* are observed only in less than a third of students. Moreover, only 34% of the students show the *Awareness of knowledge gained* SE. It is important to note how such percentages definitely change when the instructors elicit their scientific inquiry. All the percentages of SEs recorded during the activation phase of the structured inquiry (elicited inquiry) show a significant increase, bringing the *Awareness of knowledge gained* percentage up to 82% of students.

Table 1. Percentage of students showing Speech Events (SE) during the performance of the Franck-Hertz experiment.

Speech events (SE)	Percentage of students showing SE during the
--------------------	--

	performance of the Franck-Hertz experiment	
	Traditional Structured Inquiry	Structured Inquiry with activation
Critique	27%	75%
Elicitation of critique	13%	54%
Awareness of knowledge gained	34%	82%
Contextualization of research	17%	63%
Explanation of research	27%	67%
Negotiation	12%	54%
Consensus Building	18%	68%

Gesture analysis

All the activities of the students engaged into the inquiry-driven Franck-Hertz experiment were videotaped in order to gather information about their attitudes and feelings from their posture and movements. In some cases, this kind of analysis often provides a unique view of students' mental representations of concepts, opening a window on their way of thinking [17]. This may happen, in particular, when the students are not engaged into an active construction of learning, they are "forced" to listen and cannot express immediately all their doubts or questions, such as in a structured inquiry-based case of instruction.

In the following, we show a comparison between the students' gestures observed during the first part of their inquiry-based learning experience, i.e. the strictly *structured inquiry*, with those recorded during the *elicited inquiry* phase of exploration. In Figure 3 we show a picture taken during the phase of structured inquiry without activation, where many arm-cross events are observed. Usually this kind of posture is a self-comforting posture used mostly unconsciously to alleviate nervous tension and isolate ourselves. In special situations this position might also suggest self-importance or disagreement. Moreover, some students remain focused on the experimental setup, looking at the data appearing on the oscilloscope screen, while others look away, probably lowering the attention towards the experimental results (Figure 3).



Figure 3. A sample picture taken during the traditional structured inquiry.



Figure 4. Pictures taken during the phase of Elicited Inquiry.

The stimulating discussions between students and instructors about the experimental findings coming from the Frank-Hertz experiment produced a specific effect of activation of the inquiry process. In fact, the students showed many more postures associated to reasoning efforts (Figure 4), demonstrating a clear increase into their involvement and an active participation into the process of knowledge construction. Moreover, during this phase the students also showed many gestures explicative of QM concepts (Figure 4). In summary, we have found that an *activated* participation to this structured inquiry-based learning experience favored the building of cognitive links among student theoretical perceptions of QM and their vision of quantum phenomena, within an everyday context of knowledge.

5. Conclusions

Student interest in QM can be increased through laboratory experiments that illustrate the inadequacy of classical physics for understanding microscopic phenomena. Quantization is the fundamental concept necessary for understanding the development of QM and the Franck and Hertz experiment reveals that quantized electronic energy levels really exist. This experiment gives the students the opportunity to appreciate the concept of quantization and the field of electron spectroscopy. In addition, it allows the students to follow the historical lines of a milestone experiment in the development of the quantum theory. However, an effective understanding of QM concepts can be achieved only within a process of active learning typical of inquiry.

An inquiry driven experience of an experiment confirming the existence of the atomic quantized states could make the study of QM concepts more meaningful. Unfortunately, the process of scientific inquiry is spontaneously activated mainly for people experiencing everyday phenomena. In students going to understand phenomena not directly related to their everyday experience, such as when approaching the study of QM, *the inquiry process must be explicitly activated*.

In this study, an *elicited inquiry*-based learning path has been experienced by a sample of engineering undergraduates who already attended university-level courses on quantum physics concepts. Despite their previous instruction, students initially persisted to hold a vision of quantum science basically in terms of a mathematical framework and did not actively engage into a traditional structured inquiry. Our results show that scientific inquiry could not always be spontaneously performed by students involved in QM studies. Nevertheless, we have found that a stimulated activation of the inquiry process may constitute an efficient teaching/learning approach both to effectively engage students into active learning and, at the same time, to clarify important experimental and technological aspects of QM. Video analysis clearly demonstrated a great participation and motivation to learn, both in terms of useful discussions and scientifically relevant questions. The reasoning effort asked to the students to perform this learning experience successfully reinforced their understanding of the QM fundamental concepts. This experience definitely favored the building of cognitive links among student theoretical perceptions of QM and their vision of quantum phenomena, within an everyday context of knowledge. We believe that an explicitly activated structured-

inquiry approach could support effectively the teaching of QM to students who already have a solid background of conceptual knowledge. Under these terms, the integration of curricular instruction with teaching/learning strategies based on explicitly activated inquiry approaches seems a viable solution to improve the overall understanding of quantum physics.

References

- Rocard M, Csermely P, Jorde D, Lenzen D, Walberg-Henriksson H, Hemmo V 2007 *Science Education Now: A renewed Pedagogy for the Future of Europe* (EU Research Report ISSN 1018-5593)
- Borrego M and Bernhard J 2011 *The emergence of engineering education research as an international connected field of inquiry* J. Eng. Educ. **100** 14
- National Academy of Engineering (NAE) 2012 *Frontiers of Engineering 2011* (Washington DC: The National Academies Press)
- National Academy of Engineering (NAE) 2004 *The Engineer of 2020: Visions of Engineering in the New Century* (Washington DC: The National Academies Press)
- Llewellyn D 2002 *Inquiry Within: Implementing Inquiry-based Science Standards* (Thousand Oaks, Ca: Corwin Press Inc.)
- National Research Council (NRC) 2000 *Inquiry and the National Science Education Standards: A Guide for Teaching and Learning* (Washington DC: The National Academies Press)
- Schwab J J 1962 *The teaching of science as inquiry* In J J Schwab & P F Brandwein (Eds.) *The teaching of science* 3–103 (Cambridge, MA: Harvard University Press)
- Herron M D 1971 *The nature of scientific enquiry* School Review 79 171–212
- Banchi H & Bell R 2008 *The Many Levels of Inquiry* Science and Children 46 26-29
- Schwartz R S, Lederman N G, Crawford B A 2004 *Developing Views of Nature of Science in an Authentic Context: An Explicit Approach to Bridging the Gap Between Nature of Science and Scientific Inquiry* Sci. Educ. 88 610-645
- Flick L, Lederman N G 2006 *Scientific Inquiry and Nature of Science Contemporary Trends and Issues in Science Education* (Flick L, Lederman N G, Eds.) 25 ISBN 978-1-4020-2671-3
- Capps D K, Crawford B A 2012 *Inquiry-Based Instruction and Teaching About Nature of Science: Are They Happening?* J. Sci. Teach. Ed. DOI 10.1007/s10972-012-9314-z
- Berg C A R, Bergendahl V C B, Lundberg B K S 2003 *Benefiting from an open-ended experiment? A comparison of attitudes to, and outcomes of, an expository versus an open-inquiry version of the same experiment* Int. J. Sci. Educ. 25 351-372
- Quintana C, Zhang X, Krajcik J 2005 *A framework for supporting meta cognitive aspects of on-line inquiry through software-based scaffolding* Educ. Psychol. 40 235-244
- Winsor D 2001 *Learning to Do Knowledge Work in Systems of Distributed Cognition* Journal of Business and Technical Communication **15** 5
- Donath L, Spray R, Thompson N S, Alford E M, Craig N, Matthews M A 2005 *Characterizing Discourse Among Undergraduate Researchers in an Inquiry-Based Community of Practice* J. Engin. Educ. **94** 403
- Scherr R E 2008 *Gesture analysis for physics education researchers* Phys. Rev. ST Phys. Educ. Res. **4** 010101

Affiliation and address information

Dominique Persano Adorno
 Physics Education Research Group
 Department of Physics and Chemistry
 University of Palermo
 Viale delle Scienze, ed. 18
 90128 Palermo - Italy
 e-mail: dominique.persanoadorno@unipa.it

Physical Modelling: a Different Approach to Teach Non-Physics Majors.

Estela Margarita Puente Leos, Marcos Ley Koo

Facultad de Ciencias, Universidad Nacional Autónoma de México

Abstract

This work describes how to build a simple qualitative physical model of the electric conduction in the heart, which may help students, interested on health sciences, to understand relationships among physical phenomena and physiological processes. Additionally, it shows the importance of learning physical concepts and analogies, such as electrical resistance, heat conduction, which leads to the introduction of the Seebeck, Peltier and Joule effects, as well as Ohm and Fourier laws. This experiment introduces students to the art of modelling and by the way they have enjoyable learning experience.

Keywords

Laboratory activities. Teaching strategies. Physical modelling. Heat conduction. Electrical circuits.

1. Introduction

This work is an attempt to introduce students to the art of modelling, specially due to the importance of modelling the electrical activity of the heart. The model allows students to visualize the electric propagation in the heart. For this visualization, we consider the continuum-base model of cardiac activity from cell level to body surface. Such model treats the medium, in this case the heart of some part of thereof, as continuous, rather than being made up of discrete atoms and molecules.

As Physical Modelling is the process of combining quantitative data with qualitative understanding to produce an explanatory and predictive tool; we hope that, with this work, students gain a better understanding and appreciation of how physical modelling can be used to represent and simulate the various processes that constitute the heart beat. Although, we are aware that modelling electrical activity in myocardial tissue is a more complex problem, we think is a good approach to initiate modelling. This work is aimed to non-physics major students, but as well it is suitable for first year undergraduate physics and applied mathematics students.

During 2013 summer, at the Facultad de Ciencias of the Universidad Nacional Autónoma de México, a group of pre-college students who were interested on study a non-physics mayor, worked with this visualization and they enjoyed the idea of finding a relation between physics and medicine.

2. Brief physiological description of the heart

In any physical modelling problem it is vitally important to have a good understanding of the physical problem and, for that reason, a brief background anatomy and physiology is covered to provide a suitable context for understanding the detailed modelling that is presented herein; in particular, we will briefly describe the electrical activity of the heart from a macroscopic point of view.

The heart is an organ with complex structure, is a muscular organ that acts as a variable speed biomechanical pump. Electrical impulse originating in specialized cells, caused by the flow of ions across the outer cell membrane, give rise to a self-perpetuating excitation wave that spreads through the entire heart. This excitation coordinates the contraction of cardiac cells pumping blood to the body and to the heart itself. A consequence of normal activation is the coordination and cooperation of all cardiac fibers so that the total heart contracts and pumps efficiently.

The electrical signal that controls the mechanical activity of the heart starts at the right atria, at the sinus node (SA node). The SA nodal cells are self-excitatory, pacemaker cells. They generate an electrical activity at the rate of about 70 per minute. From the sinus node, activation propagates throughout the atria, travels down a specialized conduction system: the atrioventricular node (AV node) which is located at the boundary between the atria and ventricles; the bundle of His and the Purkinje fibers that diverge to the inner sides of the ventricular walls. At the cellular level, the electrical signal is due to a variation of the cellular membrane potential, called the action potential.

3. Concepts of physics present in the physical model

Once the physiological processes have been briefly described, it is convenient to introduce the basic concepts of physics, and their analogies, which are used in the attempt to model some process in the heart.

A material which allows the flow of an electric current is called an electrical conductor; it is widely accepted that such a current is the manifestation of the movement of electric charges (Δq), over a time (Δt), when the ends of the conductor, of length L , are subject to an electric force per unit charge (E). The relation between the electric current I , ($I = \Delta q / \Delta t$), and the electric potential or voltage V , ($V = EL$), is governed by the so-called Ohm's Law, which states that V is proportional to I , $V = RI$. The proportionality constant is a property of the conductor, which depends inversely on the electric conductivity, the geometry and the temperature; both are included in the so-called electric resistance R , which represents the opposition of the material to the flow. As a result, some of the electric energy will be transformed into heat through a process known as Joule heating.

There are, also materials, which allow the flow of heat and are called heat conductors. There are conceptual, as well as mathematical similarities among electric and heat conductors; however, in heat conductors, the flow is the manifestation of the movement of electrically neutral particles, (atoms, molecules,...) composing the material, which will transfer energy (ΔQ , heat), over a time Δt , when the ends of the conductor, of length L , are subject to a temperature difference ΔT . The relation between the heat current J , ($J = \Delta Q / \Delta t$), and the "thermal driving force" W , ($W = \Delta T / L$), according to Fourier's Law, is that J is proportional to W , usually written as $J = KW$. The proportionality constant K is a property of the conductor and depends on the thermal conductivity, the geometry and the temperature.

If two different conductors are considered then other effects will appear, since electric and thermal conductivities are intrinsic properties of the conductors. In order to describe the so-called thermoelectric Seebeck and Peltier effects, let A and B be such conductors, join one end of A with one of B , do the same with the two free ends, split open either conductor A or B ; such array leads to two AB junctions and two free ends.

The Seebeck effect is observed when the AB junctions are placed in contact with two objects at different temperature, each junction per object, then there will be a voltage between the free ends, the voltage changes with the temperature of the objects; such effect is the basis for temperature measurements using thermocouples.

On the other hand, the Peltier effect is observed when voltage is applied to the free ends, there will be a temperature difference between the junctions AB , the temperature difference changes with the applied voltage; such effect is used for heating or cooling processes, or to build point heat sources.

The temperature distribution, produced by a point heat source, may be obtained by solving Fourier's equation; however, instead of seeking the solution, the distribution may be visualized through a liquid crystal sheet. The orientation of the macromolecules of the liquid crystal is sensitive to temperature differences so that reflected white light will have missing colors.

The molecules in a liquid crystal sheet are called cholesteric liquid crystals. The molecules are rod-shaped. The rods form layers in the liquid crystal, the rods in adjacent layers running in a slightly different direction from those in the layer above or below. From one layer to the next, the rods form a spiral staircase-like structure that rises through some distance before the molecules twist around parallel to their original direction. When this distance equals half-a-wavelength of red light, the liquid crystal will reflect red light. When the distance is shorter, matching half a wavelength of blue light, the crystal will reflect blue light.

When the liquid crystal warms up the layers spread apart slightly, but, in addition, each layer of rods rotates a little more relative to those below it. This means it takes fewer layers and, therefore, a shorter distance between layers of parallel rods. So when the temperature increases, the spacing between layers, in which the rods are parallel, decreases. Liquid crystals possess the mechanical properties of a liquid, but have the optical properties of a single crystal.

In heat flow by conduction, thermal energy, represented by the vibration of molecules, moves from one place to another place. The vibrating molecules collide with their neighbors setting them into motion. A high temperature pulse will naturally propagate into a low temperature region as the vibrational energy spreads, so that a heat pulse will spread rapidly. Students can observe how the temperature changes as heat flows by conduction through the sheet.

When students held a liquid crystal sheet over the hand and observe it as it warms up, they notice that it starts out black, then becomes red, yellow, green, blue then black once again, as shown in Figure 1.

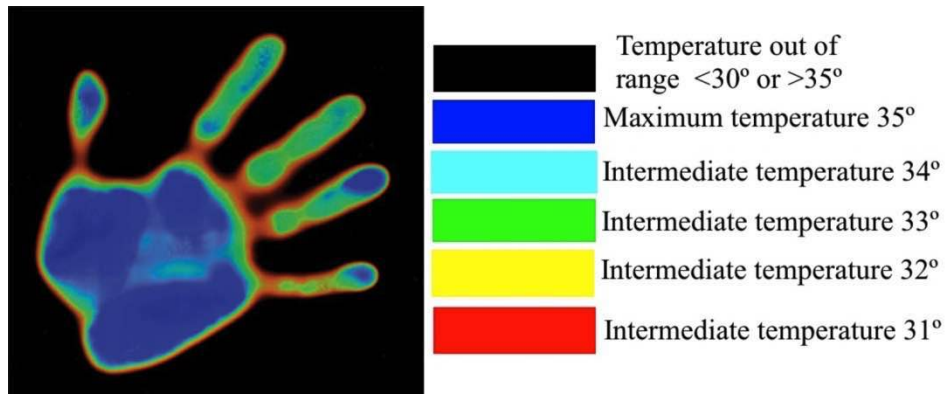

Figure 1. Response to warming of a Reversible Liquid Crystal Mylar Sheet

Due to the fast response time, the students realized that the sheet provided a quick visual readout of the temperature distribution, and suggested its use in Laboratory. These sheets consist of a series of temperature-sensitive elements containing Microencapsulated Thermochromic Liquid Crystal (TLC) coated on a black backing. Each element changes color distinctly as its rated temperature is reached, passing through the colors of the spectrum in sequence from red to green to blue before turning black at a higher temperature. In this case, we use a sheet of sensitive range from 30°C to 35°C , and it can be used over and over again.

4. Procedure

Myocardial cells can spontaneously depolarize, a process called automaticity. In order to model this process, we use a Type K (CHROMEKA®-ALOMEGA®) surface thermocouple (Figure 2); which have a response Time in Millisecond and a very Low Thermal Inertia, making them ideal for a fast heating of liquid crystal sheets and, thus, providing a quick visual response.

However, in order to do so, the relation between its temperature and the voltage, in its free ends (Seebeck effect), must be known. Otherwise, it may be possible that the temperature range of the LC is missed when voltage is applied to the thermocouple and used as a point heat source (Peltier effect); as a result, the students learned to calibrate a thermocouple.

The voltage, across the free ends of the thermocouple, is of the order of millivolts and, thus, with the aid of a resistor (Ohm's Law) and an AC/DC adapter, the thermocouple may be used as a point heat source. At this step, students used Ohm's Law to calculate the value of the resistor, which coupled to the thermocouple was placed under a liquid crystal sheet and, its response to warming, used to visualize the electrical changes of a cell, relying on the analogy between electric and heat flows (Ohm's and Fourier's Laws).



Figure 2. Type K (CHROMEKA®-ALOMEGA®), surface thermocouple

At the beginning, the sheet is black and will change its color depending on the temperature of the thermocouple. As heat flows from the thermocouple to the LC sheet, the temperature of the sheet will increase and it will change color from black to red, to yellow, green, blue, and finally back to black again, as shown in Figure 3

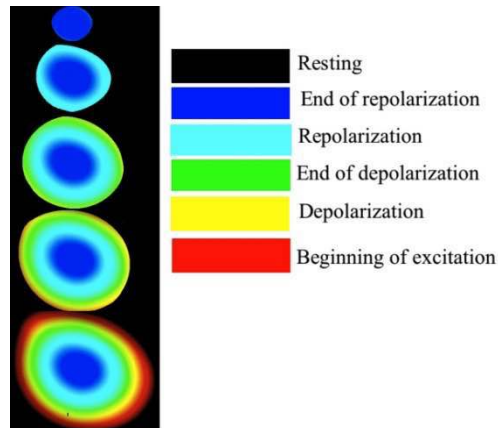

Figure 3. Thermocouple placed under a liquid crystal sheet. Its response to warming can be used to visualize the electrical changes of the cell.

An important property of a single heart cell is its sensibility to electrical stimuli from neighboring cells. A distinction between cardiac and skeletal muscle tissue is that in the former, activation can propagate from one cell to another in any direction. An adequate stimulus will initiate a response, which is equivalent to a time-varying source of voltage, from an electrical standpoint. As a result, a cardiac cell participates in the propagation of the electrical impulse because its own activity is capable of exciting its neighboring cells. Currents generated by an active cell produce a “Depolarization Wave” that goes from cell to cell through the entire heart.

The sequence, in which the wave of depolarization spreads across the myocardium, increases pumping efficiency of the heart. The SA node, at tight atrium initiates depolarization, this impulse spreads cell by cell through the atria. The contraction of the atria propels blood in the atria toward the AV valves. Depolarization spreads by the cardiac specialized conduction system all over the heart in order to obtain a good contraction of the ventricular muscle and propel blood outside the heart.



Figure 4. Type K (CHROMEGA ®-ALOMEGA ®) thermocouples setup simulating the cardiac conduction system

Thus, we can consider cardiac muscle as composed of low-resistance connected individual cells that can be modelled by an electric circuit of resistances, whose spatial distribution is determined by the conditions under modelling, as in Figure 4.

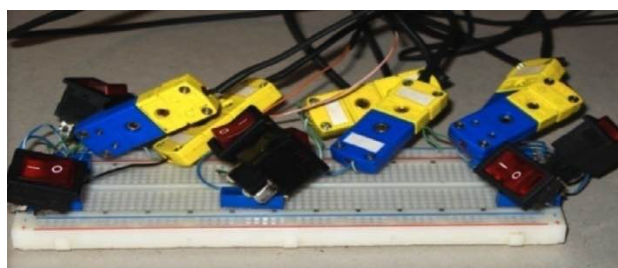

Figure 5. Circuit used to heat up thermocouples

However, as before, the thermocouples voltages, as function of temperatures, must be first determined to add the appropriate resistor, so as to insure the activation of the LC sheet at the right temperature; a trimpot (variable resistance), for each thermocouple, was added in this work. Additionally, a set of switches was introduced so that the corresponding thermocouple-trimpot combination, as shown in Figure 5, was manually activated at the proper time, determined by the array of the thermocouples, once the circuit was connected to an AC/DC adapter.

Thus, assuming that the propagation of an electric stimulation is similar to heat conduction, the students can visualize it by color changes produced by temperature changes in a Reversible Liquid Crystal (LC) Mylar Sheet, as shown in Figure 6. Here, again we relied on Ohm's and Fourier's laws.

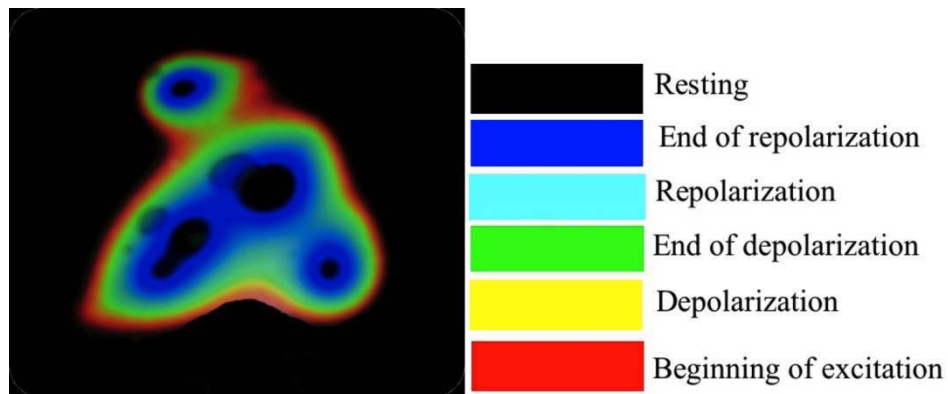

Figure 6. Reversible Liquid Crystal Mylar Sheet modelling bidimensional electrical propagation in cardiac tissue

Therefore, various conditions of cardiac cells may be modelled by changes in the resistances, the temperature variation rate, and different cells are modelled through changes in the time of heating, the excitation frequencies variations.

To control the current and so the temperature, each thermocouple must be connected to a trimpot; in this way, different temperature change rates may be achieved and, thus, different cells of the cardiac electric conduction system are simulated.

5. Conclusion

This experiment introduced pre-college and non-physics majors students to the art of modelling and allows them to learn several physical phenomena, as well as its applications to other disciplines. In particular, cardiac electric excitation was simulated in an easy way and visualized, in a liquid crystal sheet, through the analogy between electric propagation and heat conduction. The students were excited to actually see that physical concepts they learned were useful to realize the physical model, successfully; as a result, this experiment has been proposed to be part of a basic experiments to be performed by biomedical physics students, at our University.

Various conditions of cardiac cells may be modelled changing the circuit parameters: changing resistance, different cells can be modelled. Turning on and off switches at different times, different excitation frequencies can be modelled as well, as the refractory period of different cells.

Most cardiac impulse conduction models consider an action potential wave front, and assume a continuously uniform intracellular resistivity in the direction of propagation. Modelling the wave front can help students to understand this phenomenon and to relate different physical concepts.

Modelling in a Physics course provides stronger conceptual connections between different subjects and it becomes a nicer experience, disappearing the traditional disconnection that exists from physics to health sciences. Modelling in different subjects can help to emphasize the interplay of concepts in science.

References

- Chen, M., Rosendahl L., Bach, I., Condra, T. and Pedersen, (2007). J. Irreversible transfer processes of thermoelectric generators. *American Journal of Physics* **75**, 815.
- Hayn, C. H. Liquid crystal displays. (1981). *The Physics Teacher* **19**, 256
- Carroll, R.G. (2007) *Elsevier's Integrated Physiology*. Mosby Elsevier. Philadelphia, USA.

Affiliation and address information

Estela Margarita Puente Leos and Marcos Ley Koo
Laboratorio de Acústica,
Departamento de Física,
Facultad de Ciencias, Universidad Nacional Autónoma de México,
Circuito Exterior, Ciudad Universitaria, 04510,
México, D.F., México
e-mail: mpl@ciencias.unam.mx
and mlk@ciencias.unam.mx

The Nature of Students' Reasoning Processes in Tasks Involving the Concept of Angular Acceleration

Graham Rankin

Kwantlen Polytechnic University, Canada

Abstract

First and second year university physics students' reasoning as they address several tasks involving the concept of angular acceleration were explored in a variety of task settings. These reasoning processes are described in terms of associations made by students to the words and images that were evoked during a particular task setting.

Keywords

angular acceleration, conceptions, understanding, reasoning

1. Introduction

This study of the concept of angular acceleration is an extension of Reif's and Allen's investigation (1992) of student cognitive difficulties in their interpretation of the concept of acceleration and of the work by Rankin (2013) in his study of students' understanding of angular speed.

Reif viewed the knowledge of being able to find the acceleration of a particle moving in an arbitrary path as being procedural knowledge. However, he also observed that student novices in their reasoning about kinematic quantities as acceleration rarely use any form of procedural knowledge, instead relying heavily on various pieces of knowledge.

These knowledge pieces, often lacking the constraint or validity conditions for which they are true, as for example a particle has zero velocity then its acceleration must always be zero, is echoed in the work of DiSessa (1988).

2. The Study

Fifteen volunteers, comprising first and second year university students, all of whom had prior instruction about the concept of angular acceleration were interviewed for this study in a variety of task settings. The nature of the reasoning processes employed by these students as they answered questions about an object moving in different paths are described and categorized in terms of mental associations with the words, images, and context experienced by the students during the task setting.

Each task for ease of reference was named after the path the object moved in. In two of the tasks, a description of the motion of the object was illustrated by a diagram and a verbal explanation; the other tasks involved the motion of real objects with a verbal explanation.

The tasks were, the "oval path" task in which a toy train traveled around an oval track at a constant speed, the "semicircular path" task in which ping-pong balls were made to roll and accelerate along semicircular paths of differing radii of curvature, and the "irregular path" task in which a diagram depicted the motion of an object moving in an irregularly shaped path at a constant speed.

3. Methodological framework

Categories of reasoning were generated to describe the ways in which students thought about the concept of angular acceleration during a task. These categories of reasoning are based on Marton & Booth's (1997) approach for analyzing qualitative data which was developed from Marton's early work on phenomenography (1981). The process of forming categories however, is never complete, we can never claim that there are no other ways of seeing or thinking about a phenomenon than the ones we know of (Marton, 2006).

In the tasks presented to the students, the words and images used in the context of a particular task were found to influence the way in which a student responded to questions about angular acceleration. These observations are consistent with a view that cognition is itself situated within a context. And what is recalled from ones memory is dependent in part on the context and not just the knowledge or concepts held by an individual.

4. Students' reasoning about angular acceleration

An analysis of student responses during the interviews resulted in the construction of *categories of reasoning* which were represented by three forms of associations. These associations, are conjectured to act as a linkage in a student's memory during the task activity to either the words *angular* or *acceleration*, or to an association with an *equation* for angular acceleration, or to some aspect of the *context* of the task setting. These forms of associations, each to be described with a few illustrative examples are respectively referred to as: **word**, **symbolic**, and **contextual** associations.

5. Word association

Word association is a simple or complex association of words which are evoked in the student's memory with some aspect of the words "angular acceleration". The words associated by students were inferred from their verbal responses. For example, a student might state that an object moving in an oval path at a constant speed does not have an angular acceleration because it is never increasing its speed. While the student may not explicitly use the word acceleration (by itself), it was nevertheless hypothesized that a mental reference to the word was made by the student, as such a reference, an association, provides a coherent explanation of what was said by the student.

A student may go through a series of mental steps prior to articulating a response to a question about the angular acceleration of an object. This may at times be represented by a sequence of inferred associations. Such a sequential order of steps is illustrated below by using an arrow \rightarrow to indicate an association (in this case a word association) with the non-verbalized association in parentheses.

$$\text{angular acceleration} \rightarrow (\text{acceleration}) \rightarrow \text{change in speed (or velocity)}$$

$$\alpha \rightarrow (a) \rightarrow \Delta s$$

The following dialogues illustrate word associations.

I: Does the train ever have an angular acceleration? [I: interviewer]

K: (pause) No, because during the track you are never increasing the speed.

Or,

G:..it is clear to me that it doesn't have an angular acceleration.

I: And why?

G: It is just not--it is not like increasing--going around faster and faster.

$$\text{Or, } \alpha \rightarrow (a) \rightarrow \Delta v$$

I: ..does that train have an angular acceleration?

S: Yeah, because it is a vector--magnitude and direction. There is a change in direction.

6. Symbolic association

A student may associate angular acceleration with its symbolic form as expressed in a formula, hence the description *symbolic* association. The following excerpt of a student dialogue during the elliptical path task illustrates this form of association.

$$\text{formula} \rightarrow a/r \text{ (semi-circular path)}$$

I: How about angular acceleration..

J: Yeah, because alpha is a over r so if there is a change in acceleration there has to be..a change in angular acceleration.

Or,

I: Let's talk about angular acceleration...

L: I think about the angular speed and the radius and formula.

I: Which is?

L: Angular acceleration equal(s) ω over r

Another form of association which characterizes the responses of some students is illustrated by *contextual* association. This form of association is characterized by the student relating an event, experience or some piece of knowledge with some aspect of the context of the task setting.

7. Contextual association

A feature of the *context* of the task setting serves to evoke an association in the student's mind with some prior experience, belief or knowledge. An object moving in a circular or curved path serves as a cue for angular acceleration, as illustrated in the first example.

$\alpha \rightarrow$ circular motion (oval path)

I: Does the train have an angular acceleration? [I: interviewer]

L:.. I think it does have angular acceleration because it is moving in a circular motion (on some part of the track)...

$\alpha \rightarrow$ (circular motion) \rightarrow force (various paths)

K: ..to talk about the ball having an angular acceleration it implies a **force** being acted upon it and there is nothing pushing the object around (the irregular path) at a constant speed.

M: Always has (an angular acceleration), because it is keeping within the course of the (semi-circular) track in order to do that it must have a **force** to allow the ball to stay in.

[Later in response to a toy train moving in oval track]

M: I think the key factor for angular acceleration is that the train feels--

I: By the train feels, you would be referring to what?

M: Let's say it wasn't a train, let's say it was another person and I was to run around the track..I would always have to make my left foot-like-put more force on my left foot to turn right.

This response is not unlike what Clement (1987) noted in his study of the use of analogies in mechanics in which approximately half of the analogies (made) were personal analogies referring to some sort of body action.

Another example of contextual association was to coriolis force.

$\alpha \rightarrow$ (circular motion) \rightarrow coriolis force (semi-circular path)

I: Does the ball have an angular acceleration?

L: Yes.

I: And, because?

L: Because, again its moving in circular motion and because of the coriolis force...

[Later when probed further as to this explanation]

L: How I understand it--when an object is on a frame that's rotating--the ball on the table and the table is on the earth and well the frame would be say the earth--the earth is rotating, so that causes a coriolis force.

The ball's motion on what is perceived to be a rotating table was seen by the student as suggesting that the ball had an angular acceleration because of the coriolis force. While this may be an inappropriate analogy it does nevertheless represent a form (an example) of contextual association.

It was however observed that some students exhibited more than one form of association in their responses. For example, circular motion \rightarrow (acceleration) \rightarrow angular acceleration (a word association) and a symbolic association, $\alpha \rightarrow v^2/r$ even though such a student may appear to be thinking about centripetal acceleration instead.

8. Discussion

Student responses to questioning about the angular acceleration of an object have been characterized in terms of three types of associations: word, symbolic and contextual. A student may use several forms of reasoning as so described even though on a particular occasion only one form of reasoning may be exhibited.

Our understanding of a situation means being reminded of the thing in memory that is closest to the experience we are currently having (Schank & Seifert, 1985). Such a characterization of reasoning is consistent with the view that how a person acts and responds in a situation is inherently contextualized. To this end, being reminded of something, whether or not it occurs by words as in *word* association, by symbols as in *symbolic* association, or by surface similarities as in *contextual* situation, with some aspect of a problem situation is thought to be an important way in which we frame, think about, or understand a problem. The implications for instruction arising from this view of student reasoning suggests that an instructor in physics needs to be aware of how words, symbols and images which appear in physics textbooks or in lectures may impede the development of a student's understanding of the kinematic concept of angular acceleration in a variety of problem contexts or tasks.

Unfortunately such awareness may not lead to appropriate teaching strategies being used even when the problem is well defined and understood. It will be for further research to establish the effectiveness of any such instructional strategies.

References

- Clement, (1987), J. *The use of analogies and anchoring intuitions to remediate misconceptions in mechanics*. Paper presentation, AERA.
- Disessa, A. (1988), *Knowledge in Pieces, Constructivism in the Computer Age*, Forman, G. Pufall, P (ed), Hillsdale, NJ, Lawrence Erlbaum.
- Marton, F. (1981) Phenomenography--Describing conceptions of the world around us, *Instructional Science*, 10 177-200
- Marton, F., & Booth, S. (1997), *Learning and Awareness*, Routledge
- Marton, F., (2006) Sameness and Difference in Transfer, *J. of the Learning Sciences*, 15(4), 499-535
- Rankin, G. (2013). Students' understanding of angular speed, *Proceedings of the International Conference on Physics Education*, ICPE-EPEC Prague, Czech Republic, 206-212
- Reif, F., & Allen, S. (1992). Cognition for Interpreting Scientific Concepts: A Study of Acceleration, *Cognition and Instruction*, 9(1), 1-44
- Schank, R. & Seifert, C. (1985), *Modelling Memory and Learning, How we know*, ed. Shafto, M, Harper & Row, San Francisco

Active Learning of Introductory Optics: A Workshop

David R. Sokoloff

Department of Physics, 1274 University of Oregon, Eugene, Oregon 97403-1274, USA

Abstract

Widespread physics education research has shown that most introductory physics students have difficulty learning essential optics concepts—even in the best of traditional courses, and that a well-designed active learning approach can remedy this. This workshop provided direct experience with methods for promoting active involvement of students in the learning process. The focus was on active learning, *RealTime Physics (RTP)* hands-on lab activities, and *Interactive Lecture Demonstrations (ILD)*—a learning strategy for large (and small) lectures, including the use of special Optics Magic Tricks. Sample materials and instructions on how to do the tricks were distributed. These materials have been used successfully by the author in his introductory college level physics courses, and recently in a series of Active Learning Optics and Photonics (ALOP) workshops in developing countries, sponsored by UNESCO, SPIE and ICTP. Research on the effectiveness of these approaches was also presented.

Keywords

Active learning, introductory physics, optics

1. Introduction

There is considerable evidence that traditional approaches are ineffective in teaching physics concepts, including light and optics concepts [1,2]. A major focus of the work at the University of Oregon and at the Center for Science and Mathematics Teaching (CSMT) at Tufts University has been on the development of active, discovery-based curricula like *RealTime Physics (RTP)* labs [2,3] and *Interactive Lecture Demonstrations (ILDs)* [4,5]. Among the characteristics of these curricula are:

- Use of a learning cycle in which students are challenged to compare predictions—discussed with their peers in small groups—to observations of real experiments.
- Construction of students' knowledge from their own observations. Real observations of the physical world are the authority for knowledge.
- Confronting students with the differences between their observations and their beliefs.
- Observation of results from real experiments in understandable ways—often in real time with the support of computer-based data acquisition tools.
- Encouragement of collaboration and shared learning with peers.
- Laboratory work often used to learn basic concepts.

With the use of the learning cycle and the computer-based data acquisition tools it has been possible to bring about significant changes in the lecture and laboratory learning environments at a large number of universities, colleges and high schools without changing the lecture/laboratory structure of the introductory physics course. For example, in the U.S., nearly 200 physics departments have adopted *RTP* [6], and many others use pre-publication, open-source versions or have adopted the *RTP* approach to develop their own labs. Examples from *RealTime Physics*, *Interactive Lecture Demonstrations* and Optics Magic Tricks—appropriate for an introductory general physics course—are described briefly in this paper.

2. *RealTime Physics: Active Learning Labs (RTP)*

RealTime Physics is a series of lab modules for the introductory physics course that often uses computer-based data acquisition tools to help students develop important physics concepts while acquiring vital laboratory skills [2,3]. Besides data acquisition and analysis, computers are used for basic mathematical modeling, video analysis and some simulations. *RTP* labs use the learning cycle of prediction, observation and comparison. They have been demonstrated to enhance student learning of physics concepts [1,2]. There

are four *RTP* modules, *Module 1: Mechanics*, *Module 2: Heat and Thermodynamics*, *Module 3: Electricity and Magnetism* and *Module 4: Light and Optics* [3]. Each lab includes a pre-lab preparation sheet to help students prepare, and a homework, designed to reinforce critical concepts and skills. A complete teachers' guide is available online for each module.

While technology is used in *RealTime Physics Module 4* to help students measure light intensities, understand the effects of polarization and observe interference and diffraction patterns [7], the example done in the workshop was a low-tech activity on image formation from Lab 3. This activity is inspired by the research of Goldberg et. al [8]. This research shows that after traditional (passive) instruction in a general physics course, the majority of students demonstrate in interviews that they have no understanding of the role of a lens in forming a real image on a screen. It describes how drawing ray diagrams with two or three special rays causes students to fail to recognize that an infinite number of rays can be drawn emanating from each point on the object, and that all of the rays from a single point source that actually are incident on a perfect lens are focused to a corresponding point of the image. To avoid this pitfall, we have students use miniature light bulbs (or LEDs) as two point sources on the object, and a cylindrical lens [9] to view the focusing of the rays clearly in two dimensions.

In Investigation 1, students are asked to tape the light bulbs to the head and foot of the object arrow on the lab sheet, in front of the lens. Figure 1 shows the setup, and Figure 2 shows what appears when both bulbs are illuminated. The two image points can be recognized as the points to which light from each of the bulbs is focused. The students are then asked to predict what will happen when various changes are made, for example, if half of the lens is blocked with a card. (Research shows that the majority of students predict that either half or the entire image disappears [8].) Figure 3 shows what actually happens. Light from both point sources is still focused to the same two image points, but now only half as much light reaches these points. Therefore, the image is the same in every way as in Figure 2, except that it is dimmer. In contrast, Figure 4 shows what happens when half of the object is blocked by the card; there can be no image points for object point sources that are blocked.

Figure 5 shows an excerpt from *RealTime Physics Module 4*, Lab 3 to illustrate what the activity looks like. In other activities, students are asked to explore what happens when the lens is moved further away or closer to the object, and when the lens is removed.

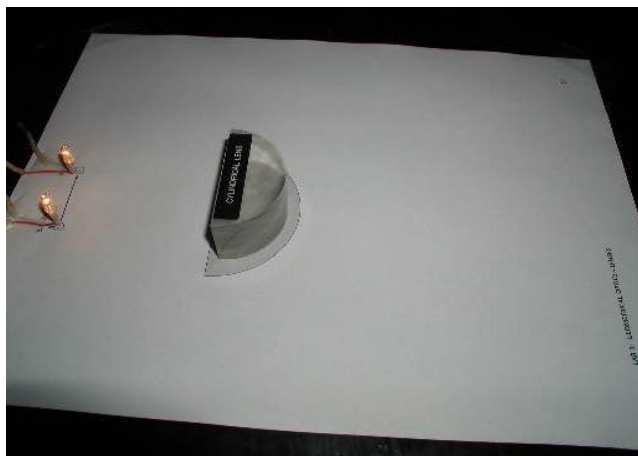

Figure 1. Setup of two miniature light bulbs and a cylindrical lens, used to explore image formation.

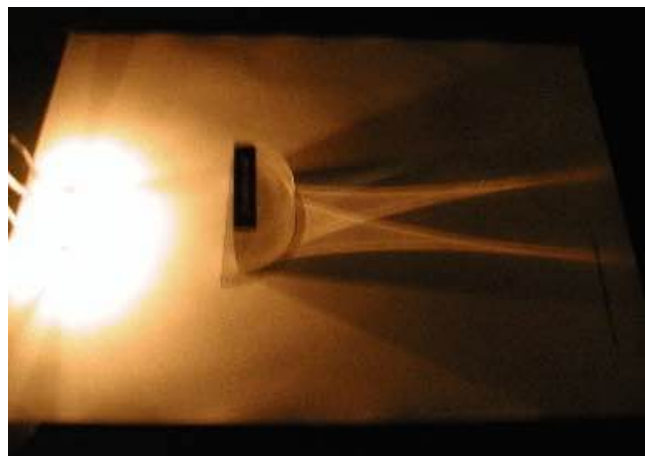

Figure 2. The same setup as in Figure 1 with the two bulbs illuminated.

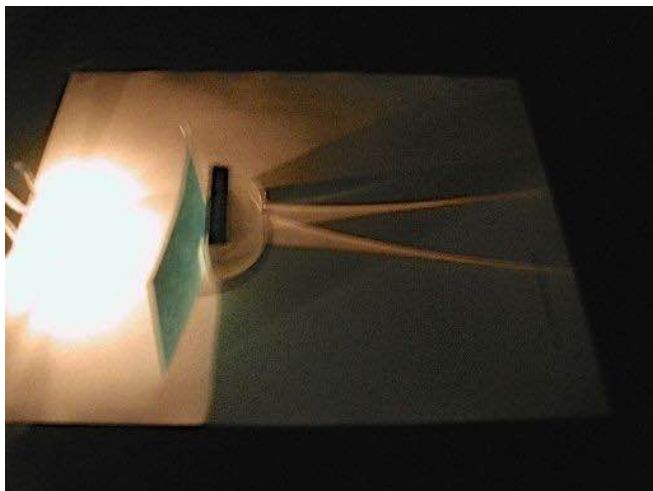

Figure 3. The same setup as in Figure 2, but with half of the lens blocked by a card.

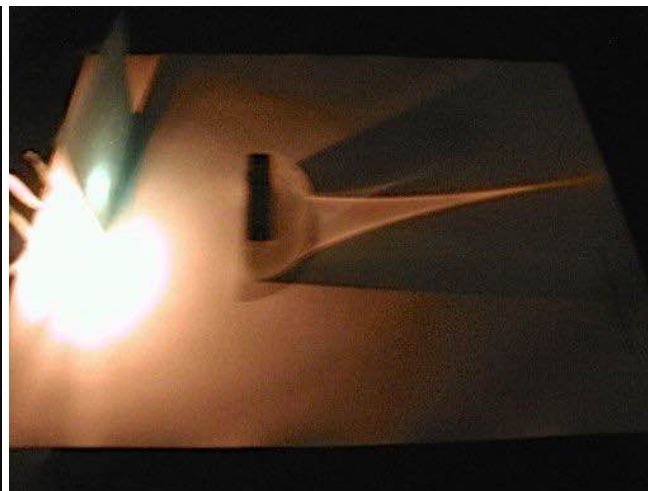

Figure 4. The same setup as in Figure 2, but with one of the bulbs blocked with a card.

Prediction 1-3: Suppose that you covered half of the side of the lens facing the arrow with a card, i.e., covered the top half of the lens as seen in the diagram above. How would the image be changed? Would the whole image of the arrow still be formed?

10. Move the lens back on the outline. Block the top half of the lens (as seen in the diagram above) with a card.

Question 1-9: Carefully describe what happens to the image. Explain your observations based on what happens to rays from each of the bulbs that hit the unblocked half of the lens.

Figure 5. Excerpt from *RealTime Physics Module 4*, Lab 3 showing the activity illustrated in Figure 3.

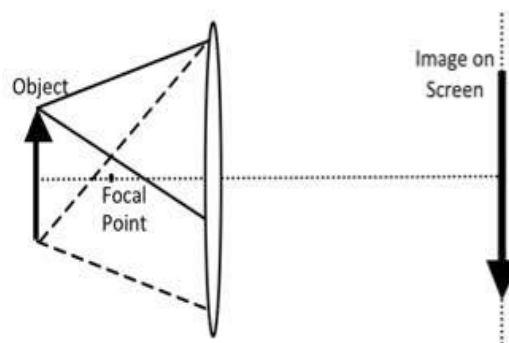

Figure 6. Question from the *Light and Optics Conceptual Evaluation* in which students are asked to continue the four rays to illustrate how the image is formed on the screen.

Do students learn optics concepts from these *RTP* activities on image formation? Here we report on assessments of learning for students who have done these lab activities. Students in the algebra-trigonometry-based general physics course at the University of Oregon had only a 20% normalized learning gain on our physics education research-based *Light and Optics Conceptual Evaluation (LOCE)* [10] after all traditional instruction on image formation. After they completed these image formation lab activities, the students' learning gain from the pre-test was 90%. In addition, the last question on the *LOCE* shows the real image of an arrow formed by a lens, with two (non-principal) rays from the bottom of the arrow and two (non-principal) rays from the top of the arrow drawn incident on the lens. (See Figure 6). Students are asked to continue these four rays through the lens to illustrate how the image is formed by the lens. This task is easy if one understands the function of a perfect lens. While after traditional instruction, only 33% were able to continue these rays correctly, after experiencing the *RTP* image formation activities, 76% could do so.

3. Interactive Lecture Demonstrations (ILDs)

Since the majority of introductory physics students spend most of their time in a lecture class—and often a large one—setting up an active learning environment in lecture is another important pedagogical challenge. *Interactive Lecture Demonstrations (ILDs)* address this need. *ILDs* [4,5] are designed to enhance conceptual learning in large (and small) lectures. Real physics demonstrations are described and shown to students (without displaying the results). The students then make predictions about the outcomes on a Prediction Sheet, and collaborate with fellow students by discussing their predictions in small groups. Students then observe the results of the live demonstration (often with data collected and graphs displayed in real-time

using computer-based data acquisition), compare these results with their predictions, and attempt to explain the observed phenomena. Besides data acquisition and analysis, in some *ILDs*, computers are also used for interactive video analysis.

Table I summarizes the eight step *ILD* procedure incorporating the learning cycle of prediction, observation and comparison. This procedure is followed for each of the basic, single concept demonstrations in an *ILD* sequence.

Table 1. The eight-step *ILD* procedure.

1. The instructor describes the demonstration and does it for the class without measurements.
2. The students record their individual predictions on a Prediction Sheet, that will be collected, and that can be identified by each student's name written at the top. (The students are assured that these predictions will not be graded, although some course credit is usually awarded for attendance and participation at these *ILD* sessions.)
3. The students engage in small group discussions with their one or two nearest neighbors.
4. The instructor elicits common student predictions from the whole class.
5. The students record their final predictions on their Prediction Sheets.
6. The instructor carries out the demonstration with measurements displayed.
7. A few students describe the results and discuss them in the context of the demonstration. Students may fill out a Results Sheet, identical to the Prediction Sheet, that they may take home with them for further study.
8. The class and instructor discuss analogous physical situation(s) with different "surface" features. (That is, different physical situation(s) based on the same concept(s).)

ILDs have been demonstrated to enhance student learning of physics concepts [1,5]. Complete materials—including student sheets and teachers' guides—are available for most introductory physics topics [4].

Figure 7 shows excerpts from the Prediction Sheet for the sequence of *ILDs* called "Polarized Light." The demonstrations in these *ILDs* can be carried out with sheets of Polaroid and an overhead or other projector. They can also be done more quantitatively using the apparatus shown in Figure 8. It consists of an analyzer fabricated from a Polaroid disk mounted on a precision rotary motion sensor [11] with a light sensor [12] mounted behind it. Using a light source consisting of a flashlight with a piece of Polaroid mounted on its lens, the graph in Figure 9 is traced out as the analyzer is rotated through one full rotation. The data may be modeled as a function of angle. Figure 9 also shows a graph of $\text{Acos}^2\theta$, that has been adjusted both in amplitude and phase to match the collected data very well. (Malus' Law.)

Hand in this sheet Name _____

**INTERACTIVE LECTURE DEMONSTRATIONS
PREDICTION SHEET—POLARIZED LIGHT**

Directions: This sheet will be collected. Write your name at the top to record your presence and participation in these demonstrations. Follow your instructor's directions. You may write whatever you wish on the attached Results Sheet and take it with you.

Demonstration 1: Consider a vertical object approaching a picket fence that is tilted by some angle θ with respect to that object. Will this object pass through the fence to the other side?

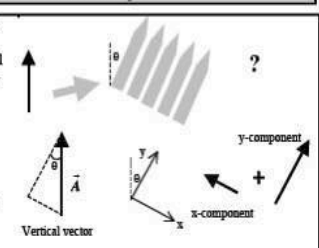

Suppose that the vertical object acts like a vector, and is equivalent to the sum of its components in any coordinate system. In terms of A (the length of the vector) and θ , how much of the vector will make it through the picket fence?

Demonstration 2: Consider unpolarized light, which consists of electromagnetic waves with an electric field vector, \vec{E}_0 , that oscillates in every transverse direction. A piece of Polaroid (polarizer) works just like the picket fence in Demonstration 1. If unpolarized light of intensity I_0 is incident on the polarizer, what is the intensity, I , of the polarized light that passes through?

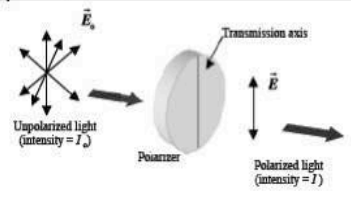

Demonstration 3: Light is polarized vertically and then sent through a polarizer that has its transmission axis oriented horizontally. Will any light be transmitted through the horizontal polarizer?

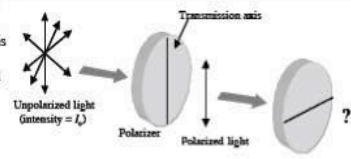

If your prediction is yes, what percentage of the incident intensity, I_0 , will be transmitted?

Figure 7. Excerpt from the Polarized Light ILD Prediction Sheet.

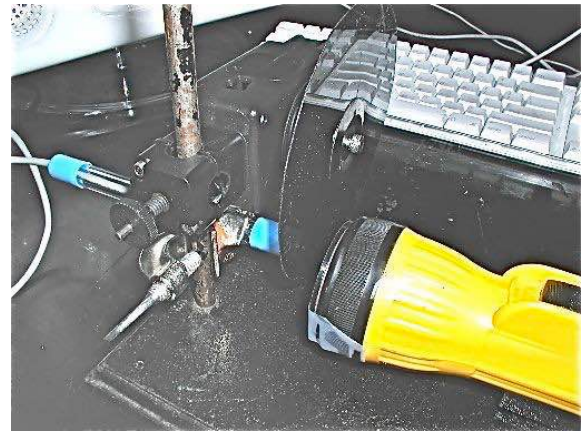

Figure 8. Computer-based apparatus used to analyze polarized light.

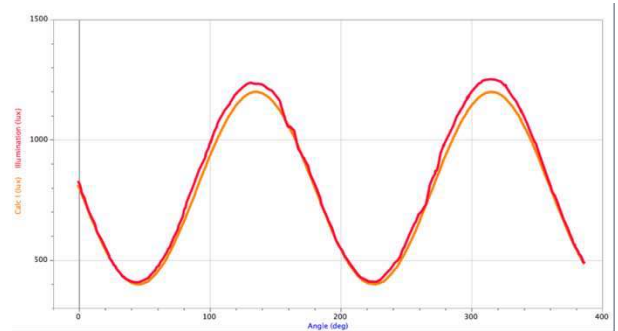

Figure 9. Graphs of the data collected with the apparatus in Figure 8, and an $\text{Acos}^2\theta$ model for Intensity vs. Angle.

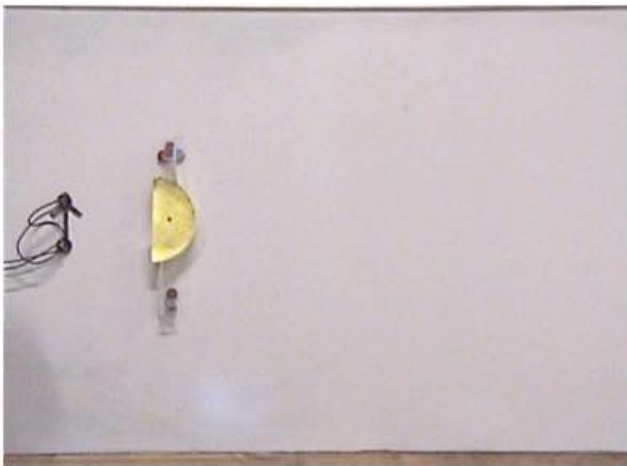

Figure 10. Apparatus for the Image Formation with Lenses ILDs consisting of two small light bulbs and a large cylindrical lens.



Figure 11. Apparatus in Figure 10 with both bulbs lighted, and the top half of the lens blocked by a card. Compare to Figure 3.

The activity from RTP Module 4, described in section II, has also been adapted to the Image Formation with Lenses sequence of ILDs. When done as ILDs, two flashlight bulbs are used as the point sources of light, and a large cylindrical lens (like the one available in Blackboard Optics sets [13]) is used to make the demonstration visible for the entire lecture class. Figure 10 shows the apparatus, and Figure 11 shows the result with half the lens blocked (corresponding to Figure 3). Figure 12 is a sample of the Prediction Sheet

used by students to record their predictions for this sequence of *ILDs*. The learning gain on the *LOCE* image formation questions from the post-test when students experience this sequence of *ILDs* is a very significant 80%!

4. Optics Magic Tricks

The author first developed a series of simple optics demonstrations presented as magic tricks to use in Saturday morning magic shows at a hands-on science center that he directed (the Eugene, OR, USA version of the Exploratorium). He has since used them in his general physics classes at the University of Oregon, in his son's third grade class and for first and fourth graders at a school in Melbourne, Australia. While most of these demonstrations are not unique or original, the context of doing them as magic tricks is new. Students' interest is captivated by presenting the demonstrations in this way, and they are engaged in the learning process. While developing the geometrical optics module for an international active learning workshop for teachers (see the next section), he made the learning with these magic tricks more active by developing sets of discussion questions for small group work to accompany the demonstrations.

The four magic tricks presented in this workshop and the concepts they demonstrate were (1) Reappearing Test Tube (reflection from a transparent object and index of refraction), (2) Candle Burning Under Water (properties of the image formed by a plane mirror), (3) Coal to Silver (total internal reflection) and (4) Falling Laser Beam (total internal reflection and fiber optics). Tricks (1) and (2) are appropriate as introductions to the concepts, while tricks (3) and (4) might best be used to reinforce concepts that have already been presented in class. Some details on trick (1) will be given here. Complete details on all of these tricks (and eight others illustrating other optics concepts) are available from the author.

Reappearing Test Tube

A test tube is held up in the air for all to see, then placed in an envelope and smashed with a hammer, rock or other object. A volunteer is asked to look into the envelope to confirm that only pieces of the tube are present. The demonstrator then says that s/he can make the test tube reappear whole, and pours the glass pieces from the envelope into a transparent container filled with a "magic" fluid. A magic wand is waved over the container, and, after saying the magic word (e.g., "PHYSICS"), a whole test tube is removed from the container. Figure 13 shows the container containing the "magic" fluid after the pieces of glass have been poured in, and Figure 14 shows the demonstrator removing a whole test tube from the fluid. For dramatic effect—and to elicit a good laugh—it is fun to then pull a second whole test tube from the magic fluid.

Figure 15 shows the discussion questions used for small group discussions about this magic trick. To help students in thinking about these questions, the demonstrator also holds a clean test tube in the air again, and then submerges it under water in a separate, identical transparent container.

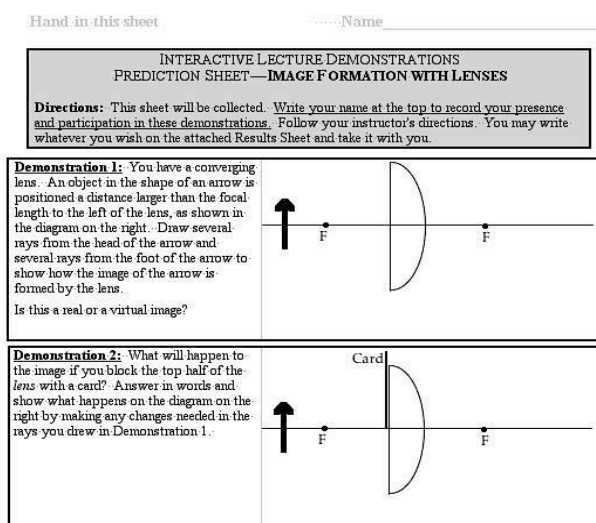

Figure 12. Excerpt from the Prediction Sheet on which students record their predictions for the *Image Formation with Lenses* *ILD* sequence.



Figure 13. Container containing "magic" fluid and pieces of shattered glass test tube.

Preparation and Materials

The easiest way to set up this trick is to use vegetable oil as the magic fluid and a Pyrex© glass test tube. Any vegetable oil has nearly the same index of refraction as this glass, so that the whole test tube (or two test tubes) placed in the container before class cannot be seen by the students. (In fact, the author has “performed” this trick all around the world, and the vegetable oil provided has always worked! Alternatively, a mixture of light and heavy mineral oils can be used to match the index of refraction of Pyrex© or any other common glass.) Because the index match is not exact, a white background behind the container can help to make the test tube(s) be invisible.

Explanation

Transparent objects only reflect and refract light when they are in a medium with different optical properties (a different index of refraction). Since the “magic” fluid has the same index of refraction as the tube, no light is reflected to the students’ eyes by the submerged tube. Therefore, they cannot see it. They can see the tube in air or water because air and water have different indexes than the tube. When volunteers share their small groups’ discussions with the whole class, they are always able to explain that the “optical properties” of the glass are the same as the “magic” fluid, even if they do not yet know the meaning of “index of refraction.” For students who have studied index of refraction, the observations in this trick help support the $(n - n')^2$ dependence of the reflectance for the plane interface between two transparent media of indices of refraction n and n' (e.g., air and glass).

For one more dramatic effect after the class discussion, the demonstrator slowly submerges another dry test tube open side up so that the oil flows over the rim. The tube will appear to the students to disappear from the bottom up. Some students have even described that it seems to disappear in a flash!



Figure 14. Whole test tube removed from the “magic” fluid after the magic wand is waved over it and the magic word is recited.

Discussion Questions for Optics Magic: Reappearing Test Tube

1. How do you think that the test tube was made to reappear?
2. Why can you see a test tube in air or in water, but not in the magic fluid? What is special about the magic fluid?
3. What property of transparent media determines whether reflection takes place at the boundary between them? What has to be true about this property for the two materials in order for reflection to take place?
4. What about the light that is transmitted through the test tube? How is it affected when the test tube is in the magic fluid and when the test tube is in air?

Figure 15. Questions used for small group discussions about the Reappearing Test Tube magic trick.

5. Active Learning in Optics and Photonics (ALOP)

Beginning in 2004, Dr. Minella Alarcon, Program Specialist (now retired) for Physics and Mathematics at the United Nations Educational Scientific and Cultural Organization (UNESCO) in Paris worked with an international team of physics educators to develop a five-day workshop for teachers of introductory physics at the college and secondary levels on Active Learning in Optics and Photonics (ALOP). While UNESCO has coordinated and funded this project, additional support has come from the Abdus Salam International Center for Theoretical Physics (ICTP), the International Society for Optical Engineering (SPIE), the

American Association of Physics Teachers (AAPT), the National Academy of Sciences (NAS), the Association Francaise de l'Optique et Photonique, and Essilor.

UNESCO chose to develop this workshop curriculum on optics and photonics because it is an emerging field in contemporary physics and is relevant and adaptable to research and educational conditions in many developing countries. Photonics is basically applied geometric and physical optics—topics that teachers in developing countries often shy away from due to lack of equipment and lack of familiarity with the topics. ALOP is a professional development workshop targeted specifically to opening up jobs and research opportunities in fields such as optometry, atmospheric physics research and communications for students in the emerging global economy.

ALOP has the following attributes:

1. It is designed for secondary and first year introductory physics faculty in developing countries.
2. It includes teacher updating and introduction to active learning approaches.
3. It features workshops that are locally organized.
4. It uses simple, accessible, inexpensive apparatus available locally or easily constructed.
5. Equipment sets are distributed at the end of each workshop.
6. It was designed by an international team of teacher trainers from developing and developed nations who volunteer their time as facilitators. The team has broad experience with a variety of teaching environments, cultural differences and the educational needs of peoples from many nations.
7. It provides teachers with tools for motivating student learning because the topics are introduced in a coherent and inherently fascinating way.
8. It replaces lectures with sequenced activities involving direct engagement with the physical world, informed by Physics Education Research (PER).
9. It provides participants with a PER-based conceptual evaluation that allows teachers to measure student learning.
10. It provides illustrated and guided inquiry materials for students and teachers' guides with descriptions of apparatus that can be translated into local languages and adapted to meet local needs.

The original ALOP team that designed the ALOP curriculum (now led by Dr. Joseph Niemela of ICTP) includes David Sokoloff (University of Oregon, U.S.), Zorha Ben Lakhdar (University of Tunis, Tunisia), Vasudevan “Vengu” Lakshminarayanan (University of Waterloo, Canada), Ivan B. Culaba and Joel Maquiling (Ateneo de Manila University, The Philippines), and Alex Mazzolini (Swinburne University of Technology, Australia). More recent but significant additions to the team have included Souad Lahmar (University of Tunis, Tunisia), Khalid Berrada (Cadi Ayyad University, Morocco), Cesar Mora (National Polytechnic Institute, Mexico) and Angela Guzman (University of Central Florida, U.S.). Each member of the team brings a unique set of experiences and talents to ALOP.

ALOP's intensive workshop illustrates active learning pedagogy through carefully crafted learning sequences that integrate conceptual questions and hands-on activities like those found in *RealTime Physics*. Topics that require more expensive equipment or extra time on the part of students are presented as *Interactive Lecture Demonstrations*. Some ALOP curricular materials can be introduced in either format. The ALOP Training Manual [10] contains six modules, each of which has embedded applications that are designed to intrigue students and help them realize that the basic physics has vital practical applications. The applications are designed to help students understand their everyday world and become aware of career opportunities based on the principles they are learning. Some of the questions explored in the six modules are:

Introduction to Geometrical Optics

How does an understanding of refraction explain how a broken test tube can be tossed in a container of “Magic” fluid and brought out whole? How can the concept of critical angle be used to explain why a laser beam can be confined inside a stream of water that moves in a parabolic path? Why does covering half a lens result in a different image than covering half the object?

Lenses and Optics of the Eye

How do spherical and cylindrical lenses focus light? How can spherical lenses be used to model a normal eye? How can external lenses correct near and far sightedness. How do cylindrical properties of the lenses in the eye cause astigmatism?



Figure 18. A group of participants in ALOP Tunisia (2005).



Figure 19. A group of participants in ALOP Thailand (2013).

There has also been a second generation of ALOPs taught by previous participants in their local languages. The ALOP Training Manual has been officially translated into French and Spanish. There are also unofficial translations in Arabic, Armenian and Georgian. Two good examples of the potential multiplying effect of a single ALOP and the impact on teacher enhancement in active learning in Latin America are ALOP Sao Paulo, Brazil and ALOP San Luis Potosi, Mexico, both held in 2007. ALOP Sao Paulo was one of three mandated by the World Conference on Physics and Sustainable Development held in Durban, South Africa in 2005 [14]. Participants in this ALOP, principally those from Argentina began meetings during the workshop that led to the creation of a workshop series “Aprendizaje Activo” in Optics (2008), Mechanics (2009), Electricity and Magnetism (2010), and Thermodynamics and Fluids (2011) with funding independent of UNESCO. The principal members of this team were Julio Benegas, Graciela Punte, Graciela Romero, and Graciela Utges, all from Argentina, and Cesar Mora from Mexico. As for ALOP San Luis Potosi, Angela Guzman (Colombia/Florida) who attended organized two additional ALOPs in Bogota, Colombia (2009) and Santiago, Chile (2010). Angela has also arranged to have ALOPs co-located with LACCEI engineering conferences in Arequipa, Peru (2010) and Medellin, Colombia (2011), with funding independent of UNESCO. Note that all of these Latin American ALOPs have been attended by participants from all over Latin America, not just from the host country. A similar multiplying effect has taken place in North Africa, organized by the Tunisian and Moroccan participants in ALOP Tunisia (2005) and ALOP Morocco (2006). The *Light and Optics Conceptual Evaluation* has been administered as a pre and post-test at each ALOP. This has been done both to introduce learning assessment and action research to the participants, and to assess their learning in the workshop. For example, the participants in ALOP Quezon City (November, 2010)—who were mostly secondary physics teachers from all over The Philippines—averaged 80% on the post-test, a 63% gain from the pre-test. On the image formation question illustrated in Figure 6, they improved from 48% on the pre-test to 79% on the post-test.

The ALOP team was awarded the 2011 SPIE Educator Award “in recognition of the team's achievements in bringing basic optics and photonics training to teachers in the developing world.” [15]

6. Conclusion

This paper has presented some innovative uses of active learning in teaching optics, in both the developed and developing worlds. *RealTime Physics and Interactive Lecture Demonstrations* are used extensively in introductory physics classes in the U.S. to enhance student learning of physics concepts. The Active Learning in Optics and Photonics (ALOP) series of workshops has been highly successful in introducing these active learning strategies in the developing world.

Acknowledgements

The author thanks Rosa Maria Sperandeo-Mineo and Claudio Fazio of the Università di Palermo for inviting him to present this workshop at the 2014 GIREP conference in Palermo. He especially thanks Claudio for his help with equipment and arrangements for the workshop. He also thanks the ALOP team, Alex Mazzolini, Ivan Culaba, Joel Maquiling, Vengu Lakshminarayanan, Zohra Ben Lakhdar, Souad Lahmar, Khalid

Berrada, Cesar Mora, Angela Guzman and Joe Niemela for their collaboration on this inspiring adventure in active learning.

References

- [1] Thornton, Ronald K. and Sokoloff, David R. (1998). Assessing Student Learning of Newton's Laws: The *Force and Motion Conceptual Evaluation* and the Evaluation of Active Learning Laboratory and Lecture Curricula, *Am. J. of Phys.* **66**, 338-352.
- [2] Sokoloff, David R., Thornton, Ronald K. and Laws, Priscilla W. (2007). *RealTime Physics: Active Learning Labs* Transforming the Introductory Laboratory, *Eur. J. of Phys.*, **28**, S83-S94.
- [3] Sokoloff, David R., Laws, Priscilla W. and Thornton, Ronald K. (2011). *RealTime Physics, 3rd Ed., Module 1: Mechanics, Module 2: Heat and Thermodynamics, Module 3: Electricity and Magnetism and Module 4: Light and Optics*, John Wiley and Sons, Hoboken, NJ, USA.
- [4] Sokoloff, David R. and Thornton, Ronald K. (2004). *Interactive Lecture Demonstrations*, John Wiley and Sons, Hoboken, NJ, USA.
- [5] Sokoloff, David R. and Thornton, Ronald K. (1997). Using Interactive Lecture Demonstrations to Create an Active Learning Environment, *The Phys. Teach.* **35**, 340.
- [6] John Wiley and Sons data, July, 2014.
- [7] Sokoloff, David R. (2011). *RealTime Physics, 3rd Ed., Module 4: Light and Optics*, John Wiley and Sons, Hoboken, NJ, USA.
- [8] For example, Goldberg, Fred G. and McDermott, Lillian C. (1987). An investigation of student understanding of the real image formed by a converging lens or concave mirror, *Am. J. of Phys.* **55**, 108-119.
- [9] See for example the lens available from Pasco Scientific, http://www.pasco.com/prodCatalog/OS/OS-8492_cylindrical-lens-introductory-optics/index.cfm
- [10] Sokoloff, David R., ed. (2006). *Active Learning in Optics and Photonics Training Manual*, UNESCO, Paris, France.
- [11] See for example <http://www.vernier.com/products/sensors/rmv-btd/>
- [12] See for example <http://www.vernier.com/products/sensors/ls-bta/>
- [13] See for example <http://sciencekit.com/blackboard-optics-kit/p/IG0023843/> A clear plastic food storage container filled with water can be used as a cheaper alternative. See Figure 17.
- [14] See <http://www.wcpsd.org> and <http://www.wcpsd.org/upload/resolutions-final.pdf>
- [15] See <http://spie.org/x45049.xml>

Affiliation and address information

David Sokoloff
Department of Physics
1274 University of Oregon
Eugene, Oregon 97403-1274 USA
e-mail: sokoloff@uoregon.edu

Evaluation for Undergraduate Programs: The Case of the BS Applied Physics in the University of San Carlos

Cherile Obate- Yap¹, Enriqueta D. Reston²

¹ Department of Physics, University of San Carlos, Cebu City, Philippines

² Science and Mathematics Education Department, University of San Carlos, Cebu City, Philippines

Abstract

This paper presents a customized model based on Context-Input-Process-Product (CIPP) Evaluation Model by Stufflebeam (2007) for curriculum evaluation of undergraduate programs using the case of the five-year Bachelor of Science in Applied Physics in the University of San Carlos. The evaluation model assessed different aspects of the program. Data were collected from multiple sources through survey, questionnaires and interviews, documents and class observations. Survey respondents included 75 students and 59 alumni, 6 employers, and 8 teaching faculty. The research findings:

Context evaluation (*program relevance and relevant skills*). The program was relevant to the alumni's present career; highly relevant to the alumni working in the manufacturing industry, teaching, and enrolled in graduate programs while moderately relevant to the majority who were employed in Business Process Outsourcing (BPO) industry and software industry.

Input evaluation (*quality of students and the teaching faculty*). The students have the potential to pursue careers in science. They have an average Intelligence Quotient (IQ) and above average English Proficiency Test (EPT) score. In terms of faculty, they are academically qualified in both teaching content and research.

Process (*teaching-learning methods and assessment of learning*). Delivery and assessment were prominently in the traditional lecture format and paper-and-pencil tests.

Product (*post-graduation success and graduation rate*): The alumni were employed in a range of different areas or taking up graduate studies. Graduation rate relative to freshmen stands at 61.6% covering a span of six academic years SY 2002-2003 to SY 2011-2012.

While the BS Applied Physics program has achieved its goals in providing good education and preparation for careers in industry, Physics teaching and research, this study recommends that the Department reviews its program offerings periodically to address the evolving needs of the employment sector, thus, making the program updated and relevant.

Keywords: CIPP Evaluation Model, BS Applied Physics, program relevance, Context, Input, Process, Product, Generic skills

1. Introduction

In recent years, great demands for renewed focus on higher education are noted. The primary reason is the disparity between college graduates' skills and the skills needed for employment (Hooker, 1997). The society requires new sets of skills and capabilities. Consequently, higher education institutions needs to continuously update the delivery of its academic programs to produce graduates that can cope with the demands of a rapidly changing global society. Along this line, curriculum evaluation is a significant undertaking as it can shed light on how academic programs fare outside of school-life, providing a good picture of programs' "state-of-affair". The results of evaluation subsequently drive revisions and improvements of some parts of the program or of the entire program. Hong (2007) affirms that curriculum evaluation may be perceived differently from different people. Hong further cited that, to Scriven (1967), evaluation is judging the worth of a program; to Stake (1967), it is describing the program as fully as possible; to Tyler (1942), it is documenting how well program objectives are met; and to Stufflebeam (1969), it is providing useful information to decision makers. With all these views put together, the importance of curriculum evaluation cannot be underestimated because it is like shining light on the curriculum, revealing its strengths and weaknesses, thereby, providing direction to the next line of action to be taken to improve it (Alade, 2006).

In particular, Physics programs in several countries have been evaluated in different aspects of skills development. Studies include that of Ivie and Stowie (2002) in the United States, Hanson and Overton (2010) in the United Kingdom, Sharma et al. (2008) in Australia, and Shin and Fatin (2012) in Malaysia. Their findings revealed that Physics graduates ranked high on technical skills, problem solving skills and cognitive skills but skills of communication and team-work, leadership and interpersonal skills, which are considered to be more essential in today's employment are often not well developed. In terms of teaching-learning process, Sharma, Swan, Mills, Pollard, Mendez, Byrne (2009) relate that most Physics faculty, particularly, in Australia conduct researches for effective teaching practices that can enhance students' generic skills' development. These practices are research-based, interactive, and enhance students' active engagement in the classroom. Hake (1998) stressed that active learning methods are developed in response to the limitations of effective student learning using the traditional teaching framework.

In the Philippines, the University of San Carlos (USC) has renewed an undergraduate Physics program from the traditional 4-year BS Physics to a 5-year BS Applied Physics. The impetus for revision primarily rest on widening the graduates' job opportunities, which according to the Dutch consultant Dr. Gerrit Kuik, was previously limited to high school and college teaching. With the 5-year program, students can be accorded better training and foundation for various employment and graduate studies. In retrospect, the Physics Department jointly undertook the Physics Development Project (PDP) with the Free University of Amsterdam from Years 1995-2002. The project was funded by the Dutch government. Kuik further noted that *“by introducing experiences that would provide students good training in physics concepts, analyzing problems, giving solution to problems and developing experimental skills and research skills, students can be better prepared for employment.”*

Since the implementation of the program in AY 2002-2003, there was no evaluation conducted. Egon Guba, as cited by Stufflebeam and Shinkfield (2007), expressed that the most important purpose of evaluation is not to prove, but to improve. Thus, as basis for continuous program improvement and in line with the USC's Mission statement to develop transformative and relevant programs that are responsive to the needs of society and the global community, a research-based curriculum evaluation of the BSc Applied Physics program was conducted using the CIPP Evaluation Model. The CIPP Model is a comprehensive framework for guiding formative and summative evaluations of programs, projects, personnel, products, institutions, and systems (Stufflebeam & Shinkfield, 2007). The curriculum evaluation based on the CIPP Model sought to answer the following questions:

- As to the context basis of the BS Applied Physics curriculum, is the curriculum relevant to the current employment of the alumni?
- Are there significant gaps between extent of employment needs of the generic skills and the extent of development or learning of these skills?
- As to program inputs, what are students' profile based on demographic characteristics and IQ/EPT characteristics and faculty's profile based on demographic characteristics, professional, and teaching attributes?
- As to process evaluation, are the Physics faculty implementing research-based learning methods of delivery and assessment?
- As to product evaluation, what is the level of output in terms of graduation, retention, and dropout rates, and post-graduation success (as indicated by either enrolment in graduate studies and/or employment)?

The conceptual framework of the study, along with the operational definition of the constructs used, is shown in Figure 1.

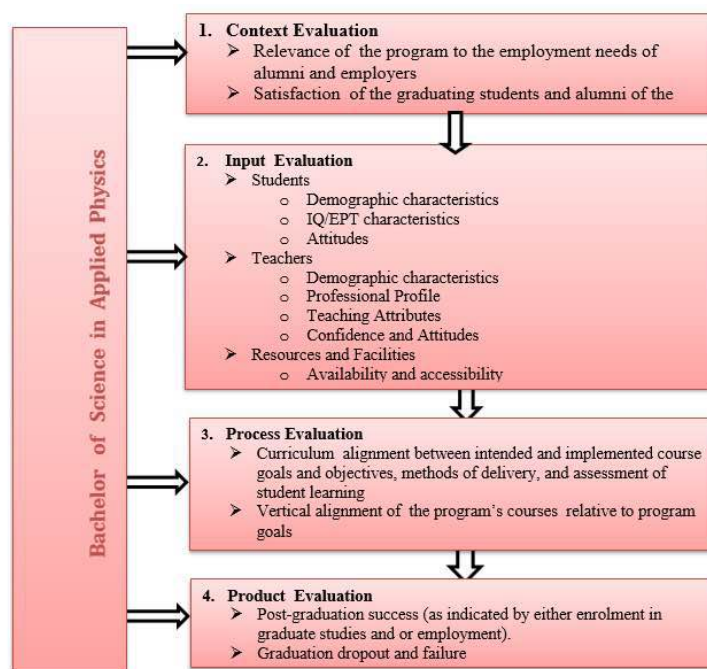

Figure 1. Conceptual Framework of the study

2. Research methods

This curriculum evaluation research employed both quantitative and qualitative methods for data collection and analysis. The data were collected from multiple sources through survey, questionnaires and interviews, documents and class observations. Institutional and department records and documents were used to get alumni's addresses, students' admission test data in terms of IQ and English Proficiency Test (EPT data), and Physics program enrollment. Surveys using questionnaire and semi-structured interviews were used to probe alumni and employers' perceptions on the relevance of the program and skills learned and needed in the workplace. The survey instruments for the alumni and students were initially pretested and piloted for validity and reliability. Alumni and students' questionnaires were reliable with Cronbach alpha ranging between 0.86 and 0.91.

Respondents

The study population comprised of 59 out of 70 BS Applied Physics alumni, over a span of five batches covering the period from 2007 to 2011; 75 students enrolled in the program during SY 2011-2012, 6 employers and 8 instructors. The 6 employers who responded to the survey represented the Business Process Outsourcing Industry, software industry, semiconductor industry, and thin film optical filters industry.

Treatment of Data

Quantitative data were analyzed and summarized using descriptive statistics and paired samples t-test for comparison between groups using SPSS[®] 16.0 for Windows. For the qualitative data, the analysis involved document and content analysis, extracting common themes or categories from the responses.

3. Results

3.1 Context evaluation

3.1.1 Program Relevance

On program relevance, the alumni respondents perceived that the Physics program was relevant to their employment and careers with a mean rating of 3.13 ± 1.19 in a scale from 1(not relevant) to 5 (extremely relevant). The standard deviation (SD) of 1.19 indicates the higher degree of variation in alumni's responses. Regarding specific jobs, the program was perceived as highly relevant to seven alumni, representing 11.9% of the total respondents, who are teaching high school and college Physics; 7 alumni working in manufacturing industry (11.9 %), and 4 alumni (6.8 %) enrolled in graduate Physics program. On the other

hand, the program was moderately relevant to the 20 alumni (33.8 %) in the BPO industry, 11 alumni (18.6 %) in the software industry; and 6 alumni (10.2%) in a retail business company.

3.1.2 Generic Skills

In view of the goal of the program, self-assessment data from the alumni were collected regarding the extent of employment needs and learning of generic skills, abilities, and attribute. The range of ratings matching employment needs and academic learning were from 1 – not needed (no learning) to 5 – extremely needed (excellent learning). The mean scores are shown in Table 1. Observed gap were calculated by subtracting the respondent's perception of degree of learning and degree of employment need. Positive scores suggest that there is apparent "skills gap." The largest discrepancy is that of leadership skill followed by the skill to perform quality work, time management skill, computer skills, and teamwork skills.

Analyzing further the data using two-sample paired t-tests revealed that skills gap were significant in five skills ($t = -2.92$ to 2.15 ; $df = 54$; $p > 0.05$); leadership, ability to perform quality work, time management, teamwork, and ability to learn new skills. The rest of the skills show non-significant gaps between degree of employment need and learning.

Table 1. Assessment of Learning and Employment Need (Cluster B Skills and Abilities)

Skill, Ability, Attribute	Employment Need* (N) Mean \pm SD	Learning ** (L) Mean \pm SD	Gap	p-value
• leadership skill	4.33 \pm .97	3.52 \pm .81	0.81	0.00 (S)
• ability to perform quality work or product	4.87 \pm .34	4.10 \pm .65	0.77	0.00 (S)
• time management skills	4.63 \pm .61	3.88 \pm .79	0.75	0.00 (S)
• computer skills	4.44 \pm .53	3.78 \pm 1.20	0.67	0.14 (NS)
• teamwork skills	4.45 \pm 1.06	3.94 \pm .81	0.51	0.00 (S)
• ability to learn new skills	4.78 \pm .55	4.33 \pm .59	0.45	0.00 (S)
• independent learning	4.41 \pm .69	4.15 \pm .72	0.26	0.13 (NS)
• analytical skill	4.41 \pm .75	4.22 \pm .58	0.19	0.26 (NS)
• problem solving	4.15 \pm .77	4.11 \pm .57	0.04	0.82 (NS)
• written communication	4.19 \pm .96	4.07 \pm .78	0.12	0.60 (NS)
• oral communication	3.89 \pm 1.08	3.93 \pm .82	-	0.87 (NS)
• critical thinking	4.44 \pm .80	4.48 \pm .60	-	0.85 (NS)

*1 – not needed, 2 – slightly needed, 3 – moderately needed, 4 – sufficiently needed, 5 –extremely needed

**1 – none , 2 –little, 3 – fair, 4 – good, 5 - excellent

S- significant gap; NS –not significant gap

3.2 Input Evaluation

3.2.1 Students' profile

The student surveys revealed that the BS Applied Physics program attracted students with potential for pursuing career in science. Most of them are male (53.3%) and majority of them are government scholars (81.3%). In terms of cognitive potential, students' mean IQ is 109 ± 9 which is generally described as *average*, and the mean English Proficiency Test (EPT) score of 82 ± 16 is considered *above average*. They chose to enroll in the program because of personal reasons and predispositions towards science rather than opinions from other people.

3.2.2 Faculty profile

A total of 8 faculty members of the Physics Department consistently teach the major Physics course over the past several years since AY 2002-2003. Their ages range between 31 and 43 years old and their teaching experience at USC ranges from 10 to 20 years. Three of them are PhD Physics degree holders and 5 are MS Physics holders. Six faculty expressed that their dominant teaching style is lecture with emphasis on developing students' problem solving skills and applying Physics to everyday living. All of the respondents were confident in terms of knowledge in Physics and were likewise confident in supervising student research. Seven faculty reported to have high level of motivation, both in teaching and in conducting research in the field.

3.3 Process Evaluation

Researcher's observations revealed that the delivery of lessons in all classes (courses) was teacher-centered and content-based. The lecture format dominated most of the class time although there were differences in students' level of participation and interaction. In three of the six classes, students were generally passive, often watching or listening to the teacher and taking down notes. The faculty were focused on the content of the lectures and there was less time for student-teacher interaction. But oftentimes instructors never missed asking students if they had questions regarding the lessons. Occasionally, while lecturing, some instructors were not able to notice the body language of few students. Physics problem was almost always the focus of lectures. Students solved problems in class and sometimes outside of the classroom.

Assessments were generally written tests. The type of tests were primarily in multiple choice formats and content-wise, they were focused on problem solving. Open-ended tests or essay tests and projects contributed in the assessment but only to a limited extent. Only three faculty indicated they would use projects as part of student assessment. Feedbacks from students apparently elucidate the need to improve assessment methods. For instance, common comments from students shed light on how some of them were discontented on the way they were assessed.

3.4 Product Evaluation

3.4.1 Post-graduation success

Table 2 shows the job profile of the 59 alumni. Ninety-five per cent are employed, 2 (3%) are self-employed, and 4 (2%) is pursuing graduate research. Among those employed, the nature of their work is diversified. BPO industry employed the highest percentage of alumni, followed by software industry, and with retail Business Company, educational institutions, and manufacturing industry having employed an equal number of graduates.

Table 2. Job Profile of BS Applied Physics Alumni

Nature of Company	# of alumni employed	Percent (%)
• Business Process Outsourcing	20	33.8
• Software	11	18.6
• Educational Institution (College & High School Teaching)	7	11.9
• Manufacturing Industry (Telecommunication/ Semi-conductors /Food & Beverage)	7	11.9
• Retail Business Company	6	10.2
• Graduate program/Physics Research	4	6.8
• Self-employed (business)	2	3.3
• Banking	1	1.7
• Medical program	1	1.7

3.4.2 Graduation, retention, and dropout rates.

Overall graduation rate relative to freshmen stands at 61.6% covering a span of six academic years from SY 2002-2003 to SY 2011-2012. The dropout rate varies by year level with the highest dropout from 1st year to 2nd year transition at 20.7%. Retention rate is relatively high in each transition ranging from 79.3 to 100 %.

4. Discussion and conclusion

Based on the findings, there is an adequate evidence that BS Applied Physics program has achieved its goals in providing good training to the alumni in preparation for physics teaching, research, graduate studies, and for careers in applied physics. It has provided the needed learning and development of technical skills in line with its program goals. Moreover, alumni's perception of relevance of the program is relative to their current careers or employment. With the changes in the economic and employment landscape of the country characterized by increasing dominance of outsourcing services, a great percentage of the graduates were employed by BPOs and the need for development of "soft skills" were found to be inadequate for most of these graduates. This suggests that the USC Physics Department has to put more effort to reinforce soft skills development at an even pace with the hard skills development.

On the other hand, while program input in terms of the quality of students and the teaching force, the process evaluation showed some need to adopt diverse teaching-learning strategies rather than rely on traditional lecture format and written tests format for assessment. Laws, Sokoloff and Thornton (1999) posited that considerable evidences were collected by researchers in physics teaching and learning revealing that traditional instructional methods – largely lecture and problem solving are not effective in promoting conceptual learning in physics as compared to active learning methods. Even if there is no student learning gains difference between traditional and active learning classrooms, Hanze and Berger (2007) proved that there are differences in students' experience of the three basic needs like autonomy, competence, and social relatedness.

There is higher dropout in undergraduate program worldwide (Junior, Ostermann, and Rezende (2011)). While the BS Applied Physics of USC registers lower dropout rate as compared to other Physics programs (Saloma, 2008; Junior, Ostermann, & Rezende, 2011) but even so, there is a greater need to lessened it and improve graduation rate because according to Yorke, Mantz, Longden, and Bernard (2004) "Student retention and attrition are policy significance to higher education around the world. Governments want higher education to be as effective and efficient as possible."

In general, evaluation is valuable as it provides feedback and motivation for the continued improvement not only of the overall program, but also in achieving better-quality development of graduates' knowledge, competence, skills, abilities, and attributes, faculty's academic qualifications and confidence. All these developments are necessary in order to meet the demands of the fast –changing national and global economy. In particular, evaluation is inevitable since Physics is considered to be the foundation in the realm of industrialization and information technology. Evaluation of Physics programs relates not only to the employability of the graduates but accountability of Higher Education Institution to the students, students, parents, employers, and the community.

References

- Alade, I. A. (2006). Evaluation of technical education curriculum in colleges of education in southwestern Nigeria (Doctoral dissertation, Ph. D. Thesis. Department of Teacher Education, University of Ibadan. Xxii+ 257).
- Hake, R. R. (1998). Interactive-engagement versus traditional methods: A six-thousand-student survey of mechanics test data for introductory physics courses. *American journal of Physics*, 66, 64.
- Hanson S. and Overton T, (November 2010). Skills required by new Physics graduates and their development in degree programmes. *Higher Education Academy UK Physical Sciences Centre*
- Hänze, M., & Berger, R. (2007). Cooperative learning, motivational effects, and student characteristics: An experimental study comparing cooperative learning and direct instruction in 12th grade physics classes. *Learning and Instruction*, 17(1), 29-41.
- Hong, S.(2007). Curriculum evaluation: an evaluation of teaching of science in English in a rural School in Sabah. PhD dissertation. School of Education and Social Development of the Universiti of Malaysia, Sabah 370 pp.
- Hooker, M. (1997). The transformation of higher education. In D. Oblinger & S. C. Rush (Eds.) *The Learning Revolution*. Boston, MA: Ankler Publishing Company, Inc.
- Ivie, R., & Stowe, K. (2002). The early careers of physics bachelors. *American Institute of Physics, Statistical Research Center*, College Park, MD, 2002, AIP Pub. R-433.

Laws, P., Sokoloff, D., & Thornton, R. (1999). Promoting active learning using the results of physics education research. *UniServe Science News*, 13, 14-19.

Lima Junior, P., Ostermann, F., & Rezende, F. (2011). Professors' perspectives on dropout rates in undergraduate physics courses. Retrieved January 1, 2014 from http://lsg.ucy.ac.cy/esera/e_book/base/ebook/strand11/ebook-esera2011_LIMA-11.pdf

Saloma, C. A., Concepcion, G. P. P., & Padlan, E. A. (Eds.).(2008). *Selected Essays on Science and Technology for Securing a Better Philippines* (Vol. 1). UP Press.

Sharma, M., Pollard, J., Mendez, A., Mills, D., O'Byrne, J., Scott, D., Hagon, S., Cribble, J., Kirkup, L., Livett, M., Low, D., Merchant, A., Rayner, A., Swan, G., Zadnik, M & Zealey, W. (2008). What does a physics undergraduate education give you? A perspective from Australian physics. *European Journal of Physics*, 29(1), 59.

Sharma, M. D., Swan, G., Mills, D., Pollard, J., Mendez, A., & O'Byrne J. (2009).

Physics learning and teaching in Australian Universities. *CAL-laborate International*, 17(1), 26-40.

Shin, L. W., & Fatin, F. A. (2012). Physics Studies and Generic Attributes. *Procedia-Social and Behavioral Sciences*, 56, 691-702.

Stufflebeam, D. L., & Shinkfield, A. J. (2007). *Evaluation theory, models, and applications* (pp. 240-241). San Francisco, CA: Jossey-Bass.

Yorke, M., & Longden, B. (2004). *Retention and student success in higher education*. McGraw-Hill International.

Affiliation and address information

Cherile Obate- Yap

Department of Physics,
University of San Carlos,
Cebu City, Philippines
Email: coyap@usc.edu.ph, cheryap2057@yahoo.com

Enriqueta D. Reston

Science and Mathematics Education Department,
University of San Carlos,
Cebu City, Philippines
Email: edreston@usc.edu.ph

Investigating Student Ideas on the Connection Between Formal Structures and Conceptual Aspects in Quantum Mechanics

Giacomo Zuccarini, Marisa Michelini

Physics Education Research Unit, University of Udine

Abstract

While research on difficulties of upper division students with mathematics in physics generally shows that the major issues concern the relation between physical meaning and formal structure, this is particularly true for quantum mechanics. There is a need to explore, from student perspective, the complex interaction between quantum concepts and formal aspects, starting from the most fundamental ones, in order to understand challenges and potential of the interplay between quantum physics and mathematics for educational purposes. On the basis of a content and literature analysis, we designed a research on physics student understanding of QM, primarily focused on the central concept of quantum state and its formal representations. Here we discuss first the multifaceted role of mathematics in learning QM, highlighting the importance of the structural aspects, then we report results of the second calibration stage of the study. The research was conducted on six 3rd years physics students by means of a multi-perspective questionnaire, examining the same elements from a global perspective and in the application context of specific problems, as well as with different representations. Two students were interviewed on each item, a third one on a selection of items. Results and consequences concerning the use of math in the building of conceptual knowledge in QM are discussed.

Keywords

University Education, Quantum Mechanics, Conceptual Understanding Mathematics

1. Introduction

Mathematics is an essential component of university physics. Students work in a mathematical learning environment right from the beginning of their study programs, where they are required to use formal entities as representations of physical concepts and relations, as well as to perform lengthy calculations and manipulations. In the process of becoming scientists, students are expected not only to learn an appropriate amount of scientific content, but also to acquire a mastery of formal thinking needed to work with mathematical models of the physical world. That means effectively using mathematical models to examine physical situations and solve problems, evaluating their suitability for the description of a given phenomenon, and eventually producing new ones. For advancement in education, it is very important to understand how student expertise with math in physics evolves in time. A major theme in this field is the exploration of student difficulties, comparing results for advanced students (e.g. at the end of their undergraduate career) with those for introductory course students. Literature shows that, while, manipulation of formulas is not a primary barrier to upper division student success (Thompson, Bucy, & Mountcastle, 2005; Wilcox et al., 2013), they struggle to combine calculations with physical ideas and in particular to access the mathematical tools suitable to represent a physical concept or relation (Thompson, Bucy, & Mountcastle, 2005; Bucy, Thompson, & Mountcastle, 2006; Loverude, 2009; Pepper et al., 2012). As these problems are also common among introductory course students (Pepper et al., 2012), it is evident that major difficulties with math are not overcome during undergraduate education. Noteworthy, all aforementioned studies address classical topics and related mathematical tools, most of which had already been encountered by students in introductory courses. When we come to new and challenging subjects, such as quantum mechanics (QM), the picture gets worse. While QM is a technically sophisticated subject, the worst problems emerged on the connection between physical meaning and the most fundamental tools of the theory. Students struggle to discriminate between the role of the Schrodinger equation and of the energy eigenvalue equation (Singh, Belloni, Christian, 2006). They show difficulties with the formal representation of observables, e.g. interpreting the action of an operator on the state vector as a measurement (Singh, 2008). They evidence problems with the representational role of the wavefunction, e.g. interpreting a reduction in its amplitude as a loss of energy (Wittmann, Morgan, & Bao, 2005). In general, students may become skilled at solving

technically difficult exam questions without having developed mental models of fundamental concepts (Robertson & Kohnle, 2009), struggling to use formalism in order to draw qualitative inferences (Singh, 2008), their answers often being isolated mathematical deductions balancing precariously on one another (Johnston, Crawford, & Fletcher 1997). A corresponding change of attitude towards mathematics is evidenced during the junior QM course: after a quarter, students begin to feel that either their mathematical background is not strong enough, or they are not able to make physical interpretation of their solutions, concluding that mathematics is one of their bigger problems in their learning (Sadaghiani, 2005, pp. 72-73).

In general, it is evident that a critical element of the interplay of physics and mathematics in advanced university education lies at the junction between physical description and its formal representation. In this context, QM stands out because the gap between student's use of procedural mathematics and their combination of math with physical ideas is definitely wide. Consequently, upper division quantum physics represents an ideal ground to explore the interplay of physics and mathematics from their perspective.

In order to investigate advanced student understanding of QM, we designed a research exploring both conceptual-global aspects and formal ones, including the interpretation and production of mathematical representations of quantum concepts. The research, primarily focused on the central notion of quantum state, is grounded on an analysis of the basic scientific content of quantum physics and of the founding role of mathematics in the theory. In this paper, we discuss the inherent challenges in learning QM, with particular attention to the multifaceted role of mathematics, and report the results of the calibration stage of the research for what concerns student interpretation of quantum state formalism and translation processes between physical meaning and mathematics.

2. Multiple layers of complexity and the structural role of mathematics in learning quantum physics

As for every topic in physics, learning QM entails acquiring new conceptual and formal tools and building the knowledge structure needed to master those models of the physical world that are specific to the discipline. The more challenging nature of the QM in comparison to other topics can be explained by the concurrence of multiple and intertwined layers of complexity.

The first one is of conceptual character. In order to account for the emergence of the quantum behaviour of system, the theory introduces new concepts defying everyday experience and intuition. To mention some of the most basic, ideal measurement acquires weird features, such as an active nature and a stochastic character, while the very essence of physical systems changes by the introduction of the incompatibility of observables which, according to the standard interpretation (Bub, 1999), hinders a system to possess all measurable properties at the same time. As a consequence, the state of a system – a central theoretical concept in QM - undergoes a crucial meaning shift. In classical mechanics, the state identifies the condition of a system, is specified by the generalized position and momentum properties of the system, and provides the knowledge of all other dynamical properties. In QM, the state identifies instead the behaviour of a system in measurement, and provides the set of probability distributions for measurement outcomes of each observable. From a conceptual point of view, building a quantum perspective requires not only acquiring new unintuitive concepts as fundamental blocks, but also reinterpreting familiar ones in unintuitive ways, as is the case of the central concept of state.

The next levels of complexity concern the role of mathematics. The fact is, the construction of the aforementioned concepts is embedded in highly mathematical structures. New formal entities are adopted to represent states and observables - respectively vectors in abstract infinite-dimensional Hilbert spaces and linear operators in these spaces. As before, familiar formal entities such as basis vectors and their superposition undergo a strong representational shift, and need to be reinterpreted as symbols and relations carrying very different physical meaning from those students are used to. In general, the mathematical shape of quantum theory gives rise to different kinds of complexity, which must be carefully distinguished from each other. A technical one, associated with the sophisticated calculations required in quantitative problem solving, and a structural one, i.e. the role of formal entities in structuring/interpreting physical situations and concepts (Uhden et al., 2012; Karam, 2014). Student difficulties with QM listed in the Introduction are strongly tied to the structural role of mathematics in the theory.

The last forms of complexity to consider in learning concern the effects of the weirdness of quantum physics on representational modes such as language and images/graphs. The use of language in order to productively reason on QM is a complex issue in education, featuring the conflict between the new quantum model and the need to use partial conceptual metaphors referring either to particle or to wave ontologies, depending on the situation at hand (Etkina & Brooks, 2007). Here we'll restrict to highlight the entanglement between verbal/written language and mathematics: even in the description of the most fundamental concepts we can

hardly avoid referring to mathematical structures (e.g. the reference to probability distributions in the definition of quantum state). Coming to visual language, quantum systems and processes are plain and simply not visualizable. Only formal representations of them can – to a certain extent.

For all these concurrent reasons, it is evident that acquiring a quantum prospective is a demanding task even for upper division students. Nevertheless, they suggest an explanation for the controversial role played by mathematics in learning QM. On the one hand, mathematics is a heavy hurdle to student understanding, both because of its technical complexity, and because it's inextricably tied to the construction of concepts which are already unintuitive in nature. Of these two aspects, the structural one is the most influential, with technical manipulations becoming a sort of shelter for students: as testified by research, they often resort to mathematical deductions in order to make up for an insufficient conceptual understanding, and develop survival strategies to at least perform reasonably well in the purely quantitative course work (Singh, 2008). On the other hand, the recognition of the part played by formal structures in basic conceptual aspects, as well as the need to resort to mathematics when working with different representational modes, has a positive potential for instruction. Mathematics can and should be used as an instrument to build mental models of quantum concepts, provided the focus of the intervention is on its structural role, and taking into account that the operationalization in physics courses of mathematical tools learned in math courses is not automatic (Caballero et al., 2014).

3. Research overview and research questions

An important step in order to employ mathematics as a support for building conceptual understanding of QM, is to explore how students cope with the structural role of formal entities. Therefore, in a project aimed at the construction of a teaching/learning proposal on QM for physics students, we designed a research on student understanding of the basic aspects of the discipline including the investigation of structural aspects. The study underwent two separate calibration stages, performed by means of case study methods on 3rd year physics students (Zuccarini, 2014). As quantum state is at the centre both of the conceptual organization of the theory and of its formal machinery, we chose to focus our attention on the connection between this concept and its formal representations. Part of the tasks given to students in the second calibration stage of research can be framed within the structural role of formal entities in its different facets, such as mathematization, interpretation, derivation, and the identification of the essential aspects of physical behaviour that justify the use of those entities in the theory. The investigation included a multi-perspective approach, exploring student understanding in global terms and in the application context of specific problems, as well as by means of different representational modes. Specifically, we explored student identification of quantum processes described by formal representations of quantum state, the translation between these formal structures and physical meaning, and the identification and interpretation of validity conditions for ψ . Our research questions (RQ) are the following:

RQ1: what kind of global vision do students evidence on physical processes whose interpretation requires the use of a formal representation of quantum state?

RQ2: how do students address tasks whose resolution requires the recognition and interpretation of phase difference in $|\psi\rangle$ and ψ , a formal element closely tied to the distinctive process of quantum interference?

RQ3: how do they interpret equations of basis change?

RQ4: how do they interpret mathematical expressions/graphs of ψ with relation to the conditions it has to satisfy in order to represent a physical system?

4. Instruments and methods

Research instruments were developed on the basis of content analysis and of the results of a first preliminary study conducted on three 3rd year physics students by means of a questionnaire and follow-up interviews aimed at collecting student perspectives, their ways of looking and their points of view.

This led to the elaboration of a rubric describing aspects to include and context to explore. The rubric was used to structure a new questionnaire made up of 21 items and organized in six different content sections and on three levels: global-cultural, qualitative-conceptual and formal (state vector, ψ , potential graphs, $|\psi|^2$ graphs). For each aspect, at least two items were designed in order to cross-examine it from different perspectives and representations. An interview protocol was structured to go in depth with student reasoning on questionnaire items. The protocol is divided into two parts: a first one conducted with rogersian method

(Lumbelli, 1997), then by asking a stimulus question on student's written answer and following the dynamical evolution of student reasoning path by means of reinforcing stimuli.

Here we present the results of a second calibration stage designed to identify crucial aspects and finalize data gathering instruments. The questionnaire was administered to six volunteer 3rd year physics students from three different universities: Perugia (1), Calabria (4), Roma-La Sapienza (1). All participants had followed QM course and 4/6 passed the exam two months earlier in the same year. Students were given two-hour time to complete the questionnaire. Two of them were interviewed on each item, a third one on a selection of items.

According to stated RQs, we focus on six items:

-I1 asks about physical contexts (cases, examples, experimental situations) in which it is not possible to avoid using a formal representation of quantum state in order to interpret processes.

-I2, I3, I4 are items whose resolution requires recognition and the interpretation of the role of phase difference. I2 is a mathematization task in the context of Stern-Gerlach experiment, asking students to transpose patterns of experimental data into $|\psi\rangle$ formalism. I3 asks students to derive new results, i.e. to give predictions of measurement outcomes of another observable, based on information gained in I2 and of the equations of basis change. I4 concerns continuous formalism (ψ), and asks students if it is possible to deduce a system's probability distribution in momentum space, given the knowledge of its probability distribution in position space.

I5-I6 are interpretation tasks, asking student to identify valid ψ for a given potential, starting from their mathematical expressions (I5) or from student sketches of $\Re(\psi)$ (I6). Item I5 is taken from Singh (2008).

Written test and interviews were analyzed according to the following qualitative procedure: construction of typical sentences and a-priori categories by identification of crucial conceptual contents and literature analysis on difficulties in QM; revision of categories according to conceptual elements introduced by student answers; identification of emerging element clusters and coherence elements in student reasoning.

5. Results

Item I1

In what physical contexts (cases, examples, experimental situations) is not possible to avoid using a formal representation of quantum state in order to interpret processes?

Figure 1. Item I1

By means of this item, we intended to explore student ideas about contexts and physical situations belonging to the exclusive domain of quantum theory, with a focus on the role of the formal representations of quantum state. Most students (4/6) addressed this item on multiple levels, by looking both at the scale of the systems in general terms and at specific processes or experimental situations: “distances comparable to deBroglie length of the particle, ..., scattering and diffraction of particles” (S1), “For sure in particle physics (atoms and molecules), and in contexts connected to them: for instance, the Stern-Gerlach Experiment” (S6). Half students identified instances of quantum interference as distinctive processes which can only be interpreted in quantum terms: “scattering and diffraction of particles ... there must be a ψ because you cannot explain it in any other way” (S1) “double slit experiments, where interference fringes are due the to the collapse of ψ in that point” (S4), “cases in which particles show a wave nature (Young experiment)” (S3). While one other student mentioned Stern-Gerlach experiments (S6), the remaining two either referred to “the discreteness of measurable values” (S2), or to “the description of atoms and molecules” (S5). The picture emerging from student answers is twofold. On the one hand, the majority was able to identify appropriate physical contexts belonging exclusively to the domain interpreted by quantum state formalism. On the other hand, their general references to the scale of magnitude or to the kind of systems involved, whose properties can be partly accounted for also by classical or semi-classical quantized models, evidenced a difficulty in looking at a context from multiple theoretical perspectives at the same time.

Item I2-I4

I2. A beam of silver atoms (spin-1/2), identically prepared in spin state $|\psi\rangle = \alpha|\uparrow_z\rangle + \beta|\downarrow_z\rangle$, propagates in the y direction. The beam is sent through a Stern Gerlach device with a vertical magnetic field gradient in the z direction. On the screen we observe two identical spots. Transpose this experimental outcome in quantum state formalism and describe your reasoning.

I3. Afterwards, the device is replaced by a similar one, whose magnetic gradient is in the x direction. The beam is sent through it. Can we expect to see two spots, one markedly brighter than the other? Explain your reasoning.

To answer the question, it may be handy to use the following relations:

$$|\uparrow_z\rangle = (|\uparrow_x\rangle + |\downarrow_x\rangle)/\sqrt{2}; \quad |\downarrow_z\rangle = (|\uparrow_x\rangle - |\downarrow_x\rangle)/\sqrt{2}$$

I4. Given a system's probability distribution in position space, is it possible to deduce its

Figure 2. Items I2, I3, I4

The structural of phase difference in quantum state formalism at a point in time is here explored both in the discrete and in the continuous case. Student answers to I2 fall in two broad categories: either trying to reconstruct the phenomenology they expect to observe without giving relations between α and β (2/6), or providing a relation - in one case " $|\alpha|^2 = |\beta|^2$ " (S2), in three other cases " $\alpha = \beta = 1/\sqrt{2}$ " (S1, S3, S6). No student took into account the unknown phase difference between the first and the second coefficient, neither in the written test, nor in interviews, not even S2, whose answer was technically correct. In the last three cases, coefficients were assumed to be real and positive, as if one measurement could provide a total knowledge of the state of system.

While the value of phase difference has no consequences for what concerns measurements of the z component, the problem emerges in I3, where spin in the x direction is measured, and a different value of the phase gives rise to different results. S3 and S4 answered I3 starting from a state vector whose coefficients contain no phase difference, appropriately used the equation of basis change and concluded: we see "only the spot corresponding to $|\uparrow_x\rangle$ ". S1 interpreted basis change equation as containing information on the state of the atoms: "from the formulas it is clear that, in order to see a spot in $|\downarrow_z\rangle$, the difference between $|\uparrow_x\rangle - |\downarrow_x\rangle$ must be different from zero". S5 did not apply basis change, as he assumed that the physical situation was the same as in I2: "Although the direction of polarization is different, the brightness of the spots is the same".

Concerning I4, all six students answered that Fourier transform allows to obtain system's probability distribution in momentum space: «given the fact that we are dealing with conjugate variables, we only need to apply a Fourier transform to the position distribution» (S2). Informative content of phases did not emerge neither in the written questionnaire, nor in interviews: S6: "by looking at ψ in this way [$\psi(x) = A(x)e^{i\varphi(x)}$], I don't think it contains any information. The only informative element in ψ is its square modulus, as the factor $e^{i\varphi(x)}$ has unitary modulus". $\psi(x)$ and $|\psi(x)|^2$ were interpreted as different ways to convey the same physical information. Ignoring the structural role of phase difference can have heavy consequences, e.g. a lack of distinction between measurement and state reconstruction.

Item 15-16

Students are asked to identify valid ψ for a given potential, explaining their reasoning:

I5: in an infinite well between 0 and a , following analytical expressions are given

A) $A \sin^3(\pi x/a)$

B) $A[\sqrt{2/5} \sin(\pi x/a) + \sqrt{3/5} \sin(2\pi x/a)]$

C) $Ae^{-((x-a/2)/a)^2}$

I6: different student drawings of $\Re(\psi)$ are given for different step potentials: e.g. for the infinite well btw $[-a/2, a/2]$:

Figure 3. Items I5-I6

In answering I5, most students (4/6) mention one or more validity conditions: “as functions A) and B) are null in $x = 0$ and $x = a$, they are valid”, “beyond the walls of the infinite well, ψ must be null. ψ must be continuous as well as ψ' (there can be discontinuity of 1° kind)” (S4), “ ψ must be null in those positions and continuous between them” (S1), “boundary conditions must be the same on the walls as concerns ψ and its first derivative” (S5). Students generally manage to identify valid/invalid wavefunctions: all students identify B) as a valid, 4/6 identify A) as valid, while 5/6 recognize that C) is not acceptable. At the same time, only S1 writes something more than a list of conditions, explaining why ψ must be null beyond the wall: “this is an infinite box, therefore the particle cannot be found outside of it”.

The same picture emerges also in graphic representation, where drawings include a discontinuous ψ , one with a cusp and one violating boundary conditions. Students generally discriminate between invalid and potentially valid sketches, but without giving explicit explanations. The only exception, both in written test and in interviews is again S1, as concerns boundary conditions: “I don’t think there can be tunnel effect for an infinite well”.

Another critical element, evidenced coherently in both items, concern technical difficulties with L^2 spaces: two students exclude A) from acceptable wavefunctions as “ \sin^3 is not a superposition of \sin and \cos ” (S3), “in the infinite well I remember that valid states are given by the sum of sine and cosine. Here we’ve got a cube”. In I6, both student expressed doubts about the potential validity of the wavefunction sketched in Fig. 3: “yes, [it can be valid] if it is a superposition of eigenstates” S3. These two students focused on surface features of function superposition, without considering that energy eigenfunctions generate the whole L^2 space.

Last, no student gives reasons for listing continuity, neither mathematical reasons - in position space, Schrödinger equation is a linear second order differential equation, implying the existence of ψ'' - nor physical ones - e.g. avoiding infinite contributions to the expectation value of kinetic energy (Levi, 2006, p. 112). Asked about the reasons behind continuity of ψ , S1 states: «for me its mathematics. In CM everything is continuous, in QM if it isn’t continuous it’s discrete». Interviewer: «And for the cusps?», S1: «I don’t like them, but I can’t say more about it.»

6. Conclusions

On a global level, most students (4/6) identified distinctive situations which can only be interpreted in quantum terms by using ψ and $|\psi\rangle$, namely particle interference (3/6) and Stern-Gerlach experiments (1/6). Nevertheless, all students included among exclusively quantum context microscopic scale systems, such as atoms and molecules, whose properties can be partly accounted for also by classical or semi-classical quantized models. Thus, they evidenced a difficulty in looking at a context from multiple theoretical perspectives at the same time. (RQ1).

The awareness of quantum interference showed in I1 was not transposed in the application context of specific problems concerning quantum interference (item I3). The physical role of phase difference, closely tied to this process, was not evidenced neither in the context of Stern-Gerlach experiment, nor in a situation

concerning observables with continuous spectra. Students handled vector coefficients as positive real numbers, and interpreted $\psi(x)$ and $|\psi(x)|^2$ as different ways to convey the same physical information (RQ2).

Basis change is a fundamental tool of QM, providing the derivation of predictions on measurement of observables non-commuting with that on whose basis the state is developed. While not using phases in their answer, 2/6 students consistently interpreted base change equations in item I3. The other ones, either interpreted the relations of basis change as providing information on the state of system under test, or did not take them into account because they handled measurements on different spin components as the same physical situation, thus showing difficulties with incompatibility and the operator structure of observables (RQ3).

Students generally identified conditions ψ has to satisfy in order to represent a physical system, both in formal expressions and in graphs, and developed a sense for excluding pathological functions. Nevertheless, the representational issues elude them: except for boundary conditions, requirements for valid ψ are mostly memorized facts, justified neither on a mathematical level, nor on a physical one (RQ4).

Discussing quantum concepts on a qualitative-cultural level and, separately, by means of an abstract problem solving may not be sufficient for building consistent mental models of quantum concepts. There is a need to explicitly address the translation process between mathematics and physical meaning in teaching, discussing the structural role of quantum state formalism in the theory, introducing tasks and instructional material devised to build an awareness of the way in which information is encoded in the formal representations of quantum state.

References

- Bub, J. (1999). *Interpreting the Quantum World*, Cambridge University Press, Cambridge, UK.
- Bucy, B., Thompson, J., and Mountcastle, D. (2006). Student (mis)application of partial differentiation to material properties. *Proceeding of Physics Education Research Conference 2006*, American Institute of Physics.
- Caballero M.D., Wilcox, B. R., Doughty, L. and Pollock, S. J. (2014). Unpacking students' use of mathematics in upper-division physics. *Submitted for publication to Physical Review Special Topics - Physics Education Research*. Retrieved at: <http://arxiv.org/abs/1409.7660>
- Johnston, I. D., Crawford, K., and Fletcher, P. R. (1998). Student difficulties in learning quantum mechanics, *International Journal of Science Education*, **20**(4), 427–446.
- Karam, R. (2014). Framing the structural role of mathematics in physics lectures: a case study on electromagnetism, *Physical Review Special Topics - Physics Education Research*, **10**, 010119.
- Levi, A. (2006). *Applied Quantum Mechanics*, Cambridge University Press, Cambridge, UK.
- Loverude, M. E. (2009). Student understanding of basic probability concepts in an upper-division thermal physics course. *Proceedings of Physics Education Research Conference 2009*, American Institute of Physics.
- Lumbelli L. (1997), Gestalt theory and C. Rogers' interviewee-centered interview - Das Werden of the interview climate, *Gestalt Theory*, **19**, 92–99.
- Pepper, R. E., Chasteen, S.V., Pollock S. J., and Perkins, K. K. (2012). Observations on student difficulties with mathematics in upper division electricity and magnetism, *Physical Review Special Topics - Physics Education Research*, **8**, 010111.
- Robertson, E., and Kohnle, A. (2010). Testing the Development of Student Conceptual Understanding of Quantum Mechanics. *Proceeding of GIREP-EPEC & PHEC 2009 Conference*.
- Thompson, J., Bucy, B., and Mountcastle, D. (2005). Assessing student understanding of partial derivatives in thermodynamics. *Proceedings of Physics Education Research Conference 2005*, American Institute of Physics.
- Singh, C. (2008). Student understanding of quantum mechanics at the beginning of graduate instruction, *American Journal of Physics*, **76**(3), 277–287.
- Singh, C., Belloni, M., and Christian, W. (2006). Improving Student Understanding of Quantum Mechanics, *Physics Today* (August), 43–49.

- Uhden, O., Karam, R., Pietrocola, M., and Pospiech, G. (2012). Modelling mathematical reasoning in physics education, *Science & Education*, **21**(4), 485-506.
- Wilcox, B. R., Caballero, M. D., Rehn, D. A., Pollock, S. J. (2013). Analytic framework for students' use of mathematics in upper-division physics. *Physical Review Special Topics - Physics Education Research*, **9**, 020119.
- Wittmann, M. C., Morgan, J. T., and Bao, L. (2005). Addressing student models of energy loss in quantum tunneling, *European Journal of Physics*, **26**(6), 939–950.
- Zuccarini, G. (2014). Physics student ideas on quantum state and its formal representations, *Il Nuovo Cimento C*, **37**(4), 273-283.

Affiliation and address information

Marisa Michelini; Giacomo Zuccarini
Physics Education Research Unit
Department of Chemistry, Physics and Environment,
University of Udine
Viale delle Scienze, 206
33100 Udine, UD
Italy
e-mail: marisa.michelini@uniud.it ; giacomo.zuccarini@uniud.it

Chapter 5
ICT and Multi-Media in Physics Education

Operating System Independent Physics Simulations

Oswaldo Aquines, Héctor González, Pablo Pérez

Universidad de Monterrey (Mexico)

Abstract

In his research on the cognitive development, Jerome Bruner^j proposed three modes of representation: Enactive representation (action-based), Iconic representation (image-based) and Symbolic representation (language-based). These modes occur sequentially in the natural learning process. The Enactive representation is particularly important since it implies many senses. In the context of physics the Enactive representation would be the direct interaction with the phenomena, namely a laboratory. Unfortunately, in most physics courses due to classroom size, time, budget, etc. the course is centered in the development of the theory and solving equations (covering mostly the Iconic and Symbolic representation) and if there is a laboratory, it occurs at a different time and place. By this the student gets in a highly abstract reasoning process without a physical reference to relate it. Computer based physics simulations offer the teaching process the opportunity to integrate the three modes of representation in the same classroom session, providing a more solid and integral learning process for the student. Nevertheless, nowadays there are many types of computing devices and several operating systems, and most of the actual simulations are operating system dependent and require specific libraries. These requirements limit their use to a certain type of devices and platforms. The offered complimentary alternative is a set of Java coded cross-platform physics simulations which can be used in any computing device on any the available operating systems: from personal computers, tablets and smartphones on Linux, Windows, iOS or Android. They enable the student to interact with the desired phenomena at all times and places. Learning games and challenging scenarios can be proposed and left as homework, since the simulations can be accessed continuously and by this engaging the student in the development of knowledge. Since they help him become the center and administrator of his own learning process, they contribute to active learning and knowledge ownership. As well, making the interaction with the phenomena more persistent, a deeper insight of the concept is reached. This cost effective cognitive tools are intended to fulfill the needs of the modern education system from elementary to college level. They can be used for illustrative purposes or to predict results using theory.

Keywords

Physics Simulations, JavaScript, Virtual laboratory, Cognitive tools

1. Introduction

The traditional teaching of Physics is mostly based in the lecture by the teacher. It is primordially focused in stating physics laws with their respective formulas and afterwards solving exercises in the abstract level leaving behind the association with the phenomenon that is described by the physics principles. This delay in the association is quite serious because in a natural learning process, the interaction with the phenomenon is the fundamental component and it should be the first to happen, as told by Jerome Bruner [1] in his research on the cognitive development. In some cases, the interaction with the phenomenon takes place in a laboratory, but having the disadvantage of happening in different time and space from the development of theory leaving again association behind. Furthermore, physics laboratories are expensive and limited to very specific scenarios, so not all of the theory can be associated with the actual described phenomena.

To address this issue, computer simulations have been developed and have shown great success in helping students visualize physical phenomena and associate it with the theory. Nevertheless the actual options [2,3] are limited to certain computing devices and require the use of specific libraries, limiting their use to certain spaces and occasions. Nowadays there are many types of devices and operating systems, and to be more effective, learning strategies should be accessible in all that range of computing options. The proposed alternative is a set of Java coded cross-platform physics simulations. These simulations are contained in the Newtondreams project (www.newtondreams.com) developed in the Physics and Mathematics Department at

Universidad de Monterrey. Since they are operating system independent and do not require any specific libraries, they can be accessed by students anywhere at any time in their smartphones, tablets, computers, etc. The intention is to provide open access cognitive tools to help the student to get deeply involved with the simulated phenomena. These tools are meant to be used in learning activities to provide effective learning strategies. In the words of Jonassenⁱⁱ: “Cognitive tools, if properly conceived and executed, should activate cognitive and metacognitive learning strategies”.

In section 2 we will describe how physics simulations help to follow a natural learning processⁱ in physics courses. We will then proceed to section 3 discussing how physics simulations can be efficient cognitive tools. Finally on section 4 we will talk about why physics simulations should be operating system independent in the present era.

2. Physics simulations and the natural learning process

In a natural learning process (as described by Bruner [1]) three modes of representation should happen sequentially: First, the physical interaction (Enactive), secondly representation or association with images (Iconic), and finally the description using language (Symbolic). In traditional physics courses the transfer of knowledge relies mostly in the Iconic (stating physics laws and using their respective equations) and Symbolic (diagrams) modes, and leaving the Enactive (a laboratory) afterwards in a different time and space. As an example, we will use parabolic motion of projectiles. In a regular course the session starts by showing that the only active force on the projectile is due to gravity \mathbf{g} that acts in the vertical axis. That is why its vertical movement is accelerated (according to Newton’s second law). Then, remembering Newton’s law of inertia, a body should continue in constant movement if no external force is acting on it, that is why the horizontal movement is constant, which in a physics course is normally stated as $V_x = \text{constant}$. Then the main equations of parabolic motion are defined:

$$\begin{aligned} y &= y_o + v_{oy}t - \frac{1}{2}gt^2 \\ x &= v_{ox}t \\ v_y &= v_{oy} - gt \end{aligned} \tag{1}$$

Later on, a set of exercises are solved using the equations obtaining, maximum height, horizontal displacement, time of flight, etc. This classical approach usually leaves the association with the phenomena behind. Students rarely get to visualize the change in velocity on the vertical component versus the constant movement in the horizontal. A highly abstract reasoning process should be followed by the student to be able to relate the content seen in the classroom with actual projectile motion.

It is here where physics simulations help to follow a natural learning process. Using a different approach, the classroom session may start directly interacting with the simulated phenomenon. Figure 1 shows a parabolic motion simulation which has three main input parameters: Initial height, speed and angle. The student, with guidance from the teacher, proceeds to experiment what happens if the initial speed is larger, what happens at different angles, etc. The simulation shows the vertical and horizontal components of the object’s velocity at every moment. In such way the student can visualize that the horizontal component stays the same, and then he can infer that horizontal motion is constant. On the other hand it is observable how the vertical component of the velocity is changing, illustrating the student how unlike horizontal motion, vertical motion is accelerated. Using this approach, the interaction with the phenomenon gives the student the chance to develop a more profound knowledge of it and it gives a solid basis to proceed later with the development of theory and solution of numerical exercises.



Figure 1. Computer simulation of parabolic projectile motion for using an initial velocity $v_0=35$ m/s and an angle $\theta=66^\circ$ respect to the horizontal axis. The horizontal and vertical components at different times are shown to illustrate the difference between vertical (accelerated) and horizontal (constant) motion. The image is superimposed to show the evolution of the movement.

2. Physics simulations as cognitive tools

Physics simulations can be powerful cognitive tools (as described by Jonassen [4]) with the proper execution. For this purpose we can design a learning strategy based on the generation of new knowledge departing with the individual's actual conceptions. Both Piaget [5] with schemas and Wittrock [6] with generative processing state that during the learning process, the individual associates new information relating it with previous knowledge.

As an example let's take periodic motion using the harmonic oscillator, particularly, the spring mass system. To reach the students prior knowledge, the teacher may start with trigger questions to refresh the student's knowledge of Hooke's law (or simply the behavior of a spring):

- What do you think that would happen if you hang the mass from the spring?
- What will happen if you now hang a larger mass? Should the spring stretch the same, more, less?

Afterwards, the student can check his predictions using the simulation (Figure 2) and compare results. With guidance from the teacher, the student can infer or simply remember Hooke's law.

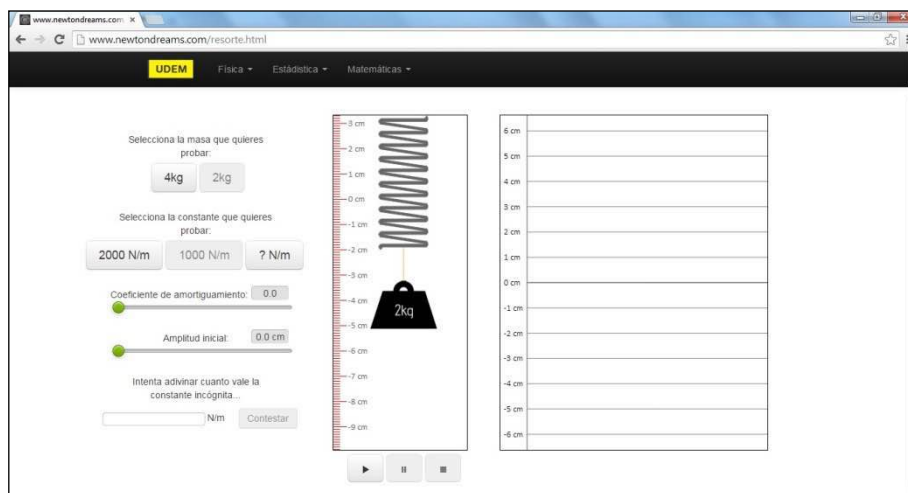

Figure 2. Computer simulation of a mass-spring system showing the stretch of a $k=1000$ N/m spring caused by a 2kg mass hanging on it. The mass of the spring is neglected.

After that, the student can proceed to take the mass away from equilibrium, the teacher can now ask:

- What would happen now if you stretch the mass-spring system from its equilibrium position? Does the string stay the same? How does it react to this modification?
- What will happen if you now release the mass spring system from the stretched position? Does it stay there? Does it return calmly to the equilibrium position? How far will it move?
- After releasing it, will it ever return to the stretched position?

Again, with the guidance of the teacher, the student may foresee the effect of the restorative force of the spring. In best case scenarios, the student might already realize that the motion is repetitive. Then, the student can proceed observe the actual phenomenon with aid of the simulator (Figure 3):

- Release the mass-spring system from the stretched position and let it move
- It is returning to its departure point?
- Let it oscillate for a while; observe how long does it take to return to its departure point. Does it always take the same time to go back and forth?

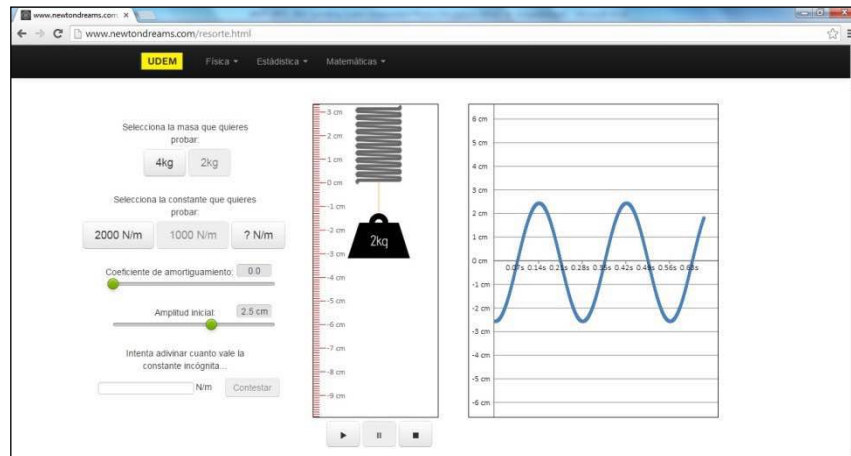

Figure 3. Computer simulation showing oscillations of a 2kg mass on a $k=1000\text{N/m}$ spring. The illustrated amplitude is 2.5cm.

At this point the teacher can introduce the concept of periodicity and define the period as the time it takes to complete one full oscillation and state that it is constant. To reinforce, the teacher can help the student relate the concept with other repetitive processes in daily life which have a defined cycle and period: The hours of the day, the newspaper delivery, etc.

2. Why do physics simulations need to be operating system independent?

The actual physics simulations projects [2,3] contain mainly applications for PC's (Personal Computers) which require specific libraries. Actually, there are each time less PC users and more tablet and smartphone users. The Gartner [7] company reported that in 2013 2.3 million of ultra-mobile devices (tablets smartphones and else) and only 0.3 million PC's. Cross-platform simulations extend the reach of learning strategies by making the cognitive tools accessible to a wider audience. Traditionally in a course session, tablets and smartphones are tagged as distractors, now we can take advantage of them by integrating them in learning process (Figure 4)



Figure 4. Students using operating system independent physics simulations on several computing devices. For this particular case, the mass spring system simulation is shown.

The operating system independent simulations contained in the newtondreams project are programmed in HTML/JavaScript. Since HTML/JavaScript is embedded in all web browsers, these simulations do not have any special requirements and can be run in any operating system independently of its type and release. They are open access and since they are programmed with basic libraries. Therefore, the student can profit from them at any time and place increasing his interaction with the simulated phenomena. Learning scenarios can be designed for the classroom session or homework.

References

- [1] Bruner, J. (1976). *The Process of Education*, Harvard University Press
- [2] ComPADRE Resources and Services for Physics Education, <http://www.compadre.org/>
- [3] PhET Interactive Simulations, <https://phet.colorado.edu/>
- [4] Jonassen, D.H., (1978). What are cognitive tools?. In (1992) Piet A.M. Kommers, David H. Jonassen & J. Terry Mayes *Cognitive tools for learning*, NATO ASI series, Series F: Computer and Systems Science, Vol. 81. SpringerVerlag.
- [5] Piaget, J. & Inhelder, B. (1969). *The psychology of the child* (H. Weaver, Trans). New York, Basic Books
- [6] Wittrock, M. C. (1974). Learning as a generative process. *Educational Psychologist*, 11
- [7] Gartner, D.H., (July 7, 2014). Gartner Says Worldwide Traditional PC, Tablet, Ultramobile and Mobile Phone, <http://www.gartner.com/newsroom/id/2791017>

Affiliation and address information

Oswaldo Aquines, Hector Gonzalez, Pablo Perez
Department of Physics and Mathematics
Universidad de Monterrey
Av Morones Prieto 4500 Pte.
San Pedro Garza García N.L.
C.P. 66238, Mexico
e-mail: osvaldo.aquines@udem.edu
hector.gonzalezf@udem.edu
pabloperz_92@hotmail.com

Interactive Whiteboard (IWB) and Classroom Response System (CRS): how can teachers integrate these resources in physics experimental activities?

Assunta Bonanno¹, Giacomo Bozzo¹, Federica Napoli², Peppino Sapia¹

¹ PER Group, DiBEST Department, University of Calabria, 87036 Arcavacata di Rende (CS), Italy

² Graduate Student - Physics Department, University of Calabria, 87036 Arcavacata di Rende (CS), Italy

Abstract

In the last three decades, international literature showed that students have to face and overcome many difficulties in order to reach a deep comprehension of basic physics laws (even though they are often related to everyday life phenomena). In particular, teachers have to consider learners' difficulties connected to graphical representation of physics quantities (e.g. space vs time and velocity vs time graphs) associated to uniform linear and uniformly accelerated motions (McDermott 1993).

In order to help students facing these difficulties, innovative learning paths based on information and communications technologies (ICTs) and real-time experiments play a crucial role. In fact, international literature demonstrated the advantages of using new technologies in conjunction with laboratorial activities, as regards students' engagement and skills' development. A wide literature showed that ICTs can be used as "cognitive tools" as well as instructional media (Cogill 2002). Interactive White Board (IWB) is an example of these cognitive tools, that allows teachers to plan innovative learning activities, integrating real experiments with a wide range of ICTs resources. In addition to IWB activities, many researches demonstrated that the use of Classroom Response System (CRS) with appropriate set of questions improves classroom dynamics and interactivity (Beatty et al. 2006).

In this paper we present an experimental learning path on linear motion and on uniformly accelerated motion, combining IWB practices, real experiments and video-analysis (by using Tracker free software) with CRS activities. We planned our learning path in order to address (in particular) students' difficulties related to graphical representations, by using different ICTs activities (i.e. IWB practices, video-analysis of real experiments and Multi-Choice response activities through CRS).

We involved a sample of third-year science education students (University of Calabria). The obtained results lead to interesting conclusions, regarding engagement of students and improvement of their skills. In particular, the comparison between pre and post-test results shows that our learning path helps students to improve their abilities regarding graphical representation and analysis of physics quantities related to linear motion and to uniformly accelerated motion.

Key Words:

Physics Education, IWB activities, CRS, ICTs technologies, Artefacts, Kinematics, Linear Motion, Graphical representation, Real Experiments, Video-Analysis.

1. Introduction and Objectives

Over the past three decades international literature showed advantages of using computer and ICT technologies as additional value to teach physics¹. A wide literature showed that ICTs can be used as "cognitive tools" as well as instructional media, employing integrated or mobile devices and different easy-to-use software. Interactive White Board (IWB) represents an example of this kind of technologies, that allows teachers to plan and to propose students' centred activities if integrated in laboratorial practices (Bozzo et al. 2014). Different studies demonstrated the advantages introduced by IWB in educational activities, since it allows students to become active players in teaching and learning processes (Murcia 2008; Hennessy et al. 2007). Moreover, IWB helps teachers to involve the whole class and stimulates group

¹ International literature showed the advantages of using new technologies in education, as regards students' engagement and skills' development; for examples, see (Hogarth et al. 2006).

discussions among students or between learners and teacher (Hennessy et al. 2007), enhancing interactions between students and collaborative works (Bozzo et al. 2014): in this perspective, IWB “opens up new opportunities for learners and teachers publicly to express, explain, justify, evaluate, and reformulate ideas – both orally and using other rich symbolic representations” (Hennessy et al. 2007). Among different advantages introduced by employing interactive whiteboard in education, it allows interacting with different software (Murcia, 2008) and devices, like (for example) Classroom Response System (CRS) that offers teachers the possibility to perform in real-time evaluations of students’ answers, during classroom activities. Different studies demonstrated that CRS (through appropriate set of questions) improves classroom dynamics and enhances interactions between students and teachers (Reay et al. 2005). In fact, CRS activities allows teachers to follow in real-time students comprehension during a classroom activities (Reay et al. 2005) and to analyse the response of all students rather than a single answer (this aspect could be useful in particular in university lectures where the students overcome the number of 40-50 people).

Although many studies were performed to investigate the impact of IWB and CRS on teaching and learning processes, in the state of the art there is a lack of examples as regard IWB employments in science laboratory contexts (Bozzo et al. 2014). Moreover, though several studies showed the advantages of activity with CRS to address different physical concepts, no educational study (as we know) were proposed, using such instruments, with the aim of addressing the basic principles of the kinematics, like uniform linear motion and uniformly accelerated motion².

In this context, we planned an experimental learning path in order to study the benefits introduced by the employment of IWB and CRS in science laboratory (in which are performed also real-time laboratorial activities³). In particular, we designed a set of activities with the aim of facing some specific difficulties that students encounter approaching to physics laws or phenomena, like rectilinear motion of bodies with constant speed or acceleration. In fact, several studies demonstrated different difficulties of students in this area of physics, though it involves many phenomena of everyday life experiences. In particular, some researches showed students’ difficulties regarding the graphical representation of physics quantities involved in the motion of bodies, like velocity or acceleration graphics as functions of time (Trumper & Gelbman 2002; Beichner 1996).

In order to address this specific goal, we decided to integrate IWB and CRS activities with video motion analysis (using the free software⁴ Tracker[®]), since it allows to examine an event and its graph simultaneously rather than sequentially (Beichner 1995) and, for this reason, it can improve kinematics graph interpretation skills (Beichner 1996).

The paper is organized as follows. In section 2, we describe the context and the experimental learning path, in section 3 we discuss the analysis of data and in Section 4 we remark the implications of this work.

We planned these activities in order to answer the following *Research Questions*:

RQ1: Which contributions does our leaning path give in terms of students’ comprehension of physics concepts related to the motion of bodies?

RQ2: Which contributions does our leaning path give in terms of students’ graphical representation skills of physics quantities related to the motion of bodies?

2. Experimental learning path

We proposed our Experimental Learning Path to third year students of Bachelor's degree in Primary Education (University of Calabria), involving 67 future teachers in primary schools. All of them studied physics in high schools (before the university studies) and took the graduate math course before starting our learning path.

We employed 3 sessions (about 3 hours each one) in order to address different concepts related to the motion of bodies. In particular, we planned our work with the aim of analysing in which way IWB and CRS (integrated in an experimental learning path) help future primary school teachers to improve their abilities regarding graphs representation and analysis (in two specific cases: uniform linear motion and uniformly accelerated motion).

² Some examples of CRS uses in educational (regarding kinematics) were proposed to analyse the parabolic motion, see for example (Beatty et al. 2006).

³ Many studies demonstrated the advantages introduced by real-time laboratories, since they allow students to follow in real time the evolution of phenomena (Gervasio & Michelini 2006; Bonanno et al. 2011), to make very accurate measurements of various physics phenomena (Michelini 2007; Sokoloff et al. 2007) and to facilitate correlations between the time evolution of the process and involved physics quantities (Michelini 2007).

⁴ <http://www.cabrillo.edu/~dbrown/tracker/>.

Our learning path has been divided in 8 parts:

- **Step-1:** Open response pre-test (40 minutes);
- **Step-2:** Multi-choice pre-test through Classroom Response System (40 minutes);
- **Step-3:** Introduction of concepts related to linear motions, using different animations (40 minutes);
- **Step-4:** Real experiment about linear motions (60 minutes);
- **Step-5:** Video analysis of a walking student and of a free fall body (180 minutes);
- **Step-6:** In-depth activities through CRS (60 minutes);
- **Step-7:** Multi-choice post-test through Classroom Response System (40 minutes);
- **Step-8:** Open response post-test (40 minutes).

Step-1 & Step-8: Open response pre and post test

We proposed at the beginning of this work a set of open response questions, aimed to investigate students' previous ideas about uniform linear motion and uniformly accelerated motion (*Step-1*). In this first step, learners observed and described the real movement of a steel ball on a wooden guide (*a ramp*, composed by an inclined and an horizontal plane, see *Figure 1*), without teacher's description or introduction. This first analysis allowed us to explore their spontaneous ideas regarding two important motions, in order to check their previous knowledge about the related physics concepts. In particular, this test permitted us to investigate students' ideas about ball's motion on inclined plane (i.e. uniformly accelerated motion) and on the horizontal plane (i.e. uniform linear motion if students neglect friction force, uniformly decelerated motion if they consider the action of friction force⁵).

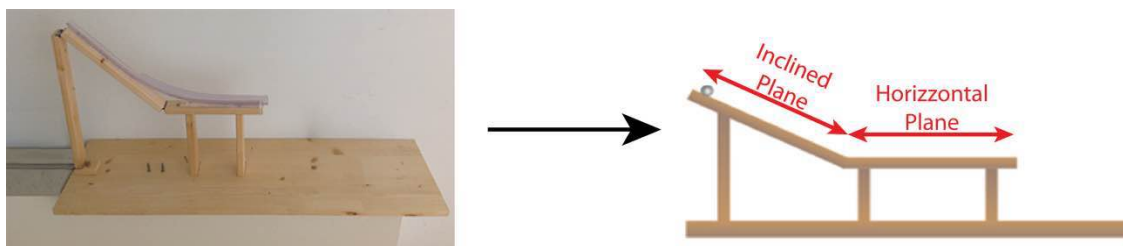

Figure 1: The picture shows a photo of the artefact used to carry out the open-responses in the pre and post-test (left figure); The artefact is composed by an inclined and an horizontal plane, on which a steel ball can move (right figure).

In details, students observed the motion of a little steel sphere along the ramp and answered 5 questions, in order to describe the observed phenomenon.

We proposed the same questions also at the end of our learning path, in order to compare learners' answers after our experimental activities with their previous ideas (*Step-8*).

Step-2 & Step-7: Multi choice pre and post-test (using CRS)

The second step allowed us to investigate both students' previous ideas regarding the relationship between space and time and their graphical-representation skills of observed phenomena. In details, we proposed a multi-choice pre-test employing Classroom Response System (CRS) in order to analyse students' ideas about the relationship between the distance covered by the steel ball and the corresponding time, both for the inclined and horizontal part of the ramp (*Figure 2* shows the questions proposed to the classroom).

Also in this case, students answered the same questions at the end of our learning path (before the open-answers post-test), in order to make a comparison with their answers given at the beginning of the activities (*Step-7*).

Step-3: Introduction of concepts related to linear motions, through animations

In this step, Learners reproduced the ball's motion along the ramp by using the interactive educational software⁶ Algodoo®, which allowed them to visualize on IWB the physics phenomenon observed at the beginning of our learning path. After this first animation, we introduced the motions of a body with constant

⁵ We proposed the ramp in order to stimulate students reflections about the uniform linear motion on the horizontal plane, considering the small dimensions of the steel ball, and the small length of the horizontal plane that does not allow observing a deceleration of the ball.

⁶ The software can be downloaded from: <http://www.algodoo.com/>.

speed or acceleration by using two different animation available on internet⁷. The first one allowed students to visualize qualitatively the concept of distance covered by a body when it moves with different laws of motion. The second offered learners the possibility to understand the meaning of generic “distance vs time” graph and in which way it can be constructed.

Step-4 & Step-5: Real experiments about uniform linear motion and uniformly accelerated motion.

After the introduction previously described, we proposed to students three real experiments, that offer them the possibility to analyse in depth the motion of a body with constant speed or acceleration.

In the first experiment (*Step-4*), students measured the distances covered by 5 pedestrian motions (we asked to five of them to walk approximately with constant speed); then, they plotted on an Excel sheet the distances covered versus the time employed. This simple experiment allowed students to construct the typical graph of a pedestrian that moves with a constant speed. Moreover, it offered them the possibility to understand that the angular coefficient (of obtained linear relationships) represents the speed of each pedestrian, since students remembered who was walking quickly or slowly.

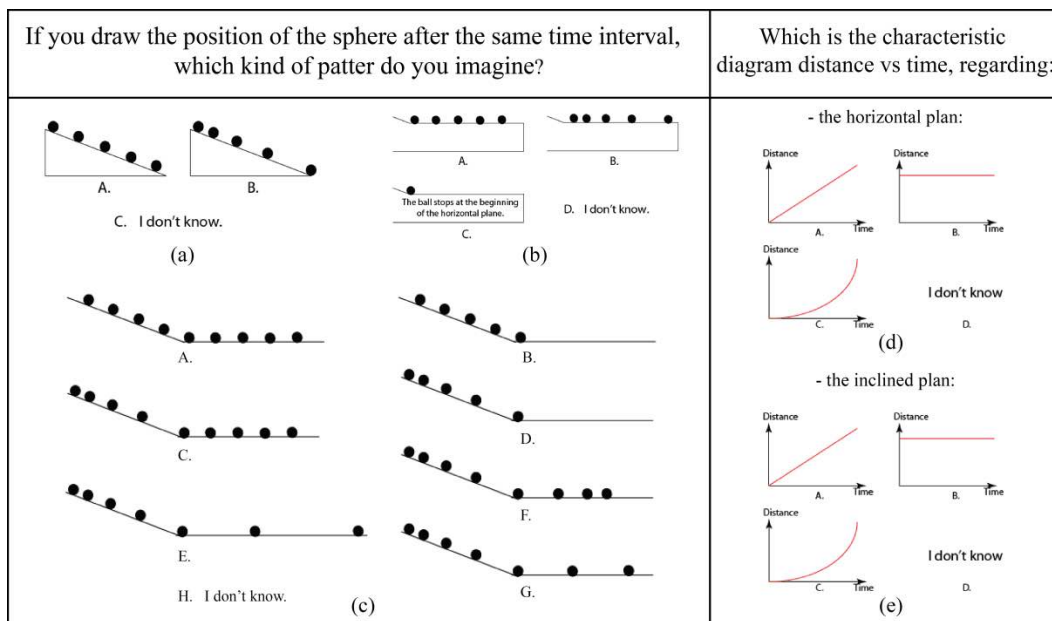

Figure 2: The multi-choice pre and post-test questions aim to investigate students’ ideas about the relationship between the distance covered by the steal ball and the corresponding time, in the case of the inclined plane (a), the horizontal plan (b) and the whole ramp (c). The last two questions aim to study students’ ideas about the typical distance vs time graphs, in the case of the horizontal plan (d) and the inclined plane (e).

In the *Step-5*, learners performed the video-analysis of a pedestrian movement and of a free-fall object (recorded through a smartphone), employing the well-known (Java-based) tool Tracker⁸, in order both to obtain the same results of *Step-4* regarding the pedestrian motion, and to construct the typical graphics of a uniformly accelerated motion. The *Figure 3* shows the video-analysis of rectilinear motions with constant speed or acceleration.

All the results obtained by small group of students were displayed and analysed through the interactive whiteboard (using work-stations management software), stimulating in this way the discussions between students or between teacher and students. Moreover, IWB allowed us to demonstrate (through drag and drop actions) that the obtained linear relationships *distance vs time* imply that the ratio between the variation of distance and the corresponding variation of time is constant with respect to time (i.e. it represents a motion with constant speed). In a similar way, we demonstrated (from a qualitatively point of view) that a quadratic relationship between distance and time implies a motion with constant acceleration.

⁷ First animation: <http://www.stmary.ws/highschool/physics/home/animations3/motion2.html>;

Second Animation: http://www.stmary.ws/highschool/physics/home/animations3/motion_graphs2.html.

⁸ <http://www.cabrillo.edu/~dbrown/tracker/>.

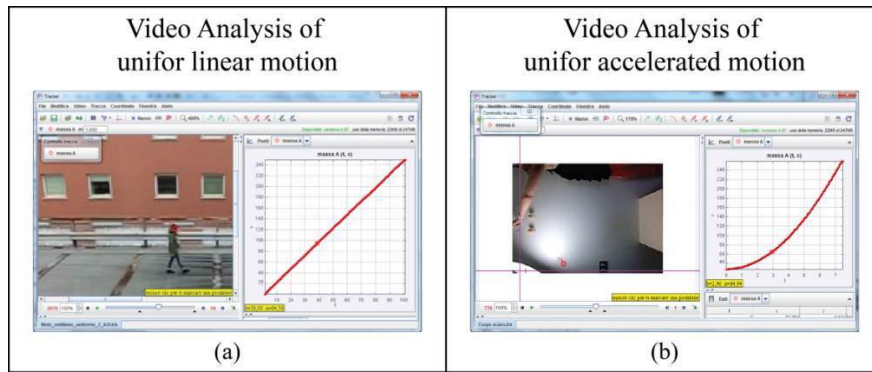

Figure 3: (a) Video analysis of a uniform linear motion; (b) Video Analysis of uniformly accelerated motion.

Step-6: In-depth activities through Classroom Response System (CRS).

We planned these test in order to investigate students’ comprehension about linear motion with constant speed or acceleration and to analyse in which way IWB and CRS help them to understand the graphical representation of different physics quantities (*distance vs time, velocity vs time and acceleration vs time*). In fact, we asked students to analyse various graphical representations, that were different from the situations proposed during pre-test and video-analysis activities. This choice gave us the possibility to use again pre-test questions at the end of our learning path, in order to compare students’ previous knowledge and graphical representation skills with the outcomes after this work.

The 18 qualitative and quantitative questions were planned introducing progressive difficulties with the aim of analysing as much as possible the graphical features of uniform linear motion and uniformly accelerated motion (the Figure 4 represents some of the multi-choice test that we proposed to students).

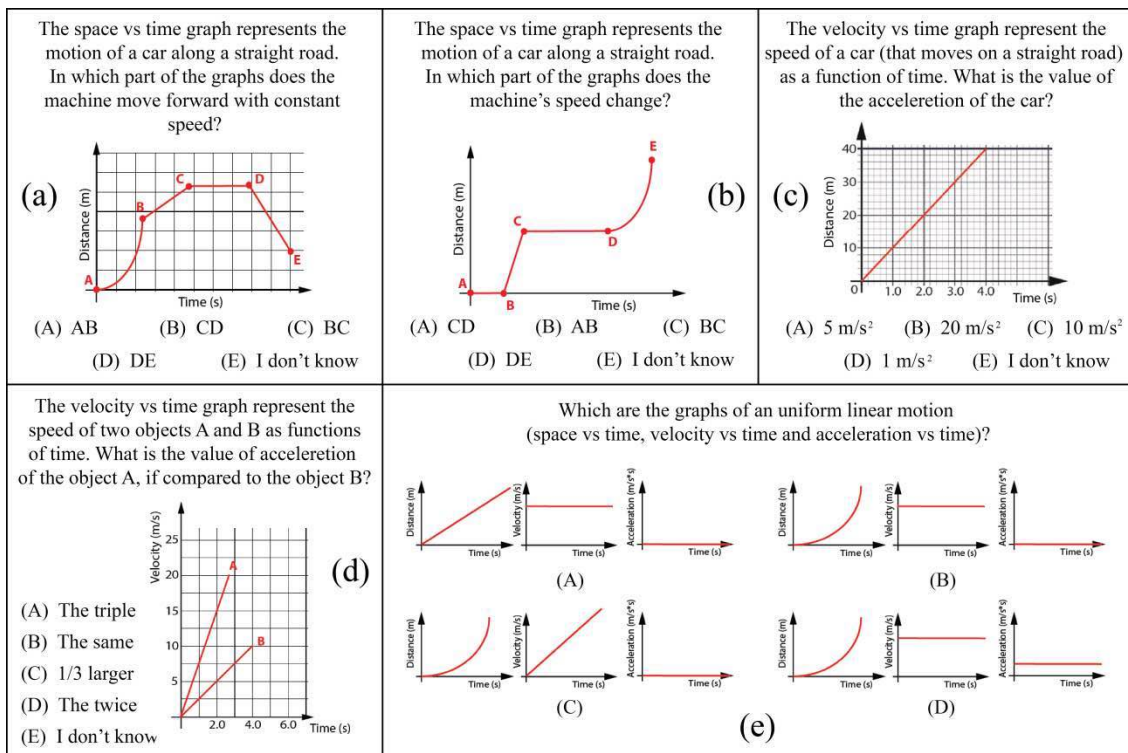

Figure 4: Some of the multi-choice questions proposed to students: figures (a) and (b) show two examples of qualitative investigations; pictures (c) and (d) show two examples of quantitative calculations; figure (e) shows an example of question that combine different representations.

The activities performed using CRS stimulated students’ involvement during the session, encouraged the comparison of ideas after each question and stimulated very interesting brainstorming, during the analysis of

students' answers (since it offered the possibility to visualize on the IWB the results of their answers in real time).

3. Results and Discussions

In this paper we tried to investigate the impact of IWB and CRS on graduate students (prospective teacher in primary school), regarding their ideas about basic physics concepts and their graphical representation skills related to bodies' motion (i.e. to the basic topics of kinematics laws). Our data analysis can be divided in three parts: **(i)** the first regard the investigation of students' ideas about basic physics concepts; **(ii)** the second gives the possibility to compare learners' schemes about the relationship between distance and time; **(iii)** the last offers the possibility to study in which way the activities performed using classroom response system influence learners' graphical representation analysis.

3.1 Comparison between pre-test and post-test open-response questions (RQ1)

The qualitative analysis of students' open-response answers in the pre-test and post-test activities allowed us to obtain the first outcomes of this study. We defined two dimensions of analysis, respectively related to the focus of students (during the observation of the ball's motion on the ramp) and to the contents that they used to describe the observed motion. The *Table 1* summarizes the categories that we defined during the iterative process of qualitative analysis (Miles et al. 2014).

Table 1. The Dimensions of Analysis (**D1**) *Students' Focus* and (**D2**) *Physics Contents* represent the first outcome of this work.

	Code	Name - Definition
D1	TEAC	Teacher: Students focus their attention on teacher rather than on the motion of the sphere.
	PHEN	Phenomenon: Students focus their attention on physics phenomenon.
D2	STR_gen	Generic Structure: Students describe guide structure (without details).
	STR_det	Detailed Structure: Students describe the guide structure (with particular details).
	MOT_gen	Generic Motion: Students observe the generic motion of the sphere.
	MOT_vel	Motion & Velocity: Students relate the sphere's motion with its velocity.
	MOT_hei	Motion & Height: Students relate the sphere's motion with its starting height.
	MOT_v&h	Motion & Velocity-Height: Students relate the sphere's velocity with its starting height.
	STR_MOT	Structure & Motion: Students describe the sphere motion after the structure's description.
	PHY_a&u	Physics Description: Students describe the sphere' motion in terms of physics concepts (constant accelerated motion on inclined guide and linear motion on horizontal guide).
	PHY_a&d	Physics Description: Students describe the sphere' motion in terms of physics concepts (constant accelerated motion on inclined guide and constant decelerated motion on horizontal guide).
	PHY_uni	Physics Description: Students describe the sphere' motion in terms of physics concepts (uniform motion on inclined guide).
PHY_acc	Physics Description: Students describe the sphere' motion in terms of physics concepts (constant accelerated motion on inclined guide and speed variation).	
PHY_gen	Physics Description: Students describe the sphere' motion in terms of generic physics concepts.	

A first interesting remark regards the focus of students, while observing the movement of a steal ball on the ramp. In fact, a not negligible number of students focus their attention to teacher's actions instead of describing the observed phenomenon, in particular in the pre-test activity (18% of pre-test answers and 7% the post-test). In these answers, teacher appears like "the main actor of the scene": "*teacher put on the desk a*

ramp”; “After placing on the desk a ramp, the teacher put on it a ball and asked us to describe its movement”; “teacher put a ball on a wooden guide; this ball moved on the guide and was stopped by another teacher”).

This analysis seems to indicate that some students “avoid” to answer proposed question, probably because they need to improve their knowledge or their (appropriate) language. This statement would need an in-depth analysis from the viewpoint of psychological studies, in order to understand the dynamics that lead students to such a choice. However, we will not face this kind of investigation, because it would bring far from the topics of this paper. Nevertheless, we can state that students’ mastery of language and contents represent a key element that causes this outcome, since the number of answers that are focused on teacher’s actions decreases after our learning path (the results in the following confirms this statement).

The analysis of open-answers shows interesting outcomes in terms of physics concepts introduced by students to describe the ball’s movement on the ramp. In particular, the pre-test open-question activity shows that students describe the movement of the ball in generic ways, without using appropriate descriptions in terms of physics quantities or concepts (*Figure 5*, sky blue colour). At the end of our learning path, students propose different descriptions in terms of physics quantities (*Figure 5*, violet colour), showing a positive impact of our activities on students’ language and knowledge. In fact, before our activities (i.e. in the pre-test activity), students’ describe the motion of the ball, focusing their attention on the structure (**STR** categories) or describing the generic movement that starts from the higher point of the inclined plane (**MOT_hei**) and in which the “velocity of the ball increases” (**MOT_vel**). Some students relate ball’s velocity at the end of the inclined plane with the starting height (**MOT_h&v**). In *Step-1*, only 4% of students describe the phenomenon in terms of generic physics concepts (“the ball moves along the guide, due to gravity force”, i.e. **PHY** category) or introducing the generic concept of uniform motion (“the ball moves along the inclined plane with a uniform motion”, i.e. **PHY_uni** category).

After our activities, students attention shifts from generic descriptions (of structure and/or generic movement) to explanations in terms of physics quantities or concepts (these changes in the descriptions confirms the statement above proposed, regarding students’ focus). In fact, at the end of our leaning path, learners describe the ball’s motion in terms of physics quantities, recognising in particular that along the inclined plane the ball moves with a uniformly accelerated motion. This is an interesting outcome of our work, since we never made any reference as regard the motion of a body on an inclined plane, during the whole learning path (in fact, we proposed the inclined plane as an artefact, at the beginning and at the end of our activities). In particular, most of students explain that “the ball moves along the inclined plane with a uniformly accelerated motion” (**PHY_acc** category), or that “the ball moves with an uniformly accelerated motion along the inclined plane and then it decelerates uniformly on the horizontal plane” (**PHY_dec** category).

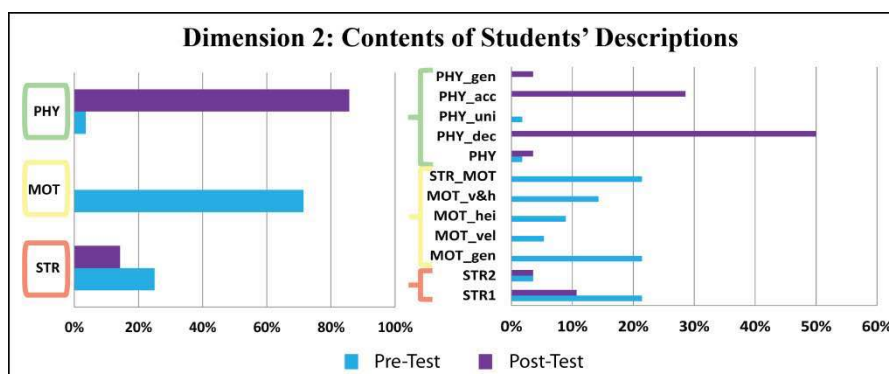

Figure 5. Analysis of D2 dimension: students’ descriptions of observed phenomenon, in terms of structure’s details (**STR**), of generic ball’s movement without references to physics concepts (**MOT**) and of physics quantities and concepts (**PHY**).

It is interesting to observe that, during the final brainstorming at the end of the learning path, many students motivated their descriptions regarding the motion along the horizontal plane in terms of decelerated motion (in open answers post-test, *Step-8*), explaining that they thought about a generic horizontal plane, without taking into account the dimensions of the specific ramp that was (“too small to let us appreciate a deceleration of the ball”).

3.2 Comparison between pre-test and post-test multi-choice response about the schemes of body motions (RQ1).

The analysis of the schemes that students use to describe the relationship between distance and time during the motion of a body adds interesting elements to the evaluation of our learning path. In fact, while open-question test offers the possibility to investigate students' ideas about the motion of the ball on the ramp (distinguishing between inclined and horizontal plane), the first three questions of multi-choice test (see *Figure 2a-b-c*), allow us to investigate which scheme is used by learners to describe the movement along an inclined or horizontal guide. The *Figure 6* shows comparisons between pre and post-test multi-choice students' answers.

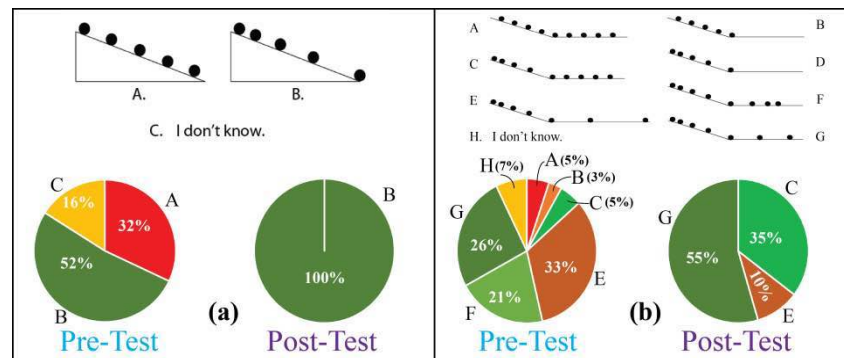

Figure 6. Multi-choice answers allow analysing the schemes used by learners to describe the ball's movement along an inclined or horizontal guide.

These comparisons show that students change their ideas about relationship between the distance covered by the ball and the time, since all of them choose the scheme of uniformly accelerated motion for inclined plane (*Figure 6a and 6b*) and most of them choose the scheme of uniform linear motion for horizontal plane (*Figure 6b*). This analysis indicates also that learners seem to be more familiar with the uniformly accelerated motion than the uniform linear motion. In fact, though 90% of learners propose the scheme that represents a motion along the horizontal plan with constant speed (answers C and G in *Figure 6b*), a number not negligible of them (35% of students) use the scheme C in which the velocity on the horizontal plan is not related to the motion at the end of the inclined plane: probably, they need to study in-depth the concept of velocity as ratio between space and time (*Figure 6b*).

Nevertheless, the comparison between pre and post multi-choice questions confirms the results analysed section 3.1 as regard students' description of ball's motion.

3.3 Analysis of activities performed through classroom response system (RQ2).

As regard the graphical representation, the comparison between pre-test and post-test shows that students increased their familiarity with graphical representations. In fact, if we compare the outcomes of the progressive steps that we planned for our leaning path, we can observe that:

a) in *Step-2* (i.e. the analysis of pre-test multi-choice answers) a great number of students encountered different difficulties in the analysis of space vs time graphics, since only 27% of students recognize the right space vs time graph for the motion along the horizontal plane (*Figure 7a*) and only 47% identify the correct representation for the movement along the inclined plane (*Figure 7b*). These results become more significant if we compare them with the outcomes of the post-test, in which most of students correctly identifies the graphical representations for the analysed motions (i.e. on the horizontal and inclined planes).

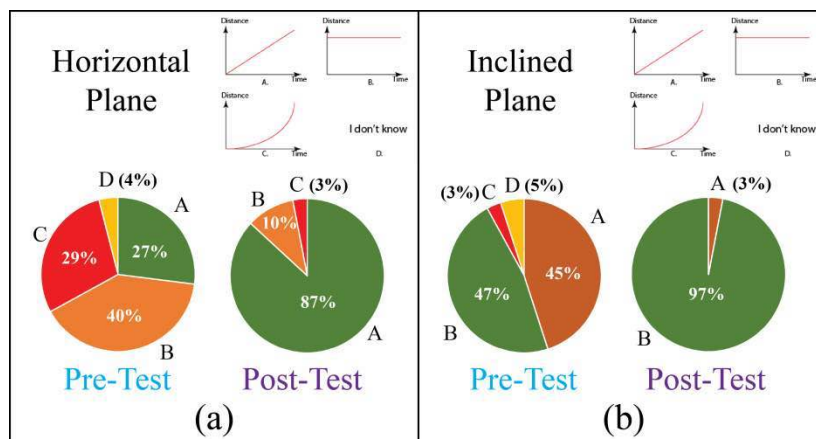

Figure 7. Multi-choice answers allow analysing the graphical representations used by learners to describe the ball's movement along an inclined or horizontal guide.

b) in *Step-5* (i.e. video-analysis of real motions with constant speed or acceleration) learners constructed the typical graphs of different physical quantities (i.e. space vs time, velocity vs time and acceleration vs time). This step allowed them to understand the graphical relationships that characterize both uniform linear motion and uniformly accelerated motions.

c) the *Step-6* (i.e. activities performed using classroom response system) confirms the findings above described, regarding the improvement of students' ability with graphical representations. In fact, CRS activities allowed us to show that students' developed important skills regarding the analysis of graphics. This result becomes more important if we take into account the abilities and the familiarity that students showed at the beginning of our experimental activity (as regard graphical representations).

In details, the analysis of multi-choice answers given by students during the in-depth activity confirms that they improve their abilities related to graphical representation of different physics quantities (during both the CRS activity and the whole learning path). In fact, the number of correct answers increases during the development of the in-depth activity with CRS, although the difficulties of proposed questions were increasing progressively (*Figure 8, Appendix A*).

In any case, this activity allows us to confirm that students improved their skill and familiarity with the analysis of graphics, since at the beginning of this work they encountered many difficulties to analyse simple and basic kinematics graphs.

4. Remarks and implications

Our research confirms some results of international literature about the use of CRS and IWB, since they allowed us to stimulate peer comparison and discussions (between small groups of students, as well as between students and teacher). In fact, IWB functionality of storing information (Bozzo et al. 2014) gave us the possibility to use experimental results (e.g. the graphics of motion obtained by students) in order to stimulate classroom discussions. On the other hand, CRS feature of giving students an immediate feedback (after each question) stimulated peer comparisons during the activities, since students compared their ideas after each answer, while analysing classroom results displayed in real-time on IWB.

Our learning path allowed to introduce specific physics concepts of kinematics, from a qualitative point of view. Students' open answers at the end of the activities show that they became more familiar with the basics concepts of kinematics, with respect to the pre-test outcomes.

Finally, this work demonstrates that the combination of real experiments, animations, video-analysis of real movements and CRS allows students to increase their familiarity with the basic concepts involved in bodies' motion, in particular regarding the space-time relationship in linear motions with constant speed or acceleration. In fact, video-analysis activities allowed students to construct the typical graphics of basic kinematics laws and to familiarize with the characteristic graphical representations of uniform linear motion and uniformly accelerated motion. On the other hand, the qualitative and quantitative multi-choice questions, proposed during the activities performed using classroom response system, stimulated students analysis of different graphical representations and allowed them to improve their skills about the interpretation of motion's graphs.

Appendix A

Figure 8 shows some examples of students' answers during the in-depth activity performed employing classroom response systems.

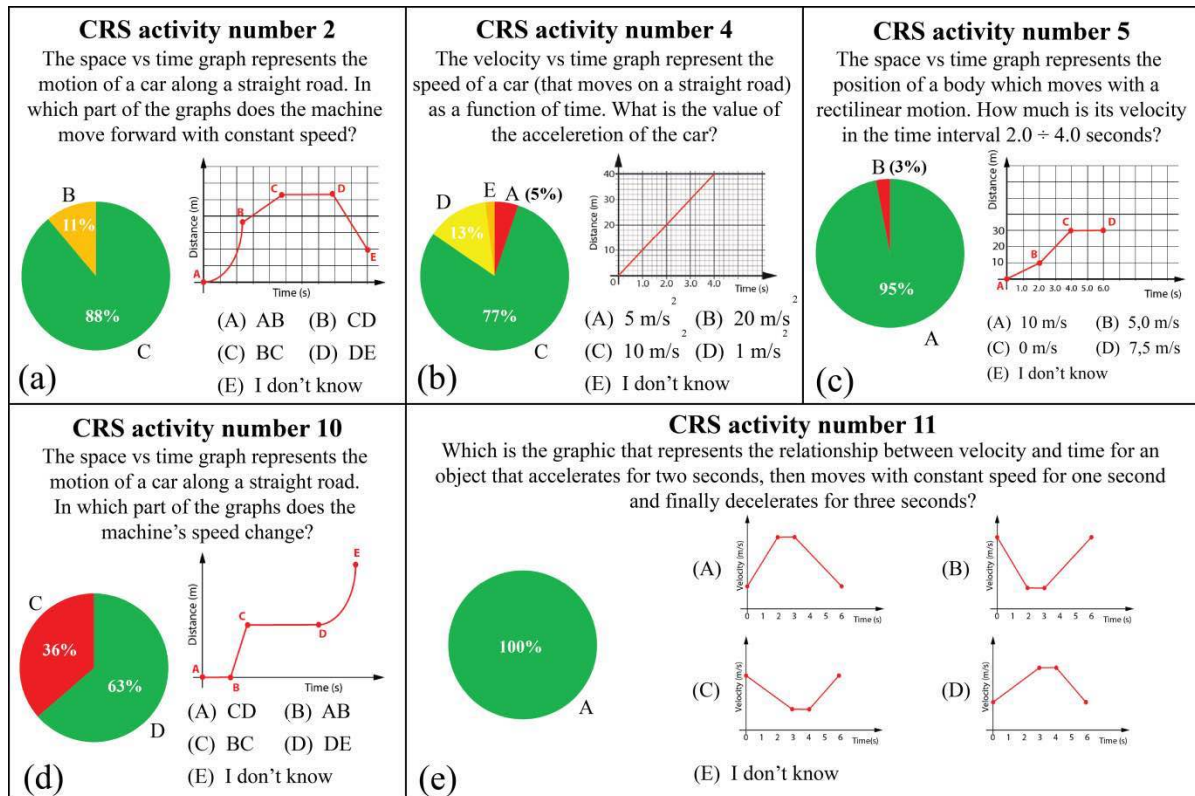

Figure 8. Multi-choice students' answer allow analysing the schemes used by learners to describe the ball's movement along an inclined or horizontal guide.

Acknowledgment

We would like to thank Roser Pintó (director of CRECIM, Autonomous University of Barcelona) for helpful discussions.

Part of this research was funded by ARUE Project of Calabria Region (Research Grant of European Union).



References

- Beatty, I.D., Gerace, W. J., Leonard, W. J. and Dufresne, R. J. (2006). Designing effective questions for classroom response system teaching. *American Journal of Physics*, **74**(1), p.31.
- Beichner, R.J. (1995). Considering Perception and Cognition in the Design of an Instructional Software Package. *Multimedia Tools and Applications*, **1**(2), pp.173–184.
- Beichner, R.J. (1996). The impact of video motion analysis on kinematics graph interpretation skills. *American Journal of Physics*, **64**(10), p.1272.
- Bonanno, A., Bozzo, G., Camarca, M. and Sapia, P. (2011). Using a PC and external media to quantitatively investigate electromagnetic induction. *Physics Education*, **46**(4), pp.385–394.

- Bozzo, G., Grimalt-Alvaro, C. and López, V. (2014). The uses of Interactive Whiteboard in a science laboratory. In *GIREP/MPTL international conference: Teaching/Leaning Physics: integrating research in to practice*. In press.
- Cogill, J. (2002). How is the interactive whiteboard being used in the primary school and how does this affect teachers and teaching. *IFS for EdD. London: King's College*.
- Gervasio, M. and Michelini, M. (2006). TERMOCRONO. Un semplice sistema economico e flessibile per misure di temperatura in tempo reale. *Didamatica 2006-Atti*, pp.522–529.
- Hennessy, S., Deaney, R., Ruthven, K. and Winterbottom, M. (2007). Pedagogical strategies for using the interactive whiteboard to foster learner participation in school science. *Learning, Media and Technology*, **32**(3), pp.283–301.
- Hogarth, S., Bennett, J., Lubben, F., Campbell, B. and Robinson, A (2006). ICT in science teaching. Technical report. In *Research Evidence in Education Library*. London: EPPI-Centre, Social Science Research Unit, Institute of Education, University of London.
- McDermott, L.C., (1993). How we teach and how students learn - A mismatch? *Am. J. Phys.*, **61**(4), pp.295–298.
- Michelini, M. (2007). Attività seminariali Educazione scientifica ed approcci di ricerca in didattica della fisica.
- Miles, M.B., Huberman, A.M. and Saldaña, J. (2014). *Qualitative data analysis : a methods sourcebook*, Thousand Oaks [etc.]: Sage Publications.
- Murcia, K. (2008). Teaching for scientific literacy with an interactive whiteboard. *Teaching Science*, **54**(4), pp.17–21.
- Reay, N. W., Bao, L., Li, P., Warnakulasooriya, R. and Baugh, G. (2005). Toward the effective use of voting machines in physics lectures. *American Journal of Physics*, **73**(6), p.554.
- Sokoloff, D.R., Laws, P.W. and Thornton, R.K. (2007). RealTime Physics : active learning labs transforming the introductory laboratory. *European Journal of Physics*, **28**(3), pp.S83–S94.
- Trumper, R. and Gelbman, M. (2002). What Are MBLs for? An Example from Introductory Kinematics. *Journal of Computers in Mathematics and Science Teaching*, **21**, pp.207–227.

Affiliation and address information

Assunta Bonanno - Giacomo Bozzo – Peppino Sapia
PER (University of Calabria Physics Education Research Group)
Department of Biology, Ecology and Earth Sciences (DiBEST)
University of Calabria (UNICAL)
Via P. Bucci, Building 33C (seventh floor)
87036 Cosenza, CS
Italy
e-mail: assunta.bonanno@fis.unical.it; giacomo.bozzo@fis.unical.it; peppino.sapia@fis.unical.it.

Federica Napoli
Physics Graduate Student
Department of Physics,
University of Calabria (UNICAL)
Via P. Bucci, Building 33C (seventh floor)
87036 Cosenza, CS
Italy
federicanapoli91@gmail.com.

The Uses of Interactive Whiteboard in a Science Laboratory.

Giacomo Bozzo¹, Carme Grimalt-Alvaro², Víctor López Simó²

¹ *Physics Education Research (PER) Group – UNICAL, Italy;*

² *Centre for Research of Science and Mathematics Education (CRECIM), UAB, Spain.*

Abstract

In the last ten years several studies were conducted about the educational use of interactive whiteboard (IWB) in teaching and learning activities, showing different advantages introduced by this technology and analysing different implications for teachers (both from technical and pedagogical point of view). In this context, we planned a research with the aim of analysing the activities that can be performed through the interactive whiteboard in science laboratories, in order to characterize them in terms of both technical features and pedagogical goals. Furthermore, we investigated also the pedagogical approaches used by teachers to plan or to carry out these activities. For these purposes, we video-taped 20 sessions of didactic science laboratories where different science teachers used IWB with their students in an ICT-equipped laboratory, and we classified the video-clips by using three different dimensions of analysis: *Pedagogical Approaches*, *Technical Uses* and *Pedagogical Aims*. These dimensions of analysis allowed us to characterize the practices carried out through the interactive whiteboard in scientific contexts and to study how IWB blends in an inquiry-based science laboratory. Moreover, this analysis led us to identify different *specific IWB practices* that can produce results unattainable by using only traditional educational tools (such as whiteboard, computer and projector).

Keywords

Interactive Whiteboard (IWB), Physics Education, ICTs Technologies, Science Laboratories.

1. Introduction and objectives

In the last ten years several studies were conducted about the educational employment of interactive whiteboard (IWB) in teaching and learning activities. The first researches revealed important advantages in terms of pupils' motivation, attention and behaviour, showing that the activities performed using IWB are more attractive for teachers and students than the practices carried out through other classroom educational tools (Higgins et al. 2007; Smith et al. 2005). Moreover, different studies in education showed that IWB is suited to stimulate the interactions between students as well as between students and teacher (Higgins et al. 2007; Murcia 2008; Schmid 2007) and for this reason it can change both the practical and theoretical aspects of teaching and learning processes.

The multimodal functionality and the interactive nature of IWB give teachers the possibility to treat scientific contents with great flexibility, to choose different pedagogical approaches and to manage multimedia or multimodal representations with more efficiency than traditional educational tools (Hennessy et al. 2007; Jang & Tsai 2012; Kennewell & Beauchamp 2007). In this perspective, IWB provides students the opportunity to learn with different styles (Murcia 2008; Schmid 2007), combining traditional whiteboard actions (like writing, drawing, etc.) with new features (Jang & Tsai 2012), like the functions of capturing, emphasising, storing, and reviewing (Beauchamp & Parkinson 2005). From the science education viewpoint, these Information and Communication Technologies (ICTs) allow teachers and students to model abstract ideas in new ways (Higgins et al. 2007), to address complex and abstract concepts through dynamic representations and to switch easily between the different representations (Miller et al. 2004; Kennewell & Beauchamp 2007).

In the last years, many governments in the world invested great economic resources to provide schools with IWB. Unfortunately, despite all these economic efforts, a great number of teachers does not use IWB in everyday life classrooms or does not exploit its whole potential (Hermans et al. 2008; Glover & Miller 2001): this problem stimulated different researches in order to shed light on the causes of this underuse or inappropriate use of IWB in schools. In this sense, beyond the analysis of the factors that can affect the underuse of the interactive whiteboard, these studies broadened the multiple perspectives through which the

activities performed through IWB could be described. However, three perspectives of investigation were particularly relevant in our context of research.

(i) The first regards the *pedagogical approaches* used by teachers to plan or to carry out the practices that can be performed using an interactive whiteboard. In fact, a large number of teachers (even recognising some possible benefits of using IWB in their lessons) designs general activities with IWB aimed only to motivational and engaging goals without analysing how this technology can improve teaching and learning processes (Hammond et al. 2011). These activities also reinforce a *teacher-centred* approach in which teachers are the main actors (Higgins et al. 2007). On the contrary, some researchers stressed the importance of a *student-centred* approach, using IWB: taking into account the intrinsic hands-on nature of interactive whiteboard, some studies showed that “When the teacher is the only operator of IWB, it may offer little more than traditional computer demonstration” (Murcia 2008; Hennessy et al. 2007).

(ii) The second perspective is related to the underuse of IWB in teaching activities. In order to face this problem, some studies focused their attention on teachers’ abilities and familiarity with ICTs and showed that teachers’ technical skills with IWB influence their attitude to employ it in classroom (Becta 2004; Beauchamp 2004; Glover & Miller 2001). In order to improve teachers’ abilities or familiarity with IWB, some researchers listed different *teaching actions* that can be performed by using this technological tool (we call these *teaching actions* as IWB activities, IWB practices or IWB uses). These researches led us to deal with the second perspective of investigation regarding the analysis of IWB activities carried out in science laboratories from a technical point of view (i.e. *technical uses* perspective).

(iii) Finally, International literature showed that teachers’ difficulties in the use of IWB are related not only to their practical skills with IWB, but also to their beliefs about the potential value of ICTs from a pedagogical point of view (Mama & Hennessy 2013; Hermans et al. 2008). Different studies, analysing the pedagogical implications introduced by the employment of IWB in teaching activities, revealed the existence of relations between teachers’ beliefs and the use of interactive whiteboard (Mama & Hennessy 2013). Since teachers’ beliefs influence also the specific goals (from a pedagogical point of view) that can be reached through IWB activities, we focused our attention on the third perspective of investigation in order to analyse the *pedagogical aims* for IWB practices that can be performed in science laboratories.

The perspectives of investigation above described led us to face the important challenge regarding the classification and the characterization of IWB practices (both from technical and pedagogical point of view) in order to identify the *practices that can be performed only through an interactive whiteboard* (we will call them *specific IWB practices*) and that can produce results unattainable through traditional educational tools (such as whiteboard, computer and projector). In this sense, a specific IWB practice can be defined taking into account the framework proposed by Mama and Hennessy to analyse different teachers’ profiles (Mama & Hennessy 2013). We used their classification (regarding teachers’ profiles) to define two different ways of use the interactive whiteboard: *the integrational* way of use, that allows “to employ technology’s diversifying potential to address students’ needs”, and *the incremental* way of use, through which teachers “enhance their traditional, existing practices” (Mama & Hennessy 2013). In this perspective, we will consider **specific IWB practices** in inquiry-based science laboratories (Hofstein & Mamlok-Naaman 2007) those activities that allow exploiting the whole potential of IWB technology (i.e. the practices that give an extra value if compared with the activities that can be performed through traditional educational tools).

We planned this study in order to answer the following research questions:

RQ1 How can IWB be used in an inquiry-based science laboratory, considering the pedagogical approaches, the technical uses and the pedagogical aims and how much time is employed for these uses?

RQ2. Which of these identified uses can be considered activities that may be performed only through an IWB, in an inquiry-based science laboratory?

2. Design and procedure

In order to analyse how IWB can be used in a science laboratory, we recorded 20 experimental sessions (3/4 hours for each one) carried out in a ICT equipped educational science laboratory¹ in Autonomous University of Barcelona. These sessions were performed by groups of 20-30 secondary school students (of all levels), involving four different science teachers. All the activities were inquiry-based laboratory experiences (Hofstein & Mamlok-Naaman 2007), where students carried out real experiments with data loggers, interacted with simulations, discussed concept and experimental results between peers, etc.

¹ www.crecim.uab.cat/revir

We divided each session in different video-clips, so that each clip corresponds to a single IWB activity. We obtained 334 video-clips, which represent about 20% of the total time necessary to perform the 20 sessions (i.e. 14,5 hours of IWB video-clips compared with about 70 hours for the 20 sections). Taking into account that students were involved in experimental group-based activities, where (usually) most of time is dedicated to perform qualitative and quantitative hands-on experiments or to analyse experimental results, the time employed to use the interactive whiteboard represents an important part of the whole sessions.

Finally we classified each video-clip using an iterative process, through which we defined a set of categories, according to the qualitative analysis processes (Miles et al. 2014).

3. Results and Discussion

Taking into account the three perspectives of investigation previously described, we defined three dimensions of analysis (see Table 1).

The first dimension (“*Pedagogical Approaches*” - see **D1** dimension in Table 1) allowed us to investigate in which way teacher involves students in each activity. IWB actions from this perspective were characterised as teacher-centred or student-centred approach: the first refers to the practices when teacher is the main actor (while using IWB) and students are only the audience (*T* category of D1 dimension); the second one refers to the activities where students play a crucial and active role (*S* category of D1 dimension), even if teacher handles IWB, because in these cases his/her actions are guided by students discussions, answers to specific questions, experimental results, etc.

Table 1. The Dimensions of Analysis (D1) Pedagogical Approach, (D2) Technical Uses and (D3) Pedagogical Aims represent the first important result of the study proposed in this paper.

	Code	Name - Definition
D1	S	Student-Centred: IWB activity stimulates students’ interactions between them or with the teacher.
	T	Teacher-Centred: Teacher is the main actor of IWB activity.
D2	WHI	Whiteboard: IWB is used to write, to draw, to use colours, etc...
	PRO	Computer & Projector: IWB is used to show pictures, graphs, experimental results, WEB pages - without interaction with displayed contents.
	WHI+PRO	Whiteboard + Computer & Projector: IWB is used to superpose new tracks on the displayed contents, (draw on a photo, fill a table, etc...) - without any change of the back contents.
	IWB_d&d	Drag and drop group: IWB is used (1) to move/classify/order, (2) to group, (2) to modify the sides of the objects and (4) to capture the images on IWB (screenshot).
	IWB_nav	Navigation: IWB is used to scroll or to change WEB pages or displayed documents.
	IWB_b&f	Back and Forward: IWB is used to refer/display/use previous stored information.
D3	EXP	Explore previous ideas: Teacher makes a specific question in order to explore students’ previous idea about the proposed activity.
	INT&DIS_conc	Introduce and discuss concept: Teacher introduces & discusses concepts, through questions, explanations, discussions, etc.
	INT_proc	Introduce procedure: Teacher introduces the experimental activity “step by step”.
	ANL_data	Analyse data: Students/teachers introduce experimental results to IWB (numbers, tables, graphs, etc...), and organize the displayed data through discussions.
	SUM	Summarize: Students/teachers summarize, structure, organize or revisit the outcomes (results, concepts, ideas) of previous activities.
	APP	Apply: Students apply the outcomes in a different context.

Moreover, the second dimension of analysis (“*Technical Uses*” - see **D2** dimension in Table 1) was aimed to characterise IWB activities whether they could be carried out with traditional displaying tools (like whiteboard, PC and projector) or whether they could only be performed by this tool. In this sense, the first three categories of D2 dimension correspond to IWB uses as a traditional tool, **(a)** displaying pictures, texts, experimental results, like a traditional pc and projector (*PRO* category), **(b)** writing or drawing, like a traditional whiteboard (*WHI* category - see Figure 2C for an example), **(c)** displaying tables, graphs, or any kind of picture and writing on the displayed picture (for example, Figure 2A shows a student that fills some displayed template in order to introduce experimental results; we classified this action like *WHI+PRO* since teacher could propose it to the classroom projecting on the whiteboard the template and students could fill the template without any interaction with the displayed image). The remaining D2 categories (*IWB_d&d*, *IWB_nav* and *IWB_b&f*) represent the uses of IWB that cannot be performed through traditional educational tools (see the Table 1 for more details). In details, *IWB_d&d* practice allows to move objects, sentences, pictures, etc., in order to classify or to order them: consequently, the position of the objects on the whiteboard takes on a conceptual meaning (Figure 2D shows a *IWB_d&d* activity in which teacher classified different sentences, written by students, through drag and drop movements). We grouped in drag and drop category some different IWB practices related with drag and drop movement, like *size modification* of the object displayed on IWB, *grouping* different objects (in order to drag them simultaneously) and *capture* the images displayed on IWB. The last two categories indicates, respectively, the activities through which navigate web pages or documents displayed on the screen (i.e. *IWB_nav*) and retrieve previous stored information (i.e. *IWB_b&f*).

The full set of D2 categories summarize the activities that can be carried out in science laboratories by using an Interactive Whiteboard, according with (and implementing) more general lists available in literature (Miller et al. 2004; Higgins et al. 2007; Beauchamp & Parkinson 2005). However, our classification introduces new elements to the discussion, since it allows establishing which are the effective added values introduced by IWB technologies.

Finally, considering also the aims of the interactions, we introduced a third dimension of analysis (“*Pedagogical Aims*” - see **D3** dimension in Table 1) through which we detected the pedagogical goals for each IWB activity (see **D3** - Table 1), according with (and extending) the classifications available in literature (see for example Beauchamp & Parkinson 2005). In details, taking into account international literature about the *dynamics of learning processes* (see for example Lawson & Karplus 2002) we defined six categories of pedagogical aims in order to identify which typical step of learning cycles corresponds to each specific activity of science laboratories. In this way, we were able to characterize IWB practices in terms of **(a)** exploring students’ previous idea (*EXP* category), **(b)** introducing and discussing different concepts through questions, explanations and discussions (*INT&DIS_conc* category), **(c)** introducing an experimental procedure (*INT_proc* category), **(d)** analysing experimental results (*ANL_data* category), **(e)** summarizing or structuring the outcomes of previous activities (*SUM* category) and **(f)** applying the outcomes in different contexts (*APP* category).

The categories obtained for each dimension of analysis (summarised in Table 1) allowed us to characterize IWB practices recorded during the 20 sessions. In fact, each activity was classified in terms of a specific pedagogical approach, of a defined technical use and of an explicit pedagogical aim. In this way, our classification offers the possibility to define a *3D category system*, in which each dimension of analysis represents a specific *feature* for IWB recorded practices. Taking into account the possible combinations between the defined categories (two categories for D1, six for D2 and D3), our classification (theoretically) allows distinguishing 72 different kinds of IWB practices. However, during the 20 recorded sessions, we observed 54 different IWB practices. The Figure 1 represents the 54 observed activities versus the total time employed to carry out each specific kind of practice: each bar corresponds to a specific activity defined by the 3D category system, while the height of the columns corresponds to the total time employed for each kind of activity.

The analysis of D1 categories shows that approximately 2/3 of IWB activities were focused on students (9 hours of student-centred activities that correspond to the 61% of the total 14,5 hours employed to carry out all IWB practices). In fact, even if teachers are the handler of the interactive whiteboard, most of recorded cases show that learners are the principal actors (for example, most of practices are centred on students’ previous ideas, on their experimental results, on their conclusions, etc...).

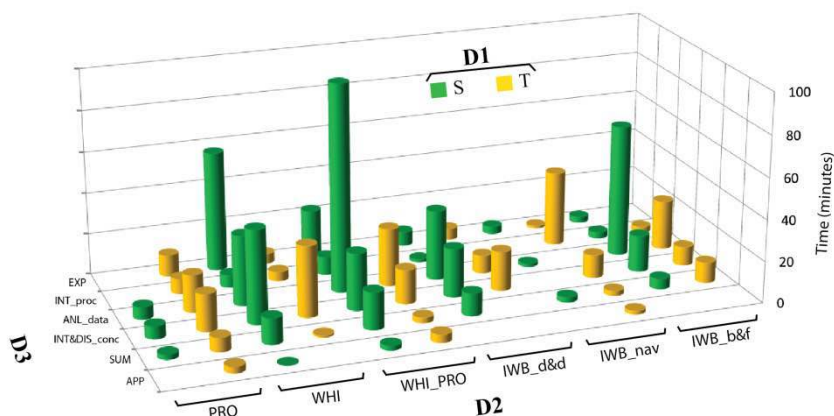

Figure 1. D1 (Pedagogical Approaches *S* and *T*), D2 (Technical Uses) and D3 (Pedagogical Aims) categories compared with the time employed for each activity.

As regard the analysis of D2 categories, the Figure 1 shows that the interactive whiteboard is used for about 61% of time² performing activities that could be carried out through traditional educational tools (like whiteboard and/or projector).

The analysis of IWB practices led us to identify some uses that can be considered as specific IWB practices, because they add extra value to science laboratory activities even if they are short in time. For example, all IWB activity grouped in drag and drop categories or the back and forward analysis can be performed only using an interactive whiteboard, and even if they are not very significant from a quantitative point of view (because they need a short time to be performed; see Figure 1 – D2), they are typically student-centred activities (see Figure 1 – D1) that can give relevant contributions from a pedagogical perspective (see Figure 1 – D3). In details, drag and drop (*IWB_d&d*) practices are engaging activities for students, which offer the possibility (a) to classify and analyse experimental results, (b) to classify objects, concepts, data, etc. (c) to discuss concepts, and etc. The Figure 2B shows an example of *IWB_d&d* in which teacher performs a drag and drop action, classifying students experimental results previously written through the *WHI+PRO* practice. This is a typically student-centred example, in which teacher stimulates students' discussions, classifies the experimental results taking into account learners' ideas, and (consequently) helps students to improve their visual representation regarding different concepts or phenomena (that is an important and difficult educational goal in science laboratories, as shown by international literature in the last thirty years).

Another example of student-centred activity that can be performed only using an IWB and that allows exploiting the whole potential of this educational tool is represented by the opportunity to move and analyse back and forward the slide used during the activities (*IWB_b&f*): the Figure 2D shows an example of activity in which teacher uses the texts and draws previously written by students on IWB in order to compare the experimental results with students' previous ideas. This technical function is one of the most mentioned by international literature in education (Higgins et al. 2007) and plays a crucial role in a science laboratory, because it allows teacher and students to discuss the activities previously carried out (i.e. experimental results, analysis of students' spontaneous ideas, experimental predictions in the light of new evidences founded). In this perspective, if we consider the results of our study arising both from the technical uses and from the pedagogical aims analysis, we can state that *IWB_b&f* is the technical use that can enhance the development of learning cycles of science laboratorial activities, that is Predict, Observe and Explain (POE) cycle.

² 9 hours of practices in which IWB is used like a traditional whiteboard and/or a projector, among the total 14,5 hours necessary to perform the whole IWB activities.

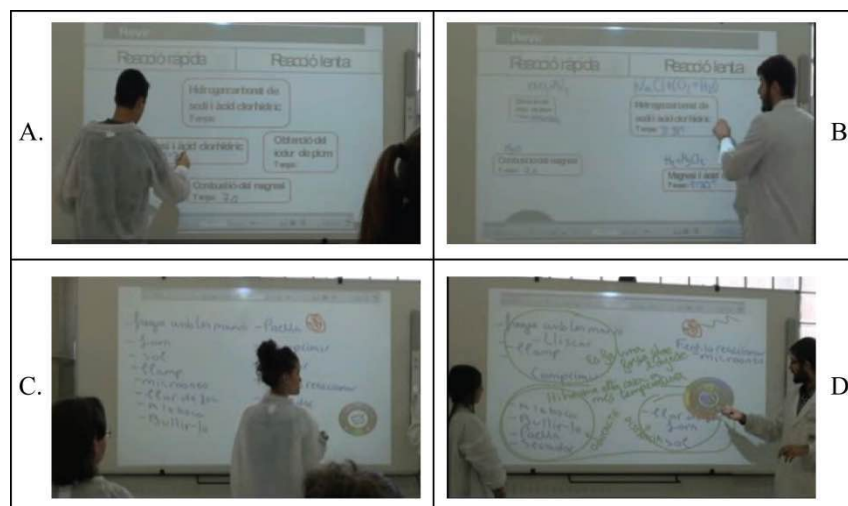

Figure 2. (A) WHI+PRO, in which students fill a template displayed on IWB; (B) IWB_d&d, through which teacher classify students' results through drag and drop movements, taking into account pupils idea about the classification; (C) WHI, in which students write on IWB their previous idea; (D) IWB_b&f, through which teacher uses stored information at the end of experimental activities to discuss different concepts with students.

Finally, further statements regarding the additional benefits that IWB introduces in a science laboratory arise from the analysis of the relationships between the D2 and D3 dimensions. In fact, the Figure 1 shows that some pedagogical aims are mainly developed with particular technical uses. For instance, “explore students' ideas” was mainly reached through *WHI* technical use, because it corresponds to activities in which teacher writes students' ideas, or students come up to the whiteboard to write their experimental results, or their previous idea by answering specific questions, etc. (See for example Figure 2C: student writes on IWB her ideas, answering to teacher's questions).

Another interesting relationship appears when teachers introduce and discuss students' experimental results (pedagogical aims: *ANL_data*). The Figure 1 shows that this pedagogical aim was reached mainly employing two technical uses: *IWB_b&f* and *WHI+PRO*. Regarding the relationship between *IWB_b&f* technical use and the *ANL_data* pedagogical aim, we showed above that IWB gives a crucial contribution if teacher retrieves the previous information performed by students during the lab activities (Figure 2D). The relationship between the *WHI+PRO* technical use and the *ANL_data* pedagogical aim shows that many discussions of experimental results could be performed using a whiteboard coupled with a projector (Figure 2A). However, the only difference between the two uses is that the interactive whiteboard allows teacher to store information displayed on the board. Moreover, the direct interaction with IWB allows the teacher to better manage the activity in terms of agility instead of using a whiteboard-pc-projector. As it has been highlighted by Beauchamp (Beauchamp, 2004), teachers spend a considerable part of time managing the PC and moving back and forth from the desk to the whiteboard.

Finally, an important relationship between D2 and D3 categories is represented by *IWB_nav* technical use and the *INT_proc* pedagogical goal, which consists on navigating through the content of documents, web pages, etc. in order to search information or to introduce a procedure. This is a typical teacher-centred activity that could be performed using a whiteboard coupled to a projector and that can take advantages of IWB employment (as described before) in terms of teachers' agility and of time employed. This statement allows us to observe that IWB can improve also typical teacher-centred activities performed in a science laboratory.

4. Remarks and Implications

This research allows us to classify IWB ways of use, taking into account the pedagogical approaches, the technical uses and the pedagogical aims (**RQ1**).

A first important outcome regards students' involvement during the activities performed using an interactive whiteboard in a science laboratory. In fact, our research leads us to extend the results of different generic studies about the educational role of IWB, since it allows teacher to propose and perform activities that involve students during science laboratory sessions (i.e. IWB could stimulate student-centred pedagogical approaches of teacher).

Moreover, our work proposes a classification of IWB practices carried out in a specific inquiry-based science laboratory. In particular, the analysis of the technical uses leads us to conclude that, although a part of IWB activities can be performed without an interactive screen, there are some unique IWB practices that give sufficient reason to use this tool in science laboratory activities from a pedagogical point of view. In this sense, our study shows that the time distribution of IWB technical uses (obtained in this paper) is influenced also by the intrinsic nature of particular activities related to specific pedagogical aims. Furthermore, this study evidences that the interactive whiteboard introduces benefits also when it is used like traditional educational tools, because it helps teacher to conducting the activity without losing the eye contact with the classroom.

As regard the activities that can be performed only using the interactive whiteboard, they represent the added value given by this technology and allow exploiting the whole IWB potential, even if they are short in time. Finally, our study shows that the relationships between the technical-uses and pedagogical-aims dimensions are unevenly distributed over the time employed to perform all IWB practices during the 20 sessions. This result allows us to conclude that the aforementioned relationships could suggest to teachers the optimal uses of IWB for a specific pedagogical aim.

As regard the second research question (**RQ2**), the analysis of technical uses and pedagogical aims provides us the possibility to identify some specific IWB practices that can be carried out employing the interactive whiteboard in a science laboratory. For example, the possibility to retrieve stored information adds significant value to the activity previously performed. In this sense, the back and forward action takes advantage from the long-time employed for some practices (that could be performed with traditional educational tools), since it allows to compare students previous ideas or prediction with the outcomes of experimental activities (i.e. the typical predict-observe-explain cycle used in science laboratories). Another example is represented by the drag and drop group of activities that helps teacher to deal with specific pedagogical aims (like the introduction and discussion of concepts or like the analysis of experimental results), since it allows to move and classify the objects displayed on the whiteboard, giving in this way a meaning to the classification from a conceptual point of view. If we take into account also IWB function to store information, we can conclude that drag and drop represent a second kind of specific IWB practice that gives meaning to the long-time employed for the activities that could be performed through traditional educational tools, since it allows to discuss previous results in a new way. Finally, another specific IWB practice is represented by IWB navigation action, since it allows teacher to better manage the activity of experimental procedures' introduction in terms of agility instead of using a whiteboard-pc-projector, improving in this way also a typical teacher-centred activity.

Acknowledgment

Part of this research was funded by ARUE Project of Calabria Region (Research Grant of European Union).



Bibliography

- Beauchamp, G. (2004). Teacher Use of the Interactive Whiteboard in Primary Schools : towards an effective transition framework. *Technology, pedagogy and education*, **13** (3), pp.327–348.
- Beauchamp, G. and Parkinson, J. (2005). Beyond the “wow”factor: developing interactivity with the interactive whiteboard. *School Science Review*, **86** (316), pp.97–104.
- Becta (2004). *A review of the research literature on barriers to the uptake of ICT by teachers*, British Educational Communications and Technology Agency (Becta), 2004, Version 1.
- Glover, D. & Miller, D. (2001). Running with technology: the pedagogic impact of the large-scale introduction of interactive whiteboards in one secondary school. *Journal of Information Technology for Teacher Education*, **10** (3), pp.257–278.
- Hammond, M., Reynolds, L. and Ingram, J. (2011). How and why do student teachers use ICT? *Journal of Computer Assisted Learning*, **27** (1), pp.191–203.

- Hennessey, S., Deaney, R., Ruthven, K. and Winterbottom, M. (2007). Pedagogical strategies for using the interactive whiteboard to foster learner participation in school science. *Learning, Media and Technology*, **32** (3), pp.283–301.
- Hermans, R., Tondeur, J., van Braak, J. and Valcke, M. (2008). The impact of primary school teachers' educational beliefs on the classroom use of computers. *Computers & Education*, **51** (4), pp.1499–1509.
- Higgins, S., Beauchamp, G. and Miller, D. (2007). Reviewing the literature on interactive whiteboards. *Learning, Media and Technology*, **32** (3), pp.213–225.
- Hofstein, A. and Mamlok-Naaman, R. (2007). The laboratory in science education: the state of the art. *Chemistry Education Research and Practice*, **8** (2), pp.105–107.
- Jang, S. J. and Tsai, M. F. (2012). Exploring the TPACK of Taiwanese elementary mathematics and science teachers with respect to use of interactive whiteboards. *Computers & Education*, **59** (2), pp.327–338.
- Kennewell, S. and Beauchamp, G. (2007). The features of interactive whiteboards and their influence on learning. *Learning, Media and Technology*, **32** (3), pp.227–241.
- Lawson, A.E. & Karplus, R. (2002). The Learning Cycle. In R. G. Fuller, ed. *A Love of Discovery. Innovations in Science Education and Technology*. Dordrecht: Springer Netherlands, pp. 51–76.
- Mama, M. and Hennessey, S. (2013). Developing a typology of teacher beliefs and practices concerning classroom use of ICT. *Computers and Education*, **68**, pp.380–387.
- Miles, M.B., Huberman, A.M. & Saldaña, J. (2014). *Qualitative data analysis: a methods sourcebook*, Thousand Oaks [etc.]: Sage Publications.
- Miller, D., Glover, D. and Averis, D. (2004). Matching technology and pedagogy in teaching mathematics: Understanding fractions using a “virtual manipulative” fraction wall. *Annual Conference of the British Educational Research Association Conference*, UMIST, Manchester.
- Murcia, K. (2008). Teaching for scientific literacy with an interactive whiteboard. *Teaching Science*, **54** (4), pp.17–21.
- Schmid, E. C. (2007). Enhancing performance knowledge and self-esteem in classroom language learning: The potential of the ACTIVote component of interactive whiteboard technology. *System*, **35** (2), pp.119–133.
- Smith, H. J., Higgins, S., Wall, K. and Miller, J. (2005). Interactive whiteboards: boon or bandwagon? A critical review of the literature. *Journal of Computer Assisted Learning*, **21**, pp.91–101.

Affiliation and address information

Giacomo Bozzo
PER (University of Calabria Physics Education Research Group)
Department of Biology, Ecology and Earth Sciences (DiBEST)
University of Calabria (UNICAL)
Via P. Bucci, Building 33C (seventh floor)
87036 Cosenza, CS, Italy
e-mail: giacomo.bozzo@fis.unical.it

Carne Grimalt-Alvaro & Víctor López Simó
CRECIM (UAB - Centre for Research of Science and Mathematics Education)
Autonomous University of Barcelona (UAB)
Campus UAB, Building GL, 304
08193 Bellaterra, Barcelona, Spain
e-mail: carne.grimalt@uab.cat & victor.lopez@uab.cat.

Preparing Pre-service Teachers to Integrate Technology into Inquiry-Based Science Education: Three Case Studies in the Netherlands

Trinh-Ba Tran¹, Ed van den Berg¹, Ton Ellermeijer², Jos Beishuizen¹

¹ VU University Amsterdam, the Netherlands

² Foundation CMA, the Netherlands

Abstract

Integration of technology (e.g. measuring with sensors, video measurement, and modeling) into secondary-school science teaching is a need globally recognized. A central issue of incorporating these technologies in teaching is how to turn manipulations of equipment and software into manipulations of ideas. Therefore, preparation for pre-service teachers to apply ICT tools should be combined with the issues of minds-on inquiring and meaning-making. From this perspective, we developed a course within the post-graduate teacher-education program in the Netherlands. During the course, pre-service teachers learnt not only to master ICT skills but also to design, teach, and evaluate an inquiry-based lesson in which the ICT tool was integrated. Besides three life sessions, teachers' learning scenario also consisted of individual tasks which teachers could carry out mostly in the school or at home with support materials and online assistance. We taught three iterations of the course within a design-research framework in 2013, 2014 and collected data on the teacher learning processes and outcomes. The analyses of these data from observation, interviews, questionnaires, and documents were to evaluate implementation of the course, then suggest for revisions of the course set-up, which was executed and then assessed again in a subsequent case study. Main outcomes of the three case studies can be summarized as follows: within a limited time (3 life sessions spread over 2 – 3 months), the heterogeneous groups of pre-service teachers achieved a reasonable level of competence regarding the use of ICT tools in inquiry-based lessons. The blended set-up with support materials, especially the Coach activities and the lesson-plan form for an ICT-integrated inquiry-based lesson, contributed to this result under the condition that the course participants really spent considerable time outside the life sessions. There was a need for more time for hands-on, in-group activities in life sessions and more detailed feedback on individual reports of pre-service teachers. The majority of the pre-service teachers were able to design a lesson plan aimed at a certain inquiry level with integration of ICT, but just a few could implement it faithfully in the classroom. There was still a considerable difference between intended inquiry activities and actual realized inquiry which parallels results from the literature for experienced teachers. The participants had to struggle with science - ICT conceptual issues as well as getting their students to focus on inquiry and concept learning in the classroom. Each evaluation guided iteration of the course resulted in better learning outcomes.

Keywords

Coach, ESTABLISH, IBSE, ICT, Pre-service Teacher Education, Post-graduate, the Netherlands

1 Introduction

1.1 Background and context

Since the beginning of 1980s, the international community has widely recognized possibilities of Information and Communications Technology (ICT) to stimulate inquiry-based teaching and learning of science. Firstly, tools for gathering data with sensors became available, and also environments for dynamical modeling. Later on, the multimedia power of computers enabled video measurement and simulations. These technology applications enable teachers to motivate and support secondary-school students to construct understandings of scientific concepts. Although these tools have been available for thirty years in teacher education and training, it is still questionable how far teachers are with respect to good practices of these ICT tools in the 'normal' teaching of science. Actually proper use of these potentials of technology in science education is rather far away.

Abrahams and Millar (2008) observed 25 "typical" laboratory lessons in English secondary schools and concluded that "*Practical work was generally effective in getting students to do what is intended with physical objects, but much less effective in getting them to use the intended scientific ideas to guide their actions and reflect upon the data they collect*" (p. 1945). Teachers sometimes tried to apply innovative ICT tools in the classroom, but mostly in traditional ways in which they provided a cook-book list of tasks for students to follow ritualistically. Meanwhile, students knew in advance from the text-book what would come out from the laboratory. This was concluded by Hofstein and Lunetta (2004, p.47) in a review of decades of research on laboratory use in science education. On the one hand, high-tech tools such as data logging, video measurement, and modeling are powerful in many cases in which traditional laboratory instruments or secondary-mathematics prior-knowledge cannot help students to investigate real-life phenomena. On the other hand, students always need a lot of instruction and time to handle these ICT tools. Direct instruction like "do this, then do that" might be the fastest and most convenient method, but it does not promote student's minds-on inquiring and meaning making. The challenge to teachers in applying ICT as laboratory instruments, therefore, is how to turn manipulations of equipment (e.g. experiment apparatus, sensors, and software) into manipulations of ideas (e.g. ideas, theories, and hypotheses) (Berg, 2013, p.75).

Shulman (1986) developed the idea of Pedagogical Content Knowledge (PCK) to describe knowledge on how to teach a specific content (e.g. a science concept), which has become a widely-accepted conceptual basis for subject-focused pedagogy. Koehler and Mishra (2005) built on Shulman's formulation of PCK and added technology (e.g. laboratory instruments, educational software) as a key component to the framework. They proposed the concept of Technological Pedagogical Content Knowledge (TPCK), which is knowledge about using technology to teach specific contents.

1.2 Development of a teacher-education course on integration of technology into science education

Our project aims at developing a course for pre-service teachers in which preparation for teachers to integrate technology in science education should be combined with the issues of inquiry-based teaching. Based on the TPCK framework, the content goals of our course could be stated as:

- TCK (Technological Content Knowledge): Teachers' learning to use ICT tools in the science laboratory
- TPCK: Teachers' learning to apply these tools to teach an inquiry-based lesson in the classroom

The TCK concerned three ICT tools: data logging, video measurement, and modeling which are integrated in an authoring and learning environment, called Coach. Coach is present in almost all Dutch secondary-schools. In Europe, Coach is used in many countries, available in many languages (<http://www.cma-science.nl/>). It offers tools with flexible authoring facilities which enable inquiry-based approaches with more realistic contexts for science lessons (Heck et al., 2009, p.153).

The central design issue is how to develop a time-effective course in which pre-service teachers with heterogeneous backgrounds (see Section 2.2) within a limited time learn to apply the ICT tool in such a way there must be inquiry components in laboratory activities. The theoretical exploration in this research and development domain (Tran et al, 2014) suggested us three main requirements which the participating teachers should fulfill during the course:

- 1) Becoming aware of possibilities of ICT tools and learning in depth only one tool by choice,
- 2) Carrying out a complete cycle of designing, implementing, and evaluating an ICT-integrated inquiry-based lesson in the classroom,
- 3) Learning on their own most of the time through life sessions and individual tasks with support materials and online assistance.

These requirements are the three principles underlying our course design. To optimize the course, we taught, evaluated, and revised it through the iteration of the three case studies in the Netherlands.

1.3 Research questions and design-based research approach

Development, evaluation, and optimization of the course have been driven by the following research questions:

- 1) To what extent was the course implemented as intended? To what extent did the course have effects as expected?
- 2) What were technological and pedagogical problems of teachers in learning to use and apply the ICT tools in an inquiry-based lesson?

- 3) What suggestions for revision of the course came out of course evaluation (driven by questions 1 and 2), aiming at teachers' more-effective learning? And did the revision work out in the subsequent iteration of the course?

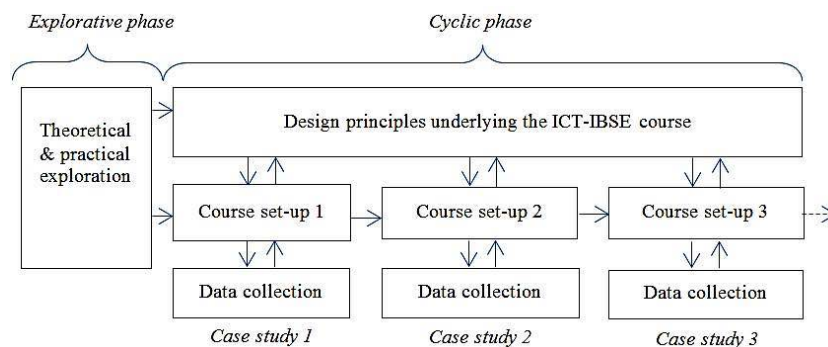

Figure 1. Research design – optimization of the course through three case studies (adjusted from Knippels, 2002, p.15)

We utilized a design-based research framework which consists of two successive stages: the explorative phase and the cyclic phase (Figure 1). This paper presents research findings from the cyclic phase with three case studies in the Netherlands; in each of which we executed the course and simultaneously collected data on teachers' learning process (formative assessment) and teachers' learning outcomes (summative assessment). Analysis of the collected data helped us to evaluate faithful implementation and effectiveness of the course (Question 1) as well as to identify problems of the pre-service teachers in learning to use and apply the ICT tools in an inquiry-based lesson (Question 2). Based on the course evaluation after each case study, we revised, and then executed and evaluated the course again in the subsequent iteration. Assessment on whether revisions worked out in the next round was also taken into account (Question 3).

2 Method

2.1 Participants and boundary conditions of the course

The course was offered jointly by Dutch universities (i.e. VU, UU, UvA, and TU Delft) within the second semester of the one-year, post-graduate, teacher-education program. A total of 33 pre-service teachers (more physics teachers than chemistry) took part in one of the three iterations of the course (Table 1). The teachers were willing to cooperate with us to gather data from their learning as well as teaching in the classroom.

Table 1. Three case studies (CS) in the context of a teacher-education one-EC course in the Netherlands

Case study	Duration	Time for 3 life sessions	Time anticipated for individual tasks	Teachers in total	First-year teaching	Partly paid/internship
CS1	5 weeks, 28/1 – 4/3/2013	3 hours each	19 hours	12	9	5
CS2	7 weeks, 6/5 – 24/6/2013	3 hours each	19 hours	12	10	5
CS3	11 weeks, 17/2 – 16/5/2014	Session 1: 6 hours Sessions 2, 3: 3 hours each	16 hours	9	8	2

For more information about the context of science-teacher education in the Netherlands and about the boundary conditions in the course, we refer to Tran et al. (2014). Here we summarize briefly:

- Time intended for the course was very limited (only one EC equivalent to 28 learning hours) in regard to extensive activities (e.g. demonstrations, hands-on, discussions, reports, etc.) in life sessions and intensive individual tasks of practicing the new ICT tool and trying out the lesson plan in the classroom.

Meanwhile, most of the participating teachers were experiencing pressures of a first year teacher, and many of them already had a teacher appointment rather than only a guided internship (Table 1). Therefore, they had to struggle with management of time and energy for university-course assignments, preparation for regular lessons, and extra school-tasks. In short, the time for teachers to carry out individual tasks was really limited.

- All of the teachers had at least a Bachelor of Science and one-year master studies in their subjects. However, their backgrounds were very heterogeneous in terms of age (from 24 to 50 years old); mastery of subject area knowledge (from just graduated to a PhD or even years of research experience in physics or chemistry); experience with the ICT tools (many participants knew very little about video measurement or modeling; some were quite familiar with data logging; some had no experience with Coach, but with another platform). Their teaching conditions (e.g. levels of students, the school's experience with ICT applications in science, and infrastructure like software, sensors, interfaces, and computers) were very different as well.

2.2 Teachers' learning scenario, support materials, and assessment instruments

From the design principles, we elaborated the course set-up, which interacted with the boundary conditions, including three components: teachers' learning scenario, support materials, and assessment instruments. Initially the three life sessions in the course were spread over 5 weeks, later this was extended to 7 and finally 11 weeks in order to allow more time for the classroom try-out of teachers' lesson plans (Table 1). In between life sessions were two teachers' successive individual tasks (Figure 2) which were coupled with the two content goals (TCK & TPCK). In Session 1 teachers were taught about possibilities of the three tools, and then they were suggested to specialize in one tool by choice (Figure 3a). Task 1 required teachers to continue mastering the tool they chose by practicing the given Coach activities. In Session 2, the teachers designed an inquiry-based lesson plan with ICT activities which utilized the chosen Coach tool. Task 2 required teachers to try out their lesson plans in the classroom (Figures 3b, 3c). Lastly, in Session 3 the teachers reported and evaluated their try-outs (Figure 3d). In a nutshell, we motivated and supported the teachers to follow a flexible scenario in which they started from a broad perspective about possibilities of using three ICT tools in science education (Session 1), and then they went deeply and narrowly (Figure 2) to the core of learning to use one tool (Task 1) to teach one lesson to one class at a certain level of inquiry in a particular context (Session 2, Task 2), so that they could reflect (Session 3) and really appreciate the integration of ICT into Inquiry-Based Science Education (IBSE).

Tran et al. (2014) described the support materials which were used for Case study 1, and those did not change much for Case studies 2 and 3. For the TCK domain, the Coach activities were for teachers to master their chosen tool mostly on their own. For the TPCK domain, we designed a form for an ICT-IBSE lesson plan for teachers. It was like a scaffold with five phases (i.e. orientation, design of experiment, execution, interpretation, and what did we learn) for teachers to construct their own plan of applying the ICT tool in an inquiry-based lesson. There are additional questions/ requirements in the form such as "What will you do to make sure the lesson is minds-on?", "Prepare examples of teacher questions when going around to stimulate minds-on". A list of inquiry skills is given at the end of the form, and teachers had to indicate which skills they incorporated in their lesson. The teachers could browse these support materials on the course's online environment. We also provided teachers online assistance (via emails, forums) whenever they encountered any difficulties in carrying out the individual tasks.

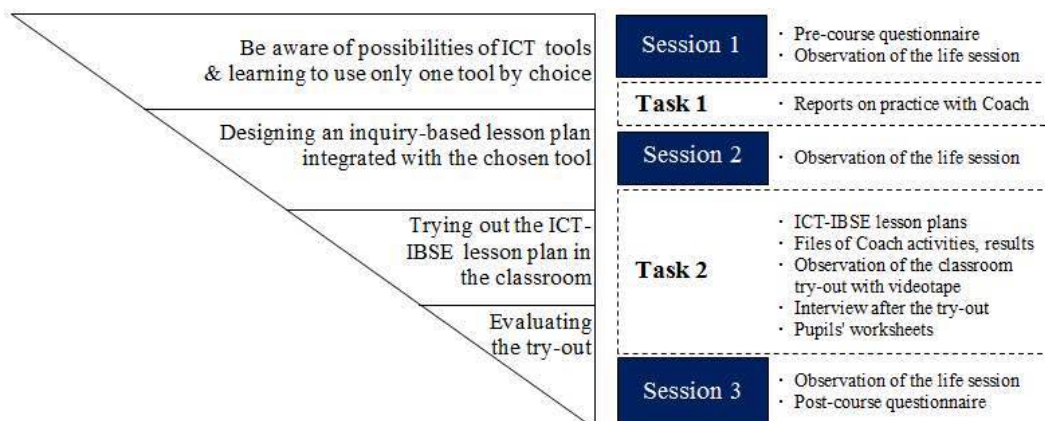

Figure 2. The course's scenario for teachers' learning and data collection

Regarding evaluations of teachers' professional development, Guskey (2002) introduced five critical levels: level 1 - teachers' reactions, level 2 - teachers' learning, level 3 - organization support & change, level 4 - teachers' use of new knowledge and skills, level 5 - students' learning outcomes. The assessment of teachers' learning during our course (Figure 2) only focused on levels 1, 2, and 4. We utilized multiple data-collection methods such as pre- and post-questionnaires, observation (Figure 3), interviews, and documents. Therefore, a finding from one source can be compared and contrasted with that from another to ensure internal validity of data analysis. For example, we asked teachers to submit their lesson plans in advance (documents), and then commented on it. Next, we came to their schools to observe their classroom try-outs with videos taped (Observation). After that, we carried out a semi-structured interview with voice recorded (Interview) to get their self-evaluations of the try-outs.



Figure 3. Teachers' activities in chronological order of the teachers' learning scenario

3. Results

Outcomes of the three case studies are presented in the following three sections which are coupled with the three research questions. To some particular aspects, we clarify results of each case study so that the reader might judge the development process of the course throughout the three iterations. The data collected from various resources were consistent with each other. Data about individual teachers vary, reflecting heterogeneity of their backgrounds and teaching conditions, but all of these data indicate improvement of their knowledge and skills to some extent in regard to the use of ICT for IBSE.

3.1 Faithful implementation and effectiveness of the course

3.1.1 Faithful implementation of the course – assessment of teachers' learning process

All activities (i.e. lectures, demonstrations, hands-on practice, and group-discussions) intended for life sessions were covered and executed quite smoothly. 29 pre-service teachers (out of 33) fulfilled the complete cycle of designing, implementing, and evaluating an ICT-IBSE lesson in the classroom (Table 2). Through teachers' self-reports, we estimated that they invested 14.5 hours on average outside the life sessions, and this number did not deviate much from what we had anticipated (Table 1). The largest proportion of this time was for preparing the lesson plan with the related Coach activity (5.3 hours, $SD = 3.0$), followed by 3.9 hours ($SD = 2.0$) for practicing the Coach activities, 3.0 hours ($SD = 1.6$) for arranging, executing, and evaluating the classroom try-out.

a) What did not go as intended

The most remarkable deviation was that 17 teachers (incl. 10 in CS1, 5 in CS2, 2 in CS3) (Table 2) could not try out their lesson plans before Session 3 which was intended for them to share their classroom experience. Accordingly, the intended activities for Session 3 had to be adjusted to suit teachers at different stages of the learning scenario. In addition, we had to spend weeks after the course to follow teachers' try-outs. Eventually, 13 teachers (out of 17) managed to implement their lesson plans, but they did not have an opportunity to get feedback on the try-out from fellow teachers and teacher-educators.

Table 2. Numbers of teachers, who tried out the lesson plan (before or after Session 3) or not at all

	N	Before Session 3	After Session 3	Not try out at all
CS1	12	2 (16.7 %)	9	1
CS2	12	7 (58.3 %)	2	3
CS3	9	7 (77.8 %)	2	0
Total	33	16	13	4

11 teachers (incl. 5 in CS1, 4 in CS2, 2 in CS3) did not follow the suggestion of specializing in only one tool, which was emphasized in both the course documents and Session 1. In Session 1, many teachers were eager to learn new tools (e.g. modeling or video measurement). Unexpectedly, conditions (e.g. students' familiarity with the tool, room in the curriculum) for application of modeling or video measurement were inconvenient to some teachers. Therefore, they had to apply another tool (e.g. data logging) in order to prepare a lesson plan which was feasible for the classroom try-out. However, most of these teachers could not reach advanced skills with Coach.

The teachers did not utilize the online environment as much as we expected. We designed the forum (within Moodle for CS1, CS2 or Google for CS3) for teachers to discuss with peers or teacher educators about their difficulties to individual tasks, but they did not post any questions on the forum at all. Additionally, most of teachers struggled a lot with technical details of the Moodle platform (CS1 and CS2) whereas they only used it as a resource of support materials. Consequently, for Case study 3 we just designed and offered a static, simple webpage with the course's description and support materials. In fact, some teachers asked via email about ICT problems. Other teachers asked their Coach-experienced colleagues in the school, and some others left the questions for life sessions. It turned out to be rather difficult and took time for teachers to explain an ICT problem, and then discuss back and forth in text via the Internet. Even with us as Coach-experienced users, we had to spend much time to understand teachers' questions, and then prepare descriptive texts with screen-shoots or video clips for effective online communication. On the other hand, discussions via the Internet about the inquiry-based lesson plan went quite well. Therefore, in later iterations of the course we increased practice time with the tools during life sessions, so any trouble shooting could be done quickly with assistance of peers and the teacher educators rather than with much frustration at home.

b) Obstacles to teachers' ICT-IBSE tryouts

Pre-service teachers' workload was high and demanding. Here was one of many teachers' complaints, "*I'm afraid I haven't got very far with my Coach work. My SPD (teacher mentor) has been absent all week, and I haven't had any guidance or support on the course of action to take regarding the Coach project to implement at school... I'm overworked and overstressed as I've been pretty much thrown in the deep end at school with very little guidance or supervision due in part to the unfortunate timing of developments related to my SPD and events at school...I find it very frustrating to see how much can be done with a tool such as Coach, but how little in practice I can achieve given the circumstances (lack of means, guidance and momentum at school)*". Some teachers (mostly in CS1 and CS2) completed the lesson plan in hurry, so they could not send it to the course's teacher educator in advance for suggestions and improvement. Consequently, they did not really review the entire plan carefully or practice it before the classroom try-out.

Possibilities for teachers' classroom try-outs between Session 2 and Session 3 turned out to be influenced by many factors. First, room in the school physics or chemistry curricula for integration of certain ICT tools was limited. For instance, a teacher could not find any opportunity to integrate modeling activities in the chapter of direct current circuits which she was teaching in this duration. Second, dependent on progress of the curriculum, the try-out schedule of some teachers (CS1) could not be arranged before Session 3. Third, the school's agendas affected the try-out plan remarkably. For example, the intended time was at the end of the school year (CS2). The teachers rushed to complete all the lessons or prepare students for the final exam, so they hardly searched for room for the try-out.

About half of the teachers reported good support of the school for the incorporation of ICT in teaching practice. Here was an example, *"We have Coach Lab II+ and Coach lab mobile with specific science laptops with Coach software installed. The science department encourages the use of Coach software and my mentor was very positive about the use and continued use of the program and sensors"*. The other half complained about inconvenient conditions for ICT-IBSE try-outs in their schools. These schools lacked Windows PCs, Coach interface, and sensors; the teacher mentor did not have experience with the ICT tools. This was a circumstance shared by a teacher, *"For next year, the chemistry department is trying to get computers or tablets for in class, but at this point ICT in the classroom is about non-existent."*

c) How the blended set-up and support materials were useful to teachers' learning

In the post-questionnaire, we asked the teachers, "We applied a setting of 3 sessions spread over several weeks and major tasks in between the meetings instead of an intensive training in 3 consecutive days without tasks outside the course. - Which setting do you prefer?". 28 teachers (out of 33) reacted to this questions, and 20 of them preferred the blended set-up with life sessions and individual tasks in between. Following was a teacher's feedback, *"I prefer spread out sessions with tasks in-between. That gives me more time and occasions to practise the tool in a more realistic setting (that means doing what I really want to do with it without constant guidance). I get more time to think about what I really want to do and what kind of problems I really have and why. Then I can ask for appropriate help. With intensive training I always feel I'm doing what I'm told to do instead of what I will in actual fact want or need to do. The likelihood that I will afterwards actually use it is then much lower"*. In the blended set-up, teachers could learn in their own time and pace with preferred styles (e.g. following text/video instructions or trying and then fixing errors). There were 6 teachers who had no preference one way or another and 2 teachers who preferred the other set-up. A disadvantage of our blended set-up was pointed out by a teacher as follows: *"A longer period is the problem to keep your focus on course."* Moreover, activities intended for Sessions 2 and 3 are based on accomplishments of the individual tasks. Therefore, the teachers admitted that emails sent at certain moments during the course somehow to remind them about the tasks were very useful.

There were 7 teachers (4 in CS1, 3 in CS2) who were absent from Session 1 of the course, and 6 of them had a meeting with us for about an hour to catch up. We instructed them how to work with support materials. After that all of these teachers could follow the course and accomplished their classroom try-outs. Especially a teacher, who was absent from both Sessions 1 & 2, worked with us for 3 hours to practice with Coach video measurement, and then we introduced the form for the ICT-IBSE lesson plan. Eventually, she could manage to design and teach the lesson in which the given Coach video-measurement activity (i.e. falling of a shuttlecock) was applied as an interactive-demonstration. She completed the course requirements, although at a level which was lower than the others. These cases indicated that the support materials, especially the Coach activities and the form for the ICT-IBSE lesson plan, were very helpful for teachers' learning on their own. This result was in line with teachers' responses to the post-course questionnaire.

3.1.2 Effectiveness of the course – assessment of teachers' learning outcome

a) Level of awareness and motivation

The teachers pointed out different aspects of benefits of ICT tools for science education through the post-course questionnaire or life discussions. Here was a teacher's reflection, *"Using computers in general is a motivating factor for the lesson; the students enjoy the lesson more, and that increases their output of learning. Data logging is a very handy saving a lot of handwork to create graphs. Student get a nice graph after relatively little work, such positive experiences are stimulating. Video measurement is a lovely tool to answer every day question, e.g. how hard did Zlatan kick that ball? Modeling is more complex, but yields the biggest rewards as well. Once the students can understand most models, then concepts can become thoroughly fortified into their brains after modeling with them"*.

Becoming aware of the potential of ICT, teachers were soon motivated to learn further during and after the course. Teachers' eagerness of learning Coach in hands-on activities in Sessions 1 and 2 were clearly observable. Here is an example.

A teacher was inspired by a demonstration about Coach in Session 1 so that she asked us for a Coach activity of height measurement under control of a button, which could be used in her school's open day. We instructed her via email how to develop the activity which required many advanced skills, so it did not run well the first time. We continued to discuss back and forth via email. In time, she could manage to execute the experiment with students and parents. In Session 2, she confidently presented

the standalone setup: how to calibrate the ultrasound sensor, how to trigger via the light sensor, and how to analyze hundreds of data by histogram. She looked proud to share the satisfaction of parents and students' interest about her measurement. It was not difficult for her to answer questions from a fellow teacher. We did not require teachers to apply the tool as soon as she did in Session 2. In this instance, the teacher was motivated to learn, and she got quite advanced skills with the tool which she chose in such a short time.

Many teachers shared their willingness to learn and apply ICT tools after the course. Here was a teacher's thought, "*Actively wanting to learn to use Coach, since most teachers I've met (if not all) seemed to be so negative about it. I wanted to learn how to give students the opportunity to practical work beyond the (often very boring, uninteresting and far removed from their daily life and experience) classical lab practical and experiments that have been done through the years and that mostly populate the text books, physics websites and experiments' databases.*" Moreover, we asked teachers the following question via the post-course questionnaire, "In the course, you focused on learning to use and apply only one of the Coach tools (i.e. data logging, video measurement, or modeling) in IBSE. How confident are you in learning by yourself and applying the other tool(s)?" The gathered data (Figure 4) indicate that most of the teachers were confident to learn further and apply ICT tools in which they did not specialize during the course.

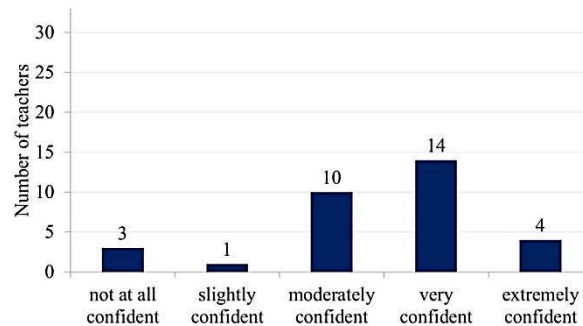

Figure 4. Teachers' confidence in learning ICT tools which they did not choose to learn in depth during the course

b) Level of technical mastery of the tools

Table 3. Familiarity of teachers with the tool they specialized in before and after the course and results of the Wilcoxon signed rank test and effect sizes

Groups of teachers who learnt the same ICT tool	Pre-course mean (SD)	Post-course mean (SD)	Statistic Z	Effect size		p
				Cohen's d	Pearson r	
Data logging (N = 18)	2.5 (1.15)	3.44 (.70)	2.804	.99	.47	.005
Video measurement (N = 21)	2.05 (.92)	3.05 (.86)	3.084	1.12	.48	.002
Modeling (N = 17)	2.59 (.87)	3.65 (.86)	2.846	1.23	.49	.004

The teachers reported about their familiarity with each of the three ICT tools before and after the course through a 5-point, rating-scale question: 1 = not familiar at all, 5 = extremely familiar. These data enable us to estimate changes in familiarity (with a certain tool) of teachers who chose to specialize in that tool further during the course. We categorized the data into three groups of teachers (considering three case studies together) who learnt the same particular tool: Data-logging (18 teachers), video-measurement (21 teachers), and modeling (17 teachers). The sum of numbers of teachers in these groups exceeds the number of participating teachers (33) in the three case studies because there were many teachers who studied more than one tool during the course. We applied the Wilcoxon signed-rank test to assess whether the familiarity of teachers (on average) to a particular tool (which they learnt) differ statistically before and after the course. The result was that the familiarity of teachers to the tool (they chose to learn) after the course was statistically significantly higher than that before the course as p values are all much smaller than .05, and the effect size is considered large: Pearson r values $\sim .5$ and Cohen's d values $> .8$ (Table 3). These increases in

teachers' familiarity with ICT tools were also observed in their Coach activities as well as in their work with Coach in life sessions and in the classroom.

To prepare the Coach activity for the ICT-IBSE try-out, the teachers had options of using one of the Coach subject activities (which we gave them as support materials) or modifying it to be more suitable for an inquiry-based lesson. These options suited teachers with just basic Coach skills. Furthermore, teachers were also encouraged to develop a new Coach activity with a strong inquiry component. However, developing a new Coach activity demanded from teachers not only a good idea and a feasible design of the activity but also advanced Coach skills and some experience with trouble shooting. Throughout the three case studies, 8 teachers (incl. 2 in CS1, 1 in CS2, and 5 in CS3) could develop their own, new Coach activities (Table 4) with little or no support from the teacher educator.

Table 4. List of teachers' newly developed Coach activities

Case study	Topics of newly-developed activities	Tools
CS1	1. Chemistry - Chemical equilibrium	Modeling
	2. Physics - Determining the shape of an object (using-ultra sound sensor)	Data logging
CS2	3. Physics - Temperature dependence of a resistance (using voltage and current sensors)	Data logging
CS3	4. Chemistry - pH calculation after dissolving HCl	Modeling
	5. Physics - Horizontally-launched projectile (using high-speed video)	Video measurement
	6. Physics - Resonance of a wine glass (using a sound sensor) (Figure 5)	Data logging
	7. Chemistry - Carbon cycle	Modeling
	8. Physics - Felix Baumgartner's supersonic fall from space	Modeling with real data

c) Level of application of ICT in IBSE

Before the course, the teachers had good knowledge about inquiry-based teaching, but little classroom experience. Eventually, 30 teachers (out of 33) could design an inquiry-based lesson plan which was integrated with a Coach activity. The lesson plans reflected teachers' understanding of inquiry-based teaching with clear descriptions about the lesson topic, students' prior knowledge, and objectives of knowledge and skills as well as details about what teachers and students would do in each inquiry phase. Coach activities were used at the relevant point of the learning process, supporting certain levels of students' investigations (e.g. open inquiry, guided inquiry, and interactive discussion with demonstration).

29 teachers implemented their lesson plans in the classroom. All lessons were videotaped, and most were observed by the first author. The try-outs were in a regular lesson with a whole class, a school project for a few weeks, or an extracurricular lesson with a small group of student volunteers. Teachers looked confident in teaching the lessons, and most of them did not meet any problems in manipulating with Coach. In the interview after the lesson or in the self-evaluation report, teachers could point out what went as intended and what were deviations in the implementation. Most of deviations were caused by the lack of teaching experience (e.g. time management, interaction with students). Some lesson plans turned out to be too ambitious as some content could not be covered, or students did not achieve some objectives. Many lesson plans were not implemented at the intended inquiry-level faithfully. However, most of the teachers were quite content with what they had done with the try-out because that was the first time they taught such an ICT-IBSE lesson. They were motivated to teach the lesson again with some revisions. One teacher was so inspired by effects of the course that she published her learning experience of designing and teaching an inquiry-based lesson with Coach modeling in the Dutch science-education journal, NVOX.

3.2 Technological and pedagogical problems of teachers in learning ICT for IBSE

3.2.1 Technological-science problems of teachers in using the ICT tool

In Session 1, we observed teachers' how-to issues in learning to use a certain Coach tool. They had to get over initial hurdles in learning a new tool, regarding new concepts (e.g. video measurement: frame, scale, time calibration, point tracking) and hands-on manipulations (e.g. modeling: connecting variables and constants). Many teachers could achieve basic technical mastery of the tool after a certain time by practicing

Coach tutorial activities. However, to understand or develop a complete Coach activity for students, teachers faced additional challenges such as proper understanding of concepts and mechanisms by which the tool measures, processes, or represents the related quantities. Following are three examples of teachers' technological-content problems, which corresponded to three different Coach tools and occurred at different moments in teachers' learning scenario.

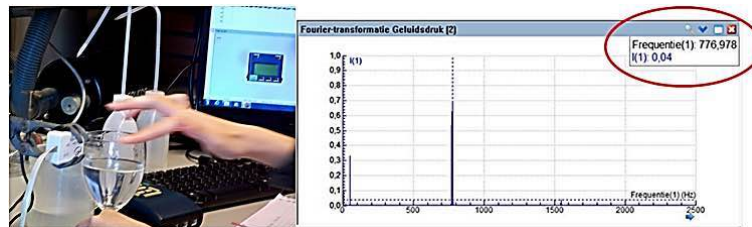

Figure 5. A Coach activity for measuring the frequency of resonance of a glass

A teacher designed an experiment (Figure 5) about resonance of a glass. He tried out the same set-up with two different measurement devices (incl. Coach), but got two different results for the resonance frequency. The Coach result looked incorrect. He struggled in checking the set-up, redoing several times, but still getting the wrong result. Eventually he asked us about this problem in Session 2. The resonance frequency was expected to be about 800 Hz whereas the sampling frequency in his measurement setting was only 50 Hz (default). We suggested him to increase the sampling frequency to 5000 Hz. Consequently, the Fourier transform of the sound signal yielded an acceptable value of the resonance frequency. In this case, the teacher managed to develop a new Coach activity, but he needed some experience of trouble shooting which requires the understanding of how Coach samples measurements.

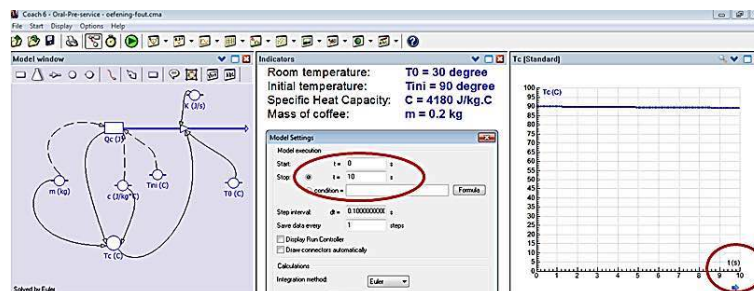

Figure 6. A Coach activity for modeling cooling of a cup of coffee

A teacher wanted to apply the given Coach model of cooling down a cup of coffee for her classroom try-out. However, she was uncertain if she could react properly to students' questions about Coach modeling, so she tried to recreate a model from a blank modeling window. When running the model, she got the unexpected graph in which temperature seemed to remain constant over time (Figure 6). She checked constants, variables, and connections carefully again to ensure that they were exactly the same as those in the given model. Executing the model again, she still got the "strange" graph, so she lost her confidence and emailed for help. In the given model, the execution time was set to one hour, so it produced a nice curve of temperature vs. time, decreasing from initial temperature to room temperature, then remaining constant. What she did not notice when reconstructing the model was the execution time, only 10 s (default). Therefore, the change of temperature was not visible in the graph. We suggested her to change the execution time, and then she could deal with the problem easily. The challenges to her were not only about getting familiar with technical details of the modeling tool, but also about learning to model a phenomenon, considering various issues such as concepts, laws of science, actual parameters. She had to learn both aspects. Through the close supervision via email, we helped her to overcome obstacles, and then she did progress further.

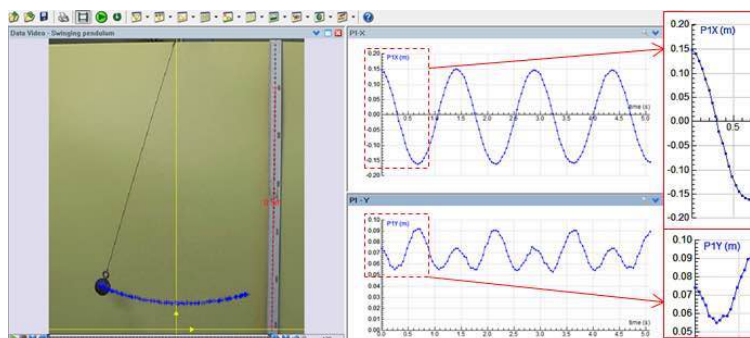

Figure 7. A Coach activity for measuring on a video of a pendulum with x vs. t above and y vs. t below

In Session 1, a teacher practiced the tutorial activity about measuring coordinates of a pendulum bob over time, and then plotting the graph of horizontal coordinate (x) vs. time. He predicted from theory that the y - t graph would also have the sine shape as the x - t graph, so he plotted the y - t graph as well. However, the y - t graph actually did not look as expected (Figure 7) whereas the x - t graph resembled a theoretical sine shape. He repeated the measurement, clicking on the central of the bob as precisely as he could, but the result did not change. He struggled with this problem for almost the entire hands-on time. Eventually, he asked for help. Errors in the measurement of x , y coordinates could not be avoided due to the actual set-up and manipulations such as spatial perspective, scaling, clicking on the central manually. Change of x (about 30 cm) was much larger than the error (about 1 cm), so the error was not seen clearly on the x - t graph. Meanwhile, change of y was only about 4 cm, so the error was not neglectable, and it was shown obviously in the y - t graph. The problem to the teacher was not the actual measurement, but the physics issue of how to interpret the data.

3.2.2 Pedagogical-science problems of teachers in teaching with the tool

In the Bachelor of Science and Master of Science programs, all teachers completed several university-laboratory courses and thesis work which required inquiry and laboratory skills. Moreover, in Sessions 1, 2 of our course the teachers studied the theory of inquiry-based teaching and how to develop an ICT-IBSE lesson. Teachers' knowledge about application of ICT into IBSE, therefore, was reflected in the lesson plans to some extent. However, pre-service teachers lacked practical knowledge and experience which they had to invent for themselves in their teaching situations. Thus, the demand of teaching a lesson integrated with ICT and IBSE components really stressed additional cognitive load on the teachers. To reduce complication of the task, we left ample options for the teachers to select which ICT tool was used to teach, what topic, at which level of inquiry. It was even possible for teachers to arrange just a part of the lesson with inquiry teaching, and other parts with direct instruction. However, the teachers still encountered didactical problems. Through classroom observations and videos, we found out that there was a big gap between intended inquiry activities in the lesson plan and actual realized inquiry in the classroom. Following are two examples.

Example 1:

In a regular lesson, a teacher provided ultra-sound sensors to groups of students and asked them to design an experiment to determine shapes of some hidden objects. However, he did not realize the implications of the fact that students were not really familiar with the sensor and the Coach software. The students did not come up with the idea of the experiment. Therefore, the teacher had to come to groups and explain the investigation problem, then raise detailed questions to involve students in the inquiry process. Consequently, although the plan was bounded inquiry, the implementation really was an interactive demonstration, not with a whole class as usual, but with each group of students. With more practical knowledge and experience he would have posed the investigation problem differently or would have been able to respond better to the implementation problems.

Example 2:

In a school project, a teacher assigned her students to design an experiment measuring capacitance through discharge of a capacitor. However, no matter the student accomplished the design or not, the teacher gave all students the same cookbook instruction to execute the experiment (with voltage, current sensors and circuit components). In fact, many students had not completed the experiment design when already receiving these instructions. To these students, the project was a cook-book

laboratory. Because of the desire that all students would complete the project with good reports, the teacher implemented her guided-inquiry lesson plan with much less inquiry than intended.

3.3 Revisions of the course set-up after each case study

Revisions after Case study 1

In life sessions of Case studies 2 & 3, we allocated more time for teachers' practice with Coach and mind-on tasks about inquiry teaching; and less time for plenary demonstration about Coach and lectures about IBSE. Teachers shared and discussed their individual work with small groups (CS2, CS3) instead of with the whole-class, so that every teacher could get detailed-feedback on her/ his tasks. The framework of inquiry-based teaching was introduced right from Session 1 (CS2, CS3) instead of Session 2 (CS1). Hence, the teachers could start thinking about the inquiry-based lesson earlier and start discussing this lesson plan and possibilities for its try-out in the school.

Revisions after Case study 2

About the time frame, Session 1 took place in a whole day (CS3) instead of a half day (CS1, CS2), and the time between Session 2 and Session 3 was extended considerably, 9 weeks instead of 3 weeks (CS1) or 4 weeks (CS2) to enable the teachers:

- To practice Coach with direct support from peers and trainers in Session 1. Hence, they could get over initial difficulties with the tool and progress much faster than practicing Coach alone at home.
- To arrange and execute their lesson plans before Session 3

About individual tasks, teachers were requested to read PPT slides about Coach and explore conditions for the classroom try-out in advance so that right in Session 1, they could already choose their tool for specialization. Moreover, the teachers had to complete a first draft of the lesson plan before Session 2, so in this session, they could complete it (CS3) with direct supervision from the teacher educator instead of just starting with finding some ideas (CS1, CS2).

Did the revisions work out?

From Case study 1 to Case study 3, the number of teachers who did not follow the suggestion of learning only one tool during the course decreased (i.e. 5 for CS1, 4 for CS2, 2 for CS3). There were fewer and fewer teachers who could not try out before Session 3 (i.e. 10 in CS1, 5 in CS2, 2 in CS3) (Table 2). In Case study 3, the teachers were quite satisfied with time distribution for each type of activities in life sessions. In addition, teachers in Case study 3 invested more time (17.1 hours) outside life sessions than those in Case studies 1 and 2. There were more teachers who developed new Coach activities for the ICT-IBSE lesson in Case study 3 (i.e. 5 compared to 2 in CS1 and 1 in CS2). The classroom try-outs in Case study 3 were implemented more faithfully than those in Case studies 1 and 2. In conclusion, the revisions of the course after each case study worked out as intended.

4 Conclusions and discussions

4.1 Conclusions

The teachers' learning scenario (incl. life sessions and individual tasks) was implemented quite faithfully. The activities intended for life sessions were covered and executed fairly smoothly. There were obstacles to teachers in designing and teaching an ICT-integrated inquiry-based lesson such as their demanding workload, limited room in the curricula, dependence on the school agenda, or lack of needed ICT infrastructure. Therefore, many teachers could not try out their lesson plans before Session 3 as intended. The teachers spent a reasonable amount of time outside life sessions for individual tasks, using support materials and online assistance. Eventually, most of the teachers (29 out of 33) fulfilled the complete cycle of designing, implementing, and evaluating an ICT-IBSE lesson in the classroom. The Coach activities for practicing ICT skills and the lesson-plan form for preparing an ICT-IBSE lesson were essential and useful for teachers' learning during the course.

Within a limited time, three heterogeneous groups of pre-service teachers achieved a reasonable level of competence regarding the application of ICT tools in inquiry-based lessons. Being aware of potential benefits of ICT tools and of carrying out individual tasks, the teachers were soon motivated to learn further during and after the course. After the course, teachers' familiarity with the tool which they chose to specialize in was significantly higher than that before the course. Most of the teachers did not meet any difficulties in

manipulating the ICT activity in the classroom try-outs. Some teachers (8 out of 33) could develop their own, new ICT activities which required new ideas and advanced skills with the tool. Teachers' lesson plans reflected their knowledge of incorporating ICT into IBSE, but some were too ambitious, so just part of learning goals were achieved in the classroom. Teachers' efforts to implement the lesson plan indicated different possible contexts for application of ICT into IBSE such as a regular lesson with a whole class, a school project for a few weeks, or an extracurricular lesson with a small group of student volunteers. Although most of the teachers were confident in executing the lesson plan, there was still a considerable gap between intended inquiry activities and actual realized inquiry. However, the teachers were able to evaluate the lesson after the tryout, and most of them felt confident to learn other ICT tools (which they did not specialize in during the course) on their own after the course and apply these tools in the inquiry-based lesson.

In addition to objective difficulties from external factors (e.g. time constraints, teaching conditions), the teachers struggled with problems regarding their conceptual understanding and experience about ICT, inquiry-based teaching, and science. First, many teachers had to get over initial hurdles in learning an unfamiliar tool (e.g. video measurement or modeling) such as new ICT concepts and how-to issues of particular manipulations. Considering the tool in the whole laboratory activity, the teachers faced further challenges which required proper understanding of the phenomenon (i.e. concepts, laws, and events) as well as knowledge of how the tool collects (or models) information (about the phenomenon) and of how it then processes and represents these data. They also needed trouble-shooting experience to deal with these types of problems. Second, many teachers came across problems in executing the ICT-IBSE lesson plan in the real classroom environment. In addition to the lack of practical knowledge (e.g. time management, interaction with students), the teachers needed experience of getting students to focus on inquiry and concept learning in the classroom, which is a typical problem of beginning (and experienced) teachers (Abrahams & Millar, 2008).

In the learning scenario, Sessions 1 and 2 were to prepare the teachers to be able to master technical skills (Task 1) and to teach an inquiry-based lesson with the ICT tool (Task 2). Meanwhile, activities on Sessions 2 and 3 were based on accomplishments of the two successive tasks. Many teachers got frustrated with technical problems in manipulating the ICT tool at home. In addition, arranging and teaching an inquiry-based lesson with the ICT tool turned out to be very demanding and time-consuming. Therefore, main revisions of the course throughout the three case studies were to adjust activities in life sessions and the time frame in order to make teachers' individual tasks more feasible and endurable. For example, we allocated more time for hands-on, in-group activities and less time for theory, plenary activities in life sessions so that the teachers could earlier specialize in their individual issues (i.e. practicing ICT skills, preparing the lesson plan) and consequently, progress faster because of in-time, direct support/ feedback from the teacher educator. Spending a whole day for Session 1 (instead of a half day), the teacher could get basic skills with the ICT tool which would enable them to troubleshoot their difficulties (in working with the tool) themselves. Moreover, the IBSE framework was introduced right from Session 1, so the teachers could start to design and complete the first version of the lesson plan before Session 2 (shifting the first part of Task 2 forward). The duration for Task 2 was extended considerably, so the teachers could find room for arranging and executing their lesson plans before Session 3. These revisions worked out as the course was implemented more faithfully and effectively in Case study 3.

4.2 Discussion

Integration of technology into science education is a need globally recognized, and the teacher is the key factor for the practical technology-incorporation in the classroom. This study, therefore, aimed at development of a course on this TPACK domain which can be integrated in the teacher-education program. From the theoretical exploration, we defined the three principles (Section 1.2) underlying the course design, following which teachers are encouraged to become aware of possibilities of all three ICT tools, but then specialize in one tool by choice (*depth first*) through a complete cycle of designing, teaching, and evaluating an inquiry-based ICT-integrated lesson in the classroom. The classroom application of what teachers learn in life sessions might enable them to experience and appreciate various aspects of integration of ICT into IBSE (passing over threshold). This also requires a blended set-up for the course, including life sessions (as in a traditional course) and individual tasks outside life sessions in which the teacher work with sufficient support materials and online assistance. Success in an in-depth complete cycle with one ICT tool might bring teachers' expertise and inspiration to learn others on their own (*breadth later*). Outcomes of the three case studies proved that these three principles are suitable to the Dutch boundary conditions in which the time for

pre-service teachers' learning is very limited, and their backgrounds and teaching conditions are very heterogeneous.

The design-based research framework (Figure 1) proved to be suitable to the development of the course. This approach guided us to elaborate design principles (defined from theoretical exploration) for the teachers' learning scenario taking into account the boundary conditions. The three iterations of (re)constructing, executing, and evaluating the course helped to optimize the faithful implementation and effectiveness of the course in the Dutch context. We recommend the course's learning scenario with the support materials and developed assessment instruments to teacher educators who are going to prepare their pre-service teachers to apply technology into science education in the Netherlands. For a broader perspective, we have been investigating applicability of the design principles and support materials in other countries (i.e. Slovakia and Vietnam) with adaptations geared to a different local, educational, cultural context. The outcomes of the additional case studies at the international level may reveal some limitations of the course in the Netherlands and also provide recommendations for adaptations to other contexts and countries. The conclusions and discussion above were based on data from teachers' learning with the Coach platform, but easily transferrable and valid for other platforms.

Acknowledgements

Development and delivery of the course was carried out with the support of the ESTABLISH project, Foundation CMA and with the cooperation of teacher educators, pre-service teachers from VU University Amsterdam, Utrecht University, University of Amsterdam, and Delft University of Technology. The course materials were developed by Ewa Kedzierska, Vincent Dorenbos, Ron Vonk, Ton Ellermeijer (CMA), Zuzana Ješková, and Marian Kires (University of Kosice). The course was taught by Vincent Dorenbos, Ron Vonk, Ewa Kedzierska, Ton Ellermeijer (CMA), and Ed van den Berg (VU).

References

- Abrahams, I., Millar, R. (2008). Does practical work really work? A study of the effectiveness of practical work as a teaching and learning method in school science, *International Journal of Science Education*. 30(14), 1945-1969.
- Berg, E. van den (2013). The PCK of Laboratory Teaching: Turning Manipulation of Equipment into Manipulation of Ideas, *Scientia in educatione*. 4(2), 74–92.
- Guskey, T. R. (2002). Does it make a difference? Evaluating professional development, *Educational Leadership*. 59(6), 45-51.
- Heck, A., Kedzierska, E. and Ellermeijer, T. (2009). Design and implementation of an integrated computer working environment for doing mathematics and science, *Journal of Computers in Mathematics and Science Teaching*. 28(2), 147-161.
- Knippels, M.C.P.J (2002). *Coping with the abstract and complex nature of genetics in biology education: The yo-yo learning and teaching strategy*. PhD dissertation in University of Utrecht, The Netherlands.
- Koehler, M., Mishra, P. (2005). What happens when teachers design educational technology? The development of technological pedagogical content knowledge, *Journal of Educational Computing Research*. 32(2), 131–152.
- Shulman, L.S. (1986). Those who understand: Knowledge growth in teaching, *Educational Researcher*. 15, 4–14.
- Tran, T. B., van den Berg, E., Ellermeijer, A. L. and Beishuizen, J. (2014). Development of a pre-service course on integration of ICT into inquiry based science education. *Proceedings of the ICPE-EPEC International Conference on Physics Education*, The International Commission on Physics Education, 629-642. http://www.icpe2013.org/uploads/ICPE-EPEC_2013_ConferenceProceedings.pdf

Affiliation and address information

Trinh-Ba Tran
 Department of Research and Theory in Education
 Faculty of Psychology and Education

VU University Amsterdam
Van der Boechorststraat 1
1081 BT Amsterdam, THE NETHERLANDS
e-mail: b.t.tran@vu.nl

Learning Assessment about the Moon's Synchronous Rotation Mediated by Computational Resource

Adriano Luiz Fagundes¹, Tatiana da Silva², Marta Feijó Barroso³

¹ *PPGECT/Universidade Federal de Santa Catarina*

² *Physics Department and PPGECT/Universidade Federal de Santa Catarina*

³ *Physics Institute/Universidade Federal do Rio de Janeiro*

Abstract

The evaluation results of the use of a learning object contained in an educational hypermedia named "Phases of the Moon" are presented in this paper. The educational material was applied to 77 students in a non face-to-face moment of an undergraduate introductory physics discipline of a STEM course. The learning outcomes on the concept of Moon's synchronous rotation were obtained from quantitative and qualitative analysis of student's responses before and after the developed learning activities. They are expressive. A comparison between the pretest and the learning assessment results provides a learning gain of 50%. The effectiveness of the animation as a visualization object and thus as a facilitator in the learning process of the underlying phenomenon is inferred through a qualitative analysis of the assessment tools and the instructional material characteristics.

Keywords

animations, visualization objects, learning assessment, synchronous rotation, science education.

1. Introduction

It is understood that each individual perceives the outside world in a different way by creating his or hers own mental representation about what is experienced through its senses. The idea that the mind works through mental representations and cognitive processes which operate on these representations, is a central assumption of studies in the cognitive psychology field. Therefore, it is important to distinguish some terms that are used with different meanings. According to Vavra et al (2011) the word visualization can have three meanings: visualization objects, introspective visualization and interpretive visualization. The first one also named visual resource is a physical object to be viewed from the world outside. The second, the introspective visualization, refers to the mental object created by a particular person in its mind. And the third, the interpretive visualization, refers to the active cognitive process, the interaction between mental object and knowledge previously experienced by the individual. These definitions are adopted here and the computational resource evaluated is considered a visualization object.

From this central hypothesis, it is assumed that the use of visualization objects can assist in introspective visualization favoring the interpretation and learning. The use of static images, animations, simulations, and other resources under certain conditions may provide help and guidance to students in interpreting various contents making them effective teaching tools.

An interesting context where the use of these materials is helpful in the interpretation and explanation of phenomena is in astronomy education. The synchronous rotation of the Moon is a good example. From the Earth's reference frame it's very difficult to explain why we always see the same face of our satellite since it demands: change of reference frame, the observation of the geometry of the phenomenon and also the decoupling of Moon's rotational and translational movements.

Although justifying the need to use such resources, it is not always clear whether the educational objectives will be achieved. Therefore, it is important to evaluate and analyze their use in real learning contexts, for instance applying assessment tools before and after the use of visual resources, in search for evidence of its effectiveness or failure. This evaluation requires understanding how computer-mediated learning happens. Starting from the assumption that learning really depends on the quality of teaching resource, namely its characteristics, one can investigate how to better present the information on a given disciplinary content. There are a number of research papers that investigate and compare the use of animations and static images for teaching specific contents. There are also studies evidencing that the interactivity, the amount of information, the control of sequencing information (pacing), among other characteristics, influence leanings

outcomes. Some research papers, however, depart from the assumption that prior knowledge or individuals expertise defines how they interact or interpret the content presented and that this factor may influence the results more than the characteristics of the material. This is a pertinent discussion and it is possible to consider aspects of both approaches in the elaboration, use and evaluation of computational resources designed as visualization objects.

2. Theoretical framework

The cognitive load theory (CLT) (Sweller, 2002 and 2008) adopts the hypothesis that cognitive processing is dependent on the interaction between teaching resource and knowledge previously acquired by individuals. And that working memory, the center of the human cognitive process, is limited in its ability to process information. This theoretical framework allows the assumption that both, the characteristics of the visual resources as well as individual differences, can influence computer-mediated learning.

With respect to the characteristics of the visualization object, the dynamics of the information flow is relevant and must be considered. Recent studies often compare different screens to verify the advantages of using each one in teaching a particular content or concept. Hegarty (2004), for example, differentiates the way the information is presented in the computational resources as static displays (graphic, text, image), non-interactive-dynamic displays (movie, simulation, animation) or interactive-dynamic displays (film, simulation and interactive animations, hypermedia). Non-interactive-dynamic resources can produce unwanted cognitive demands, because the sequencing of information not controlled by the learner may impose a high demand on its working memory, making the learning process difficult. Give the apprentice the control of information flow can be a way to overcome the problem of transition in dynamic displays. Hoffler and Schwartz (2011) investigate the control effects of the passage of information (pacing) and cognitive styles through the use of static screens (images) and dynamic screens (animations) in the teaching of a chemical reaction. The authors find that the learning outcomes are better for the static screen use when the learner does not have control of the information pacing and dynamic screen when is given to the learner the control of the sequence of information. The learning object evaluated in this study represents a dynamic screen in which the learner has the control of the presentation of information.

Regarding the differences between individuals, the student's content knowledge can also strongly influence the learning outcomes, determining how each learner interacts with the visualization object. According to Sweller (2008), instructional procedures adopted in an educational resource aimed at helping students with no or little knowledge in a given subject cannot be effective or can even hinder learning from those with more expertise in this subject content. This means that adopted procedures to guide students with less experience in the content presented may become redundant or insignificant for those with a higher level of expertise in the subject content. Therefore, an analysis of the results of the use of a teaching resource requires checking the impacts in those with less and those who had correct prior knowledge of the content before the instructional process.

3. The computational resource

The computational resource evaluated is an animation about the synchronous rotation of the Moon (Figure 1) which is part of the hypermedia "Phases of the Moon". The animation evaluated version corresponds to an old version available in the link <http://tati.fsc.ufsc.br/webfisica/sis-solar/fasesdaluha.htm>.

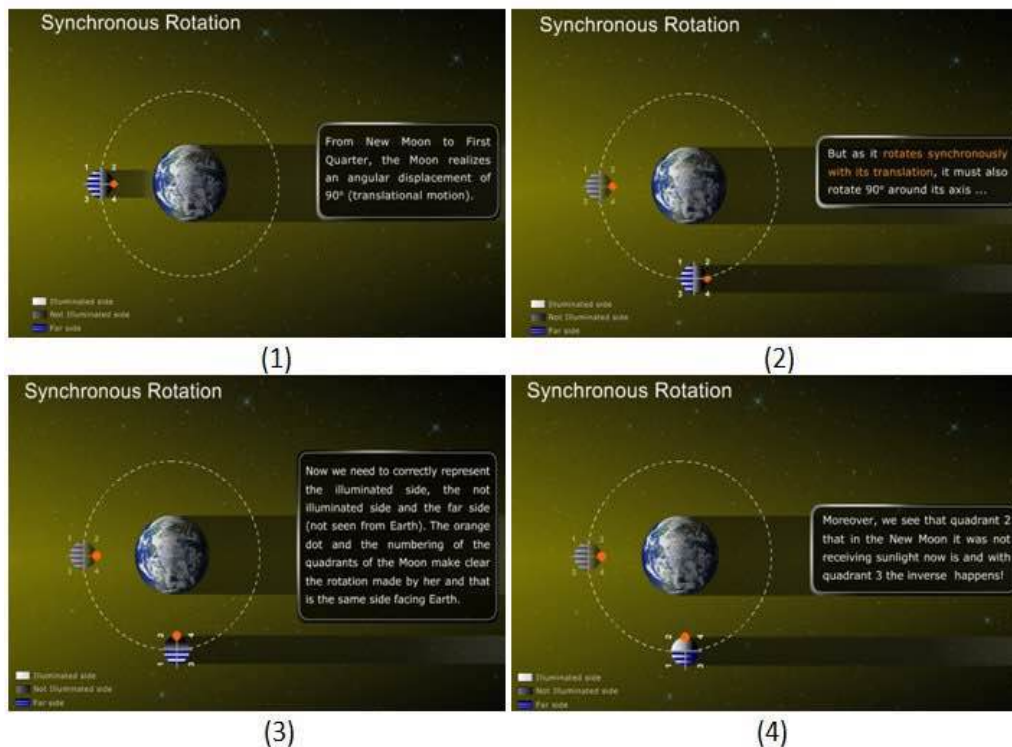

Figure 1. Static images from the animation sequence shown in the hypermedia screen. The images were taken from the address: http://tati.fsc.ufsc.br/caronte/fasesdalua/ingles_rotacaosincrona.html.

But the learning object about synchronous rotation itself has not changed in concept from the upgraded version shown in Figure 1 to the old one. The improvement is in language since it is accessible also in English and in French.

The discussion of synchronization between the rotation and the translation of the Moon is performed in a dynamic scheme which decouples the two movements presenting them sequentially rather than simultaneous. Besides, is given to the student the control of the pacing of information using the buttons "back" and "forward". It is understood that this strategy facilitates the learning process of this phenomenon, especially for those who have little or no knowledge of this subject, since by showing both translation and rotation at the same time makes it difficult the perception of the Moon's rotation around its axis which is associated to the complexity of the content (intrinsic cognitive load). Another instructional strategy adopted is the representation of the Moon divided into four quadrants, each one numbered from 1 to 4 and the highlight of its side facing the Earth. In this animation the illuminated, the not illuminated and the unseen sides are also shown. The illustration enables to perceive that all sides of the Moon receive light from the Sun, depending only on their relative position. The sequence is shown in Figure 1. One can note that there is a link between verbal and non-verbal languages, because each step of the animation is accompanied by verbal explanations in a frame which is integrated to the figure according to the instructional design principles of CLT.

4. The context

The learning object was used in 2011 on an undergraduate physics introductory discipline of a course on natural sciences and mathematics (STEM) offered by a federal educational institution. The students were in their first term. In this discipline different physical contents are approached with visuals resources (DUTRA and BARROSO, 2013). The content of the discipline is divided into units and the discussion of astronomical phenomena is part of the second unit worked after the discussion of geometrical optics. The use of the hypermedia material was proposed in blended character, which means the students used the animation autonomously without the presence of the discipline teacher (SILVA and BARROSO, 2008). Students first completed a pretest on astronomical phenomena in a virtual learning environment (Moodle) as extra work, and it was guaranteed computer access for all of them in the multimedia room of the institution with tutored support. After certain period of time given to browse the hypermedia material, a learning assessment was held and it significantly influenced the grade given in the discipline.

5. Evaluation methodology

The questions used in the pretest and learning assessment regarding the synchronous rotation of the Moon were:

- *You hear the following comment: "The Moon rotates around its axis in a way that always presents the same face toward the Earth". Do you agree or not? Justify.*
- *The Moon always presents the same face toward the Earth? Draw a diagram to explain your answer.*

The results were analyzed using descriptive analysis techniques and open-ended responses were analyzed using reduction and simple categorizations.

In the pretest the students' verbal explanations were assessed and it was found that the agreement or disagreement shown in their answers with the statement presented in the question was uncorrelated to the given justification. The researches interpreted as demonstration of unfamiliarity with the phenomenon.

The categories of analysis drawn up from the responses were: correct (the ones which describe that Moon's rotation around its axis has the same period of its translational motion around the Earth), incomplete (those which contain sentences associated with synchronous rotation as described above as a correct explanation but lacks information in order to make them complete and correct explanations) and incorrect (the ones with arguments that are not associated with synchronous rotation or do not explain the occurrence of the phenomenon). When considering only the explanations categorized as incorrect, we also identify three types of misconceptions regarding the well-defined phenomenon which are: the Moon without rotation, dependence on Moon movements with the Earth's rotation and the confusion with the phases of the Moon.

In the learning assessment, unlike in the pre-test, it was found that most students used diagrams and verbal explanations, so the two response formats (verbal and non-verbal) were accepted. However, to enable also qualitative analysis, diagrams and verbal explanations were categorized separately and combined when necessary to evaluation purposes as correct, incorrect, incomplete and inconsistent answers.

The diagrams were categorized as: "animation-like" (diagram considered as correct that contains an schema similar to the one used in the hypermedia's animation to demonstrate the synchronous rotation), "self-diagram" (diagram considered as correct to show the synchronous rotation using a scheme created by the student which means it is different from the quadrants schema shown in the hypermedia's animation), "incomplete" (this kind of diagram does not show the same face of the Moon facing to the Earth along with its translational movement, but represents the rotational and translational movements of the Moon) and "incorrect" (it is a diagram which shows an asynchronous rotation of the Moon or when the diagram is not shown). In Figure 2, we present examples of "self" and "animation-like" diagrams:



Figure 2. Left: self-diagram. Right: animation-like diagram.

When considering the responses in the learning evaluation we identified the ones with a diagram schema and/or verbal explanation, as well as we identified cases of contradictory responses between the two formats. Some students presented correct diagrams followed by incorrect verbal explanation, while others have made the opposite. Such cases were categorized as "incoherent". The criteria used to categorize verbal explanations in the learning evaluation question were the same as those used for the pretest question.

After the analysis procedures described above, we compared the results obtained in the pretest and in the learning assessment, presenting the average performance of students in each of these evaluative stages. Grades from 0 to 2 for each response category were awarded. Incorrect answers were graded 0, incomplete responses graded 1, incoherent 1.5 and correct answers graded 2. And then, we calculated the average percentage gain G (CABALLERO et al, 2012) in order to infer quantitative changes of learning by comparing student's performance before and after instruction. As this quantity gives an overall result, we

searched to understand it qualitatively as well with the aid of a contingency table. Thus, we present in a qualitative manner the evolution of student's performance from an evaluation stage to another, seeking to characterize the learning quality provided by the use of the animation. It is desirable that the use of the computational resource fosters improvements in learning of the ones who have not mastered the topic and do not change the performance of those with prior correct knowledge. Analyzing the answers from this point of view enabled to reach to three classifications according to the comparison performed between pretest and learning assessment:

- Positive effect - learning improvements are identified after use of the material. Students who do not respond correctly in the pretest but answer correctly in the learning assessment.
- Neutral Effect - changes are not identified after the use of material. In other words, they are students who answer correctly in the pretest and continue answering correctly in the learning evaluation or students who respond incorrectly or incompletely in the pretest and continue answering incorrectly or incompletely in the learning assessment.
- Negative Effect - students who answer correctly at the pre-test and fail to respond correctly in the learning assessment.

6. Results

The results obtained in the pretest and in the learning assessment are presented in Table 1.

Table 1. Frequency of analysis categories of the pretest and learning assessment

Category	Pretest		Learning Assessment	
	Frequency	Percentage (%)	Frequency	Percentage (%)
Correct	10	13	44	57
Incomplet	9	12	6	8
Incorrect	58	75	20	26
Incoherent	-	-	7	9
Total	77	100	77	100

It is observed that the majority of students, 58 (75%) answered incorrectly in the pretest. Only 10 (13%) answered correctly demonstrating scientific knowledge about the phenomenon before using the visualization object. Among the responses categorized as incorrect, approximately half of them have no scientific answers clustered into three well-defined categories: 12 (21%) answered that the Moon has no rotational motion, 13 (22%) replied that this phenomenon depends on the rotation of the Earth and 7 (12%) confused this phenomenon with the phases of the Moon. Even within this universe, 14 students (24%) explained that since the Moon has rotational motion, there is no possibility of visualizing from the Earth always the same Moon's face. This latter explanation may be well understood as being *logical*. If a body has rotational motion, how can it be possible to present always the same face to a given point? It is assumed the hypothesis that this type of response is associated to the difficulties related to the interpretative visualization, since only a change in reference frame locating the observer outside the Earth or through the use of an analogy with a movement familiar to the learner, can make it possible to realize that a body may rotate around itself (rotation) while it rotates around another body (translation) without showing all of their faces. Therefore, for the learning process on synchronous rotation of the Moon, it is important to present the methodological strategy of decoupling the rotational and translational movements of Moon something that encounters support in cognitive load theory (CLT) since it is linked to the complexity of content (intrinsic cognitive load). Thus, the use of a visualization object should contribute to help these individuals in learning this concept and more, in helping them to represent and to change observations according to the frame of reference.

There is a significant increase from 13% to 57% in correct answers, while we observed a reduction of 75% to 26% of incorrect answers. According to Table 1, it is identified only 7 (9%) cases of incoherence in the learning assessment.

In order to obtain the average performance of students in the pretest and in the learning assessment it was

given scores between 0 and 2 for the response categories. Table 2 presents the mean scores of students in each evaluative stage. As explained, incorrect answers received grade 0, incomplete answers received grade 1, incoherent were graded as 1.5 and correct answers as 2.

Table 2. Mean and standard deviation for student's performance in the pretest and learning assessment.

Evaluations	Number of Students	Minimum Score	Maximum Score	Std.	
				Mean	Deviation
Pretest	77	0,0	2,0	0,37	0,70
Learning assessment	77	0,0	2,0	1,36	0,90

By analyzing Table 2, one can observe a significant improvement in student's average grade. From the mean one can obtain students performance at the two steps and calculate the average percentage gain (G) which was equal to 50% as shown in Table 3. It may be noted that it is a significant value which characterizes the optimal result obtained after the autonomous use of the hypermedia by students. As mentioned before this learning object can be classified as a dynamic interactive screen and has been pointed by Hoffler and Schwartz (2011) as an effective way to present information for a computer-mediated learning resource.

Table 3. Average percentage gain.

Average percentage gain		
Learning assessment	$O = \text{Mean} / \text{Maximum Score}$	0,68
Pretest	$I = \text{Mean} / \text{Maximum Score}$	0,18
Gain	$G = (O - I) \times 100\%$	50%

After studying these general results, the effects on students that already had some prior knowledge on the subject and on those that had little or no prior knowledge were analyzed. Table 1 was reorganized as shown in Table 4, where these effects could be better seen. The detailed analysis realized with the students that have shown in the pretest that they do not understand the phenomenon of synchronous rotation (incomplete and incorrect answers), 36 (47%) of them demonstrate a scientifically accepted knowledge after the use of the interactive animation, they were classified as Positive Effect (+). It was also found that 51% of learning outcomes fits as Neutral Effect (*), such are the cases where there is no change in students knowledge. And there are only two cases (3%) tagged as Negative Effect (-) in which students answered correctly in the pretest and unfortunately turns out to answer incorrectly (1) and inconsistently (1) in the learning assessment. In the group classified as Positive Effect, there is a specific subgroup of 14 students (39%) who responded incorrectly in the pretest because they highlighted the fact that since the Moon has rotational motion, all its faces must be viewed. Among these students, 12 (86%) respond correctly in the learning assessment. These results can be interpreted as a strong evidence of the effectiveness of the interactive animation as a visualization object. Such findings are understood and related to the instructional design procedures adopted in the elaboration of the visual appeal suggested within CLT: the observation of the phenomenon from a privileged reference point, the decoupling of translational and rotational motions of the Moon both related to the complexity of the content (intrinsic cognitive load), the quadrants model which gives to the student a model to deal with (borrowing principle) and the control of the information pacing in order to reduce extraneous cognitive load.

Table 4. Contingency analysis between pretest and learning assessment.

		Learning assessment				
		Correct	Incomplet	Incorrect	Incoherent	Total
Pretest	Correct	8 (*)	0	1 (-)	1 (-)	10
	Incomplet	6 (+)	1 (*)	2 (*)	0	9
	Incorrect	30 (+)	5 (*)	17 (*)	6 (*)	58
	Total	44	6	20	7	77

7. Final Remarks

The use of an animation in which the student controls its pacing (dynamic interactive screen) was evaluated using a blended model. The learning object is about Moon's synchronous rotation. 77 students were enrolled in the assessments stages. The comparison between the assessment tools provides results with a significant improvement in the average grade of the students and an average gain of 50% after the use of animation is achieved. With respect to aid for the visualization of phenomena, the large number of correct diagrams in the learning assessment comprises a strong indication that this digital material can serve as a visualization object promoting a privileged observation of the phenomena and assisting students in constructing coherent mental representations. Nevertheless, the use of visual aid does not adversely interfere with the performance of those students (8) in Table 4 who have demonstrated knowledge about the phenomenon before the intervention process. The results of this research together with the references adopted regarding to the role of interactivity in the learning process through digital materials, made it possible to elicit characteristics of the material that may explain their potential to assist learning. Nevertheless, these are hypotheses that need a deepening in research.

References

- Caballero, M. D., Greco, E. F., Murray, E. R., Bujak, K. R., Marr, M. J., Catrambone R., Kohlmyer M. A., Schatz, M. F. (2012). Comparing large lecture mechanics curricula using the Force Concept Inventory. *American Journal of Physics*. **80**, 638-644.
- Dutra, L. M., Barroso, M. F. (2013). Uso de experimentos como ferramenta de ensino e aprendizagem: estudo de um caso. *Proceedings of XX Simpósio Nacional de Ensino de Física*, São Paulo.
- Hegarty, M. (2004). Dynamic visualizations and learning: Getting to the difficult questions, *Learning and Instruction*. **14**, 343-351.
- Höffler, Tim N., Schwartz, Ruth N. (2011). Effects of pacing and cognitive style across dynamic and non-dynamic representations, *Computers and Education*. **57**, 1716-1726.
- Silva, T. (2012). Um jeito de fazer hipermídia para o ensino de Física, *Caderno Brasileiro de Ensino de Física*. **29**, 864-890.
- Silva, T., Barroso, M. F. (2008). Fenômenos Astronômicos e Ensino a Distância: Produção e Avaliação de Materiais Didáticos, *Proceedings of XI Encontro de Pesquisa em Ensino de Física*. Curitiba.
- Sweller, J. (2002). Visualisation and instructional design. *Proceedings of International workshop on dynamic visualizations and learning*, Tubingen, Germany: Knowledge Media Research Center.
- Sweller, J. (2008). Human Cognitive Architecture. In *Handbook of research on educational communications and technology* (pp. 369 -381). New York: Routledge.
- Vavra, K. L., Janjic-Watrich, V., Loerke, K., Phillips, L. M., Norris, S. P., Macnab, J. (2011). Visualization in science education, *Alberta Science Education Journal*. **41**, 22-30.

Affiliation and address information

Adriano Luiz Fagundes
 Master in Education - PPGECT (Post-graduation Program in Science and Technology Education)
 Federal University of Santa Catarina (UFSC)
 Trindade, Florianópolis, SC, Brazil
 e-mail: adrianoitajuba@gmail.com

Tatiana da Silva
 Physics Education Research Group (UFSC)

Laboratory for Research and Development in Mathematics and Science Teaching- LIMC (UFRJ)
Post-graduation Program in Science and Technology Education - PPGECT
Physics Department (FSC)
Federal University of Santa Catarina (UFSC)
Trindade, Florianópolis, SC, CEP: 88040-900 , Brazil
e-mail: tatiana.silva@ufsc.br

Marta Feijó Barroso
Laboratory for Research and Development in Mathematics and Science Teaching- LIMC
Professional Masters Degree Program in Physics Teaching - MPEF
Physics Institute (IF)
Federal University of Rio de Janeiro (UFRJ)
Centro de Tecnologia - bloco A - Cidade Universitária
Rio de Janeiro - RJ - CP: 68528 - CEP: 21941-972 , Brazil
e-mail: marta@if.ufrj.br

Using Technology to Provide an Interactive Learning Experience

Kyle Forinash, Raymond Wisman

School of Natural Sciences

Indiana University Southeast

New Albany IN, 47150, USA

Abstract

Most pedagogical material found on the Internet today is still very passive; merely electronic versions of books, notes and other traditional learning material, little changed from before the Internet. In this paper we will describe two interactive, online text books one of us (Forinash) has written that use simulations to engage students in active learning. We will also briefly describe other work we have done involving real (as opposed to virtual) student laboratory experiences outside the classroom using mobile devices such as tablets and smart phones.

Keywords

Interactive media, ebooks, smart phones, tablets, mobile devices.

1. Interactive?

Gutenberg's invention of movable type around 1450 did not revolutionize the content or the format of the information being provided. It did have the important consequence of speeding up and broadening access to information. In a similar way, much of our modern technology, especially the Internet, has accelerated and expanded access to the world's knowledge base. Instructors today routinely provide a course syllabus, course information, instructor notes, assignments, sample tests, supplementary reading, and web links to other material, all online using a course management system or simple web pages. Many university students now receive access to a PDF version of the course textbook when they register for a course.

These uses, however, are *not* interactive. Much like an enhanced printing press, this technology serves to accelerate the one way transfer of material from the instructor to the student. In this regard it is not much different from what was already being done 560 years ago by Gutenberg; the information flow is unidirectional, albeit much faster. While, in hindsight, Gutenberg's creation was seminal to mass education, the communications revolution of the past century has yet to produce comparable improvements in human learning. However, today's technology, the Internet in particular, has the capacity to function much more interactively in a bidirectional and even multidirectional way.

What do we mean by interactive? Email, group email, chat rooms, web feedback pages, clickers, QR codes, and interactive whiteboards are all two-way communication tools using technology adaptable to education. Some classes on our campus require students to create collaborative knowledge bases such as wikis, class web sites and blogs which are multi-participatory. Contributions to a web site about environmental issues have been a requirement for an upper-level environmental physics class taught by one of us for eight years and the students always rate this as a valuable part of the course in end of semester student evaluations. One of us has taught a philosophy of science course where students could anonymously post an essay for other students to comment on before making final revisions for submission for a grade, thus taking advantage of peer review and a type of crowd sourcing (student response was very enthusiastic). Pre-lecture, online quizzes are a great way to make sure students at least look at some of the course material outside of the classroom and come to class prepared. They also provide valuable feedback to the instructor so that classroom presentations can be tailored to the level of the students. Post-lecture online quizzes and online homework allow the instructor to assess whether the students are keeping up with the material being presented. PodCasts and VodCasts of classroom presentations are ways for students to review material at their own pace.

2. What about the textbook?

In introductory physics (which one of the authors teaches), there are several alternatives for an online textbook, each with differing degrees of interactivity. The *Textbook Equity* site

(<http://textbookequity.org/category/physics/>) allows users to download, modify and use several different versions of introductory physics books. The instructor can use as much or little of the book as they deem useful and can customize the text to the course they are teaching. *Openstax* (<http://openstaxcollege.org/>) and *Flatworld* knowledge (<http://catalog.flatworldknowledge.com/>) offer similar products that have been designed by professional development teams.

Another alternative is to do away with a textbook entirely and simply use video lectures found on YouTube, Khan Academy (<https://www.khanacademy.org/>) or other sites. This provides a more interactive presentation of the material and makes a flipped classroom possible where the students view the lecture outside of class and come to the classroom ready to solve problems and actually ‘do’ physics.

Going up the scale of interactivity we come to offerings such as *Hyperphysics* (<http://hyperphysics.phy-astr.gsu.edu/hbase/hph.html>), an online textbook which allows the reader to jump around to different topics as they go through the material. The presentation is not linear in that the reader can follow their interests rather than being forced through the material in an order set by the author.

One of the most sophisticated online textbooks for introductory physics is from *Kinetic Books* (<http://www.kineticbooks.com/>). This book has questions and quizzes embedded in the text so that the reader is constantly testing whether they understood the material or not. If the quiz result is poor the book offers remedial material and re-tests. If the reader is successful they can continue on with new material. This is a very advanced approach to the concept of learning from written material. It is, unfortunately, relatively expensive and likely to remain so due to the extensive development efforts needed to build such a product. It also seems doubtful that these types of books will be available for higher level courses where enrolment is too low to support the development of such a complex resource.

What about writing your own electronic book? There are many programs in existence for creating texts with varying degrees of interactivity. Examples include eCub, Sigil, Jutoh, Calibre, KooBits, Scrivener, InKling Habitat, MegaZine3, Soomo, BookType, Atlantis, Adobe, iBook Author and more. There are also many formats to choose from for the final product: PDF, epub, Amazon, etc. In the following we describe two interactive books created by one of the authors (Forinash).

3. Wave Tutorial

In 2005, one of the authors (Forinash) started writing an online interactive textbook on waves (<http://homepages.ius.edu/kforinash/W/Waves.html>) using OpenSource Physics tools (<http://www.opensourcephysics.org/>) provided by Wolfgang Christian and Francisco Esquembre. The site was completed in 2011 and awarded the MPTL (<http://www.mptl.eu/>) award in 2013 and the MERLOT (<http://www.merlot.org/merlot/index.htm>) award in 2014. This tutorial consists of 32 separate chapters, each covering a particular aspect of waves. Each chapter starts with a simple introduction and an interactive Java applet (Figure 1).

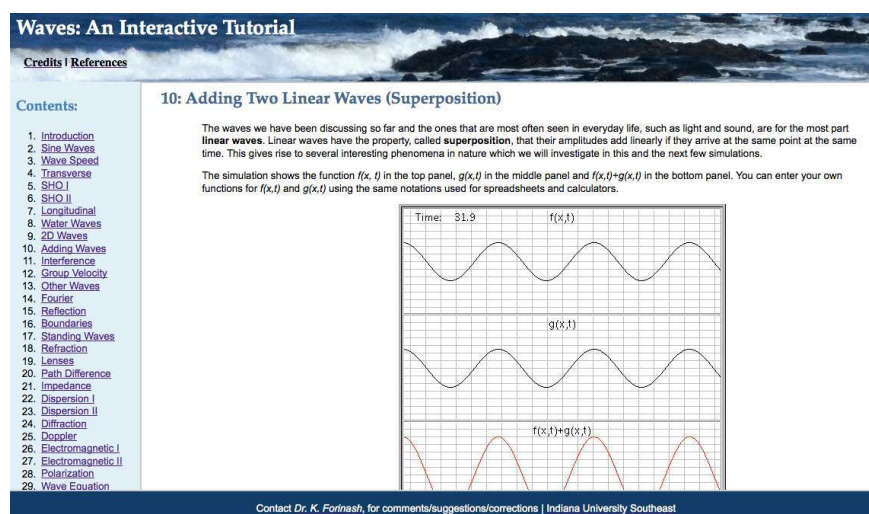

Figure 1. Top part of chapter 10; Adding Waves.

Each simulation is followed by a series of questions that ask the reader to change the parameters of the simulation to see what happens. The fact that the simulations allow the representation of a moving wave, rather than a static picture helps the student connect the mathematical description with a time dependent

visualization. For example, the simulation in chapter 10 shows the superposition of two waves as they are moving. The student can modify the shape of two waves and see what happens when they are added, point-by-point (Figure 2). In a series of guided questions, the student is asked to experiment with the simulation by changing various parameters to learn about the behaviour of waves. Questions two, three and four of chapter 10, for example, ask the student to change the phase of one of the waves to see the effect of this parameter on the combined wave. In other questions they come to an experimental understanding of standing waves, nodes, antinodes, interference and beats. The intent is for the reader to learn by experimentation rather than memorization.

Figure 2. The first few questions of chapter 10; Adding Waves.

Each of the 32 chapters is constructed in a similar fashion, each with a simulation and questions so that as the student works through the text they build an intuitive and visual connection between physical concepts and the mathematical descriptions which describe them.

We do not have a course devoted entirely to waves at our institution. However, a significant number of the chapters have been used in introductory physics courses over the past few years. Although we have not done a formal evaluation of student learning, student reaction to the simulations, both as instructional material presented in class and as homework exercises has been very favourable.

4. Sound Book

A similar approach was used for a physics of sound textbook (<https://soundphysics.ius.edu/>). In this case, not only are simulations used but also embedded YouTube videos (Figures 3 and 4) are included. The site was designed by a group of computer science students using material assembled by the instructor.

Figure 3. The top of the chapter on resonance of the Sound book.

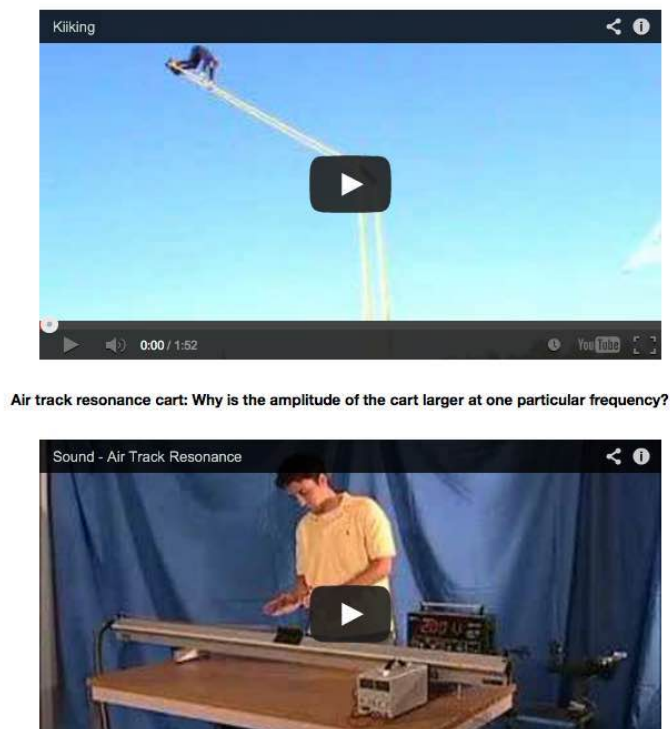

Air track resonance cart: Why is the amplitude of the cart larger at one particular frequency?

Figure 4. Examples of resonance YouTube videos embedded in the *Sound Book*. The top video is an example of a driven pendulum. The bottom video shows a spring-mass system driven above, below and at resonance.

The *Sound Book* was used in a class this past spring semester (2014) and several complications were revealed. During the course meeting time students worked on group assignments which generally require access to the text. Some students elected to bring laptops, tablets or smartphones to class in order to have the *Sound Book* with them. Java applets do not run on most tablets or phones so only the text and videos were available in class, not the simulations. Two students printed out all the web pages of the online book and brought the pages to class. The site was also projected onto a screen during these exercises but this is not the most desirable way to access the material in class. The lesson learned is that online texts are not intrinsically portable. To make them so, the simulations need run on mobile devices and students must have access to a mobile device.

During the second week of class a new version of Java was released and all of the simulations stopped working for older versions of Java. Students had to update the Java engine on their home computers and the university's IT department had to update machines on campus so that homework assignments using the applets could be completed. This delayed homework assignments by about two weeks. Though it is well known that technology constantly changes, there is no way to anticipate this possibility.

Student evaluations, including student comments for two semesters of the sound course were collected (much of the material, including some of the simulations was tested in the course the prior year, spring of 2013). Based on these evaluations and informal comments given out of class, students liked the fact that they did not have to pay for a textbook but were not completely happy with the alternative. On the evaluations 75% of the students responded favourably (strongly agree or agree) with the statement "The course assignments [which included the simulation material] helped in learning the subject." However in comments they said they thought access to the book was problematic and the difficulties with Java applets very aggravating. The simulations have now mostly been converted into JavaScript to work on tablets and will not be affected by version updates as much so we expect student acceptance of the online material to improve in the course (which is presently being taught for a third time).

5. What about labs with real data?

Simulations are a great way to allow students to manipulate various parameters of an experiment in a controlled way. They allow students to slow things down and visualize complex processes. But science ultimately is built on real data. Can technology help us provide an interactive experience with data collection?

We think mobile devices (smartphones and tablets) can serve as a vehicle to engage students in science by moving students out of the rigid two hour student laboratory to collect real data in real life situations. For example, the internal accelerometer (used to orient the screen on tablets and smartphones) can be used to measure acceleration in a number of different situations (Wisman, 2010). We have analyzed the acceleration of a commercial jet (Forinash, 2014) using an app that we wrote which records acceleration in a spreadsheet format so that it can then be emailed and analyzed on a computer. With mobile devices, students can investigate the motion of their bicycles, amusement park rides, cars, skydiving or bungee jumping. Accelerometer apps have been used in many other contexts, for example, the acceleration during collisions (Vogt, 2014) and the acceleration of free fall (Vogt, 2012).

Most mobile devices have many other sensors, for example, magnetic field sensors. In Figure 5, we show an experiment where the magnetic sensor in a tablet is used to find the dependency of field strength as a function of distance along the axis of a bar magnet. Figure 6 shows the spreadsheet data from a trial run.

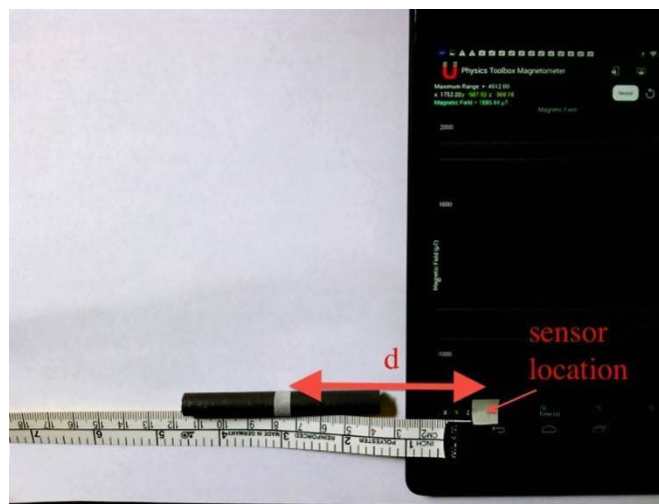

Figure 5. A tablet with a magnetic sensor used to measure the magnetic field of a bar magnet at different distances.

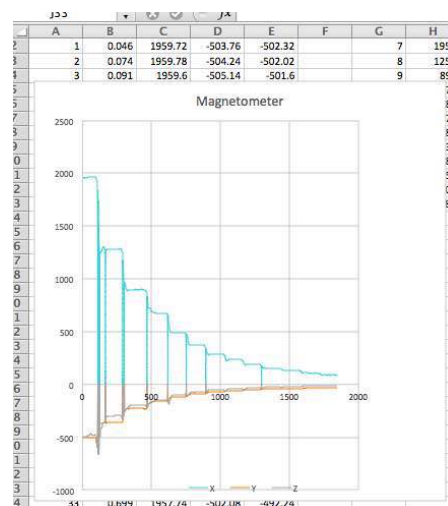

Figure 6. Data from the setup shown in figure 5. The magnet was gradually moved by 1 cm and held in place for 4 s out to a distance of 15 cm while the tablet recorded the field strength.

Using a mobile device for data collection often requires creative use of the technology. For instance, sound can be used for timing experiments if the beginning and ending of the experiment produce a sound. In Figure 7, a screenshot of the sound amplitude graph of a bouncing ball is shown. There are three bounces and the app allows a very precise measurement of the time between bounces which can be used to measure the coefficient of restitution of the ball. Similarly, the sound of a pair of scissors cutting a string holding an object and the sound of the object striking the floor can be used to determine the time of a falling object (Forinash, 2014) and to verify the gravitational constant.

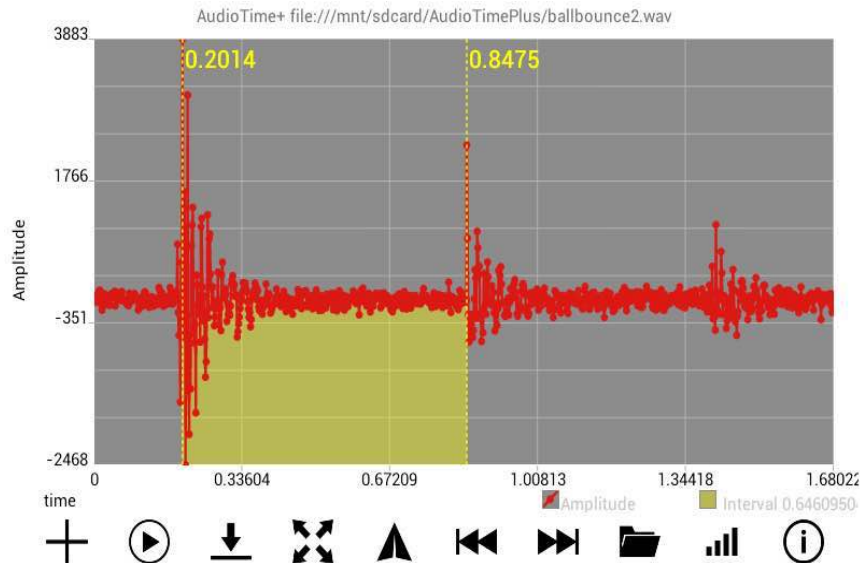

Figure 7. The sound of a ball bouncing three times as recorded by our sound app. A very accurate measurement of the time between bounces can be made from the recorded sound.

A mobile device can take additional data measurements with a simple external circuit containing other types of sensors. We have previously described a circuit containing a thermistor that can be used to measure local temperatures (Forinash, 2012a). In Figure 8, a similar circuit with two photo resistors is being used in a photo-gate timing measurement. As the Plexiglas with two tape stripes falls it blocks the photo resistors and the decrease in signal is recorded on the mobile device (a tablet in this case). Other measurements are possible with the same circuit using any sensor that acts as a variable resistor.

There are many other potential and existing uses of mobile devices as data collection devices. The camera can be used to measure spectra, an external probe can turn the device into a simple oscilloscope, the microphone can be used with an app to do a Fast Fourier Transform (Forinash, 2012b and Forinash, 2013). The speed of an object can be measured using the Doppler sound frequency shift (Forinash, 2014).

We have not done a formal evaluation of student reaction to using cell phones to collect data. However we have given an invited workshop to 50 high school physics teachers in Argentina at the International Conference on Physics Education (ICPE) 2014, Cordoba, Argentina, August 18-21. The reaction among the teachers was very enthusiastic; many participants left with ideas and plans for incorporating cell phone data collection in their classrooms. We think this indicates the utility of applying these ideas in the classroom, particularly in localities where lab equipment may be scarce. Our collection of ideas, articles, list of mobile device apps and laboratory exercises in English and Spanish can be found at <http://mobilescience.wikispaces.com/>.

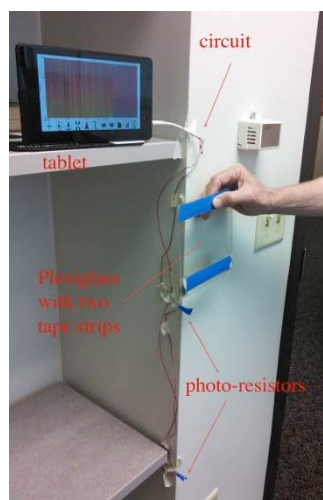

Figure 8. A tablet connected to an external circuit containing two photo resistors is being used to measure the acceleration of a falling piece of Plexiglas.

6. Conclusion

Science education has yet to fully appreciate or master the new communication technologies. It is always difficult to predict where technology will lead but we think electronic books will become much more interactive with simulations, video and quizzes for self testing. Books of the future will require an active participation with the knowledge presented rather than a passive reading. We also think mobile devices, such as tablets and smartphones, will become important tools for moving students out of the classroom and into the real world to take real data about the things they find interesting.

References

- Forinash, K and Wisman, R. (2012a) Smartphones- Experiments with an External Thermistor Circuit, *The Physics Teacher*, Vol. 50 No. 9 p566.
- Forinash, K and Wisman, R. (2012b) Smartphones as portable oscilloscopes for physics labs, *The Physics Teacher*, Vol. 50 No. 4 p242.
- Forinash, K and Wisman, R. (2013) Smartphones as Data Collection Tools for Science Education, *International Newsletter on Physics Education*, Vol. 64. Published jointly by the International Commission of Education and the International Union of Pure and Applied Physics.
- Forinash, K and Wisman, R. (2014) Using Sound to Measure Speed with a Smartphone, submitted to *The Physics Teacher*.
- Vogt, P. and Kuhn, J. (2012) Analyzing free fall with a smart phone acceleration sensor, *The Physics Teacher* 50, 182-183.
- Vogt, P. and Kuhn, J. (2014) Analyzing collision processes with the smartphone acceleration sensor, *The Physics Teacher* 52, 118.
- Wisman, R. and Forinash, K (2010) Mobile Science, *Ubiquitous Learning: An International Journal*, Vol. 3 No. 1.

Affiliation and address information

Kyle Forinash and Raymond Wisman
School of Natural Sciences
Indiana University Southeast
New Albany IN, 47150, USA
e-mail: kforinas@ius.edu ; : rwisman@ius.edu

Use your Head – in Football and in Physics Education

Angela Fösel^{1*}, Leopold Mathelitsch², Sigrid Thaller³, Jens Wagner¹

¹*Didaktik der Physik, Friedrich-Alexander-Universität Erlangen-Nürnberg, Staudtstraße 7, 91058 Erlangen, Germany*

²*Institut für Physik, Universität Graz, Universitätsplatz 5, 8010 Graz, Austria*

³*Institut für Sportwissenschaft, Universität Graz, Mozartgasse 14/I, 8010 Graz, Austria*

**corresponding author, Email: angela.foesel@physik.uni-erlangen.de*

Abstract

In this paper, we will show that headers may enrich physics education. Thereby, students participating in lab work are addressed most. We first give a literature survey of football-themed discussions. We then present and illustrate arguments for the educational relevance of discussing headers in physics education. Concerning our experiment 'heading a football', we especially would like to focus on and present the examination of the interaction of football and head from various different viewpoints: On the one hand, we introduce a wide array of experimental approaches, from simple experiments to video analysis and data acquisition with acceleration sensors. We show the consistency of data from the video-camera with those from sensor-based data logging. We attempt to explain the data by using theoretical models of varying complexity. Finally, health aspects with regards to headers are discussed.

Keywords

Modelling; video analysis; data acquisition with acceleration sensors; sports in the context of physics.

1. Introduction

Football is one of the most popular sports in many countries, which means that a football-themed physics discussion usually arouses great interest. This presumably accounts for the fact that a wide range of (popular) science literature, as well as technical and subject-didactic articles have been published on this subject. Apart from extensive works on football in its entirety (Tolan 2011, Tolan 2010, Wesson 2002), some partial aspects have been singled out for closer scrutiny, such as unexpected trajectories of balls (curling crosses), which impressively show the Magnus effect (Mathelitsch et al. 2006, Zimmermann 2012), the high ratio of coincidence in football results, which lends itself to statistical evaluation (Heuer 2012), and the goalie's (and the penalty-taker's) anxiety at the penalty kick, which can be convincingly explained with kinematics (Mathelitsch et al. 2008, Labudde 1989). Another important component of the game, namely *headers*, have not yet been analysed as diligently, even though the question of how dangerous a header really is relates directly to the determination of the forces and acceleration involved. Recently, we have analysed headers in football in the context of physics and physics education (Fösel et al. 2014).

2. Educational relevance

We think that there are quite a few arguments for including football-themed discussions, especially 'heading in football', in physics education. Subsequently, we will present and illustrate some of them.

The 'Kieler Interessensstudie Physik', a German interest study, carried out from 1984 to 1989 by the Leibniz Institute of Science Education (IPN), has shown the decline of students' interest in physics during secondary education, particularly among girls (Hoffmann et al. 1998). To understand the science- and technology-related interests, priorities and attitudes of the young generation, the international comparative study 'Relevance of Science Education' ROSE investigated the diversity of interests, experiences, priorities, hopes and attitudes that children in different countries bring to school or have developed at school. As a result, today's young people are strongly interested in contexts linked to health and fitness (Elster 2007a, Elster 2007b, Holstermann et al. 2007, Jenkins et al. 2006, Schreiner et al. 2004, Schreiner 2006). So, including sports issues in physics education offers an opportunity to increase students' interest and motivation.

Furthermore, it allows for taking into account the methodical and didactic ideas of 'active learning' (Shepard 1997, Diamond 2000), which here means that students can 'design' the experiments in a self-contained way and that they have the freedom of an active planning, respectively. Especially when analysing headers, students have to design an experiment for modelling the real situation 'heading a football', and they are asked to do the modelling in their own way. This also includes – for example - developing ideas where and how to fix acceleration sensors or how to synchronise data from different systems.

Scientific methods, 'observing', 'measuring', 'testing hypotheses', 'modelling', 'experimenting' and 'interpreting', help with learning concepts and principles of science (learning OF science). Getting to know scientific methods helps understanding the nature of science (learning ABOUT science) and scientific methods are a way towards 'goals' not specific for just one subject, e.g. learning how to solve problems or acquiring critical faculties (DOING science). While analysing headers, students apply different scientific methods and therefore learn OF science, they also learn ABOUT science and – most important – they DO science. A wide range of literature about the subjects 'scientific methods and science education' and 'nature of science' have been published. Wynne Harlen, for example, discusses scientific methods in the context of teaching, learning and assessing science (Harlen 2006). McComas (McComas et al. 1998), Höttecke (Höttecke 2001) and Neumann (Neumann 2011) introduce in the nature of science.

Students make (computer-based) measurements, they use high-speed camera systems and also acceleration sensors for capturing position and acceleration. At this point, it should be stressed that high-speed video analysis can be an important tool to study the dynamics of transient phenomena qualitatively as well as quantitatively, and that there is obviously a large number of exciting opportunities to explore science in the classroom or in lab work. This is why the application of high speed imaging (Vollmer et al. 2011b) and the technology of modern high-speed cameras (Vollmer et al. 2011a) have been treated widely in the literature.

Students understand the necessity of synchronising data from the video-camera with those from sensor-based data logging, and they investigate possibilities to do so. They get to know different ways to put the data into graphs, and they have to analyse the data: For example, by integrating the acceleration data twice using simple numerical integration methods, one achieves displacement. That way, the students can integrate 'by hand', which means there is a strong interdisciplinary aspect relating to mathematics; they can also 'just use' the feature 'analysis/integrating' of a standard computer-aided system as a 'black-box' and get to know the power of computer-aided systems. However, the role of mathematics should not be reduced to technical aspects. Deeply exploring the interdependency, for example by doing graphical representations of e.g. experimental data, improves the understanding of physics and the understanding of the nature of science (Uhden et al. 2012).

Students do face problems though when working with the data from video analysis. The plain difference quotient leads to rather inexact velocity values, and students are forced to learn how to solve these problems. Interpreting the position-time-diagrams as well as the velocity-time-diagrams and the acceleration-time diagrams is a challenging task: For example, it is very difficult to find an explanation for a 'double-peaked' acceleration-curve of the temple, as we will show later on; it was only after modelling that an acceptable interpretation was possible.

However, despite the difficulties, students are encouraged to discuss and communicate, therefore gaining communication skills and competencies (Kulgemeyer et al. 2013, Kulgemeyer et al. 2014). Modelling, together with experimenting, takes centre stage when it comes to knowledge acquisition, and curricula demand that students continuously and systematically learn how to make useful models: This includes grasping the idea of a model and the ability to use models meaningfully. The discussion of physical aspects of sports activities makes the necessity of models very obvious, as due to the complexity of the human body only model approximations can be meaningfully applied. Therefore, simple models make it possible to estimate certain parameters like maximum forces; dynamic models can also simulate the chronological process of an action. Students discuss about different models and thereby acquire critical faculties. By the way, 'modelling' was the main subject of the GIREP conference 2006 in Amsterdam (van den Berg et al. 2007).

Discussing headers in physics education finally encourages students to reflect on the 'social relevance' of the results: The question of how dangerous a header really is relates directly to the determination of the forces and acceleration involved, and having numerical values helps in critically balancing the pros and cons of introducing the obligatory wearing of a helmet by younger children when heading a football.

3. Experiments

In the context of physics, we consider the interaction of football and head as a collision process of football and head. The collision of a ball always involves some loss of energy, and the energy loss can be expressed in terms of the coefficient of restitution, e , defined in the case of a rigid surface by $e = v_2/v_1$, where v_1 is the incident speed of the ball and v_2 its rebound speed.

Because data logging and analysis concerning real situations within a football match are a lot more difficult than experimental set-ups in the laboratory, we 'designed' an experiment, modelling the real situation 'heading a football': We asked a 'header player' to stand without moving his head. This means we may assume that the speed of his head (approximately) equals zero. Another person throws a football in quite a straight line and centrally in the direction of the 'header player'. We observed this 'experiment' by video-camera. We experimentally determined the values of the incident speed of the football before the collision of the ball with the head ($v_1 = 4.7$ m/s) and of the rebound speed of the ball after the collision of the football with the head ($v_2 = 3.5$ m/s) using the data from video analysis. The ratio of the rebound speed of the football and the incident speed of the ball was calculated; the result equals 0.74. For comparison: For a football on a hard ground e is typically 0.8 (see Wesson 2002, p. 11), the speed being reduced by 20%.

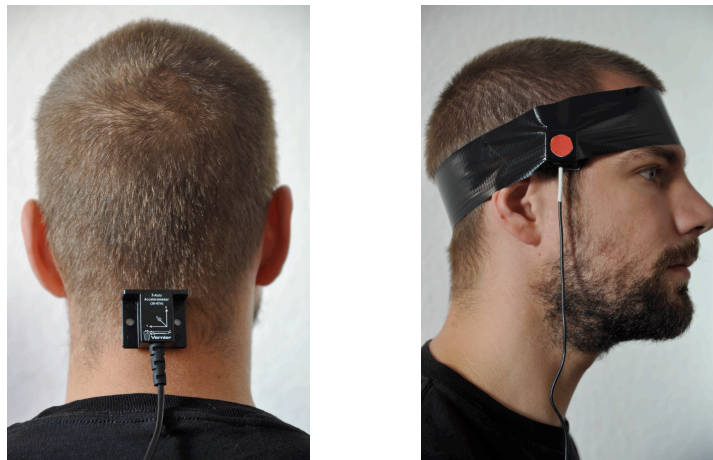

Figure 1. Mounting of the acceleration sensors

Strongly interested in the determination of the forces and acceleration inherent to or resulting from headers, from here on, we did the data logging with two different systems, working independently of each other: One system we used was a *high-speed camera system of the type 'Motion Traveller 300'*, developed and distributed by the (German) company 'Imaging Solutions' (datasheet see Imaging Solutions GmbH, 72800 Eningen. www.imaging-solutions.de): We simultaneously filmed the movements of the header player and of the football with 300 fps at 640 by 480 pixel resolution.

The other system we used were *acceleration sensors*, developed by the American company 'Vernier' and distributed by the company Naturwissenschaftliche-Technische-Lehrmittel NTL (Fruhmann GmbH NTL Manufacturer & Wholesaler, A-7343 Neutal/Austria. www.ntl.at), for measuring the acceleration of the head: More precisely, we used the sensors for capturing the acceleration of the temple and also of the neck of the header player. In doing so, for the determination of the horizontal acceleration of the temple, we used a 25 g-accelerometer (P4210-1B). For measuring the horizontal acceleration of the neck, we used a 5 g-accelerometer (P4210-3B). The 5 g-accelerometer is a 3-axis accelerometer, which has three separate internal accelerometers mounted orthogonally. Though we were primarily interested in the horizontal acceleration of the neck, we also registered and read out the vertical component: A vertical jump at the beginning of the experiment was recognised by the internal vertical accelerometer *and* by the high-speed camera system, which means that the two systems, i.e. the acceleration sensor(s) system and the high-speed camera system, are synchronised. - Capturing data and data read-out via data logger ULAB (datasheet for data logger ULAB P4910-1U see Fruhmann GmbH NTL Manufacturer & Wholesaler, A-7343 Neutal/Austria. www.ntl.at) took place at 2000 Hz.

Figure 1 shows the mounting of the sensors at the head of the player. In the left picture, we left off the outside black tape to make the sensor visible. The right picture shows the final mounting at the temple *with* black tape and with a (red) marker, which is necessary for analysing the video. After final mounting, exactly the same kind of tape and marker was added to the acceleration sensor at the neck as well.

Using the data logging software COACH 6 (manual for data logging software see Fruhmann GmbH NTL Manufacturer & Wholesaler, A-7343 Neutal/Austria. www.ntl.at) for evaluating the video, the video was analysed regarding the time-dependent course of the position that the head covers over a distance in horizontal direction. Thereby, it made sense to use the afore-mentioned marker at the temple sensor for reliable tracking results. 0.83 mm in real life correspond to the width of one pixel of the camera, horizontally as well as vertically. The registration of the movement of the marker by hand or automatically lead to the same result within an accuracy of ± 2 pixel (resp. 1.7 mm in the position in horizontal direction). In fig. 2a one can see the horizontal movement of the head (the temple). The first contact between head and football was timed at $t_1 = 4.027$ s, the last contact at $t_3 = 4.047$ s. The maximum deformation was timed at $t_2 = 4.040$ s (see fig. 2c). The inaccuracy due to the video's frame rate may be assumed at one frame maximum, regarding timed assignment.

The original direction of the ball was considered as positive direction of movement. Thus, the rising of the curve shows that the person (header player) moves the head after contact with the ball in a forward direction (despite having been asked to keep his head still without any movement). This may be convincingly explained by anticipation and tension of the muscles. The movement forwards ends right before the maximum deformation of the ball.

The data from both acceleration sensors are shown in fig. 2b. Because of the high accuracy of the sensors ($\pm 2.5 \text{ m/s}^2$ for the 25 g- and $\pm 0.5 \text{ m/s}^2$ for the 5 g-sensor) in fig. 2b, error bars are not plotted. At the first contact with the ball, one cannot see any acceleration of temple and neck. The acceleration-curve of the temple is 'double-peaked', and even during ball contact there is a negative acceleration (deceleration) of the head. The acceleration of the neck is far less and starts later. The largest values for acceleration of temple and neck occur at the moment of maximum deformation of the ball. We shall discuss this 'double peak' in more detail with a suitable modelling later on.

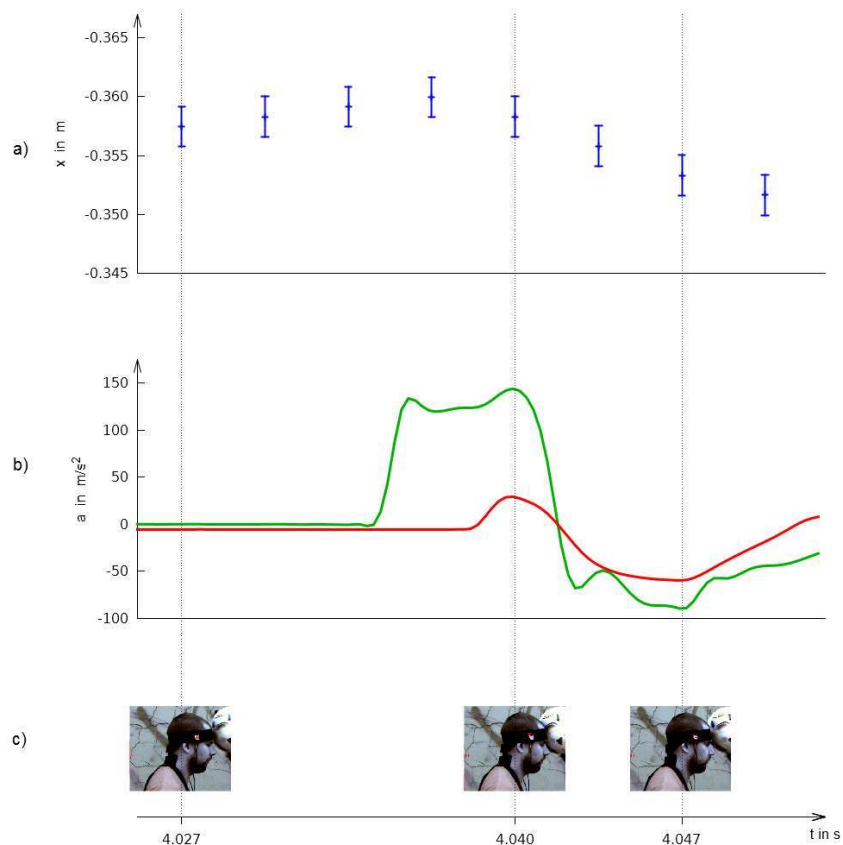

Figure 2. Collision of a football and a head, the head being almost at rest: a) Result of video analysis regarding horizontal movement, b) Data read-out from acceleration sensors (green: temple, red: neck), c) Timed assignment of the first and the last contact of football and head, and of the maximum deformation of the ball

The synchronisation – remember the 'vertical jump' - of both data, i.e. the data from the acceleration sensor(s) and the data from the high-speed camera system, allows for the comparison of equivalent diagrams.

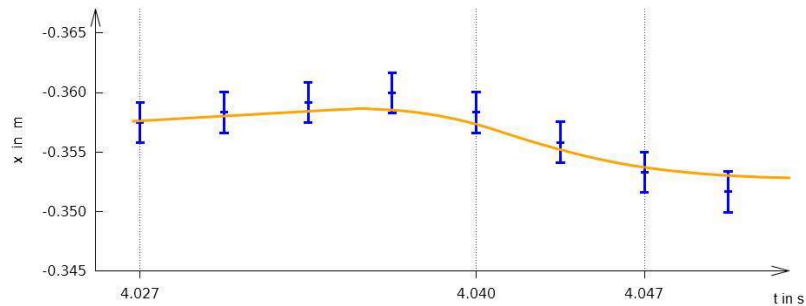

Figure 3. Comparison of position-time-diagrams. Analysis of video (blue dots, with error bars), calculation from acceleration sensor data (orange curve)

We integrated the acceleration data using simple numerical integration methods, and by doing so twice, we achieved displacement.

Fig. 3 shows the comparison of the calculated values with the corresponding data we gathered from video analysis: The curve from the video data shows clearly that the test person moved his head forwards after contact with the ball, and the calculated values confirm this observation: The calculated values for the position coordinates increase initially. The forwards movement may well be perceived as more extreme here than it actually was. Both curves show consistently that the player's head only starts moving backwards immediately before the maximum deformation of the ball ($t = 4.040$ s): The position coordinates decrease in number from $t = 4.037$ s. The curve from the calculated data shows a positive curvature from $t = 4.037$ s to $t = 4.042$ s, meaning that the head's backward move occurs at an increased speed. Afterwards, the test person's head moves further backwards: The position coordinates decrease in quantity even beyond the point in time when the ball leaves the head ($t = 4.047$ s). The curve shows a negative curvature from the calculated values then, though: This is an indication that the backwards movement is slowed down in this time interval. The interpretation of the position curve regarding the curvature properties corresponds to the data of the acceleration sensor (fig. 2b): In the interval from $t = 4.037$ s to approximately $t = 4.042$ s, the acceleration of the head is positive. After a zero crossing of the curve there is a significant negative acceleration until $t = 4.050$ s.

Working with the data from video analysis is a lot less precise than with those from the acceleration sensor, as the frame rate and the imprecision of the data are central to the calculation. The plain difference quotient leads to rather inexact velocity values. Therefore, we have accumulated mean values, which are effectively floating around three measured values. Fig. 4 shows the seven mean values (purple) together with the velocity curve (turquoise), found by numerical calculation from the acceleration sensor's values.

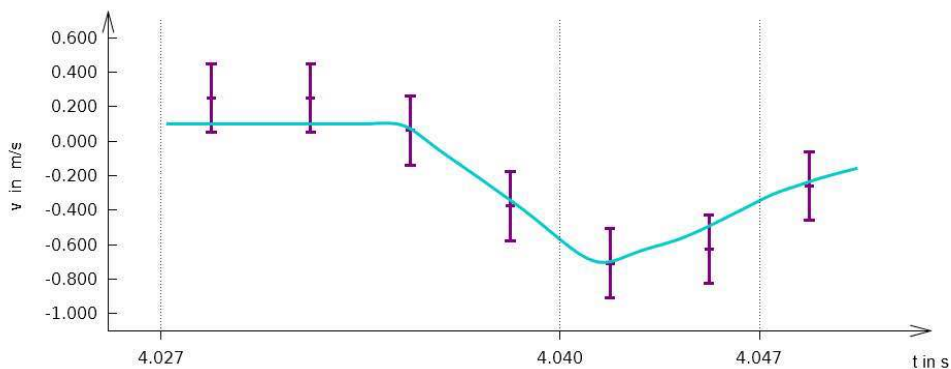

Figure 4. Comparison of velocity-time-diagrams. Purple dots, with error bars: calculated data from video. Turquoise curve: calculation from acceleration data of sensor

After the initial contact, the velocity is slightly positive, while the test person's head moves forward. From approximately $t = 4.037$ s (zero crossing of the velocity curve), the head moves at an increasing (according to

the values) velocity backwards. The velocity reaches a maximum at approximately $t = 4.042$ s (acceleration zero), returning (slowing down) to decreased values afterwards.

4. Modelling

The *most basic model* of a header is that a completely elastic collision occurs in the interval T , and that the momentum of the ball with the mass m is changed into an impulse to the head. If we take the values $m = 0.44$ kg, $v_1 = 4.7$ m/s, $v_2 = 3.5$ m/s, $T = 0.02$ s, we get a value of $F = 180$ N. This is, however, a mean value over the complete period of time T . In order to determine the maximum force, we need *another model*, in this case one which shows the change in force over time. If we assume that the force increases linearly over a time from $T/2$ to a maximum value of F_{max} , and then linearly decreases again during the time $T/2$, we shall get a maximum force of $F_{max} = 2 F$, and for our example $F_{max} = 360$ N. From the data, we do however see that the impulse is a lot shorter; it more or less coincides with the range of the green curve in fig. 2b. A contact time of $T = 0.008$ s results in a maximum force of $F_{max} = 450$ N.

If we wanted to draw conclusions about the acceleration of the head from the force $F = m_1 \cdot a$, we would get an acceleration of $a = 113$ m/s² = 12 g, using $m_1 = 4$ kg for the mass of the head. As it happens, the head is more or less inflexibly connected to the upper body, so there is actually a greater effective mass and a reduced acceleration. We have analysed the relative impact of these masses in a simulation.

The biomechanic P. E. Riches has shown (Riches 2006) the impact of the neck muscles as a connection with a fixed body by using a spring with a definite spring constant and also a damper part to influence the movement. We have enhanced this model so that we can scrutinize the dynamic of three masses, which are flexible towards each other: The first mass m_1 acts as the fixed part of the head, here the acceleration sensor is fixed and here the ball hits the head. The second mass m_2 is elastically coupled to m_1 by a spring and shows how the flexible parts within (e.g. semi-fluid matter) and outside the head (e.g. cheeks) react. The third mass m_3 represents the rest of the body, and it is also coupled to m_1 by a spring. The force $F(t)$ of the ball during the contact period T is shown by a half sine wave in the enhanced model as in Riches' model (Riches 2006): $F(t) = \sin(\pi t/T)$. If we apply Newton's equation of motion for each of the three masses, we get three coupled differential equations, which can also be approximately solved, step by step, for example by a spreadsheet. With these simple model assumptions, the measured data can be simulated in a qualitative way: In the measured curve of the temple sensor, there are two acceleration peaks in the elastically coupled part m_2 . How pronounced this 'double-peakedness' is depends on the impulse, the ratio of the masses m_1 and m_2 and their coupling, but also on the coupling to the body m_3 . Fig. 5 shows a simulation with $F_{max} = 500$ N and different mass ratios m_1/m_2 . We assumed $T = 0.01$ s as contact time, as only during this period the sensor gathered noteworthy positive values. The higher the fixed mass ratio in the head, the less pronounced the double-peakedness of the acceleration curve.

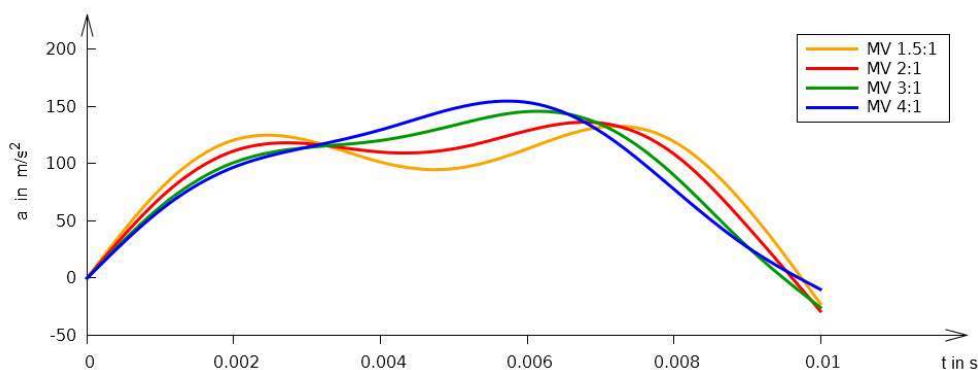

Figure 5. Impact of the ratio of fixed mass m_1 and flexible mass m_2 within the head on the acceleration of the fixed mass, supposing $F_{max} = 500$ N and contact-time is 0.01 s (simulation)

As initially mainly the fixed part m_1 of the head is accelerated, the beginning acceleration curve is rather flatter with a higher mass ratio of m_1 . In another simulation, we surveyed the impact of the tension of the neck muscles on the acceleration of the fixed part m_1 in the head: The more inflexible the connection between head and body, the less pronounced the double-peakedness of the acceleration curve of the head m_1 .

5. Outlook

We have shown that *experimenting with and modelling headers are a plus for physics education*: We presented and illustrated arguments for its educational relevance. The level can be from high school to university physics.

In detail, we described an experiment 'heading a football': We showed that data could be acquired by video analysis and acceleration sensors. Integration and differentiation of such datasets have proven to correlate well. Data recording and evaluation are of course more difficult in a real match situation than they are in the laboratory.

Simple models make it possible to estimate certain parameters like maximum forces; dynamic models can also simulate the chronological process of an action.

The question whether or not the collision of a ball and a head can result in damage to the latter must first lead to an evaluation of the prerequisites of our model experiment 'idealised header situation' as opposed to a real header situation: In our experiment, the ball was thrown by hand, which means the velocity was rather low. The resulting forces and accelerations occurring within the given time frame are almost certainly not harmful to the test person's head. In a match situation, however, the ball may reach speeds of up to 100 km/h and more.

Still, the answer to the question whether or not headers are a health risk depends on a variety of factors. Teachers can encourage discussing these risks by talking about suitable publications, e.g. Zhang 2013 or Witol et al. 2003.

References

- Brands, D. W. A., Thunnissen, J. G. M. and Wismans, J. S. H. M. (1997). Modelling Head Injury Countermeasures: a 3D helmet model, *AGARD-CP-597*, 261 - 268.
- Diamond, A. (2000). Close Interrelation of Motor Development and Cognitive Development and of the Cerebellum and Prefrontal Cortex, *Journal of Child Development*, **71** (1), 44 – 56.
- Elster, D. (2007a). Interessante und weniger interessante Kontexte für das Lernen von Naturwissenschaften, *Der mathematische und naturwissenschaftliche Unterricht* **60** (4), 243–249.
- Elster, D. (2007b). Contexts of Interest in the View of Students – Initial Results of the German and Austrian ROSE-Survey, *Journal of Biological Education*. UK. **42** (1), 1-9.
- Fösel, A., Mathelitsch, L., Thaller, S. and Wagner, J. (2014). Mit Kopf – im Fußball und im Physikunterricht, *PdN Physik in der Schule* **1/63**, 17-22.
- Fruhmann GmbH NTL Manufacturer & Wholesaler, A-7343 Neutal/Austria. www.ntl.at (17.03.2015)
- Harlen, W. (2006). *Teaching, Learning and Assessing Science 5-12*, SAGE Publications Ltd, London.
- Heuer, A. (2012). *Der perfekte Tipp – Statistik des Fußballspiels*, Wiley-VCH Verlag, Weinheim, Germany.
- Hoffmann, L., Häußler, P. and Lehrke, M. (1998). *Die IPN-Interessensstudie Physik*, Kiel: IPN.
- Holstermann, N. and Bögeholz, S. (2007). Interesse von Jungen und Mädchen an naturwissenschaftlichen Themen am Ende der Sekundarstufe I, *Zeitschrift für Didaktik der Naturwissenschaften* **13**, 71-86.
- Höttecke, D. (2001). *Die Natur der Naturwissenschaften historisch verstehen: Fachdidaktische und wissenschaftshistorische Untersuchungen*, Logos Verlag, Berlin.
- Imaging Solutions GmbH, 72800 Eningen. www.imaging-solutions.de (17.03.2015)
- Jenkins, E.W. and Pell, R. G. (2006). *The Relevance of Science Education project (ROSE) in England: A summery of findings*, Leeds: University of Leeds, Centre for Studies in Science and Mathematics Education.
- Kulgemeyer, C. and Schecker, H. (2013). Students explaining science – assessment of science communication competence. *Research in Science Education* **43**, 2235 – 2256.
- Kulgemeyer, C. and Schecker, H. (2014). Research on Educational Standards in German Science Education – Towards a Model of Student's Competences. *Eurasia Journal of Mathematics, Science and Technology Education*, **10** (4), 257 – 269.

- Labudde, P. (1989). *Alltagsphysik in Schülerversuchen. P. 15-16: Die Angst des Tormanns beim Elfmeter*, Dümmler Verlag, Bonn, Germany.
- Mathelitsch, L. and Thaller, S. (2006). Fußball mit Wissenschaftlichem Maß: Bananenflanken, Flatterbälle und Kopfbalkämpfe, *Physik in unserer Zeit* **37** (3), 122 - 125.
- Mathelitsch, L. and Thaller, S. (2008). *Sport und Physik. Praxis Schriftenreihe 64*, Aulis Verlag, München, Germany.
- McComas, W. F., Clough, M. P. and Almazroa, H. (1998). *The role and character of the nature of science. In: The Nature of Science in Science Education – Rationales and Strategies*, Kluwer Academic Publishers, Dordrecht.
- Neumann, I. (2011). *Beyond Physics Content Knowledge. Modeling Competence Regarding Nature of Scientific Inquiry and Nature of Scientific Knowledge*, Logos Verlag, Berlin.
- Riches, P. E. (2006). A dynamic model of the head acceleration associated with heading a soccer ball, *Sports Engineering* **9**, 39-47.
- Schreiner, C. and Sjøberg, S. (2004). Sowing the seeds of ROSE. Background, Rationale, Questionnaire Development and Data Collection for ROSE (The Relevance of Science Education) – a comparative study of students' views of science and science education (4/2004). Oslo: Institutt for læterutdanning og skoleutvikling, Universitetet i Oslo. <http://www.uv.uio.no/ils/forskning/publikasjoner/acta/acta-oslo/AD0404.pdf> (17.03.2015)
- Schreiner, C. (2006). *Exploring a ROSE-garden: Norwegian youth's orientations towards science – seen as signs of late modern identities*, Doctoral thesis, University of Oslo, Faculty of Education, Department of Teacher Education and School Development, Oslo. <http://www.uv.uio.no/ils/forskning/prosjekter/rose/publikasjoner/exploring.pdf> (17.03.2015)
- Shepard R. (1997). Curricular Physical Activity and Academic Performance. *Pediatric Exercise Science* **9**, 113 – 126.
- Tolan, M. (2010). *So werden wir Weltmeister – Die Physik des Fußballspiels*, Piper Verlag, München, Zürich, Germany.
- Tolan, M. (2011). *Manchmal gewinnt der Bessere – Die Physik des Fußballspiels*, Piper Verlag, München, Zürich, Germany.
- Uhden, O., Karam, R., Pospiech, G. and Petrocola, M. (2012). Modelling Mathematical Reasoning in Physics Education, *Science & Education* **20**(4), 485 - 506.
- Van den Berg, E., Ellermeijer, T., Slooten, O. (2007). Modelling in Physics and Physics Education. Proceedings GIREP Conference 2006. Alphabase, Alphen aan den Rijn, Netherlands.
- Vollmer, M. and Möllmann, K.-P. (2011a). High speed and slow motion: the technology of modern high speed cameras, *Physics Education* **46** (2), 191 - 202.
- Vollmer, M. and Möllmann, K.-P. (2011b). Exploding balloons, deformed balls, strange reflections and breaking rods: slow motion analysis of selected hands-on experiments, *Physics Education* **46** (4), 472 - 485.
- Wesson, J. (2002). *The Science of Soccer*, Taylor & Francis Group, New York, United States of America.
- Witol, A. D., Webbe, F. M. (2003). Soccer heading frequency predicts neuropsychological deficits, *Archives of Clinical Neuropsychology* **18** (4), 397-417.
- Zhang, M. R. et al. (2013). Evidence of Cognitive Dysfunction after Soccer Playing with Ball Heading Using a Novel Tablet-Based Approach, *PloS ONE* **8**(2), e57364.
- Zimmermann, F. (2012). Physik und Fußball – Schulversuche. Hausarbeit Univ. Würzburg. www.thomas-wilhelm.net/arbeiten/Fussball.pdf (17.03.2015)

Affiliation and address information

Angela Fösel
Didaktik der Physik
Friedrich-Alexander-Universität Erlangen-Nürnberg

Staudtstraße 7
91058 Erlangen, Germany
e-mail: angela.foesel@physik.uni-erlangen.de

Formation of Key Competencies Through Information and Communication Technology

Tomasz Greczyło, Ewa Dębowska

Institute of Experimental Physics, University of Wrocław, pl. Maksa Borna 9, 50-204 Wrocław, Poland

Abstract

The Information and Communication Technology (ICT) plays an important role, both as a tool and as an engine of changes in education. A great impact is especially visible in educational processes in physics teaching and learning. Moreover it is accompanied by actions leading to the formation of Key Competencies (KC). Different kinds of activities undertaken by Multimedia in Physics Teaching and Learning group are in line with the efforts to support the formation of all eight Key Competencies. The main aim of the paper is to introduce the Key Competencies Model (KCM) which portrays the essential knowledge, skills and attitudes related to each of the KC, together with certain examples of the use of ICT tools and procedures. The model highlights the important role of ICT in formation of the Key Competencies. Special attention is devoted to emphasizing that such tools and activities are particularly necessary for personal fulfilment and development, social inclusion, active citizenship and employability.

Keywords

Key Competencies, Information and Communication Technology, Teaching and Learning Physics

1. Introduction

In the rapidly evolving world the Information and Communication Technology (ICT) is playing an important role, both as a tool and as an engine of changes in education [Zacharia 2010], [Reynolds 2013]. Such a great impact is especially visible in educational processes in physics teaching and learning. Moreover it is accompanied by actions leading to the formation of Key Competencies, understood as a combination of knowledge, skills and attitudes appropriate to the context [Reynolds 2010], [EUR-Lex 2006].

Different kinds of activities and initiatives undertaken inter alia by international Multimedia in Physics Teaching and Learning group [MPTL 2014] are in line with efforts to support development of eight Key Competencies: communication in the mother tongue, communication in foreign languages, mathematical competence and basic competencies in science and technology, digital competence, learning to learn, social and civic competencies, sense of initiative and entrepreneurship, cultural awareness and expression [EUR-Lex 2006].

It is therefore fruitful to portray the essential knowledge, skills and attitudes related to each of the Key Competencies in a framework of modelling the competence in the educational process of a student [Czapla 2013]. This should be done in carefully chosen framework of integrated model of competencies [White 1959]. Different aspects of learning processes such as: ethics, emotional intelligence, attitude, socialization, knowledge, understanding, etc. need to be presented as complementary elements of the model. The model could be enriched with certain examples of the use of ICT tools and procedures namely web services, educational environments and electronic resources. In authors' opinion these tools and procedures play an important role in formation of the Key Competencies in the nowadays educational institutions and their environments. They also moderate the way in which student acquires KC.

2. Key Competencies

Key Competencies in the shape of knowledge, skills and attitudes appropriate to each context are fundamental for each individual in a society especially when broad use of ICT technology is observed. KC serve as a reference tool for European Union (EU) countries to ensure full integration into their strategies and infrastructures, particularly in the context of lifelong learning. As KC cover wide range of human activity they might guarantee more flexibility in the labour market, supporting adaption to constant changes in an

increasingly interconnected world. They are also recognized as a major factor in innovation and motivation of workers as well as in improving a quality of work [EUR-Lex 2006].

There are eight Key Competencies defined:

- communication in the mother tongue (CMT¹) - the ability to express and interpret concepts, thoughts, feelings, facts and opinions in both oral and written form (listening, speaking, reading and writing) and to interact linguistically in an appropriate and creative way in a full range of societal and cultural contexts;
- communication in foreign languages (CMF) - involves, in addition to the main skill dimensions of communication in the mother tongue, mediation and intercultural understanding;
- mathematical competence and basic competencies in science and technology (MCST) - mathematical competence is the ability to develop and apply mathematical thinking in order to solve a range of problems in everyday situations, with the emphasis being placed on process, activity and knowledge; basic competencies in science and technology refer to the mastery, use and application of knowledge and methodologies that explain the natural world;
- digital competence (DC) - involves the confident and critical use of information society technology (IST) and thus basic skills in information and communication technology (ICT);
- learning to learn (LL) - related to learning the ability to pursue and organise one's own learning, either individually or in groups, in accordance with one's own needs, and awareness of methods and opportunities;
- social and civic competencies (SCC) - social competence refers to personal, interpersonal and intercultural competence and all forms of behaviour that equip individuals to participate in an effective and constructive way in social and working life; civic competence, and particularly knowledge of social and political concepts and structures (democracy, justice, equality, citizenship and civil rights), equips individuals to engage in active and democratic participation;
- sense of initiative and entrepreneurship (SIE) - the ability to turn ideas into action, it is the foundation for acquiring more specific skills and knowledge needed by those establishing or contributing to social or commercial activity;
- cultural awareness and expression (CAE) - involves appreciation of the importance of the creative expression of ideas, experiences and emotions in a range of media (music, performing arts, literature and the visual arts).

The essence of Key Competencies is that they should be acquired by young people at the end of their compulsory education and training. This will equipped them for adult life, particularly for working life by forming a basis for further learning. In parallel adults should obtain KC throughout their lives in a process of developing and updating skills. The acquisition of KC fits in with the principles of equality and access for all. This reference framework applies in particular to disadvantaged groups whose educational potential requires support. ICT seems to be a perfect media to support process of teaching and learning and to help in overcoming diversity of the target groups.

The Key Competencies are all interdependent and intertwine different aspects such as critical thinking, creativity, initiative, problem solving, risk assessment, decision taking and constructive management of feelings. All of them appear crucial in nowadays educational environment especially when using ICT.

3. Multimedia in Physics Teaching and Learning

Teaching and learning practices in physics are impacted by the expectations for cooperation and engagement of students and are supported by the wide selection of ICT tools and multimedia resources. This is especially visible in the most of comments and extensively examined physics teaching approaches as IBSE [PATHWAY 2015] and QtA [Beck 1997] which could be hardly applied without an extensive use of ICT. Therefore usage of ICT technology is in line with development of teaching and learning methods. We believe that in such circumstances special attention should be focused on secondary education, university education, and teacher education. Many educators and researchers are developing and using a variety of educational materials that make use of simulations, virtual laboratories, videos of real and animated experiments, and online tutorials based on well-established didactic methods [Dębowska 2013].

¹ Abbreviations for certain Key Competencies has been proposed by the authors and will be used further in the text.

As we are fortunate in physics to have many collections of high-quality ICT resources freely available and easily accessible via the internet [Dębowska 2013], physics is considered as a subject whose main interest is directly and strongly connected with three out of eight Key Competencies, namely: (1) CMT - communication in the mother tongue, (2) MCST - mathematical competence and basic competencies in science and technology, and (3) DC - digital competence. Therefore an obvious question may arise – are there KC which can be formed only or with more chance for success by physics and ICT tools than by any other subject? And in addition how can these competencies be taught and how can students acquire them through a modern technology?

Authors' experience gathered when working with students at University of Wrocław, Faculty of Physics and Astronomy as well as during international projects e.g. "MOSEM" [Simplicatus 2010] and "Photonics Explorer" [CORDIS 2010] and national educational projects e.g. "School of Key Competencies" [Szkoła 2014] and "Diamond Grinding" [Fem 2014] resulted in attempting to formulate the Key Competencies Model (KCM). During formulation of the model's assumptions special attention was devoted to emphasizing that ICT tools and activities were particularly necessary for personal fulfilment and development, social inclusion, active citizenship, and employability.

A group of physicists associated with the MPTL - international conference on Multimedia in Physics Teaching and Learning (since 1996) - performs the reviews resulting in the recommendation of materials useful in preparation of activities devoted to different subject areas in physics [Dębowska 2013]. As the authors of the paper are involved in this annual activity they would like to illustrate the proposed model of Key Competencies with recommended materials. When introducing new components of the model we connect the examples of suitable and good quality multimedia materials with certain KC which in our opinion could be particularly fostered by them.

In authors opinion the proposed model brings us closer to answer the question posed at the second paragraph of this chapter. We are eager to extend the starting list of three KC up to all eight ones. To support such a statement we first would like to introduce the integrated model of competencies in the educational process proposed by T. Czapla in [Czapla 2013] and then redefine its components to show connection with multimedia used in physics teaching and learning.

4. Model of Key Competencies

Bases of the model

The Czapla's model is based on the three pillars: structuralism, phenomenology, and behaviourism and arose from the assumption that wide fields of acquiring competencies could be located in two areas – rational and emotional. This is presented in the graphical form in fig. 1. The field of competence is outlined by intersecting of two triangles which tops are ability (blue) and attitude (brown). The upper so called rational triangle is supplemented by knowledge and understanding, when bottom emotional triangle is composed of values and beliefs. The common part of two triangles marks potential scope of the Key Competencies but one should noticed that also additional elements named together as Environment have essential influence on shaping of the KC. This model includes dynamic aspects of shaping KC from both rational (developing abilities) and emotional (developing attitudes) sides. Different aspects and processes have been recognized as elements that connect certain components of the model – they are portrayed on arrows pointing to vertices of the triangles [Czapla 2013].

Our redefined model presented in fig. 2 consists of two triangles from which the first represents the elements of physics teaching and learning (blue) and the second one the key items of modern technology (brown). Therefore we call the upper triangle education oriented when the bottom one is named multimedia oriented. This new integrated model of competencies associates well known elements of KC with activities and ICT tools and multimedia used in physics teaching and learning. Instead of "values of the organizational culture" as environment component in Czapla's model our environment component consists of real and virtual worlds. The blue triangles in both models shear some elements but their general nature differs significantly. Its rational character in the first model has been weakened by replacing ability with attitudes which resulted in introducing new components: usefulness and expectations.

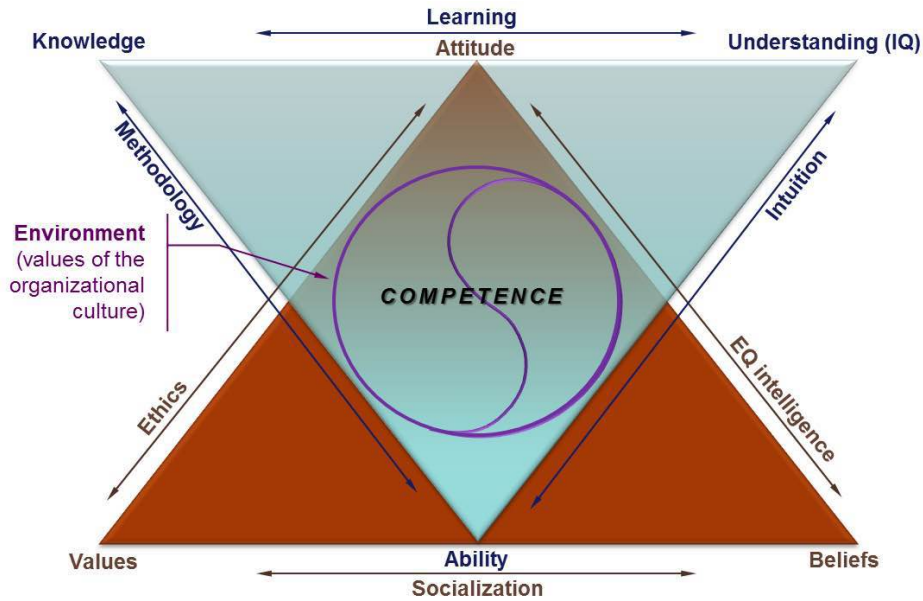

Figure 1. Scopes of the Czapla's model [Czapla 2013]

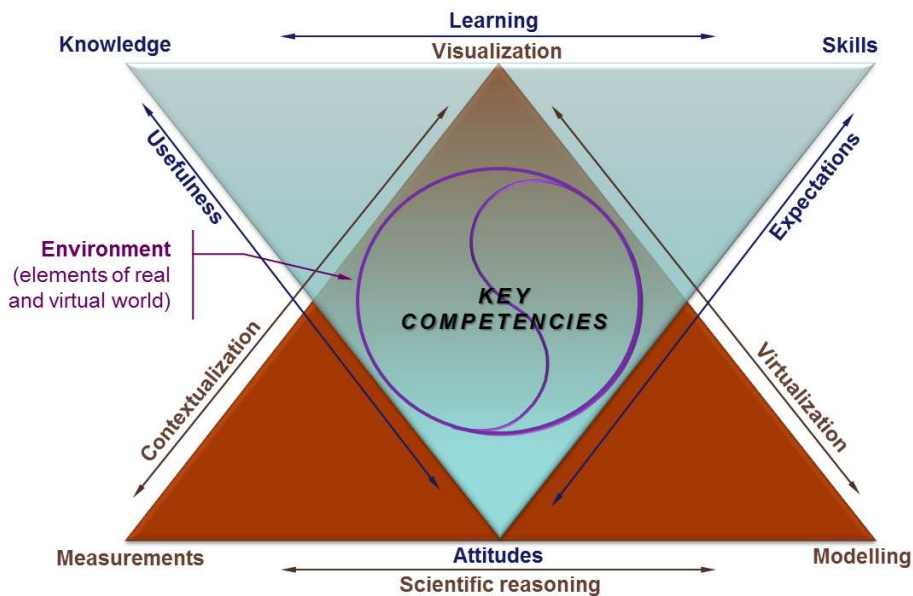

Figure 2. Our model of competencies in the educational process – details in the text

Components of the model

The initial model of competencies in the educational process is well described in [Czapla 2013] so we will limit our discussion to the new one only. As we would like to make direct connections between new components and all Key Competencies, the abbreviations introduced in the chapter Key Competencies will be used. The new components in our model are:

Visualization – a process of creation images, diagrams or animations to communicate both abstract and real ideas. In the model, this action supports learning which connects Knowledge and Skills. Visualization is especially important in development of MCST and CAE. Model example of ICT tools recognized by MPTL review is a series of high quality simulations and illustrations of many electromagnetic topics with focusing on visualization of electric and magnetic fields: MIT: TEAL E&M Simulations

<http://web.mit.edu/8.02t/www/802TEAL3D/index.html>

Modelling – a process of construction and use of a model of a physical system. This is the essential component of multimedia recognized and used in various science disciplines. Modelling not only supports learning but is able to give results of a new value. This element is essential when building DC and LL. Good example of multimedia that foster acquiring of KC is a wide collection of resources from different authors, all built on the Easy Java Simulations platform: Open Source Physics: E&M Modelling Resources in Easy Java Simulations

<http://www.compadre.org/osp/search/search.cfm?gs=224&b=1&qc=Modeling>

Virtualization – an act of creation effects or conditions in not real environment, for example on a computer or in a digital space. This process connects Visualization and Modelling and plays important role in benefiting from a variety of ICT tools widely available in the internet. Virtualization is critical for development of CMT, SCC, and CAE. Virtualization could be illustrated with extensive collection of Flash-based tutorials with interactive simulations of quantum systems and step-by-step explanations of the concepts involved related to student activities and didactic recommendations: QUVIS

<http://www.st-andrews.ac.uk/physics/quvis/>

Measurements – an act of measuring resulting in gathering certain data. This is the crucial activity in physics teaching and learning and indispensable component of KC formation. Modern measuring procedures and tools allow shaping of CMF ad DC. As a well-known example of an ICT resource of measurements are remotely controlled laboratories, where real experiments can be executed through the internet: Remotely Controlled Laboratories – RCLs

<http://rcl-munich.informatik.unibw-muenchen.de/>

Scientific reasoning – a type of reasoning characterized by thinking in terms of abstractions or symbols, being able to think about many variables or dimensions at once and in terms of probabilities and proportions with use of a specific methodology (testing of hypothesis) [Herr 2007]. This kind of reasoning bridges Measurements and Modelling and plays an important role in Attitudes creation. This component of a model is crucial for development of MCST. A set of resources that use videos for student exploration in a learning cycle is noteworthy in this respect, as the explorations provide the learning goal, prior knowledge and one or more predictions and follow-up questions: Rutgers: Learning Cycles on Electricity and Magnetism

<http://paer.rutgers.edu/PT3/cycleindex.php?topicid=10>

Contextualization – the act or process of putting information into context; making sense of information from the situation or location in which the information was found. The level of performance depends on several factors and the capacity for listening, speaking, reading, writing and understanding. Contextualization joins Measurements and Visualization and is central for development of LL, SIE, and CAE. This aspect is present in the online textbook supplement of interactive illustrations and problems which exemplify quantum properties: Physlet Quantum Physics

<http://www.compadre.org/ppq/>

Usefulness – a quality of having a value and especially practical applicability. This has been recognized as a key factor which links Knowledge and Attitudes. It is necessary to mention that the factor includes awareness of ethical values (among others: authors' properties and rights). It is also linked to personal and social well-being. An understanding of the rules of behaviour and customs in the different backgrounds in which we operate is essential. Several KC can be shaped by the specific characteristics of ICT tools. As an example of ICT resource a tutorial which includes theory, virtual experiments and self-tests for learners associated with a simple introduction to electric circuits may serve: British Energy Electric Circuits

<http://resources.schoolscience.co.uk/BritishEnergy/11-14/index.html>

Expectations – a feeling or belief about anticipated effects of taken steps which involve an understanding of the changes caused by human activity and the responsibility of each individual. Expectations are joining Skills and Attitudes and are important in building the following competencies: LL, SIE, and CAE. Almost all complete ICT courses suit this category, for example the collection of materials which provides a series of research-based interactive environments for students with a number of lesson plans created by instructors and researchers: PhET: Electricity, Magnets, and Circuits

<http://phet.colorado.edu/en/simulations/category/physics/electricity-magnets-and-circuits>

The components presented above create core of the model and underline its direct connections with already existing materials, tools and ideas. They also structuralize the most important characteristics of information and communication technology, not only those devoted to teaching and learning physics but more broadly in educational multimedia resources.

5. Conclusions

Redefined Key Competencies Model of crucial elements in formation of Key Competencies through Information and Communication Technology has been presented and discussed. Its acceptance leads to the conclusion that ICT plays important role in the process of KC shaping. As a result there is a need to change the role of a teacher from a knowledge supplier to the administrator of a broad set of tools and originator of the KC building process.

Further study should be conducted to make sure of the model usefulness and accuracy and establish how deeply certain actions facilitate development and building of specific KC and at what level it involves creativity, innovation and risk-taking, as well as the ability to plan and manage projects in order to achieve assumed objectives.

Another extremely important question that should be answered is what are the research priorities in enriching understanding and development of KC through physics teaching and learning associated activities? Moreover what are Key Competencies which are expected from our student on the job market or even more broadly what are Key Competencies that non-academic educated person can obtain when using ICT? We believe that further study will bring us closer to the answers in this matter.

References

- Beck, I.L. McKeown, M.G. Hamilton, R.L. Kugan, L. (1997). *Questioning the author: An approach for enhancing student engagement with text*. Newark, DE: International Reading Association.
- CORDIS website, http://cordis.europa.eu/project/rcn/94791_en.html, (Accessed 20/11/2014).
- Czapla, T. (2013). Integrated model of competence in the educational process of the student. In Teczke, J. Terblanche, N. (Eds), *Management Science in Transition Period in South Africa and Poland* (pp. 427-435). International Management Foundation, Cracow: University of Economics.
- Dębowska, E., Girwidz, R., Greczyło, T., et al. (2013). Report and recommendations on multimedia materials for teaching and learning electricity and magnetism, *Eur. J. Phys.* **34**, L47-L54.
- EUR-Lex. (2006). Recommendation 2006/962/EC of the European Parliament and of the Council of 18 December 2006 on key competencies for lifelong learning, *Official Journal L* **394**/10 of 30.12.2006.
- FEM website, <http://fem.org.pl/szlifowaniediamentow/>, (Accessed 20/11/2014).
- Herr, N. (2007). *The Sourcebook for Teaching Science – Strategies, Activities, and Instructional Resources*, John Wiley/ Jossey-Bass Publishers, San Francisco. CA.
- MPTL website, <http://www.mptl.eu/>, (Accessed 20/11/2014).
- PATHWAY – UK, <http://www.pathwayuk.org.uk/what-is-ibse.html>, (Accessed 06/03/2015).
- Reynolds, N. Tucsányi-Szabó, M. (Eds.). (2010). *Key Competencies in the Knowledge Society*, Proceedings of IFIP 2010, Brisbane, Australia.
- Reynolds, N. Webb, M. Sysło, M. M. Dagienė, V. (Eds.). (2013). *Learning while we are connected*, Proceedings of WCCE 2013, Toruń, Poland.
- Simplicatus Research and Development AS, Lillestrøm, Norway (Eds.) (2010) *MOSEM Teacher Guide, Minds-On experiments in Superconductivity and ElectroMagnetism*, Trondheim, Norway: NTNU-trykk.
- Szkoła kluczowych kompetencji website, <http://edycja2.kluczowe-kompetencje.pl/>, (Accessed 20/11/2014).
- White, R. (1959). Motivation reconsidered: the concept of competencies, *Psychological Review* no. **66**, 297-333.
- Zacharia, Z.C., Constantinou, C. P., Papaevripidou, M. (Eds.). (2010). *Application of New Technologies in Science and Education*, Proceedings of CBLIS 2010, Warsaw, Poland

Affiliation and address information

Tomasz Greczyło
Institute of Experimental Physics,
University of Wrocław
pl. Maksa Borna 9
50-204 Wrocław, Poland
e-mail: greczylo@ifd.uni.wroc.pl

Comparing Methods of Measurement of Friction with Simple Equipment and with Data-Loggers

Kamila Hrabovská¹, Libor Koníček², Libuše Švecová², Karla Barčová³

¹*Institute of Physics, VŠB -Technical University of Ostrava, Czech Republic*

²*Department of Physics, Faculty of Science, University of Ostrava, Czech Republic*

³*Department of Security Services, Faculty of Safety Engineering, VŠB -Technical University of Ostrava, Czech Republic*

Abstract

The Physics of friction is an important topic in the teaching of Physics at schools of all types and also of our everyday interest. Students, however, are often unable to imagine the applicability of what they learn to real-life situations, therefore, experiments should be an integral part of the teaching and learning of Physics. The main objective of these experiments is to demonstrate dynamic friction on either a horizontal or inclined plane with commonly used surfaces. All experiments have been designed as such that they are not difficult for students and teachers and, at the same time, they use the basic concepts of friction to measure the coefficient of dynamic friction. The article presents a newly constructed school tribometer, which is accessorized with Vernier sensors in the Physics classroom to demonstrate problems in the mechanics curriculum for middle schools, high schools and universities. The inclining tribometer enables taking measurements for the following types of problems:

- Finding the coefficient of static and dynamic friction for motion
- Finding the coefficient of rolling friction
- Measuring the kinematic quantities of a body moving on horizontal and inclined planes
- A tribometer construction may also be used to demonstrate fibre friction.

Another significant advantage of this inclining tribometer is its angle, which lies in the range between -90° and 90° . This enables measurements of surfaces with very high dynamic friction coefficients. An extensive literature search did not show the same tribometer construction and its use. The methods of finding the dynamic friction coefficient described in the text are:

- Determination of coefficient of sliding friction by measuring the tensile force on the horizontal school tribometer (inclination angle 0°)
- Determination the coefficient of sliding friction through with the aid of changing the inclination of the tribometer

Both methods were developed with simple equipment and data-logging software. This article compares the advantages and disadvantages of school experiments with and without data-logging software. Both methods described above make use of data-logging sensors by Vernier which, when connected to a PC, make tutorials more effective and also enable more exact measurements and data analysis, show graphs and make it possible to determine the uncertainty of measurements. The uncertainty of the coefficient of sliding friction is lower when using the Vernier system than with the methods of ordinary school equipment. Vernier data-loggers enable us to measure several quantities simultaneously and display the relationship between them. Data can be transferred to other programs and can be saved for later data analysis. Using Vernier data-loggers also helps students be more competent in the use of ICT.

Keywords

Secondary education: lower (ages about 11-15), Secondary education: upper (ages about 15-19), University education, friction, coefficient of friction, tribometer, ICT

1. Introduction

The theory of friction was developed by Charles-Augustin de Coulomb (1785). Coulomb investigated the influence of four main factors on friction: the nature of the materials in contact and their surface coatings; the extent of the surface area; the normal pressure; and the length of time that the surfaces remained in contact. The distinction between static and dynamic friction is made in Coulomb's friction law, although this

distinction was already drawn by Johann Andreas von Segner in 1758. The new discipline called tribology raised from the need of linking science with technology in the areas of friction.

Any product where one material slides over another is affected by complex tribological interactions. The study of tribology plays an important role in manufacturing and modern technology. In technology operations, friction increases wear machine and the power required to work. This results in increased costs [Wahl, Nature materials, 2012]. The use of lubricants minimize direct surface contact reduces wear machine and power requirements [Braun, Surface Science Reports, 2006, Harnoy, IEEE control systems magazine, 2008].

Since the 1990s, new areas of tribology have emerged, including the nanotribology. These interdisciplinary areas study the friction, wear and lubrication at the nanoscale, for example: materials in biomedical applications [Rubin, Wear, 2013].

2. Technical description of the newly designed school inclining tribometer

The tribometer consists of a steel base plate with the dimensions of 300x200x25 mm, which gives us stability. The axis of the top of the base plate is fixed with a screw connection supporting a steel rod with a length of 520 mm, at the end of which a movable joint is mounted via a hinge and locking hex bolt (locking the set angle of incline) and the test surface with a length of 1000 mm and a width of 100 mm. The test area, made of waterproof plywood, is fitted with plastic strips on the sides to prevent buckling of the testing body while moving along the test area. The test area allows you to change the type of pairs of friction materials. A metal workshop protractor with the possibility of adjusting the angle in the range from -90° to 90° with a resolution of 1° is fixed in the joint axis on the test area. The design of the tribometer enables measuring frictional force, using adjustable rollers and fibres, during the movement of the testing body along a horizontal plane as well as along inclined plane. The metal tribometer construction is equipped with a protective coating against corrosion [Hrabovská, Bachelor thesis, 2013].



Figure 1. Newly designed school inclining tribometer [Hrabovská, Bachelor thesis, 2013]

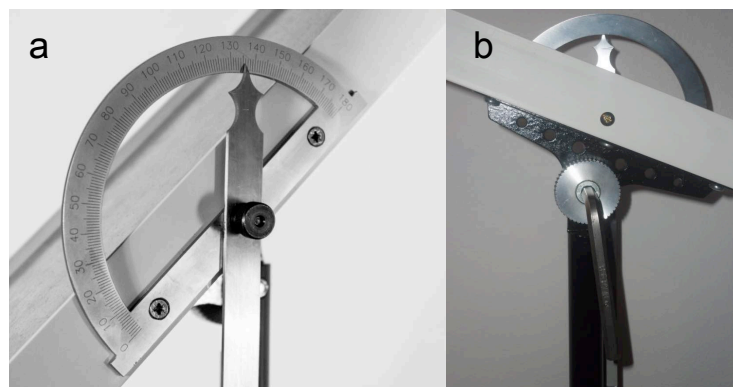

Figure 2. a) Universal protractor attached to the inclining tribometer b) Securing the position of the inclining tribometer with an Allen screw [Hrabovská, Bachelor thesis, 2013]

Test friction the body

Material of the removable tribometer test pad: Spruce wood, shaped by grinding

Materials friction body: Spruce wood shaped by grinding, Perspex, Sand paper P180

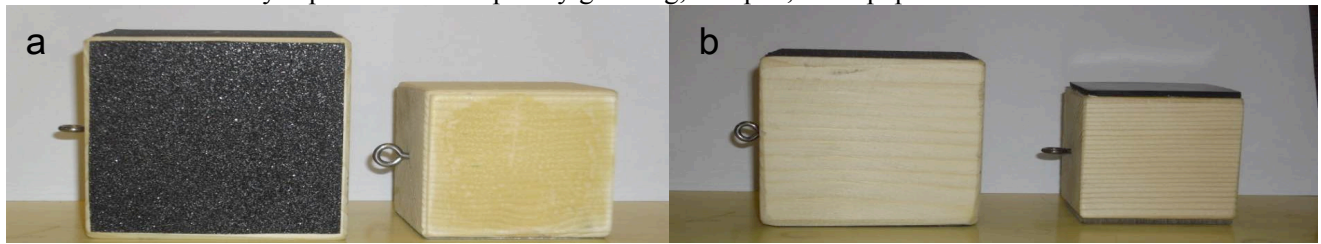

Figure 3. Body provided with a friction surface a) Sand paper P180, Perspex, b) Spruce wood [Hrabovská, Bachelor thesis, 2013]

Surface roughness

Measurement of surface roughness of test bodies and removable pads was performed using a Mitutoyo SurfTest – 301. The profile of the surface material was obtained by using a touch sensor. The room temperature and air-movement in the lab were controlled.

Table 1. Comparison of roughness parameters of individual friction surfaces [Hrabovská, Bachelor thesis, 2013]

Surface roughness	Material (removable pad - Spruce wood)	Material (test body - Spruce wood)	Material (test body - Perspex)	Material (test body - Sand paper P180)
R_a (μm)	8,88	6,68	0,02	23,92
R_z (μm)	54,47	38,93	0,17	171,60

R_a – arithmetical mean deviation of the assessed profile

R_z – the highest elevation of the profile

Parameters R_a , R_z used for the basic evaluation of surface roughness of the material.

Measuring the weight of friction test bodies was performed using OHAUS EXPLORER PRO accurate analytical balance to 620g. The room temperature and air-movement were controlled in the lab.

3. Methods of measurement

Two bodies of different masses were used to find the coefficient of static and dynamic friction for each pair of surfaces. Each measurement was repeated 10 times and the average value of the friction coefficient was calculated.

Determination of coefficient of sliding friction by measuring the tensile force on the horizontal tribometer (inclination angle 0°)

The tribometer unit was set in a horizontal position using a spirit level and metal workshop protractor. The tribometer test area was equipped with a removable wooden surface.

The body was pulled along the tribometer sliding test area using spun bond fibre routed through a pulley, which is attached to the tribometer frame. At the other end of the fibre a hanging bowl was attached to hooks. The bowl was gradually loaded with weights until the body started to move. The tensile force caused by the gravitational force of weights and bowls on the test body is transmitted by the fibre. In this case, the ratio of tensile force to the force of gravity on the test body gives the static coefficient of friction.

When measuring the dynamic coefficient of friction, the mentioned test body was set in motion by a slight impact on the bowl. The weights were set in constant motion. The type of movement was estimated. The ratio of tensile force which corresponds to the constant motion of the test body and the force of gravity, gives the dynamic coefficient of friction [Mechlová, 1999].

Let us consider the cuboid body mass m , which moves along the horizontal surface and which is constantly force \vec{F}_1 in the direction of its movement.

If $\vec{F}_1 = \vec{F}_t$, the body is still or movement takes place at a constant speed. The static coefficient of friction will apply:

$$\vec{F}_{t0} = \vec{F}_N f_0, \quad f_0 = \vec{F}_{t0} / \vec{F}_N = (\vec{g} m_{z0}) / (\vec{g} m) = m_{z0} / m$$

m_{z0} - Amount of weight for static friction, m - the weight of the test body, \vec{F}_{t0} - frictional force for static friction, \vec{F}_N - normal force, \vec{g} - acceleration of gravity.

Dynamic coefficient of friction:

$$\vec{F}_t = \vec{F}_N f, \quad f = \vec{F}_t / \vec{F}_N = (\vec{g} m_z) / (\vec{g} m) = m_z / m$$

m_z - Amount of weight for dynamic friction, \vec{F}_t - frictional force for dynamic friction

Table 2. Average Values of the coefficients of friction, inclination angle 0 °, [Hrabovská, Bachelor thesis 2013]

Friction materials	m (g)	m_{z0} (g)	m_z (g)	f_0 (1)	f (1)
Spruce wood-	$m_1=138,507$	93,862	91,691	0,678	0,664
Spruce wood	$m_3=256,800$	205,407	201,239	0,800	0,784
Spruce wood-	$m_1=138,507$	45,692	38,632	0,330	0,279
Perspex	$m_3=256,800$	72,216	67,609	0,281	0,263
Spruce wood-	$m_2=102,014$	90,541	84,349	0,888	0,827
Sand paper P180	$m_4=216,040$	219,696	200,035	0,971	0,926

Determination of the coefficient of sliding friction by measuring the tensile force of the horizontal tribometer (inclination angle 0 °, Vernier system)

The body was pulled along the tribometer sliding test area using spun bond fibre routed through a pulley, which is attached to the tribometer frame. A Vernier force sensor was mounted at the other end of the fibre using hooks. The load cell was gradually loaded manually until the body was set in motion. The tensile force is transmitted by the fibre. The intensity of the gravitational force exerted on the body on the sliding test pad was measured by the Vernier load cell. The ratio of tensile force to the force of gravity on the sliding test body gives the static coefficient of sliding friction.

Let us consider the cuboid body mass m , which moves along the horizontal surface and which is constantly force \vec{F}_1 in the direction of its movement. If $\vec{F}_1 = \vec{F}_t$, the body is standing still or movement takes place at a constant speed. The static coefficient of friction will apply:

$$\vec{F}_{t0} = \vec{F}_N f_0, \quad f_0 = \vec{F}_{t0} / \vec{F}_N$$

Dynamic coefficient of friction:

$$\vec{F}_t = \vec{F}_N f, \quad f = \vec{F}_t / \vec{F}_N$$

\vec{F}_N - Normal force (Vernier force sensor)

During measurement of the dynamic coefficient of sliding friction, the mentioned test body was placed into an evenly linear motion. Determining the type of movement was controlled by measuring the position and by Vernier motion sensors [Vernier 2014]. The ratio of tensile force and gravitational force on the sliding test body gives the dynamic coefficient of friction.

Vernier sensors used: LabQuest mini sensor, position and motion sensor, force sensor

Table 3. Average values of the coefficients of friction, inclination angle 0° , Vernier system, [Hrabovská, Bachelor thesis, 2013]

Friction materials	m (g)	F_N (N)	F_{t0} (N)	F_t (N)	f_0 (1)	f (1)
Spruce wood- Spruce wood	$m_1=138,507$	1,483	0,544	0,403	0,367	0,272
	$m_3=256,800$	2,672	0,799	0,554	0,299	0,207
Spruce wood- Perspex	$m_1=138,507$	1,483	0,370	0,301	0,249	0,203
	$m_3=256,800$	2,672	0,447	0,389	0,167	0,145
Spruce wood- Sand paper P180	$m_2=102,014$	1,124	0,895	0,854	0,797	0,760
	$m_4=216,040$	2,247	1,945	1,543	0,866	0,687

Determination the coefficient of friction through direct measurement of the angle with the school tribometer

The method is based upon moving a test body along the inclined plane of the tribometer, which allows altering the angle of inclination. The test body starts to move at the point when the angle of inclination is being increased. The angle at which this happens is called the friction angle and it allows us to determine the coefficient of friction. This method makes no use of data-loggers.

The testing surface of the tribometer was set in a horizontal position, using a spirit level and universal workshop protractor. The coefficient of static friction was determined by the school tribometer, whose angle of inclination we can alter and measure. The sliding test body was placed on the tribometer and the angle was increased until it begun to move. In this case, the following equality is satisfied:

$$\vec{F}_p = \vec{F}_t$$

$$mg \sin \alpha_0 = f_0 mg \cos \alpha_0$$

\vec{F}_p - movement force

Therefore, the coefficient of static friction is $f_0 = \tan \alpha_0$

The coefficient of dynamic friction f depends on the angle α , which is the friction angle [Mechlová, 1999]. The friction force and the normal force are mutually perpendicular, therefore:

$$f = \vec{F}_t / \vec{F}_N = \tan \alpha$$

The angle of inclination was set such that the test body followed a uniform motion. That occurs only when the angle of inclination is equal to α .

Table 4. Average values of the coefficients of friction, friction angle, [Hrabovská, Bachelor thesis, 2013]

Friction materials	m (g)	Friction angle α_0 ($^\circ$)	Friction angle α ($^\circ$)	f_0 (1)	f (1)
Spruce wood- Spruce wood	$m_1=138,507$	23,3	17,2	0,431	0,310
	$m_3=256,800$	22,7	16,6	0,418	0,298
Spruce wood- Perspex	$m_1=138,507$	19,1	16,9	0,346	0,304
	$m_3=256,800$	19,1	16,8	0,346	0,302
Spruce wood- Sand paper P180	$m_2=102,014$	37,1	36,1	0,756	0,729
	$m_4=216,040$	37,4	35,8	0,765	0,725

Determination of the coefficient of friction through finding the friction angle with the school tribometer (Vernier system)

The testing surface of the tribometer was set in a horizontal position, using a spirit level and universal workshop protractor, and a 3-D sensor for acceleration due to gravity was attached. The 3-D sensor measures the x, y and z components of acceleration due to gravity and it was used to measure the angle of the tribometer testing plane. The sensor was attached to the pivoted joint of the inclining tribometer. The x axis was chosen to be along the testing plane of the tribometer, y axis was perpendicular to it (vertical). The z component of acceleration was zero. The 3-D acceleration sensor was connected to CH 1 of the LabQuest, which was connected to a PC. The settings on the Logger Lite programme were as follows: Duration of sample 10 s, sampling frequency: 50/s [Vernier, 2014].

The sliding test body was placed on the tribometer testing plane. The angle of inclination was increased until the body began to move. Vernier data-loggers enabled us to find the x, y components of the acceleration and the friction angle was found as $\tan \alpha_0 = a_y/a_x$.

At the moment when the test body begins to move:

$$\vec{F}_p = \vec{F}_t$$

$$mg \sin \alpha_0 = f_0 mg \cos \alpha_0$$

And therefore the coefficient of static friction is:

$$f_0 = \tan \alpha_0$$

Coefficient of dynamic friction is:

$$f = \tan \alpha$$

When the coefficient of dynamic friction was measured, the test body was moving at a constant speed down the plane, which was monitored by the Vernier position and motion sensor.

Vernier sensors used: LabQuest mini sensor, position and motion sensor, 3D gravitational acceleration sensor (up to 5 g).

Table 5. Average values of the coefficients of friction, friction angle, Vernier system [Hrabovská, Bachelor thesis, 2013]

Friction materials	m (g)	Friction angle α_0 (°)	Friction angle α (°)	f_0 (1)	f (1)
Spruce wood-	$m_1=138,507$	27,377	26,428	0,518	0,497
Spruce wood	$m_3=256,800$	26,378	25,886	0,496	0,485
Spruce wood-	$m_1=138,507$	17,244	16,826	0,310	0,302
Perspex	$m_3=256,800$	17,140	16,921	0,308	0,304
Spruce wood-	$m_2=102,014$	33,472	32,758	0,661	0,643
Sand paper P180	$m_4=216,040$	33,269	32,296	0,656	0,632

4. Results and discussions

The measurement results correspond to the theoretical dependencies. The measurements were validated by the relationship between the coefficient of friction, frictional force and normal force. It was confirmed by the dependence of the coefficient of friction on the angle of the inclined plane. The work verified the claim that the static coefficient of friction is greater than the dynamic coefficient of friction.

Measuring the surface roughness characteristics of the sliding bodies and removable tribometer pad was performed using the surface-sensitive method (contact profilometer). This measurement describes in detail the surface roughness. Impaired quality and higher roughness parameters effect the results of the coefficients of sliding friction, thus the coefficients acquire higher values.

The coefficients of the friction of wood are mainly influenced by uneven surface morphology. The morphology of the surface of the wood is set by its anatomical structure and the method of mechanical processing. Wood surfaces have defects (tree rings, knots, cracks and burrs).

5. Conclusion

Contribution of this work is the validation of the current knowledge concerning the measurement of the coefficient of friction by using commonly available tools in the student laboratory, as well as using the Vernier measurement system.

The results of measurement are in accord with common theories. The validity of the relationships between the coefficient of dynamic friction, frictional force, normal reaction and the angle of inclination were confirmed. They also enhance student understanding that friction can be useful (braking, motion, rubbing and grinding) as well as a nuisance (unwanted deceleration, heating effects in machinery). The use of ICT in teaching allows publication of experiences and sharing them with the educational community.

Acknowledgements

This article was supported by the project: SGS22/PřF/2014.

References

- Braun, O. M., Naumovets, A. G. (2006). Nanotribology: Microscopic mechanisms of friction, *Surface Science Reports*, Volume 60, Issues 6–7, 79-158, ISSN: 0167-5729
- Harnoy, A ; Friedland, B ; Cohn, S. (2008). Modeling and Measuring Friction Effects Physics, Apparatus, and Experiments, *IEEE control systems magazine*, Volume: 28, Issue: 6, 82-91, ISSN: 1066-033X
- Hrabovská, K. *The Physical Fundamentals of Friction and its Measurement*. (2013). Ostrava, Bachelor thesis. University of Ostrava, Faculty of Science, Department of Physics.
- Mechlová, E., Košťál, K., aj. (1999). *Výkladový slovník fyziky pro základní vysokoškolský kurz*. Praha: Prometheus, 126-129. ISBN 80-7196-151-5.
- Rubin, A, Gauthier, C, Schirrer R. (2013). Analysis of the effect of nano-roughness on the friction of a vitreous polymer, *Wear*, Volume 303, Issues 1–2, Pages 40-48, ISSN: 0043-1648
- Wahl, kj. (2012). Applied physics and interfaces Positively 'negative' friction, *Nature materials*, Volume: 11, Issue: 12, 1004-1005, ISSN: 1476-1122
- www.vernier.com. [online]. [cit. 2014-05-23]

Affiliation and address information

Kamila Hrabovská
Institute of Physics
VŠB -Technical University of Ostrava
17. listopadu 15, 708 33 Ostrava-Poruba, Czech Republic
e-mail: kamila.hrabovska@vsb.cz

Libor Koniček, Libuše Švecová
Department of Physics
Faculty of Science
University of Ostrava
30. dubna 22, 701 03 Ostrava, Czech Republic
e-mail: libor.konicek@osu.cz, libuse.svecova@osu.cz

Karla Barčová
Department of Security Services
Faculty of Safety Engineering
VŠB -Technical University of Ostrava
Lumírova 13/630, 70030, Ostrava-Výškovice, Czech Republic
e-mail: karla.barcova@vsb.cz

Implementation of an In-Service Course on Integration of ICT into Inquiry Based Science Education: A Case Study in Slovakia

Zuzana Ješková¹, Trinh-Ba Tran², Marián Kireš¹, Ton Ellermeijer³

¹ Pavol Jozef Šafárik University in Košice, Slovakia

² VU University Amsterdam, the Netherlands

³ Foundation CMA, the Netherlands

Abstract

In the framework of the ESTABLISH project, a variety of support materials for teacher learning about the application of technological tools in inquiry-based science lessons were developed. These materials are organized in a Moodle platform and meant for the blended approach, enabling effective courses with limited life sessions and in different educational contexts. Besides case studies with pre-service teachers in the Netherlands, these materials were used in Slovakia for in-service training in the context of an accredited course at Pavol Jozef Šafárik University in Košice. In this course the ICT tools for data logging, video measurement, and modeling, integrated in the Coach learning environment were introduced. Before the course, many teachers did not have any experience with the Coach tools, the modeling tool, in particular, while others were just moderately or slightly familiar. The teachers' theoretical knowledge about the intentions of inquiry-based teaching was good, but they still had problems in developing and carrying out an inquiry-based lesson plan in the classroom.

In the case study on the implementation of the course, a variety of research methods (i.e. observation, questionnaires, and documents) were designed and used to collect data on the teachers' learning process and outcomes. The positive course results proved the successful application of the blended set-up in which traditional workshop sessions were extended appropriately with the home assignments and the final assignment with presentation of teachers' lesson plans, which supposedly incorporated what they learnt in the life sessions. The teachers became aware of educational benefits of the ICT tools and were motivated to apply the ICT activities in the classroom. Their familiarity and confidence with the ICT tools increased remarkably. The main goal was attained as 37 teachers (out of 39) could develop their own Coach activities and design their inquiry-based lesson plans enhanced by the ICT tools. The main obstacle during the course implementation was that the teachers had little experience with the ICT tools. As a result, the teacher trainer had to explain concepts and manipulations in detail but always under the time constraint. On the other hand, the teachers complained of too much new information to follow and remember, about the modeling tool, in particular. Consequently, some advanced skills were not achieved as expected. In this case, the online platform for the distance learning mode where teachers could access support materials and receive timely feedback became very helpful. The crucial issue was how to keep teachers on task and continue when facing technological problems.

Keywords

In-service teacher education, ESTABLISH, IBSE, ICT, Coach, datalogging, videomeasurement, modeling

1 Introduction

1.1 The ICT element of the ESTABLISH teacher-education programs

The Rocard report (2007) indicates the European Community's desire to change science education in direction of inquiry-based methods. Today several large EC-funded projects involving many countries are addressing this challenge. The main focus lies on preparing and supporting teachers by providing them with innovative curriculum materials and teacher training activities (Ellermeijer, 2013). In the framework of the ESTABLISH project (<http://www.establish-fp7.eu/>), the teacher education programs were built around teaching and learning units that consist of a common core supported by additional materials and resources to address aspects of implementation of Inquiry Based Science Education (IBSE) within real classrooms. The core is then supported by a number of other elements that can be implemented as required to suit local teachers, environment, curriculum etc. (Kedzierska et al., 2013).

For a long time we have known that ICT might stimulate and enable science education in a direction that brings students in a similar position as researchers in science. However, many teachers still have not been able to use the ICT tools in the classroom due to lack of training. Therefore, one of the supporting elements, called "ICT in IBSE teacher-training course", focused on the development of teacher confidence and competence in the effective use of ICT in IBSE. Among ICT applications, the following ICT tools are considered crucial in order to enhance science education in general and inquiry in particular:

- *Data logging* tool enables to gather and record real-time data by sensors.
- *Video measurement* tool enables to collect position and time data from a video of a moving object.
- *Modeling* tool provides teachers and students with a powerful set of possibilities to create and analyze models of science systems. It should be differentiated from animation or simulation.
- *Data processing and analysis* tool helps to analyze or process the data, which is collected by data logging, video measurement, or modeling.

These four ICT tools are integrated in the Coach learning environment (<http://cma-science.nl/>) that was used as the main learning platform of this ICT-in-IBSE teacher-training course. Considering this fact, we will refer to the activities developed in the Coach environment as Coach activities. When talking about ICT tools, we will mean these specific four tools. More details about these ICT tools of the Coach system can be found in Heck et al. (2009).

Within the ICT-in-IBSE teacher-training course, a variety of support materials have been developed and organized in the Moodle environment (<http://ibse.establish-fp7.eu/>) to support blended set-ups (incl. life meetings and home assignments) in different educational contexts. The Moodle environment is now open for every teacher and teacher trainer to utilize. The Coach activities are for teachers to learn how to use a particular tool, divided into three categories:

- *Coach basic activities* are ready-to-use activities, which introduce simple manipulations and elementary concepts related to a certain tool. Practicing these basic activities does not require any previous experience with the Coach platform.
- *Coach tutorial activities* help to improve skills corresponding to a certain tool through step-by-step written instructions or video tutorials.
- *Coach subject activities* are ready-to-use activities focused on a particular topic or concept (e.g. damped oscillation), which serve as a source of ideas or as a resource for further development.

The PPT slides, background articles, and ESTABLISH units are for teachers to become aware of educational benefits and possible applications of ICT tools in science education as well as to learn how to integrate these tools into a particular inquiry-based lesson.

The ICT-in-IBSE teacher-training course has been adapted and implemented in two countries. Besides tryouts with pre-service teachers in the Netherlands (Tran et al., 2014), the materials and the blended approach were already applied in Slovakia, but for an in-service course. This paper will present the adaptation of the course in the Slovak educational environment as well as the assessment on its implementation through the case study in 2013.

1.2 Adaptation of the ICT-in-IBSE course into the Slovak context and research questions

In Slovakia, there is a systematic approach to continuous education of in-service teachers. There are a number of accredited teacher-training courses offered by universities or educational institutions for teachers to enroll. After successful completion of the course teachers get credits for their professional development. Gaining a certain number of credits results in promotion in the teacher's career, so teachers are quite motivated to educate themselves. In addition, Slovak science teachers are also assisted to apply for their own projects (prepared by the school itself), aimed at innovation of science teaching. These projects can also involve participation in the teacher-training courses (e.g. ICT-in-IBSE course or IBSE course). Since these courses are not free of charge, teachers need to plan some money in order to participate in such courses. Together with purchasing ICT hardware and software, teachers might also need to develop related lesson materials on the basis of IBSE, enhanced with ICT. Our case study took place in the context of an accredited course, named "*Active learning in computer-based science laboratory*" at Pavol Jozef Šafárik University in Košice for 39 in-service physics, chemistry and biology teachers from lower and upper secondary schools. The course aimed for teachers' knowledge and skills to use the Coach tools and creating students' learning activities which are enhanced by these Coach tools within the IBSE framework.

The participating teachers' experience varied between 1 and 32 years of teaching; the average was about 19 years. Before the course, there were a number of participants with no experience with a certain tool. 72%, 54%, and 41% of all participants were **not at all familiar** with modeling, video measurement, and data

logging, respectively. Chemistry and biology teachers were not reasonably educated in this field. However, there were some physics teachers who had considerable experience with one or two particular tools. The teachers' theoretical knowledge about the intentions of IBSE and about the use of ICT for science education was good. However, many teachers lacked experience of integrating and implementing ICT in the classroom. This statement was even more true for those participating teachers who graduated a long time ago.

Utilizing the ESTABLISH support materials and applying the blended set-up, we developed a course scenario to support this heterogeneous group of Slovak teachers to get certain levels of competency with regard to integration of ICT into IBSE about which most of them did not have much practical knowledge beforehand. Through data collection from the implementation of the course, we investigated the answers to the following questions:

- To what extent was the course implemented as intended?
- To what extent did the course have effects on the teachers as expected?
- What were the problems that the teachers came across in learning how to use the ICT tools?

2. Methods

2.1 Teachers' learning scenario

The participating teachers were divided into two parallel groups in such a way that in each group, heterogeneity regarding the teachers' experience with ICT tools was minimized.

- *Group 1*: 19 physics teachers who were moderately familiar with Coach data logging and video measurement, but just slightly familiar with the modeling tool beforehand,
- *Group 2*: 13 physics teachers, 3 biology teachers, and 4 chemistry teachers who had no or very little experience with all of these Coach tools.

There was remarkable difference between Group 1 and Group 2 regarding the experience with the Coach tools, but no difference in the average number of teaching years. The two groups followed the same scenario (Table 1) which was scheduled for 20 hours of 4 life sessions at the university and for 10 hours of home assignments plus a final assignment with presentation.

Table 14. Teachers' learning scenario for the two parallel groups

Sessions	Group 1	Group 2	Main activities
1. Data logging (a day)	March 28	April 2	<ul style="list-style-type: none"> • Introductory presentation about data logging with Coach • Practicing basic and tutorial data-logging activities • Introductory presentation about data processing & analysis, and practicing data processing & analysis activities.
<i>Home assignment 1</i>			
2. Video measurement (a half day)	April 15	April 16	<ul style="list-style-type: none"> • Introductory presentation about video measurement with Coach • Practicing basic, tutorial & subject video-measurement activities
<i>Home assignment 2</i>			
3. Modeling (a half day)	April 30	April 29	<ul style="list-style-type: none"> • Introductory presentation about modeling with Coach • Practicing basic, tutorial & subject modeling activities
<i>Home assignment 3</i>			
4. Implementation of ICT into teaching (a half day)	May 10	May 9	<ul style="list-style-type: none"> • Introductory presentation about the use of ICT in IBSE • Presenting and discussing sample activities in interactive demonstration, guided discovery, guided inquiry, bounded inquiry, and open inquiry • Discussion on implementation of ICT-IBSE activities in the class
<i>Final assignment with presentation</i>			

In the first three sessions, the teacher trainer introduced basic concepts of the Coach tools (Figure 1a) and helped the teachers with the Coach activities from basic to advanced levels in practical exercises (Figure 1b).

There were enough computers, so the teachers could study Coach video measurement and modeling activities individually. However, for learning how to use the Coach data logging with interface and sensors, they had to practice in groups of three or four. After each session, the teachers got a home assignment about creating a new activity that required a certain level of skills in manipulating the particular Coach tool. At the beginning of the following session, issues of the home assignment were shortly discussed. In Session 4, the teacher trainer introduced the use of ICT in IBSE. The teachers worked in the students' role carrying out exemplary activities at different inquiry levels with the Coach tools, and then discussed about the application of ICT in each example.

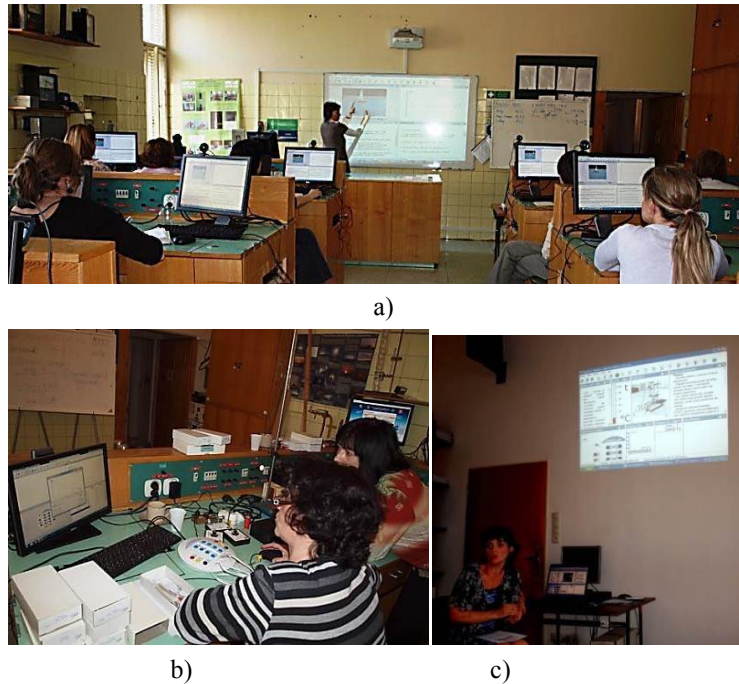

Figure 1. Teachers' learning activities

The course ended with a final assignment with presentation (Figure 1c) in front of a three-member committee. To prepare for the assignment with presentation, the in-service teacher had to develop a lesson plan aimed at a certain level of IBSE following the structure used in ESTABLISH teaching and learning units involving activity title, learning aims, teaching materials, suggestions for use, possible questions. The essence of the teaching materials was a Coach activity that each teacher was expected to develop on her/his own, using data logging, video measurement, or modeling or their combination (with activity descriptions and student assignments). The outputs of each teacher (i.e. a COACH activity with exemplary results complemented with the inquiry-based ICT-integrated lesson plan) were collected before the assignment with presentation itself.

2.2 Assessment instruments

During the case study, we designed and used a variety of research methods to collect data on teachers' learning process and outcomes. The use of multiple methods enables us to validate data through triangulation (Denscombe, 2010). Findings from one method can be compared and contrasted with the outcomes from another. Following this approach, we designed and used the following assessment instruments:

- Q1 - *Pre-course questionnaire*: an online pre-course questionnaire collected information about the teachers' background related to the course contents. It was administered before the first session of the course.
- Q2 - *Post-course questionnaire*: an online post-course questionnaire administered a few days after the session 4. It obtained information about teachers' knowledge, experience, and attitude towards the course contents as well as about their evaluation of the course.
- O1 - *Observation of life sessions*: we observed the teachers' learning process to compare it to the intended program and to find out the teachers' learning problems.

- D1 - *Coach activities*: the teachers had to upload their own Coach activities to the Moodle platform involving home assignments and the final assignment with presentation. Through these Coach files, we examined the teachers' skills at manipulating the particular Coach tool.
- D2 - *Lesson plans*: Through lesson plans that the teachers submitted for the final assignment with presentation, we assessed their skills in designing an inquiry lesson with ICT integration.
- D3 - *Final assignment with presentation results*: judgments of the committee about the teachers' lesson plans with related Coach activities in the assignment with presentation provided us extra information on the teachers' learning outcomes.

(The labels about data sources such as Q2, O1, D3 etc. are referred from the following texts)

Data from various independent sources, i.e. questionnaires (Q1, Q2), observation (O1), documents (D1, D2, D3) was in line with each other. This allows us to formulate the following assessments about the implementation of the course.

3 Results

3.1 To what extent the course was implemented as intended

The course went smoothly as almost all contents intended for the life sessions were covered (O1), and the majority of the teachers managed to accomplish the home assignments and the final assignment with presentation. Many teachers appreciated the good organization of life sessions, followed by self-training on particular Coach tools by which they could work on their own time and pace with support materials on the online platform (Q2).

a) About teachers' learning in the life sessions

The beginning of the first three sessions was always optimistic, even for non-experienced teachers, as the teachers were interested in the introduction and demonstration of the Coach tools, and they embarked on Coach basic activities seriously and fluently. Next, the teacher trainer carried out the tutorial activities together with the teachers and illustrated the manipulations using an overhead projector, so everybody followed and checked what she/he had done (O1). The teachers were expected to go through all given Coach activities to be able to master advanced skills of manipulating a particular Coach tool at the end of each session. However, this expectation turned out to be over-optimistic. It took much time for the teacher trainer to present and demonstrate all concepts and possibilities associated with a particular Coach tool (O1). There were some teachers with very little experience with ICT tools, even missing basic computer skills. This made the hands-on process (following step-by-step instructions of the teacher trainer) slower than intended (O1). For instance, regarding Coach modeling, the teacher trainer had to explain the procedure in detail very slowly, i.e. what are a state variable, an auxiliary variable, an independent variable, and a constant; the flow, connection icons, and other settings.

Teachers complained of too much new information to follow and remember in a long meeting. Furthermore, it was hard for 19 or 20 teachers (in each group) to follow only one learning path at the same pace, including a lot of instruction about technical and conceptual details. In addition, some teachers argued that they needed extra time for learning to use a particular tool to master such a level that they could apply the tool in the classroom (D3, O1). Therefore, teachers suggested less time for plenary introduction plus demonstration and desired more time to practice Coach activities with close supervision, especially the Coach subject activities (Figure 2). This suggestion is in line with a conclusion in Thurston et al., 1997, "Hands-on practice is more critical than theory and demonstration in a technology-based training course".

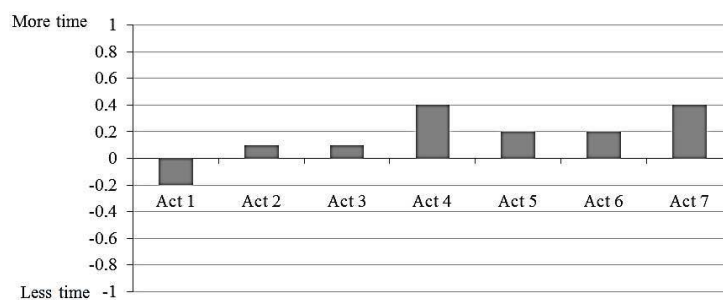

The ratings: "less", "unchanged", or "more" time for each activity correspond to the weights, -1, 0, or 1 (Q2)

Act 1: Plenary introduction and demonstration of the Act 5: Plenary discussion on home assignments

	ICT tools	
Act 2:	Practicing simple activities in groups.	Act 6: Plenary discussion on implementation of ICT in IBSE
Act 3:	Practicing tutorial activities following step-by-step instruction	Act 7: Discussing about inquiry activities enhanced by ICT tools aimed at different levels of inquiry
Act 4:	Practicing subject activities in groups.	

Figure 2. The teachers' opinions about adjustment of time allocated for each activity in the course sessions

b) About the teachers' learning at distance through assignments

The teachers' self-reports (Q2) showed that they spent an average of 2.6, 3.5, and 3.6 (hours) for the three home assignments on creating new Coach data logging, video measurement, and modeling activities, respectively. 4.6 hours on average were needed for the final assignment with presentation. The common problem to almost all teachers was time constraint for home assignments because of daily demanding tasks in their own schools (Q2). A total of 14.3 hours spent for individual work (more than the intended 10 hours) proved that the teachers invested a lot of efforts on these learning activities outside the life sessions. In addition, 25 teachers (out of 39) already tried out the given Coach activities or their own ones with their students, although it was not compulsory. They implemented a few different try-outs with Coach video measurements or measuring with sensors which could be loaned from the course (but none of them tried out the Coach modeling). The teachers evaluated that timely help from the teacher trainer (3.8) was the most influential factor on *teachers' learning* in distance (Q2), followed by the online platform (3.7), clear assignments including a strict deadline (3.7), and awareness of benefits of carrying out assignments (3.6) (5-point scale, 1 = not at all influential, 5 = extremely influential).

Teachers reported that the online platform provided an easy-access resource of support materials and enabled simple upload of home assignments. Support materials were very useful, especially the Coach activities at three levels (Q2) which were self-explanatory and convenient to use at home or at school. However, the maximum upload size to Moodle (8 MB) was small. This sometimes caused troubles as teachers tried to submit large files of Coach video measurement.

3.2 To what extent the course had effects on the teachers as expected

a) About the teachers' learning to use Coach tools

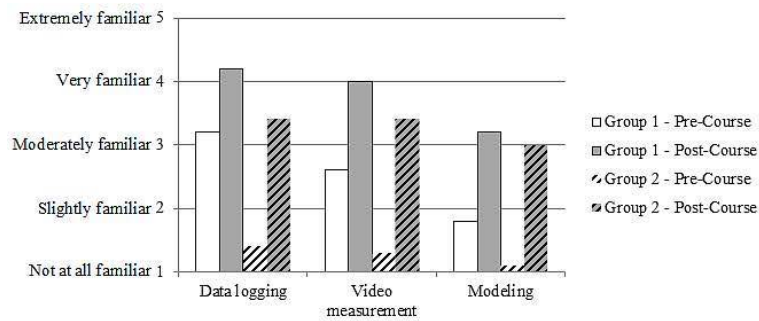

Figure 3. Level of teachers' familiarity to each Coach tool

Responses from pre- and post-course questionnaires (Q1, Q2) showed that the teachers' familiarity with the Coach tools increased significantly, especially for the less-experienced group (group 2) (Figure 3). The teachers were much more confident in manipulating the particular Coach tools (Q1, Q2) (Table 2). After the course, the group-1 teachers were very familiar with data logging and video measurement. Starting as non-experienced Coach users, the group-2 teachers finished the course at just a moderate level of familiarity of all the tools. Also with regard to particular manipulations with each Coach tool, teachers from the group 2 were less confident.

Learning Coach modeling was demanding and time-consuming to both groups as their familiarity and confidence with the modeling tool was remarkably lower than with other Coach tools. Some teachers seemed not to understand the principle of dynamical modeling even after the course. They sounded not confident at all to teach with modeling (D3). After the course, just a few teachers were confident to make a small change to a given model or develop a computational graphical model. This was in line with the teachers' opinions

about whether students can learn modeling in secondary schools. They assumed that students could use, explore, and make a small change to a given model with moderate help from the teacher, but to develop a new graphical model, students will need significant support (Q2).

Table 15. Confidence levels to manipulation skills of particular tools (5 point scale, 1 = not at all confident, 5 = extremely confident)

Manipulation skills	Group 1		Group 2	
	Pre-course	Post-course	Pre-course	Post-course
Data logging				
Connecting sensors to an interface, connecting an interface to a computer	3.3	4.6	1.3	3.8
Setting particular sensor connection in the software	2.8	4.3	1.2	3.6
Setting time-based measurement	2.7	4.1	1.2	3.6
Setting event-based measurement	2.4	4.0	1.2	3.4
Setting a measurement based on a trigger event	2.3	3.8	1.1	3.3
Determining the calibration factors of a sensor	1.8	3.2	1.1	3.1
Video measurement				
Making scale settings	2.0	4.4	1.2	3.7
Specifying features of the co-ordinate system	2.3	4.4	1.2	3.8
Setting time calibration for video	1.8	4.3	1.1	3.5
Performing perspective correction	1.3	3.6	1.1	3.1
Correcting video points by dragging wrong measured points to the correct position	1.5	3.6	1.1	3.1
Setting point tracking by which the measurement is performed automatically through the selected frames according to the given settings	1.8	3.9	1.1	3.4
Modeling				
Using a given model to understand a phenomenon	2.1	4.2	1.2	3.7
Exploring to gain insight into a given model	1.8	3.9	1.2	3.4
Making a small change to a given model	1.6	3.6	1.1	3.4
Developing a computational graphical model	1.5	3.3	1.0	2.9
Developing a computational text model	1.5	2.4	1.1	2.8

During the course, the teachers could create their own Coach activities either connected to data logging, video measurement, or modeling. Levels of these activities varied from very simple to quite advanced (D1, D3). The majority of teachers applied basic ideas and skills, which can be found in exemplary Coach activities. For example,

- *Data logging*: change of temperature during heating, studying motion with a motion sensor;
- *Video measurement*: motion on an incline, free fall, oscillating motions;
- *Modeling*: model of uniform motions.

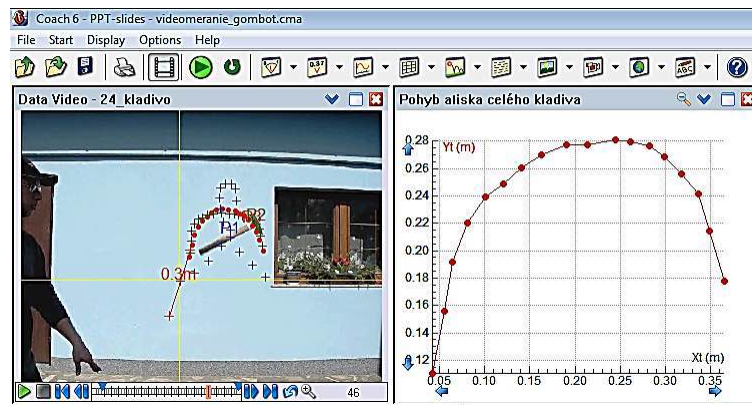

Figure 4. A teacher's Coach video measurement activity on motion of the center of gravity of a hammer

However, there were outstanding outcomes. 4 teachers (all from the group 1) combined modeling with data logging or video measurement to stimulate nice investigations. For instance,

- A model of heating liquid with different electric appliance or a model of phase transition combined with real-time data from the temperature sensor
- A model and a video measurement of a projectile motion or of a braking car in relation to different surfaces

7 teachers showed advanced skills with particular Coach tools, e.g. video measurement on motion of the center of gravity of a hammer (**Figure 4**), model of motion in the presence of resistive forces. Some teachers just used basic skills but introduced nice ideas to apply the Coach tool, e.g. motion of diaphragm during breathing, comparison between a free fall and a horizontal projectile motion. It was not surprising that the group-1 teachers mastered more advanced skills with Coach than those from Group 2 (D1).

b) About the teachers' learning to apply the Coach tools

The in-service teachers were passionate and motivated to learn about the possibilities of the Coach tools (D3). The teachers' self-reports (Q2) presented their awareness and positive attitude of added values of the ICT tools to science teaching. For example:

- Application of the ICT tools might enhance students' motivation towards science, creative thinking, inquiry practice, and enable students to recognize misconceptions. Students will be more active and independent.
- The ICT tools facilitate simple sensor connection; fast, accurate measurement; immediate data presentation in graphs; and convenient, powerful data processing. It saves time for the students' interpretation of the data and meaning making.
- The ICT tools enable to investigate complex phenomena and present data immediately through interactive graphs.

37 in-service teachers (out of 39) could explain in the final assignment with presentation how they integrated their own Coach activities into the inquiry-based lesson plans. The committee judged that the in-service teachers achieved basic skills concerning the use of ICT in science teaching. The lesson plans were aligned only at the first three levels of inquiry: interactive demonstration, guided discovery, or guided inquiry (D3). Determining the appropriate topic and specific inquiry levels for the lesson was the common problem for the teachers. Teachers generally were not optimistic about the successful implementation of a higher level of inquiry activities (bounded and open) in the classroom. Even during the course (Session 4), participants themselves found it difficult to design an experiment and formulate a hypothesis related to a given/proposed problem (O1). They also shared their difficulties in carrying out an inquiry-based lesson, regardless whether they use ICT or not. Consequently, teachers themselves expressed their desire of devoting more time on discussion about inquiry activities enhanced by ICT tools aimed at different levels of inquiry (Figure 2).

Before the final assignment with presentation, 10 teachers already tried out their designed lesson-plans with students (D3) although it was not obligatory. Some teachers got extra motivations as their students were engaged in the ICT activities actively and effectively, beyond their expectations (O1). Those teachers experienced that more detailed instructions for students, smaller working groups, and simpler Coach activities would lead to more effective ICT-IBSE lessons (Q2). After the assignment with presentation, some

teachers continued to implement their lesson plans in the classroom. It sounded quite optimistic as the communication between the course trainers and teachers was still alive even after the course (D3). However, the teachers were quite pessimistic because of the high number of students in the class and changes in the curricula (O1) which led to a limited number of lessons. They considered "Availability of appropriate computer hardware & software" and "Available teaching time" as the two most influential factors (Q1) of the integration of ICT into their teaching practice. They planned to invite colleagues in their own schools to share the experience and to promote the use of ICT. They were very eager to participate in another course for advanced Coach users and looked forward to tailor-made activities by the institute which are ready to use in the classroom (Q2).

3.3 Problems of the teachers in learning how to use the Coach tools

Some particular problems of the teachers' learning to use the Coach tools were observed during the life sessions (O1), examined through the teachers' own Coach activities (D2), or reported via the post-course questionnaire (Q2). Besides basic manipulations with which most of the teachers were familiar, several advanced skills shown in Table 2 (Q1, Q2) were hardly achieved, for example: determining the calibration factors of a sensor, setting a measurement based on a trigger event (data logging); performing perspective correction, correcting video points (video measurement); developing a computational text model (modeling). The CoachLab II+ interface allows automatic sensor detection which is more convenient than older panels in some schools that require choosing the appropriate sensor (Q2). However, teachers still had to learn to deal with some problems:

- It was hard for many teachers to define triggering conditions. The measurement did not start because the triggering conditions were not satisfied.
- The force sensor did not show the proper values that the teachers expected. They had problems in changing the sensor calibration (set zero, set value) or choosing the right range.
- For measurements such as position of a falling object, frequency of sound, alternating current, some teachers could not define appropriate measuring time and frequency.
- In regard to data processing, at the beginning the teachers found difficult to define a new variable that is defined by measured variables and constants. The graph did not show a data curve because the teachers did not set appropriate maximum and minimum values on the axes. Using and manipulating a function fit was problematic to the lower secondary school teachers.

The teachers practiced the given activities on video measurement without major problems, but it turned out to be difficult while they worked on their own activity.

- Problems with perspective correction: after the rectangle was set to the position of the rectangular object in the video, only the selected rectangle and its narrow surroundings were shown. Sometimes a part of motion could not be seen e.g. perspective correction in the video measurement activity of free fall. The teacher had to choose the rectangle which covers the whole track of motion.
- The teachers' video format was not compatible with Coach, or its size was too large. The teachers had to learn to resize their video and convert it to AVI or MPEG formats.
- The chemistry teachers found difficult to get an idea for video measurement for chemistry teaching.
- The teachers planned to use a video from the internet, but could not find real scale and frame rate of the video. The teachers had to learn how to find out this information for time and scale calibration.

Many teachers admitted that they would need more training to be able to create their own model. Problems were connected to developing a new model such as finding an appropriate phenomenon that could be modeled in Coach; defining state variables, flow variables, constants; connecting these variables; and setting a condition – if, then, else. One teacher had experience with Modellus modeling system, but it was not easy for him to work in a different environment.

4 Conclusion and discussion

4.1 Conclusion

The course was implemented quite successfully as the life sessions covered all the intended contents, and majority of the teachers put much effort into the fulfillment of the home assignments and the final assignment with presentation. Division of teachers into two-level groups proved to be appropriate. The main obstacle experienced during the course was that teachers had little experience with the Coach tools. As a

result, the teacher trainer had to explain and instruct concepts and manipulations gradually in detail but always under the time constraint. On the other hand, the teachers complained of too much new information to follow and remember. Consequently, some advanced skills with the Coach tools were not achieved as expected.

The course was implemented quite effectively as almost all teachers gained basic knowledge and skills in using and applying the Coach tools in inquiry lessons. Highlights of the results were:

- The teachers became aware of possibilities and educational benefits of the introduced ICT tools. They were motivated to apply the Coach activities in the classroom.
- The teachers' familiarity, confidence, and skills with the Coach tools increased remarkably.
- 37 teachers (out of 39) could develop their own Coach activities and design their inquiry-based lesson plan enhanced by the introduced ICT tools.

The teachers were quite successful in learning Coach data logging and video measurement, but they still had many problems in learning the modeling tool. To master advanced skills, the teachers needed more time to practice Coach activities or develop their own Coach activities as well as to enrich their background with related knowledge (e.g. principle of dynamical modeling). It is challenging, but still possible as some teachers already achieved advanced skills with the particular Coach tool after the course completion.

The course was successful in applying the blended set-up in which the life sessions were extended appropriately with the home assignments and the final assignment with presentation about applying what they learnt in the life sessions to develop their own Coach activities and lesson plans. Literature on teacher professional development (PD) shows that in order to retain and apply new strategies, skills, and concepts, teachers must receive coaching while applying what they are learning (Guskey, 2000). A training course will only be effective when supplemented by expert or peer coaching and other school-based activities (Fullan, 2007). It is essential to create the proper conditions for teachers to prepare personally work plans and teaching materials for their students (Borghi et al., 2003). A crucial issue was how to keep the teachers on task while they worked in the distance learning mode. In this course, teachers were provided with an online platform where they could access support materials and receive timely feedback from the teacher trainer. The support materials, especially Coach activities at three levels, were very helpful for the teachers' self-study.

4.2 Discussion

The course aimed at the teachers' knowledge and skills in developing lesson plans enhanced by the Coach tools in accordance with the IBSE framework. Implementation of lesson plans in the classroom was not required although it could enable teachers to gain classroom experience with all aspects of integration of ICT into IBSE. Therefore, it is interesting and relevant to carry out a follow-up study of which the research question should be "To what extent can the teachers implement ICT-IBSE lesson plans in the classroom?" The online follow-up questionnaire may be administered to all teachers one or two year after the course. We can also ask them to submit ICT-IBSE lesson plans and related Coach activities which they implemented in the classroom.

The course will be continuously offered to Slovak in-service teachers in the coming years. The new model enables to redistribute the course in order to spend more time and focus on problems that were identified in this case study. Some tentative changes for the next course are suggested as follows:

- More time and support for the teachers' learning of the modeling tool compared to the other Coach tools, instead of dividing time equally
- Less time for presentation and demonstration and more time for the teachers' practice of the Coach activities with supervision and for discussion in groups. This allows the teachers to work on their own learning path with suitable pace.
- Teachers are expected to master advanced skills with each Coach tool when fulfilling the related home assignment instead of at the end of each session. It requires the teacher to work harder in between the meetings with support materials which have been developed for the self-study tasks.
- More time on discussion about implementation of inquiry activities enhanced by ICT tools aimed at different levels of inquiry and principles of an ICT-IBSE lesson plan design.
- Teachers should be encouraged to try out classroom activities. It means they will go through a complete cycle of designing, executing, and evaluating an ICT-IBSE lesson instead of just designing the lesson plan.
- The course is extended to a longer time (40 hours instead of 30 hours), with 5 five-hour life sessions and 15 hours of distant learning instead of the model of 20 present/ 10 distant hours of learning.

Some difficulties in learning a particular Coach tool were encountered and presented in section 3.3. In the life sessions of the next course, we should emphasize on these issues to help the teachers.

It is possible to offer the ICT-in-IBSE course to ESTABLISH project partners or other interested institutions if their institutes have a basic set of the Coach apparatus and software. Translation of the support materials presented in the Moodle environment to more languages is feasible (e.g. Polish and Italian). The Czech partners could already use the Slovak Moodle course as it is now. The purpose of the blended training is to support more teachers for a longer time (not just in workshops). For a long term effect, it is crucial to keep in touch with the teachers and provide them with support, either within face-to-face meetings or through online help. It is necessary to think of critical tasks which suit the local context and come up with how to support further actions, at least from some of the teachers. Maybe that will stimulate others, too.

Acknowledgement

Development and delivery of the course was carried out with the support of the ESTABLISH project (FP7/2007-2013 under grant agreement n° 244749) and Foundation CMA. The course materials were developed by Ewa Kedzierska, Vincent Dorenbos, Ron Vonk, Ton Ellermeijer (CMA), Zuzana Ješková, and Marian Kires (University of Kosice).

References

- Borghi, L., Ambrosis, A., and Mascheretti, P. (2003). Developing relevant teaching strategies during in-service training, *Physics Education*. 38(1), 41-46.
- Denscombe, M. (2010). *The Good Research Guide: for small-scale social research, 4th edition*, Open University Press, ISBN-13: 978 0 335 24140 8 (ebk), Maidenhead, UK.
- Ellermeijer, T. (2013). The Use of ICT in the Framework of Inquiry Based Science Education (IBSE). *Proceedings of the 10th International Conference on Hands-on Science*, Costa, M.F., Dorrio, B.V., Kireš, M. (Eds.), Hands-on Science Network, 3-7.
- Fullan, M.G. (2007). *The new meaning of educational change (4th ed.)*, Teachers College Press, ISBN 978-0807747650, New York, US.
- Guskey, T.R. (2000). *Evaluating professional development*, Corwin Press, ISBN 9780761975618, Thousand Oaks, CA, US.
- Heck, A., Kedzierska, E., and Ellermeijer, T. (2009). Design and implementation of an integrated computer working environment for doing mathematics and science, *Journal of Computers in Mathematics and Science Teaching*. 28 (2), 147–161.
- Kedzierska, E., Ješková, Z., Tran, T.B., Ellermeijer, T., and Kireš, M. (2013). Preparing teachers for the Use of ICT in the Framework of Inquiry Based Science Education (IBSE) – the ESTABLISH Approach, *Proceedings of the 10th International Conference on Hands-on Science*, Costa, M.F., Dorrio, B.V., Kireš, M. (Eds.), Hands-on Science Network, 290-298.
- Rocard, M. et al. (2007). *Science education now: A renewed pedagogy for the future of Europe*, Office for Official Publications of the European Communities, Luxemburg. Retrieved from http://ec.europa.eu/research/science-society/document_library/pdf_06/report-rocard-on-science-education_en.pdf
- Thurston, C.O., Secaras, E.D. and Levin, J.A. (1997). Teaching teleapprenticeships: An innovative model for integrating technology into teacher education, *Journal of Research on Computing in Education*. 29(4), 385-391.
- Tran, T. B., van den Berg, E., Ellermeijer, A. L. and Beishuizen, J. (2014). Development of a pre-service course on integration of ICT into inquiry based science education. *Proceedings of the ICPE-EPEC International Conference on Physics Education*, The International Commission on Physics Education, 629-642. http://www.icpe2013.org/uploads/ICPE-EPEC_2013_ConferenceProceedings.pdf

Affiliation and address information

Zuzana Jeskova
Institute of Physics, Faculty of Science
Pavol Jozef Šafárik University in Košice, Slovakia
Šrobárova 2, 041 80 Košice
Slovak Republic
e-mail: zuzana.jeskova@upjs.sk

iMobile Physics: A Research and Development Project for Teaching and Learning with Smartphones and Tablet PCs as Mobile Experimental Tools

Pascal Klein¹, Jochen Kuhn¹, Andreas Müller²

¹ University of Kaiserslautern, Physics Education, Mail: pklein@physik.uni-kl.de; kuhn@physik.uni-kl.de

² Université de Genève, IUFE, Mail: andreas.mueller@unige.ch

Abstract

New media technology has become increasingly important for our daily lives as well as for technology-enhanced learning. The design and research project iMobile Physics develops mobile experimental tools (METs), using smartphones and tablet PCs to conduct experiments in higher physics education, and investigates affective and cognitive effects triggered by these devices. In this paper, we first provide two examples which illustrate how the technical possibilities of METs can be exploited in physics education. We then relate the educational potential of these possibilities to existing research in science education and present a study which explored the educational effects on first-year physics students. In a quasi-experimental repeated measures design, a treatment group working on learning exercises enriched with METs was compared to a control group working with conventional exercises (with identical content and time on task). Results are reported on self-efficacy, as a specific and important aspect of motivational variables. We show that METs had a positive medium-to-large sized influence ($F=8.60$, $p<0.01^{**}$, Cohen's $d=0.7$) on the perceived self-efficacy of physics students; with the same effect on female and male students. The paper ends with a discussion on some limitations of the presented study, and the outlook regarding the next steps.

Keywords

mobile and personal IT devices, smartphone, tablet PCs, physics education

1. Introduction

The rapid spread and popularity of wireless communication and mobile technologies has a strong influence on our daily lives. A survey conducted in 2013 shows that more than 70% of teenagers and young adults in the US own a smartphone. Similarly, the number of tablet PC users in the US is predicted to increase to more than 80% of the teenage and adult population by 2015¹. These numbers indicate a world-wide trend and provide quantitative evidence of the phenomenon (of which many readers are intuitively well aware) that these devices have become part of everyday life, in particular for the young generation. Moreover, wireless communication and mobile technologies provide opportunities for new learning approaches and influence the design of learning activities. With their high degree of mobility and portability, mobile devices can be used to access digital content in real-world situations indoors and outdoors, and therefore enable us to connect abstract concepts to real-world contexts for the purpose of learning (Lave & Wenger, 1991). While the significance of mobile learning approaches is rapidly increasing worldwide, especially in the Asia-Pacific area, little attention has been paid to exploiting the sensor technologies of smartphones for education in general and for physics in particular. In the iMobile Physics project, we are closing this gap by developing innovative physics experiments with mobile devices in which their internal sensors are used to gather experimental data. The experiments are then conducted in research-based learning sequences.

The paper is organized as follows: first, we will argue that our approach offers unique possibilities of engaging in scientific inquiry in formal and informal ubiquitous learning settings and support this statement with two illustrative examples. Next, we will relate the educational potential of these possibilities to existing research in science education. Building on this background, we will discuss a pilot study which aims to investigate the effects of working with mobile devices on students' motivation in university physics; in the present paper, we will focus on self-concept as a specific and important aspect of motivational variables.

¹ <http://www.statista.com/statistics/199761/forecast-of-tablet-pc-users-in-the-united-states-from-2010-to-2015/>; access 28/10/2014

Finally, we will discuss some methodological and practical limitations of the present study and provide an outlook on the next steps which aim to overcome these limitations.

2. Theoretical background

2.1 The iMobile Physics project: Two examples

Indeed, there is a diverse range of applications for these devices as mobile experimental tools (MET) used to gather data indoors and outdoors, mainly because they are equipped with numerous internal sensors. For example, they have a built-in microphone and camera, a 3D-acceleration sensor, a magnetic field sensor and a GPS receiver. The data captured by these sensors can be retrieved using additional “on-board” programs (“apps”), making it possible to conduct both qualitative and quantitative experiments with the devices (e.g. Klein, Hirth, Gröber, Kuhn & Müller, 2014). They can therefore be seen as small, mobile measuring laboratories, which can replace complex sets of test instruments. In addition, the learners are familiar with them, as they use them on a daily basis, and are therefore used to operating them.

In recent years, various articles have been published about the broad and diverse range of examples of smartphone experiments in different journals, giving rise to discussions about the subject. Kuhn (2014) gives a synopsis of a variety of examples. The iMobile Physics project focuses on developing innovative experiments using smartphones and tablet PCs in physics education, on implementing them in research-based learning sequences and on studying the effect of these concepts on learning and motivation in physics education from secondary level I to university level. An illustrative example of the use of smartphones to explore the physics of everyday phenomena is provided by the following observation made during an elevator ride.

2.1.1 Elevator Ride: Accelerometer Analysis of Oscillation Frequency

When using a cable-driven elevator, you might have noticed that a sudden jolt, perhaps caused by someone jumping vertically in the elevator (caution!), causes the elevator cabin to oscillate, with the noteworthy feature that the period of oscillation decreases at higher levels. The reason for this is that, in simplified terms, a cable-driven elevator can be seen as a spring pendulum. The elevator cable corresponds to the pendulum spring (spring constant k) and the elevator cage corresponds to the pendulum body (mass M). The duration of period T is thus determined by the equation $T = 2\pi \sqrt{M/k}$ ². The spring constant itself is, in turn, inversely proportional to the length L and directly proportional to the modulus of elasticity E and the cross-section A of the elevator cable. Inserting this relationship into the above relation, one obtains

$$T = 2\pi \sqrt{\frac{M \cdot L}{E \cdot A}}, \text{ i.e. } T^2 : L.$$

In order to investigate the validity of this relationship, a smartphone or a tablet PC is placed on the floor or the wall of the elevator (see Fig. 1). While the elevator is stationary, the vertical component of acceleration (perpendicular to the floor) is selected using an appropriate app² and the measurement is started. When a person jumps one time in the elevator, he or she causes it to start oscillating, which is then recorded using the app.

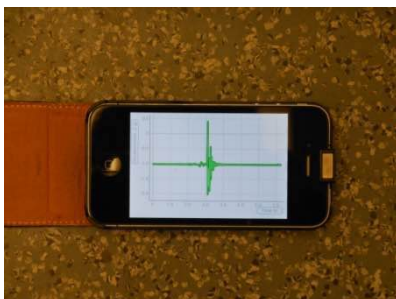

Figure 1. Smartphone on the floor of the elevator (here: iPhone with the "SPARKvue" app)



Figure 2. Building with a cable-driven elevator

² SPARKvue by PASCO (iOS and Android), online: <http://www.pasco.com/sparkvue/> (06/2014).

The period of oscillation is determined from the oscillation curve and the procedure is repeated on every storey of the high-rise building (see Fig. 2). In order to see the behaviour predicted above, the experimenter must select a building with a sufficiently high number of storeys. With the smartphone measurement of T and an estimation of the cable length L obtained by adding together the heights of the individual storeys plus the remaining height between the top floor and the building's roof (where the elevator motor is located), the relation of the cable length and the square of the duration of periods can be plotted. Fig. 3. shows how the data approximately agree with the $T^2 \propto L$ relationship, which in view of the simplicity of the underlying model can be regarded as satisfactory (determination coefficient $R^2 = 0.94$).

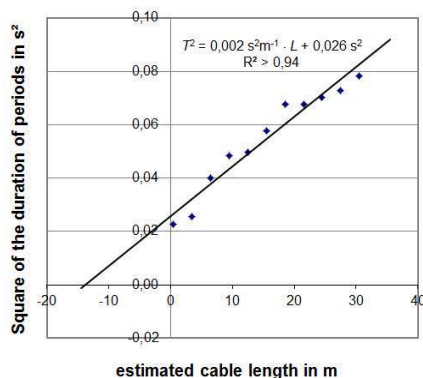

Figure 3. Graphical depiction of the measured values

2.1.2 Skateboard Ride: Mobile video-based motion analysis (mVBMA)

If equipped with a camera, METs can also be used to record and analyze videos of physical motion processes. The principle of video-based motion analysis is not new (Beichner 1996), but mobile devices add new techniques to this method that allow students to play a more proactive role in problem-solving processes (Klein, Gröber, Kuhn & Müller 2014). The authors describe a simple but engaging experiment. The motion of a ball thrown vertically from a moving skateboard is recorded and analysed with a tablet computer. A video analysis application³ extracts measurement data from the video by point-tracking. This two-dimensional displacement-time data can subsequently be plotted or processed to derive other physical quantities such as velocities, accelerations, etc. (Fig.4). The implementation of this use of METs in the learning setting of university courses on experimental physics is the subject of the empirical study presented in Sect. 3.

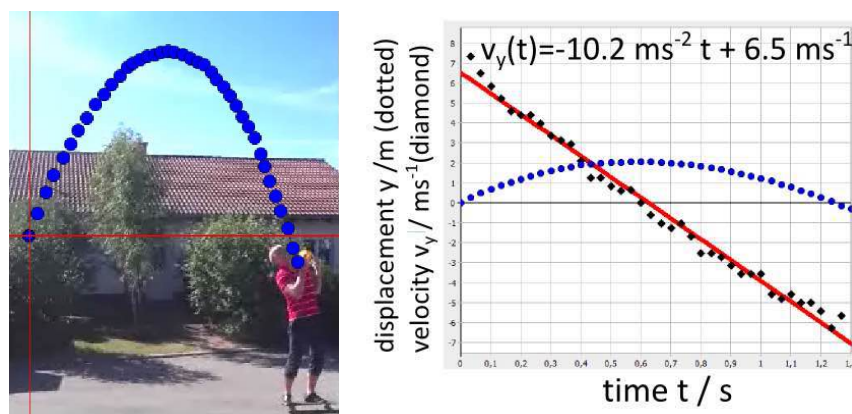

Figure 4. (Left) video-based motion analysis: point tracking of a ball thrown from a moving skateboard. The blue circles correspond to the position of the ball in each video frame. The reference system is highlighted in red colour; (Right) kinematic graphs from motion data: gravitational acceleration can be determined very accurately by the slope of the vertical velocity regression line to $g = -10.2 \text{ ms}^{-2}$

2.2 Self-Efficacy Expectation (SEE) in science education

³ VideoAnalysis (iOS), online: <http://www.vernier.com/products/books/pva/>; VideoAnalysis (Android), online: <http://www.physik.uni-kl.de/kuhn/forschung/vip-video-based-problems/video-analysis-app/> (10/2014).

As the introduction and the preceding examples show, smartphones and tablet computers offer unique opportunities for establishing a double link to the real world of learners: first, the device itself represents a genuine link to their world as it is familiar and widespread nowadays; second, the settings (situations) also constitute a link as mobile devices can be used in scientific inquiries of many kinds due to their mobility and flexibility. In order to establish whether this potential, provided by technological progress, really leads to benefits for science teaching and learning, one has to draw on educational research (both theoretical and empirical). Indeed, the strong real-world link is a core feature of “context-based science education”, which has a long-standing tradition and is considered to be a highly promising approach in science education (Fensham, 2009; Bennett, Lubben & Hogarth, 2007; Parchmann et al., 2006; Weddington, 2005). Context-based science education (CBSE) is currently broadly understood as “using concepts and process skills in real-life contexts that are relevant to students from diverse backgrounds” (Glynn & Koballa, 2005). Making science issues relevant to students and the social group they live in (peers and relatives) counters the widespread perception of physics as being dry, impersonal and irrelevant. We can therefore assume that it has positive effects on their interest in both science and technology, their self-efficacy and their learning. Self-efficacy is understood here as confidence in one’s own abilities to handle tasks effectively and overcome difficulties (OECD, 2007); as this is a personal perception or expectation, the more precise term self-efficacy expectation (SEE) is currently used.

This understanding of context-based science education in general together with new mobile and flexible technologies, in particular, seems to be in line with the very spirit of context-aware ubiquitous learning approaches (see 2.1). Several systematic reviews have established considerable effects on science- and technology-related attitudes and understanding, with effect sizes up to $d = 0.67$ and $d = 1.52$, respectively (Taasobshirazi & Carr, 2008; Bennett, Lubben and Hogarth, 2007). In the present paper, we focus on domain-specific self-efficacy expectation as an important motivational variable for three reasons. First, SEE has been shown to have a strong influence on the preferences of pupils for school disciplines and for professional careers in the area of science and technology – an important issue for science educators. As Albert Bandura, a pioneer in the field, says: “Children’s perceived efficacy rather than their actual academic achievement is the key determinant of their perceived occupational self-efficacy and preferred choice or work life” (Bandura, Barbaranelli, Carprara & Pastorelli, 2001). Increasing support from empirical studies validates this influence of SEE on career-relevant behaviour. For example, effect sizes of 0.38 and 0.34 for the relation of SEE to measures of academic performance and persistence, respectively, were found (Multon, Brown & Lent, 1991). As a result, the SEE-career choice link has become a well-established element of developmental and personality psychology, as evidenced by the reference work of Salkind (2006), for example, in which it is stated that “SE [self-efficacy; authors] beliefs influence career-entry indexes (e.g. range of career options, persistence in education, career indecision)” and - “gender differences in SE often explain the male-female differences in occupational choices”. Of course, the latter statement is of particular interest for the field of science and technology, and the studies presented below consequently explored possible gender effects. Second, SEE has been shown to have a strong influence on learning in a given domain (which, in turn, is of course an important basis for career choices); quantitatively, Hattie (2009) showed an average effect size of $d = 0.43$ across 324 studies, with individual results as high as $d = 0.76$. For the first and second effect just described, Hattie also gave a plausible explanation: “In particular, a sense of confidence is a most powerful precursor and outcome of schooling. It is particularly powerful in the face of adversity—when things do not go right, or when errors are made. Having high levels of confidence—“can do”, “want to do”—can assist in getting through many roadblocks”.

Third, previous research by Kuhn and Vogt (2015) showed that the specific CBSE approach of this study using mobile devices as experimental tools can indeed foster discipline-related SEE. In a quasi-experimental pilot study on the topic of acoustics in secondary level I, Kuhn & Vogt identified a significant positive influence on SEE ($d = 0.62$). Moreover, there was no influence of gender; that is, both women’s and men’s SEE was supported by this approach. The purpose of the empirical part of the present work is to replicate and refine this finding of Kuhn & Vogt for a different topic and age group, as described in the next section.

3. Empirical Study: Impact of METs on physics students’ academic self-efficacy perception

3.1 Study Framework and Hypotheses

Within the iMobile Physics project, this study focuses on the use and impact of METs in the educational setting of introductory courses on experimental physics. In many universities, these courses are delivered as a lecture accompanied by a mandatory tutorial, in which students have to solve physics exercises dealing

with the lecture content. The results of these exercises often make up part of the students' grades. On the one hand, these are considered to be foundation courses for university studies in physics; on the other hand this format has some well-known limitations. While the course is on experimental physics, and the lectures usually show experiments, the tutorials (and exercises to be solved during the tutorials) are almost exclusively paper-and-pencil based and are rarely linked to concrete data and experiments. Operating with METs as a measurement and analysis instrument offers the opportunity to closely link the theoretical background and truly experimental tasks; see examples in Section 2 or as presented in Klein, Kuhn, Müller & Gröber (2015) or Gröber, Klein & Kuhn (2014). This inherent feature of the exercises provides prompt feedback about learning and understanding. As a result, SEE should increase as students can value their abilities and skills (Craven, Marsh & Debus, 1991; Preim & Dachselt, 2010). Students can record and analyse their own data concerning real physical phenomena nearly independently of time and location, and they do not have to rely on special laboratory equipment. We consider this to be an example of ubiquitous and contextual learning, where the learning situation comes close to the working situation of a “real experimenter”, using his own device, data and analysis. Based on the theoretical background explained above, we hypothesize that the contextualisation provided for experimental physics courses by MET-based exercises will lead to improved learning and motivation in general (treated in a forthcoming study) and to improved self-concept in particular (focus of this study, for the reasons given in Sect. 2.2).

3.2 Design and Instructional Material

Specifically, this study deals with a physics course on mechanics and uses mobile video-based motion analysis (mVBMA) presented in Sect. 2.2 (note that it is the mobile aspect which is the new feature of METs, while video analysis of motion as such is well known). In our approach, we combine the traditional course format, that is, the theoretical background (in the lecture) and exercises (in the tutorial), with a new type of exercises based on mVBMA, in which students use their own mobile devices to gather and analyse data from real video experiments (see Fig. 4). We refer to these exercises as mVBMA exercises and compare them to traditional exercises, which are pen-and-paper based and require no experimentation. The text box shows an example referring to the skateboard ride above [the differences between the traditional exercise and the mVBMA exercise are in italics (= mVBMA only) and boldface (= traditional only)].

Consider a person launching a ball vertically (y -direction, launch speed v_L) while standing on a skateboard moving horizontally (x -direction, speed v_S). The person catches the ball again, continuing the ride.

- a) *Video record the situation.* Explain this observation by referring to physical principles.
- b) Derive the trajectories $x(t)$, $y(t)$ both for the skateboard and the ball. What trajectory does the person standing on the skateboard follow? *Prove your claims with measurement data.*
- c) Give formulas for the time, height and length of flight and estimate their values using **reasonable approximations** (*video data*) for above parameters v_L , v_S .
- d) **Argue that this experiment still works when moving down an inclined road.**

The study was carried out with a quasi-experimental repeated-measures design during the summer and winter term of 2013/14 (two cohorts). The intervention took place in the tutorials of the classical mechanics course, which students have to attend parallel to the lectures. Table 1 shows the study design with two measurement points. During the instruction phase, the mVBMA learning groups (treatment groups, TG) and traditional learning groups (control groups, CG) were instructed for four weeks using exercises with identical content. The control group students solved traditional exercises which had been used in lectures in recent years covering common subjects of mechanics (e.g. kinematics, dynamics, angular momentum, fluid mechanics and oscillations). The treatment group students solved equivalent exercises (same context, same content) but were supported with hands-on material for conducting an experiment concerning the problem in two out of three exercises of each sheet. The experimental part of the exercises required the TG students to measure quantities (e.g. distances, angles) in a video, to derive qualitative and quantitative statements, to generate motion graphs or to visualize the vector quantities of the experiment using the video data. In each mVBMA task, students had to compare their predictions (theory) with the experimental results. In order to keep time on task constant in both groups, the CG students had to solve some additional theoretical exercises (e.g. further calculations), and this was checked by asking students to report time on task.

Table 1. study plan of the empirical investigation.

lecture week	Control Group (CG), N=30	Treatment Group (TG), N=23
1	Pre-test: covariates and academic self-concept	
2	traditional instruction: weekly pen-and-paper exercises	mobile video-based motion analysis instruction: equivalent exercises and experimental tasks
3		
4		
5		
6	post-test: academic self-concept semi-structured student interviews (not reported here)	

Domain-specific self-efficacy was tested before and after the treatment using an adapted form of Kuhn's MAI questionnaire (2010); see details below. Additionally, the following covariates/cofactors were taken into account: final gymnasium grade (fGG, gymnasium is the German secondary school track for high achievers); average achievement in physics (AP); average achievement in mathematics (AM); gender.

3.3 Sample, measures and method of analysis

The sample consisted of $N = 53$ students enrolled in academic year 2013/14. They were enrolled on the Physics Diploma and Bachelor of Science Degree ($N = 36$), Biophysics Degree ($N=10$) and Bachelor of Education Degree ($N=7$). The students were randomly assigned to the TG and CG with the same tutorial instructor, who did not participate in the study and was instructed not to favour any group. Assessment took place in the weekly tutorials.

Measures: Domain-specific self-efficacy expectation was measured with an adapted form of the SEE subscale of Kuhn's MAI questionnaire, with eight items on a 6-point Likert-type scale. Sample items are given in Table 2. The reliability of the scale is sufficient for the sample of this study (Cronbach's $\alpha = 0.82$). Total time on task was estimated by the students themselves.

Table 2. Sample items of the SEE instrument

I understood the exercises.
I always succeeded in solving the exercises.
I was able to concentrate on the exercises
I performed well on the exercises.

Before treatment, students stated their final gymnasium grade (fGG), their average achievement in mathematics (AM) and in physics (AP) as last grades awarded at gymnasium.

Method of analysis: The SEE was analysed with an ANCOVA using a repeated-measures design with treatment groups as between-subject factor and time of measurement as a within factor; fGG, AM and AP were used as covariates and gender was used as a cofactor. Total time on task and the covariates were compared between the groups using a two-tailed t-test.

3.4 Results

Table 3 shows the descriptive data from the assessments. We found no differences in total time on task ($t = 0.81$, $df = 42$, $p = 0.42$)⁴. The groups did not differ significantly with respect to the covariates fGG, AM and AP ($t < 0.88$, $df = 52$, $p > 0.38$). The ANCOVA revealed a medium-to-large sized effect ($F = 8.60$, $p < 0.01$, $d = 0.7$) of the treatment on the development of SEE. The covariates, including gender, did not influence this result significantly.

⁴ A t-test is used to determine if two sets of data are significantly different from each other by calculating a test-statistic t (basically a signal-noise-ratio) and taking the degrees of freedom (df) into account (df depends on sample size). Once a t value is determined, a p-value can be found using a table of values from t-distribution. If the calculated p-value is below the threshold chosen for statistical significance (usually the 0.05, 0.01 or 0.001 level), then the null hypothesis (data sets are not statistically different from each other) is rejected in favor of the alternative hypothesis. ANCOVA is a more general approach taking covariates (and possibly more than 2 groups) into account. Instead of a t-value, ANCOVA produces a F-value. The effect size d is defined as the difference between two means divided by a standard deviation for the data. As it is independent of sample size, it is the measure of practical importance.

Table 3. The average scores of dependent variables and covariates with standard deviations in parentheses.

Variables	CG (N = 23) M (SD)	TG (N = 30) M (SD)
Academic self-concept pretest ^a	67.5 (9.3)	65.2 (10.3)
Academic self-concept posttest	61.6 (13.4)	70.0 (11.7)
Final gymnasium grade (fGG) ^b	2.1 (0.8)	2.1 (0.7)
Average achievement in mathematics (AM) ^c	12.0 (2.2)	11.7 (2.0)
Average achievement in physics (AP) ^c	11.9 (2.7)	11.1 (3.4)
Total time on task ^d	6.5 (4.1)	5.5 (3.1)

^a score from 0 (lowest SEE) to 100 (highest SEE); ^b represented as grade with range from 1 (very good) to 6 (unsatisfactory); ^c represented as points with range from 1 (unsatisfactory) to 15 (very good); ^d reported in hours per week.

4. Discussion and conclusion

This paper presents the iMobile Physics project, which aims to design and empirically investigate the use of mobile IT devices as experimental tools in physics education. Besides the rationale and theoretical framework of the project, it describes a study of a classical mechanics course at university level. The study was carried out with a quasi-experimental repeated-measures design, taking into account a number of control variables and potentially influential cofactors and covariates.

The results show that METs (mobile experimental tools) have a positive influence on perceived self-efficacy (as a sub-dimension of motivation), which is statistically highly significant and of considerable practical importance ($p < 0.01$, $d = 0.7$). It is noteworthy that this positive finding holds for female physics students and male students to the same degree. The present study thus confirms the result of an earlier study (Kuhn & Vogt, 2015) for another topic, and for another target group (university students instead of secondary level II pupils). This result is of interest for science education, as self-efficacy is known to influence successful learning and career choices in the field of science. We will now turn to the constraints and limitations of the approach, and to the implications for both future research and classroom practice.

As presented, the TG and CG differ only with regard to the type of exercises they solve. However, the TG students work with mobile devices and conduct experiments whereas the CG students solve traditional problems. Therefore, it is not possible to determine whether the experiments themselves, the use of mobile devices or possible collaborations between students caused the positive effect on SEE. To investigate the relevance and impact of mobile devices as such, further studies with similar groups have to be conducted. Nevertheless, it seems reasonable to start by contrasting the mVBMA tasks to the well-established method that has been used in university physics tutorials for decades (pen-and-paper exercises) – especially with regard to their practicability in conventional teaching and learning settings at university level.

Concerning classroom practice in schools, it is a priori desirable that students conduct experiments with their own devices. However, at the moment we cannot assume that every student has his or her own smartphone, and we would like to avoid introducing social disadvantages. An additional problem with students bringing their own devices into the classroom would be that they would have to use system-specific apps to conduct the experiments; therefore, the teachers would have to be well-versed in using the different apps on different operating systems (e.g. Android vs. iOS). This is an obvious practical constraint, and we recommend that some standard smartphones are purchased for use in physics lessons. The costs would be roughly USD 3000 (for about 15 devices) and that would, for example, be cheaper than the same number of voltmeters for students or than data acquisition systems.

Another limitation of the present study is the specific target group and subject matter considered, as well as the specific outcome variable (SEE). For the latter, an extension of the MET study on the university level is under way which investigates other motivational variables (such as intrinsic interest) as well as learning variables (such as conceptual understanding); moreover, effects on study satisfaction indicators and perceived demand rates will be included. As a next step, research within the iMobile Physics project is currently being extended to other populations (e.g. age groups, school types and educational levels). Moreover, we will study whether an intervention with METs stimulates pupils and students to use their own devices to investigate other physics (science) phenomena they encounter at home or in their daily lives, thus constituting an instance of ubiquitous and contextual learning.

References

- Bandura, A., Barbaranelli, C., Caprara, G.V. and Pastorelli, C. (2001). Self-efficacy beliefs as shapers of children's aspirations and career trajectories. *Child Development* **72** (1), 187-206.
- Beichner, R.J. (1996) The impact of video analysis of motion on graph interpreting skills. *American Journal of Physics* **64** (10), 1272–1277.
- Bennett, J., Lubben, F. and Hogarth, S. (2007). Bringing Science to Life. *Science Education* **91** (3), 347-70
- Craven, R.G., Marsh, H. W. and Debus, R.L. (1991). Effects of internally focused and attributional feedback on enhancement of academic self-concept. *Journal of Educational Psychology* **83** (1), 17-27.
- Fensham, P.J. (2009). Real world contexts in PISA science: Implications for context-based science education. *Journal of Research in Science Teaching* **46** (8), 884-896.
- Glynn, S. and Koballa, T.R. (2005). The contextual teaching and learning approach. In R. E. Yager (Ed.), *Exemplary Science. Best practices in professional Development* (pp. 75-84). Arlington, VA: National Science Teacher Association Press.
- Gröber, S., Klein, P. and Kuhn, J. (2014). Video-based problems in introductory mechanics physics courses. *European Journal of Physics* **35**, 5, 055019
- Hattie, J.A.C. (2009). *Visible learning: A synthesis of over 800 meta-analyses relating to achievement*. London: Routledge.
- Klein, P., Groeber, S., Kuhn, J. and Müller, A. (2014) Video analysis of projectile motion using tablet computers as experimental tool. *Physics Education* **49** (1), 37-41.
- Klein, P., Hirth, M., Gröber, S., Kuhn, J. and Müller, A. (2014). Classical Experiments revisited: Smartphone as Experimental Tools in Acoustics and Optics. *Physics Education* **49** (4), 412-418.
- Klein, P., Kuhn, J., Müller, A. and Gröber, S. (2015). Video analysis exercises in regular introductory mechanics physics courses: Effects of conventional methods and possibilities of mobile devices. In A. Kauertz, H. Ludwig, A. Müller, J. Pretsch and W. Schnotz (Eds.), *Multidisciplinary Research on Teaching and Learning* (pp. 270-288). Basingstoke: Palgrave Macmillan.
- Kuhn, J. (2014). Relevant information about using a mobile phone acceleration sensor in physics experiments. *American Journal of Physics* **82**, 94.
- Kuhn, J. and Vogt, P. (2015). Smartphones and Co. in Physics Education: Effects of Learning with New Media Experimental Tools in Acoustics. In A. Kauertz, H. Ludwig, A. Müller, J. Pretsch and W. Schnotz (Eds.), *Multidisciplinary Research on Teaching and Learning* (pp. 253-269). Basingstoke: Palgrave Macmillan.
- Kuhn, J., Vogt, P. and Müller, A. (2014). Analyzing Elevator Oscillation with the Smartphone Acceleration Sensors. *The Physics Teacher*. **52** (1), 55-56.
- Kuhn, J. (2010). *Authentische Aufgaben im theoretischen Rahmen von Instruktionen- und Lehr-Lern-Forschung: Effektivität und Optimierung von Ankermedien für eine neue Aufgabenkultur im Physikunterricht* [translated as: *Authentic Tasks in the Theoretical Framework of Instruction and Teaching and Learning Research: The Effectiveness and Optimization of Anchor Media for a new Task Culture in Physics Instruction*]. Wiesbaden: Vieweg+Teubner Verlag.
- Lave, J., and Wenger, E. (1991). *Situated learning: Legitimate peripheral participation*. New York, NY: Cambridge University Press.
- Multon, K.D. Brown, S.D. and Lent, R.W. (1991). Relation of self-efficacy beliefs to academic outcomes: A meta-analytic investigation". *Journal of counseling psychology* **38** (1), 30-38.
- OECD (2007), "PISA 2006 science competencies for tomorrow's world", Volume 1: Analysis. (Paris)
- Parchmann, I., Gräsel, C., Baer, A., Nentwig, P., Demuh, R., Ralle, B., and the ChiK Group (2006). Chemie im Kontext: A symbiotic implementation of e context-based teaching and learning approach. *International Journal of Science education* **28** (9), 1041-1062.
- Preim, B. and Dachsel, R. (2010). *Interaktive Systeme [Interactive Systems]*. Berlin, Germany and Heidelberg, Germany: Springer-Verlag.
- Salkind, N.J. (2006). *Encyclopedia of Human Development*, Thousand Oaks, London: Sage Publications.
- Taasoobshirazi, G. and Carr, M. (2008). A Review and Critique of Context-Based Physics Instruction and Assessment. *Educational Research Review* **3** (2), 155-167.

Weddington, D.J. (2005). Context-based learning in science education: a review. In P. Nentwig & D. Waddington (Eds.), *Making it relevant: Context based learning of science*. Münster, New York, München, Berlin: Waxmann.

Affiliation and address information

Pascal Klein
University of Kaiserslautern, Department of Physics, Physics Education
Erwin-Schrödinger-Straße 46,
67663 Kaiserslautern, Germany
pklein@physik.uni-kl.de

What is Light? From Optics to Quantum Physics Through the Sum over Paths Approach

Massimiliano Malgieri, Pasquale Onorato, Anna De Ambrosis

University of Pavia, department of Physics.

Abstract

In this work we propose a learning sequence on the nature of light, starting from wave optics and leading to quantum physics. Feedback from previous in-service teacher courses convinced us that a revision of the traditional approach to wave optics can favour a gradual and effective approach to quantum concepts.

Moving from an established research line on the educational use of the Feynman sum over paths method, we make an effort of clarifying several conceptual and epistemological aspects of quantum theory by presenting modern experiments, mainly from the field of quantum optics, from the point of view of Feynman paths. In addition, we implemented interactive simulations allowing a visualization of Feynman's model in selected physical situations using the widely praised, open source software GeoGebra, and coupled them to a solid experimental base using low-cost equipment and the Tracker software, also open source. We tested our approach in a course for pre-service teachers, obtaining encouraging results.

Keywords

Teaching quantum physics, Feynman paths, interactive simulations, interferometry.

1. Introduction

The history of the answers to the question “what is light?” runs as a fascinating thread intertwined with the history of physics as a whole. During their high school curriculum in science-oriented programs, many students encounter three different models of light, at different level of sophistication: light as a ray (geometrical optics), light as a wave (wave optics) and finally, light as a photon (in introductory quantum physics). Often no attempt is made to connect these models, and to provide a unified picture, and a global answer to the question of the nature of light. However, Feynman's sum over paths approach, which has a consolidated tradition in the teaching of quantum physics (Taylor et al., 1998; Cuppari et al., 1997, de los Angeles Fanaro et al., 2012; Dobson, 2000; Ogborn & Whitehouse, 2000) allows to build a strong connection between the wave phenomenology of light and the properties of the photon; also, it provides a particularly clear explanation of the emergence of geometrical optics in the limit of small wavelengths with respect to other length scales of the system.

With respect to existing proposals, our work tries to address more in depth conceptual and epistemological themes which are peculiar to quantum physics by treating, in the language of Feynman paths, modern interferometry experiments in which non classical features are clearly focused. Themes such as the impossibility to attribute a trajectory to particles, the role of measurement and wave function collapse, the uncertainty principle, the consequences of indistinguishability of identical particles, can be formulated in particularly clear terms when seen from the perspective of the sum over paths approach. Modern interferometry experiments can also serve as a natural introduction to current, information based foundational views, which the language of Feynman paths is particularly suited for expressing. For example, in the sum over paths perspective, “wave particle duality” is simply a consequence of the reduction of possible paths for the system, due to acquired information. With the loss of possible paths, interference is lost, and so is the wave character of the quantum object. Thus the Feynman model allows to provide a verbal explanation (rationalization) of duality, as seen for example in two slit interference.

For the purpose of letting students familiarize with Feynman's model and explore its features in relevant physical settings, we developed interactive simulations using the software GeoGebra, which is widely used and praised in the community of teachers of mathematics and physics (Hohenwarter et al., 2009). GeoGebra offers the possibility of a high level of interactivity and manipulation through the use of sliders and boxes; it allows to build an intuitive connection between two different dynamical representations by seeing them paired in adjacent workspace windows; and finally, permits to save one's work in common open formats.

2. Organization of the sequence

The sequence starts from the phenomenology of wave optics, as observed in the classical experiments of interference and diffraction. Experiments are performed and discussed using Tracker as a tool to produce a quantitative analysis of interference fringes. The method of paths and phasors is introduced as a convenient way of representing wave phenomena, and its results, derived from simulations and direct calculations, are compared to experiment.

The next step is the discussion of experiments leading to the necessity of a photon model: photoelectric effect, two slits interference with individual photons, and the Grangier experiment on photon indivisibility. Each experiment is discussed in its own significance, and the model of the photon following all possible paths from source to detector is derived as a logical consequence.

A central part of the sequence is devoted to discussing conceptual and epistemological themes through the analysis of modern quantum optics experiments in the language of Feynman paths. Experiments discussed include the single photon Mach-Zehnder, Zhou-Wang-Mandel, and Hong-Ou-Mandel experiments. One of our reasons for departing from an historical approach is that for some concepts the current interpretation is significantly different from what it was in the first years after the formalization of quantum theory, having evolved in response to new evidence and emerging problems. A paradigmatic example is the uncertainty principle, which is today no longer thought as being the result of a perturbation of the system due to measurement (as in the Heisenberg microscope thought experiment), but as an intrinsic limitation in the available information about a quantum system.

In the final part of the sequence we provide students with a connection to the model of geometrical optics, by showing through simulations that, in the sum over paths approach, the “least time” path becomes increasingly dominant as the ratio between the wavelength of the photon and other characteristic length scales of the system gets smaller. Thus we “close the circle”, with a photon model of light which can explain quantum phenomena, and account for both the alternate models which students were accustomed to.

3. Key turning points

Interference in wave optics and the Huygens principle

The sum over paths method can initially be seen as a convenient way for describing interference phenomena in a classical wave perspective. In our presentation the method is introduced through a discussion of the Huygens principle, whose idea of a wave producing new wave sources at all points in space, has well known analogies with the path integral formulation. (Ogborn & Whitehouse, 2000) Students learn to compute the value of the amplitude of a monochromatic wave at a given point P in space by summing the amplitude vectors resulting from all possible “optical paths” that an elementary disturbance composing the wave could have followed to reach P from the original source S . The source-to-detector (Dobson, 2000) philosophy is central in the sum over paths perspective, and is often also an implicit assumption in the usual treatment of interference phenomena in wave optics.

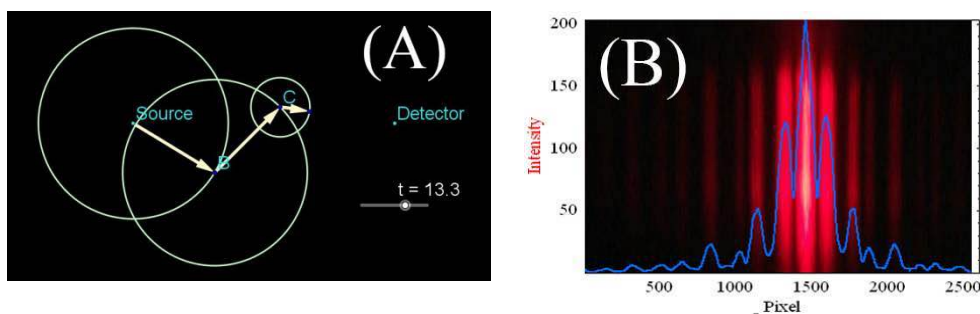

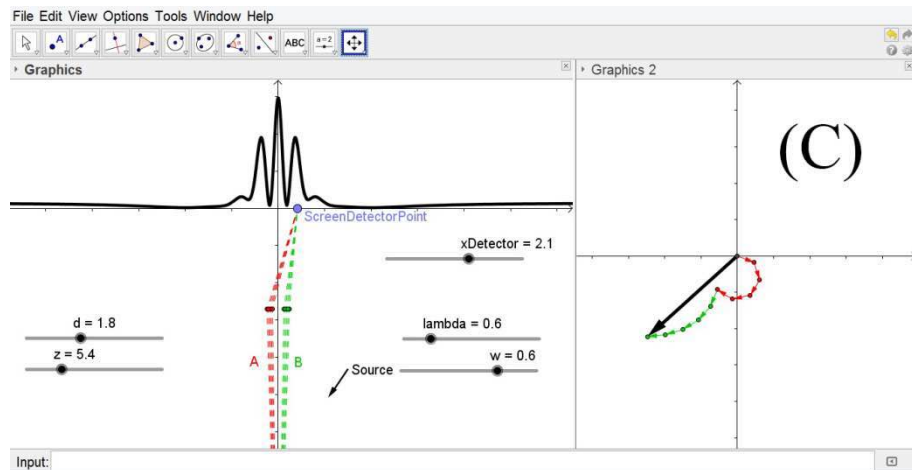

Figure 1. (A) Animation illustrating the connection between the Huygens principle and the idea of using all possible optical paths from source to detector. (B) Two slit interference pattern with superimposed Tracker analysis of the light intensity. (C) GeoGebra simulation of the two slit interference.

The photon concept and the Grangier experiment

In introducing the photon idea we use experimental evidence gathered at different times, in the unifying perspective of providing a logically convincing, unambiguous construction of the idea of photon and of its fundamental properties. In particular, we discuss the following experiments:

- The photoelectric effect, as basic evidence of *granularity* of light interacting with matter, and allowing to discuss the quantization relation $E = h\nu$.
- Two slit interference experiments with single photons (Jacques et al., 2005) introducing the *probabilistic interpretation*.
- The Grangier et al. 1986 experiment (Grangier et al., 1986) on photon *indivisibility*.

Our message to students can be summarized as follows: when light is thought of as a wave, it naturally has the property of being distributed in space so that, for example, it can pass through both of the two slits in the Young experiment, producing interference. But how can the phenomenon be explained if light is made of photons, and interference persists even if the intensity of light is so low that one at a time is emitted by the source? The Feynman idea of the photon following all possible paths is then presented as a logically consistent answer. In this perspective, the Grangier experiment (Figure 2) plays a very important role. In fact, students who are confronted with the phenomenon of single photon two slits interference, and the model of the photon following all possible paths from source to detector may form the hybrid (synthetic) conception of each photon splitting in two at the slits. The discussion of the Grangier experiment on photon indivisibility at this point is intended to address the specific difficulty at the precise moment when it may show up.

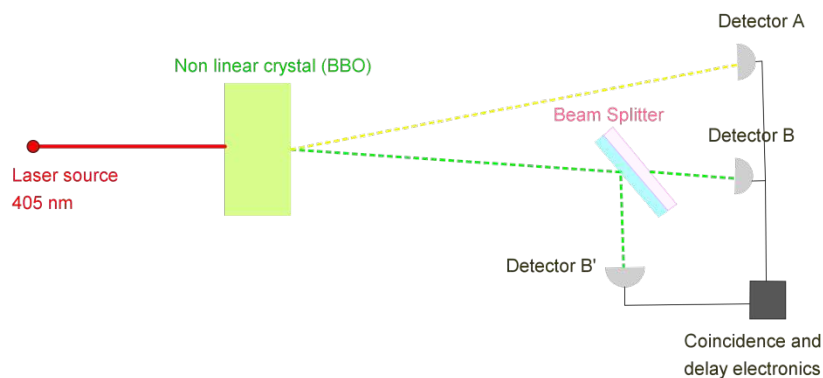

Figure 2. Setup for the Grangier experiment on photon indivisibility

Single slit diffraction: introducing the uncertainty principle

The phenomenon of single slit diffraction with a variable slit width is discussed, both experimentally and through the use of a simulation (figure 3), as a simple but effective introduction to the uncertainty principle (Johansson & Milstead, 2008). The diffraction pattern can be easily related to the momentum probability distribution of the diffracted photon, and as the slit width is varied in a simulation, an intuitive understanding of the meaning of the principle can be provided. Simple calculations lead to an approximate uncertainty relation $\Delta x \cdot \Delta p \approx h/2$.

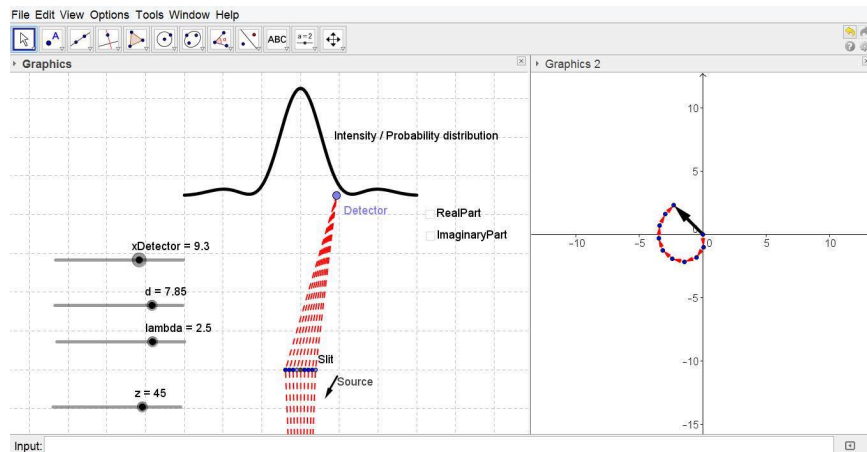

Figure 3. GeoGebra simulation for the single slit diffraction

We pay particular attention to making clear that the uncertainty principle should be interpreted as an intrinsic limitation to the information about complementary variables which quantum states can contain, and not as a perturbation of the system due to measurement.

Single photon Mach Zehnder: refuting the classical trajectory concept

The Mach-Zehnder interferometer can be used to provide a convincing proof of the untenability of the classical trajectory concept. In its base form, the experiment is used with the two arms having the same optical path length, so no phase shift is introduced between the two photon paths. In this case, one of the detectors (Detector 2 in figure 3) has zero probability of detecting the photon, while the other detects the photon with certainty.

The main point of interest in the experiment is to compare this result to what happens when either one of the two arms has been blocked: in this case, detectors A and B have the same probability of detecting the photon, since no interference happens. Thus one can conclude that results are incompatible with the hypothesis that, in the experiment with the full setup, the photon has gone through only one of the two possible paths. Once the idea has been introduced, we make a comparison to the case of two slit interference: indeed, in that case also the interference pattern is statistically incompatible with the two separate diffraction figures which would be obtained if only one of the slits was open. In this way students can reinforce the idea that the quantum object going through all possible paths simultaneously is a general feature of the theory, and not connected to the Mach-Zehnder setup only; however, we found that first reducing the outcome possibilities to only two detectors, rather than a continuous screen, has educational advantages for many students.

In our simulation (Figure 4) of the Mach-Zehnder interferometer, the Feynman approach allows to obtain an intuitive understanding of the experiment, in its possible setups.

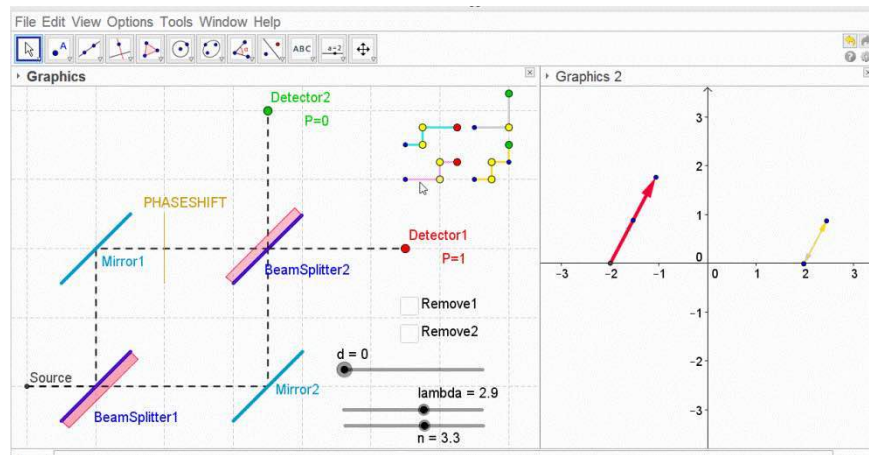

Figure 4. GeoGebra simulation for the Mach-Zehnder interferometer, with the sum of phasors for the relevant photon paths represented in the right window. Checkboxes allow to compare different situations, highlighting the impossibility of assigning a definite path to the photon.

The optical path of one of the arms can also be varied in the simulation through the insertion of a dielectric film (reflection at the interface is neglected in this case) of variable width. This offers the possibility for students to actually compute probabilities of detection, in a situation which is slightly different from the usual case of two slit interference.

Zhou-Wang-Mandel Experiment: in depth analysis of the problem of measurement

The Zhou-Wang-Mandel (ZWM) apparatus (Zhou et al., 1991) (figure 5) is a two way, single photon interference setup where “which way” information is collected in a non-destructive manner through a clever use of nonlinear crystals. The main result of the ZWM experiment consists in proving that the modification in the final outcome of an experiment due to an intermediate measurement, which is peculiar to quantum physics, should not be thought in terms of a disturbance, but of information acquired or recorded about the system. The language of the Feynman approach is particularly appropriate for summing up the lessons that can be drawn from the experiment. In particular, when the expression “all *possible* paths” is interpreted to mean “all paths *compatible with the information about the system*”, the idea of “wave function collapse” caused by a measurement, even if of non-destructive nature, is automatically retrieved.

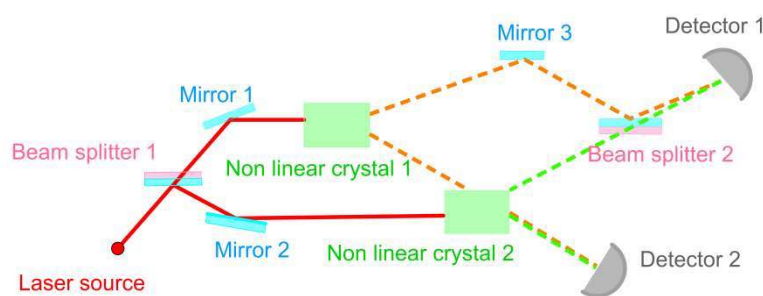

Figure 5. Schematic representation of the Zhou-Wang-Mandel experiment setup

Another purpose of discussing the ZWM experiment is to introduce a generalization of the concept of “path”. In fact, what is to be summed in the sum over paths approach are not necessarily only the possible word-lines of a single particle, but more generally, all possible *undistinguishable* processes leading to the same experimental outcome: undistinguishable, in the sense that no information can be retrieved about which one of the processes has happened. In fact, the possible paths leading to interference in the ZWM setup are not paths of the “same” photon, but of photons emitted by two different nonlinear crystals, which can be made undistinguishable. This point is even more evident in the famous Hong-Ou-Mandel (Hong et al., 1987) apparatus, where two different, but undistinguishable photons, are sent in the two inputs of a beam splitter. The possible outcomes of the experiment which only differ by an exchange of the two quantum objects

interfere destructively, leading (because of a property of beam splitters to produce a π phase loss for reflection at only one of their inputs) to the counterintuitive result of having no coincident clicks in the two detectors. An immediate consequence of this generalization is the possibility of introducing the schematic representation of processes in terms of Feynman diagrams.

The limit of geometrical optics

When the wavelength of the quantum object becomes much smaller than the relevant length scales, the sum over paths approach reproduces the results of geometrical optics. In fact, the dominant path for the photon in this limit is the one predicted by Fermat's principle. Simulations in which the wavelength of the quantum object can be interactively varied are essential at this stage; examples include light refraction at an interface and parabolic mirror reflection. The first one is represented in figure 6: an isotropic light source is placed near an interface between two media, with a detector placed beyond the interface. The shape of the "Cornu spiral" which appears in the right graphic window shows that the paths nearby to the one of minimum time give a larger contribution to the final amplitude. Also, the minimum time path becomes more and more dominant, as the wavelength decreases with respect to the source-detector distance. Paths which are very far from the ray of geometrical optics give essentially no contribution, since they go round in "curls" at the ends of the spiral.

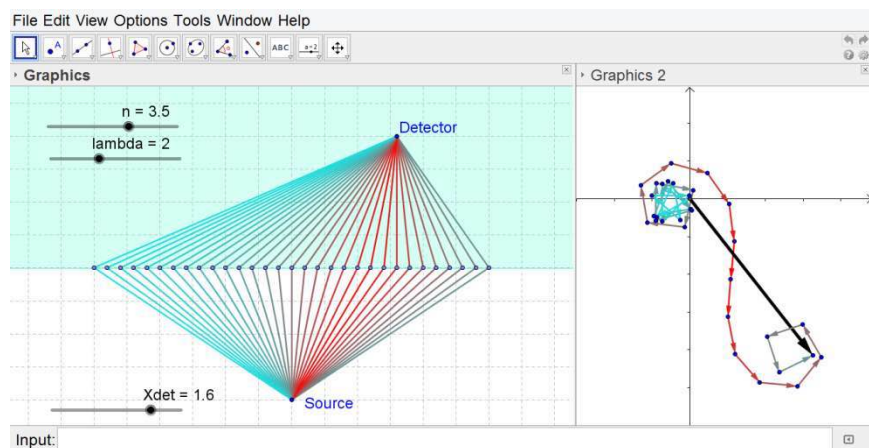

Figure 6. GeoGebra simulation for the refraction of light at an interface. In the right window the phasor arrows can be seen to form the characteristic "Cornu spiral".

4. Test with student teachers

We carried out a preliminary study with a group of 12 student teachers (ST). Most of the members were non-physicists (mathematicians or engineers), and their background in physics varied. 3 out of 12 ST had never previously had any formal training in modern physics; 5 had followed only one college course, 4 more than one course.

We proposed our sequence in a course which lasted 8 hours, divided in session of two hours each, and included presentation of the material, student exploration of simulations with guided activities, open discussion about conceptual themes, and home exercises to be solved through an online discussion. In the first and final sessions, pre- and post- tests were proposed.

Pre-test data

Data from the pre-test showed ST to be completely unfamiliar with a description of light in terms of photons, and very confused about conceptual aspects of quantum theory. 11 ST out of 12 were unable to provide a description of the two slit experiment in terms of photons. Most ST could not name any differences between classical and quantum physics, and none of them was able to provide an entirely satisfying definition of the uncertainty principle. 10 ST provided an inadequate picture of wave particle duality.

Data from post-test

The main aspects we probed in the post test were:

- Whether students were comfortable with quantum model of light, and could explain interference phenomena in terms of individual photons.

- Whether students had reached a satisfying level of confidence and an appropriate language in discussing conceptual and epistemological themes of quantum physics.
- Whether students could use the model to compute probabilities of detection in simple cases.

In a post-test exercise very similar to a pre-test one, requiring to interpret a slightly modified two slit experiment in terms of individual photons, ST provided accurate descriptions and showed a noticeable confidence with the sum over paths language:

“In terms of paths, all possible paths passing through A experience a phase change of π when the film is applied. So, where before the vectors were in phase and the probability of detection was maximum, now the vectors are in phase opposition and give probability $P=0$.”

When asked to directly discuss the role of measurement in quantum physics, comparing it to its role in classical physics. Answers produced by ST were, in general, extremely satisfactory, displaying a precise and secure use of language and concepts. Several students mentioned that, in the Feynman picture, acquisition of information on the system restricts its possible paths to only those compatible with the acquired information, which is a formulation of the “wave function collapse” concept. ST convincingly made the point that the very fact of acquiring information about the system, and not some sort of disturbance, is responsible for the restriction in the possible paths.

“If I have a way of knowing which slit the photon goes through, the interference pattern is lost. And this would happen even if I were a “perfect” observer, perfectly “transparent” to the photon passage.”

Finally, open and multiple choice exercises showed that ST had acquired sufficient mastery of the sum over paths approach to be able to compute detection probabilities. Online discussion of assigned exercises revealed that one issue several students were confused about was the normalization of probabilities. Thorough discussion of the Mach-Zehnder interferometer, which only has two possible outcomes, and additional exercises exploring this particular problem were useful strategies for dissipating their doubts.

5. Conclusions

We propose an educational path meant to provide students with an unifying picture of light based on its quantum model, and to introduce them to the most important conceptual and epistemological themes in quantum theory. Although not discussed in this paper, the path has been straightforwardly extended to a comprehensive introduction to quantum theory with the introduction of massive particles, and the discussion of bound systems and quantization from the point of view of Feynman paths (Onorato, 2011; Malgieri et al., 2014).

Feynman’s sum over paths approach allows us to offer students a visualization of the quantum model of light which is not misleading and does not contain hybrid quantum-classical elements.

We use the sum over paths method both as a computational tool and as a conceptual point of view, from which we analyze some epistemological themes of quantum physics, aiming at making them clearer and more acceptable for students. We discuss modern experiments in quantum optics carrying a deep conceptual meaning, and allowing to introduce a modern, information based foundational point of view.

Based on the results of this study, our approach appears to be very promising, leading ST to take hold of quantum concepts and acquire an expert-like language in a very short time. Students appear satisfied by the internal models they create using Feynman’s approach .

Our proposal makes extensive use of interactive simulations, which we designed using the open source software GeoGebra. Simulations are built on an interface which many teachers already use in their educational practice. This can encourage them to modify the provided examples, adapting them to their own needs.

References

- Cuppari, A., Rinaudo, G., Robutti, O., and Violino, P. (1997). Gradual introduction of some aspects of quantum mechanics in a high school curriculum. *Physics Education*, 32(5), 302.
- De los Angeles Fanaro, M., Otero, M. R., and Arlego, M. (2012). Teaching Basic Quantum Mechanics in Secondary School Using Concepts of Feynman Path Integrals Method. *The Physics Teacher*, 50(3), 156-158.
- Dobson, K., Lawrence, I., and Britton, P. (2000). The A to B of quantum physics. *Physics Education*, 35(6), 400.
- Grangier, P., Roger, G., and Aspect, A. (1986). Experimental evidence for a photon anticorrelation effect on a beam splitter: a new light on single-photon interferences. *Europhysics Letters*, 1(4), 173.

- Hohenwarter, J., Hohenwarter, M., & Lavicza, Z. (2009). Introducing dynamic mathematics software to secondary school teachers: The case of GeoGebra. *Journal of Computers in Mathematics and Science Teaching*, 28(2), 135-146.
- Hong, C. K., Ou, Z. Y. and Mandel, L. "Measurement of subpicosecond time intervals between two photons by interference." *Physical Review Letters* 59.18 (1987): 2044.
- Jacques, V., Wu, E., Toury, T., Treussart, F., Aspect, A., Grangier, P., & Roch, J. F. (2005). Single-photon wavefront-splitting interference. *The European Physical Journal D-Atomic, Molecular, Optical and Plasma Physics*, 35(3), 561-565.
- Johansson, K. E., and Milstead, D. (2008). Uncertainty in the classroom—teaching quantum physics. *Physics Education*, 43(2), 173.
- Malgieri, M., Onorato, P., and De Ambrosis, A. (2014). Teaching quantum physics by the sum over paths approach and GeoGebra simulations. *European Journal of Physics*, 35(5), 055024.
- Ogborn, J., and Whitehouse M.. *Advancing Physics AS (with CD ROM)*. 2000, Institute of Physics and Physical Society (London).
- Onorato, P. (2011). Low-dimensional nanostructures and a semiclassical approach for teaching Feynman's sum-over-paths quantum theory. *European Journal of Physics*, 32(2), 259.
- Taylor, E. F., Vokos, S., O'Meara, J. M., and Thornber, N. S. (1998). Teaching Feynman's sum-over-paths quantum theory. *Computers in Physics*, 12, 190.
- Zhou, X. Y., Wang, L. J., and Mandel, L. (1991). Induced coherence and indistinguishability in optical interference. *Physical review letters*, 67(3), 318-321.

Affiliation and address information

Massimiliano Malgieri, Pasquale Onorato, Anna De Ambrosis
University of Pavia Physics Education Research Group
Department of Physics, University of Pavia
Via Agostino Bassi, 6
27100 Pavia, PV, Italy
massimiliano.malgieri01@ateneopv.it,
pasquale.onorato@unipv.it,
anna.deambrosisvigna@unipv.it

Report and Recommendations on Multimedia Materials for Teaching and Learning Quantum Physics

**Bruce Mason¹, Ewa Dębowska², Tanwa Arpornthip³, Raimund Girwidz⁴,
Tomasz Greczyło², Antje Kohnle⁵, Trevor Melder⁶, Marisa Michelini⁷,
Lorenzo Santi⁷, Jorge Silva⁸**

¹*University of Oklahoma (US)*

²*University of Wrocław (PL)*

³*University of Virginia (US)*

⁴*Ludwig Maximilian University Munich (DE)*

⁵*University of St. Andrews (UK)*

⁶*University of Louisiana, Monroe (US)*

⁷*University of Udine (IT)*

⁸*Henrique Medina Secondary School (PT)*

Abstract

An international collaboration of physicists, affiliated with Multimedia Physics for Teaching and Learning (MPTL) and MERLOT, performed a survey and review of multimedia-based learning materials for quantum physics and quantum mechanics. The review process was based on more than a decade of experience with similar topical learning material reviews. A total of approximately 250 items were considered for review and eight were recommended by the reviewers. These are described in this report. Observations about quantum learning resources and multimedia tools are included.

Keywords

Quantum Physics, Multimedia, Learning Resources

1. Introduction

For more than a decade a group of physicists affiliated with the Multimedia Physics for Teaching and Learning (MPTL) workshops has performed an annual review of the state-of-the-art in multimedia-based teaching and learning resources. Each year this working group selects a physics topic, searches for freely available, interactive learning resources, and performs a structured review on the best of these materials. Details of this process have been published in previous reports [MPTL 2014, Dębowska 2013], including the ongoing collaboration with the MERLOT Physics Editorial Board [MERLOT 2014].

The topic of the 2014 MPTL review effort was Quantum Mechanics and Quantum Physics. This was the first topic considered by the MPTL group in 2002 during the original development of the review process. Quantum resources were also reviewed in 2008, making this the first subject to be reviewed a third time. This highlighting of quantum physics is due, in part, to the high level of interest of students in the topic coupled with the non-intuitive and graphical nature of the subject. Quantum physics is a natural application of multimedia simulations and tutorials.

Over the years a number of research groups have been involved in the development of visualizations and interactive simulations of quantum systems meant to aid in learning, and in education research on best practices of use of these materials. For example, Zollman and collaborators at Kansas State University developed and tested a series of tutorials for the introduction of quantum concepts in introductory physics [Zollman 2002]. This paper also provides an excellent summary of previous efforts in using multimedia for topics in quantum mechanics. Singh and co-workers started with research on student conceptions in quantum mechanics to develop a series of tutorials similar to those developed for introductory physics and other physics topics. These Quantum Interactive Learning Tutorials (QuILTs) take advantage of a number of interactive simulations on concepts in quantum physics [Singh 2008]. The PhET group at the University of Colorado has performed extensive research and development work on the use of simulations for teaching quantum physics [McKagan 2008]. Their work has indicated the importance of game-like, open-ended environments for student-centered learning, the benefits of making real world connections to help develop mental models, and the need to carefully frame the simulation to avoid reinforcing student misunderstanding.

This research work is of great benefit in the evaluation of multimedia resources by the MPTL working group.

2. Resource Discovery and Selection

As has been described in previous reports, the first step in the review process is to collect available learning materials. For this year's review, materials were gathered from the 2002 and 2008 review lists, from digital library collections ComPADRE [ComPADRE 2014] and MERLOT/Quantum [MERLOT 2014], from other collections on the web such as Didattica [Didattica 2014] and Multimedia Physik [Multimedia Physik 2014], general web searches, and searches of the traditional literature.

The result of the discovery process was a list of 250 items that included both collections of multiple learning objects, simulations, and tutorials and single resources developed to address a specific topic. A preliminary review of this list resulted in 32 items being selected for full reviews. These were mostly collections of materials covering multiple topics in quantum. This preliminary selection was based on the MPTL review rubric [Dębowska 2013] and experiences with past reviews. Materials that were not freely available, did not make significant use of multimedia, or did not have an English version available were not included in the final review. The restriction to English materials is necessary to assure that multiple reviewers were available to evaluate each item or collection.

The Appendix provides a list of materials that either received full reviews or were considered to be good quality and of potential use to teachers and students, although not suitable for review.

The result of this year's discovery and selection process was a somewhat larger collection of materials. In 2008, 110 items or resource collections were found and 23 received full reviews. The 2002 review had much fewer items because of the exploratory nature of this first attempt at the review process.

3. Review Process

Each of the items selected for full reviews was considered by two or three reviewers. Materials were rated with the MPTL review rubric with an overall score and scores in the categories: Motivation and Purpose, Content, and Method. Reviews were completed using the ComPADRE peer reviewing tools that allow reviews to be entered and archived for later use. Reviews were collected and compared, with those receiving high scores from all reviewers considered "Recommended" by the review process.

4. Review Results

Of the 32 items receiving full reviews, eight received "Excellent" or "Very Good" ratings from all reviewers. These items are listed below with descriptions, comments, and recommendations from the reviews.

QUVIS:

<http://www.st-andrews.ac.uk/physics/quvis/>, <http://quantumphysics.iop.org/>

This is an extensive collection of Flash and HTML5-based tutorials with interactive simulations of quantum systems and step-by-step explanations of the concepts involved. The presentations have very attractive graphics and clear explanations, with the step-by-step tutorials particularly noteworthy for helping students focus on the important physics. The Physics Simulations take students through the traditional sequence used in most quantum courses, from the concepts of probability to perturbations and Fermi and Bose statistics. The New Quantum Sims are used as the multimedia resources in the IOP Quantum Physics web site. This work focuses on quantum optics and quantum information theory, with many simulations using Stern-Gerlach experiments as their example. Almost all of the items include student activities and didactic recommendations, with the IOP site providing extensive tutorial and reference resources supplemented by the simulations. The translation of this material to HTML5 for use on all platforms is of particular note.

An excellent example of the QUVIS materials is the Hidden Variables simulation. This is one of the culminations of the entire collection. It shows the virtual experiment and the different results of quantum and hidden-variable theories.

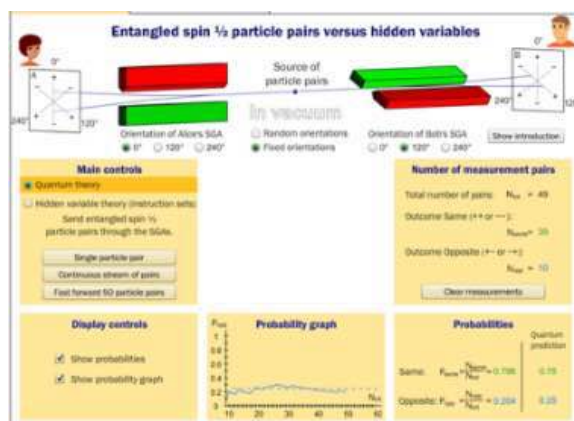

Figure 1. QUVIS: Quantum mechanics vs Hidden Variables

PhET:

<http://phet.colorado.edu/en/simulations/category/physics/quantum-phenomena>

This is a collection of easy-to-run simulations suitable for middle-school (a few), high school, and college. These simulations are highly interactive and open environments with drag-and-slide user interfaces and game-like immediate feedback. The simulations can be used in a range of different ways, homework, pre-labs, and in-class explorations. Most of the simulations have recommendations for instructors, including learning goals and example activities. General recommendations for using simulations are also available. The reviewers also emphasized the fact that the PhET materials are available in a wide range of languages.

The PhET simulations are carefully researched and designed for interactivity and student learning. Many of these simulations are connected to “modern physics” experiments, such as lasers, the photoelectric effect, Stern-Gerlach, and Davisson-Germer experiments rather than “pure quantum theory”. The Teacher Tips provide some information about the models and approximations used in the simulations, as well as student understanding of the topic and details about operation of the simulation.

An excellent example of a simulation of standard quantum problems is the Quantum Bound State. A noteworthy example of a virtual experiment is the Photoelectric Effect.

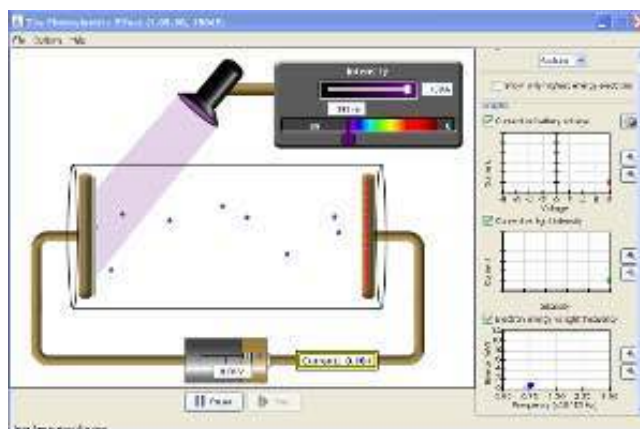

Figure 10. PhET Photoelectric Effect Simulation

Physlet Quantum Physics:

<http://www.compadre.org/ppq/>

This online textbook supplement of interactive illustrations and problems covers topics ranging from experiments demonstrating quantum phenomena, through standard bound and scattering state physics, to applications in atomic, nuclear, and statistical physics. Users can control states, energy levels, potentials, etc.

and observe the resultant changes. Students may explore quantum systems for themselves with the help of guiding questions that range from qualitative ranking tasks to quantitative calculations.

One reviewer felt that the Physlet Quantum Physics simulations' graphics are somewhat dated and simple. They also noted that words such as " $\psi^*(x) \cdot \psi(x)$ " are used in simulations rather than Greek letters. Those interested in exploring Physlet Quantum Physics might consider Problem 9.4, Scattering in 1D. This is an example of the type of questions that encourage explorations. The physics behind an animation of a scattering state needs to be understood to answer questions about energy and potentials. Similarly, Problem 13.7 is an interesting exploration of the level dependence of the probability density for a Hydrogen atom.

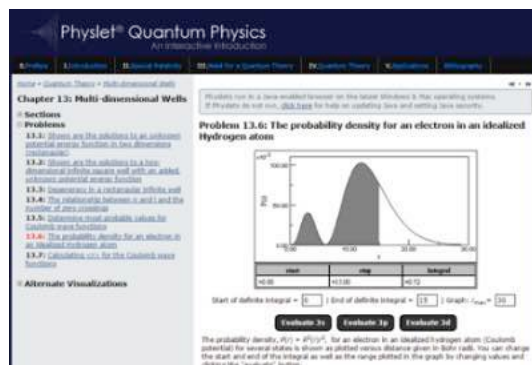

Figure 11. Physlet Physics Exploration of Probability Density

Quantum Lab:

<http://www.didaktik.physik.uni-erlangen.de/quantumlab/english/index.html>

This is a set of Interactive Screen Experiments covering quantum optics. Each of the experiments are illustrated with images of real experiments. Real data is provided when the experiments are “turned on”. Quantum entanglement, quantum cryptography, and other quantum information experiments are included along with more basic examples. This content can be used as pre-labs for schools with the facilities to perform quantum optical experiments, or as entirely virtual labs. Each experiment is well described, with motivating introductions and explanations of the observations.

Reviewers noted that some design and layout of the controls is problematic, with control placement and design changing in different experiments. The ability to zoom in on parts of the experiment is a plus. Some of the data is in German.

To start exploring this material, the Existence Photon experiment can give an indication of its interface and display of real optics experiments. A more sophisticated experiment, such as Entanglement, will show how data is displayed.

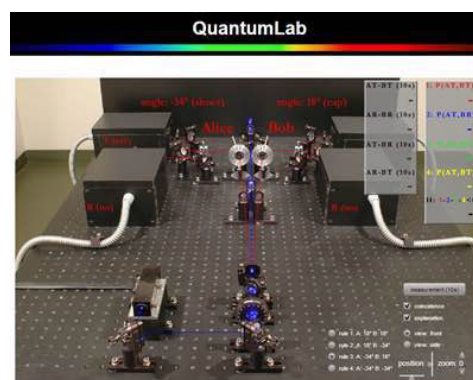

Figure 12. QuantumLab Entanglement & Non-locality

Spins Physics:

http://www.physics.orst.edu/~mcintyre/ph425/spins/index_SPINS_OSP.html,

<http://www.compadre.org/osp/items/detail.cfm?ID=7329>

The Oregon State University SPINS web site provides a complete set of course materials (worksheets, virtual labs, in-class activities, and homework) for a quantum mechanics course that begins by studying spin systems. The Open Source Physics (OSP) package integrates these tutorials with simulations for student investigations. The software allows students to drag, drop, and connect elements of a Stern-Gerlach experiment including spin analysers, magnets, and detectors. The interface allows students to create many different experiments on quantum dynamics and quantum measurement. The simulation is simple to use, but is rather schematic so students may not understand precisely what is being observed. The software can be used for different sorts of learning activities. This work is based on the “SPINS” software package that has been developed over the years by several different programmers [Schroeder 1993]. A good example of the Spins tutorial material can be found under “Exercises” and the tab for “Spin Precession” at the bottom of the page. This series simulations are arranged to help students understand the quantum rotation of spins in magnetic fields.

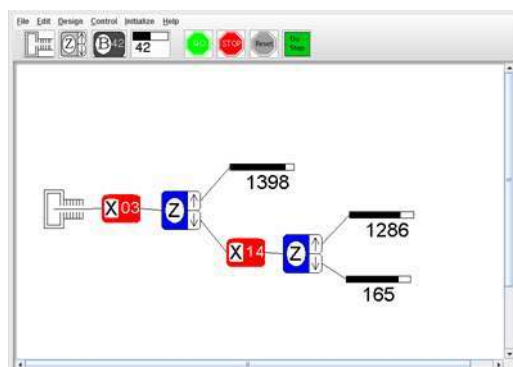

Figure 13. Spins Stern-Gerlach Simulation

Falstad Quantum:

<http://www.falstad.com/mathphysics.html>

This well-known web site provides good qualitative illustrations of quantum mechanics and complex systems. Some of the physics topics simulated are unique. Of note are the dynamic quantum transitions applets for a bound state interacting with a classical oscillating electric field.

This material, however, is somewhat limited in the topics covered and lacks didactic materials or recommendations. Rather basic explanations about the simulations are provided, most covering only how to run the simulation. Details about the physical models and simulation methods use are not available for many of these programs.

One excellent example of the Falstad work is the Atomic Dipole Transitions applet. It considers the dynamics of an atom interacting with different types of electric field. The Rigid Rotator and the Square Well applets illustrate the displays provided.

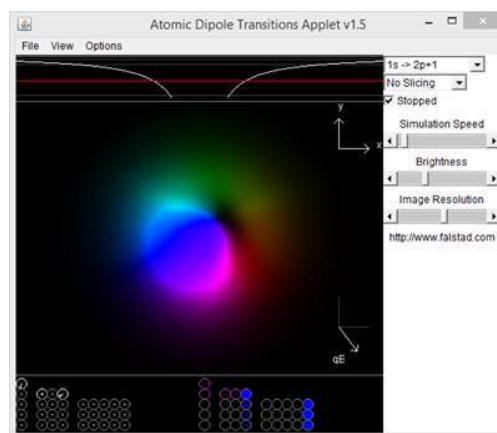

Figure 14: Paul Falstad Atomic Dipole Transition

Quantum Mechanics:

<http://www.embd.be/quantummechanics/default.html>

This combination of text and videos provides a multimedia tutorial on quantum mechanics. Topics include wave motion and interference, Aharonov-Bohm effect, and identical particles. The sequence of topics leads the reader through important aspects of quantum physics.

The video simulations are somewhat dated and lower resolution, and are not interactive. One reviewer felt that there could be more questions and tasks for the student.

For those interested in this work, the Aharonov-Bohm section is a rather unique study of this physics.

Excited States and Photons:

<http://concord.org/stem-resources/excited-states-and-photons>

This material is a secondary school level introduction to the interaction of light and matter, including quantization of energy. The connection between atomic energy levels and emitted photons is stressed. Multiple choice and free-response questions throughout provide tutorial guidance. The materials are easy to follow and the goals and learning approaches are clear. The coordinated use of pictures, animations, words, and interactive simulations was noted by one reviewer. This could also be used in conceptual physics classes at the college level.

An example of the tutorial nature of this work is the second half of the activity where atomic energy levels, photon colour, and kinetic energy are connected.

5. General Observations

From the results of this review and a comparison to previous years, some general observations can be made.

- Several of the recommended items (PhET, Physlets, SPINS, Falstad, and Quantum Mechanics) were recommended in the 2008 Quantum review. The other recommended items are new.
- Three items from 2008 were not recommended this year. One of these, Visual Quantum Mechanics from Kansas State University, received good marks, but some reviewers had difficulties running the items and some links between the VQM tutorials and simulations were broken due to recent updates of the simulations and web site.
- All of the 2008 recommended materials are still available on the web, although some have changed URL. In fact, four of the six recommended items from 2002 are still available. However, if teachers are going to continue to have access to the resources, a means for providing updated links to materials is needed, such as an indexing service or curated digital libraries.
- Java, Flash, and Shockwave, the programming languages of most of the resources reviewed, are becoming increasingly problematic to use. This is because of security issues, constant updates, and new devices not designed to run these languages. Some reviewers had difficulty starting and running a few applets or applications.
- On a related note, some of the established developer groups (PhET, QuVis, OSP, Concord Consortium) are working at providing resources through html5 and javascript. This will expand the types of devices that can access the materials. However, individuals who have created materials probably will not have the time and resources to do these updates.
- As has been true for several years of reviews, resources that are more comprehensive, cover multiple topics, and provide tutorial and didactic support received the highest reviews.
- There were several items that received “Very Good” and “Average” ratings, meaning that they are probably quite useful for teachers or students but are not included in our “Recommendations”.
- The review group also explored apps designed specifically for either iOS or Android devices. Although some examples were found, these were mostly illustrations of quantum states with little interactivity or direct pedagogical use.
- As has been noted in several past reviews, there are many video collections available on the web covering physics topics. These have not been included in this review process because of the lecture-like nature of most. Though potentially useful, these videos do not have the interactivity, student engagement, immediate feedback, or multi-modal features stress in the multimedia review rubric.

There were two items reviewed that were not included in the “Recommended” category, because they are not applicable for quantum physics courses, but the reviewers felt were noteworthy. “Quantum Made Simple”, <http://www.toutestquantique.fr/>, is quite interesting and unique. The material is designed as a very brief introduction to quantum for a general audience. It gives a layman’s introduction of topics such as

quantization, spin, and lasers, and adds animations and applications of the concept to laboratory or real-world uses. Another item of interest is the Open Source Physics Quantum Magnetism simulation, <http://www.compadre.org/osp/items/detail.cfm?ID=12308>. This is a very specific modelling simulation for the spectrum of coupled spins in a magnetic field. It is designed for more advanced users but provides an interactive environment for exploring an interesting topic in quantum physics.

The MPTL multimedia evaluation group members plan to continue to perform this activity in future years. The topic for review in 2015 will be optics.

Appendix

Table 1 is a list of resources that either received full reviews or were high on the review priority list but were immediately below the cut-off for review. The list is in alphabetical order by title.

Table 16. Items reviewed and near the review cut-off

Title	URL
1-d Schrodinger Equation Eigenstates	http://www.fen.bilkent.edu.tr/~yalabik/applets/1d.html
Bernd Thaller VQM	http://vqm.uni-graz.at/
Circular Well Superposition Model	http://www.compadre.org/osp/items/detail.cfm?ID=8327
Concord Consortium: Excited States & Photons	http://concord.org/stem-resources/excited-states-and-photons
Concord Consortium: Introduction to Quantum Mechanics	http://concord.org/stem-resources/introduction-quantum-mechanics
EJS Photoelectric Effect	http://www.compadre.org/osp/items/detail.cfm?ID=10272
Expansion and Time Development using Eigenstates	http://www.fen.bilkent.edu.tr/~yalabik/applets/superp.html
Gallery of Quantum Optics States	http://gerdbreitenbach.de/gallery/
HydrogenLab - Pictures of the Hydrogen Atom	http://www.hydrogenlab.de/
IOP Quantum Physics	http://quantumphysics.iop.org/
Math, Physics, and Engineering Applets	http://www.falstad.com/mathphysics.html
Molecular Workbench: Physics examples	http://mw.concord.org/modeler/showcase/physics.html
Momentum Space Package	http://www.compadre.org/osp/items/detail.cfm?ID=7304
Numerical Time Development in Quantum Mechanics Using a Reduced Hilbert Space Approach	http://www.compadre.org/osp/items/detail.cfm?ID=6475
OSP: Quantum-mechanical Measurement	http://www.compadre.org/osp/items/detail.cfm?ID=3943
Path Integrals in Quantum mechanics	http://fisteo12.ific.uv.es/~santamar/qapplet/metro.html
PhET Simulations: Quantum Phenomena	http://phet.colorado.edu/en/simulations/category/physics/quantum-phenomena
Physics 2000: Quantum Atom	http://www.colorado.edu/physics/2000/quantumzone/index.html
Physics 2000: Wave Interference	http://www.colorado.edu/physics/2000/schroedinger/index.html
Physics Virtual Bookshelf	http://faraday.physics.utoronto.ca/PVB/Harrison/Flash/#qm
Physlets Quantum Physics	http://www.compadre.org/pqp/
QM Measurement Program	http://www.compadre.org/osp/items/detail.cfm?ID=6814

QM Projection Program	http://www.compadre.org/osp/items/detail.cfm?ID=7010
QM Superposition Package	http://www.compadre.org/osp/items/detail.cfm?ID=7295
Quantum Computation	http://math-it.org/Quantum/index.html
Quantum Made Easy	http://www.toutestquantique.fr/
Quantum Magnetism Analysis Model	http://www.compadre.org/osp/items/detail.cfm?ID=12308
Quantum Mechanics	http://www.embd.be/quantummechanics/
Quantum Mechanics: Sum over paths	http://www.eftaylor.com/quantum.html
Quantum Physics Online version 2.0	http://www.quantum-physics.polytechnique.fr/
QuantumLab	http://www.didaktik.physik.uni-erlangen.de/quantumlab/english/index.html
QuVis	http://www.st-andrews.ac.uk/physics/quvis/
Rectangular Well Superposition Model	http://www.compadre.org/osp/items/detail.cfm?ID=9637
Six Ideas that Shaped Physics	http://www.physics.pomona.edu/sixideas/sicpr.html
SPINS Java Homepage	http://www.physics.orst.edu/~mcintyre/ph425/spins/index_SPINS_OSP.html
Spins Package	http://www.compadre.org/osp/items/detail.cfm?ID=7329
The Basics of MRI	http://www.cis.rit.edu/htbooks/mri/index.html
The Stern-Gerlach Experiment	http://www.if.ufrgs.br/~betz/quantum/SGtext.htm
The Stern-Gerlach Experiment, Electron Spin, and Correlation Experiments, Linked Animations	http://www.upscale.utoronto.ca/PVB/Harrison/SternGerlach/SternGerlach.html
Visualizing Quantum Dynamics	http://comp.uark.edu/~jgeabana/blochapps/
VQM Software Page	http://web.phys.ksu.edu/vqm/software/online/vqm/index.html
VQM Tutorials Page	http://web.phys.ksu.edu/vqm/tutorials/

References

- ComPADRE (2014), ComPADRE Digital Library, <http://www.compadre.org>, (Accessed 11/11/2014).
- Dębowska, E., et al. (2013). Report and Recommendations on Multimedia Materials for Teaching and Learning Electricity and Magnetism, *Eur. J. Phys.* **34**, L47 – L55.
- Diddattica (2014), Risorse per la didattica di Fisica, <http://zitogiuseppe.com/didattica.html>, (Accessed 11/11/2014).
- McKagan, S., et al. (2008), Developing and researching PhET simulations for teaching quantum mechanics, *Am. J. Phys.* **76**, 406-417.
- MERLOT/Quantum (2014), MERLOT Quantum Physics, <http://www.merlot.org/merlot/materials.htm?category=2736>, (Accessed 1/11/2014).
- MPTL (2014), MPTL website, <http://www.mptl.eu/>, (Accessed 11/11/2014).
- Multimedia Physik (2014), website, <http://www.schulphysik.de/> (Accessed 11/11/2014)
- Schroeder, Daniel V., Moore, Thomas A. (1993), A computer-simulated Stern-Gerlach laboratory, *Am. J. Phys.* **61**, 798 – 805.
- Singh, Chandralekha (2008), Interactive learning tutorials on Quantum Mechanics, *Am. J. Phys.* **76**, 400 – 405.
- Zollman, Dean A., Rebello, N. Sanjay, Hogg, Kirschen (2002), Quantum mechanics for everyone: Hands-on activities integrated with technology, *Am. J. Phys.* **70**, 252 – 259.

Affiliation and address information

Ewa Dębowska
Institute of Experimental Physics
University of Wrocław
pl. Maksa Borną 9
50-204 Wrocław, Poland
Email: ewa.debowska@ifd.uni.wroc.pl

Chaotic Behaviour of Zeeman Machines at Introductory Course of Mechanics

Péter Nagy¹, Péter Tasnádi²

¹Faculty of Mechanical Engineering and Automation, Kecskemét College, Kecskemét, Hungary

²Faculty of Science, Eötvös Loránd University, Budapest,

Abstract

Investigation of chaotic motions and cooperative systems offers a magnificent opportunity to involve modern physics into the basic course of mechanics taught to engineering students. In the present paper it will be demonstrated that Zeeman Machine can be a versatile and motivating tool for students to get introductory knowledge about chaotic motion via interactive simulations. It works in a relatively simple way and its properties can be understood very easily. Since the machine can be built easily and the simulation of its movement is also simple the experimental investigation and the theoretical description can be connected intuitively. Although Zeeman Machine is known mainly for its quasi-static and catastrophic behaviour, its dynamic properties are also of interest with its typical chaotic features. By means of a periodically driven Zeeman Machine a wide range of chaotic properties of the simple systems can be demonstrated such as bifurcation diagrams, chaotic attractors, transient chaos and so on.

The main goal of this paper is the presentation of an interactive learning material for teaching the basic features of the chaotic systems through the investigation of the Zeeman Machine.

Keywords

Catastrophe phenomenon, Zeeman-machine, harmonically excitation, chaos, simulations.

1. Introduction

This work is organically linked to our website [1] where the electronic materials (reading PDF files, simulation programs and videos) could be downloaded (the elements of the electronic material will be denoted by #). The theoretical background of the simulations will be summarized here only shortly because it can be found in our previous paper [2]. In the present paper it will be demonstrated that the Zeeman Catastrophe Machine can be a versatile and motivating tool for students to get introductory knowledge about chaotic motion via interactive simulations. For the numerical investigations we have used the *Dynamics Solver* which can be downloaded freely from website [3] and on our website [1] a short description of the program is also available (# *ds_brief_tutorial.pdf*).

Ever since Edward Lorenz has discovered that simple nonlinear systems can produce inherently unpredictable behaviour, which is called chaotic motion, the interest in the theory of it has risen rapidly, and much effort has been invested in integrating it into the graduate as well as the undergraduate curricula. Excellent introductory monographs are available which explain the basic ideas and concepts [4], and in which a wide variety of simple mechanical systems producing chaotic behaviour are deployed [5-7]. Maybe, in the light of these, it seems to be a superfluous effort to increase the number of examples of the simple chaotic systems. Although the scepticism is reasonable, we think that the Zeeman Machine got exceptional advantages as a teaching material. It will be proven that in spite of its simplicity, by investigating it, a broad range of characteristics of chaotic motion can be covered which generally needs the discussion of several different systems. The machine was originally prepared for the demonstration of the catastrophe phenomenon which is a result of a quasi-static process. However, applying a periodic driving force it produces chaotic motion which can be easily studied both theoretically and experimentally. Initial enthusiasm and motivation of students are often lost, when they are unable to understand the theory behind chaotic behaviour. The Zeeman Machine provides an easily understandable theoretical background of various chaotic features, and gives an insight into the dynamics of chaotic motion. Simulations of the motion help us to avoid too mathematical or abstract teaching, and interactive programs support the exploratory activities of the students. Therefore a very important requirement for the electronic material is that the

software should be easily usable by the student. Software available for the simulations of the dynamics of physical systems can be classified into three categories:

- high level programming languages: Pascal/Delphi, C/C++, java, python, etc.,
- programs for general purpose: Maple, MathCad, Mathematica, MatLab, etc.,
- user programs for special purpose (in our case programs which are modelling dynamic systems): Dynamics Solver, E&F Chaos, Phaser, XPP, Pyndamics, etc.

Searching the adequate program for the simulation of the Zeeman system programs were investigated according to the following point of view:

- availability (and expenditure),
- programming skills needed and the estimated programing time of the simulation,
- validity and reliability,
- speed and accuracy.

Table 1. Comparison of the programs

	Pascal	Maple	Dynamics Solver
availability	free downloadable exists (e.g. FreePascal)	very expensive	free.
preliminary knowledge	advanced programming knowledge needed, to write a simulation program requires more hours	basic level programming skills needed, to produce a worksheet requires some hours.	programming skills are not necessary, one or two hours are sufficient to produce a simulation
Validity	the program is based on the programmer's own routines therefore the validity cannot be decided generally.	built in programs guarantee the high level	high level, validity and reliability are.
speed and accuracy	It is very speedy the accuracy should be checked due to the number representation used in it	very slow, but it is extremely accurate due to the number representation used	very rapid and accurate.

To illustrate this procedure software was chosen from all three groups and with the use of them the same problem was solved. (A stroboscopic map was produced for a damped pendulum the suspension point of which is moving uniformly on a vertical circle.)

Table 1. shows the extremely good properties of the Dynamics Solver. These properties are combined with high flexibility in modelling physical systems.

We have applied the Dynamics Solver both in university teaching and in our research work successfully. The only disadvantage of it is that it can be used only at Windows platform (although it runs at Linux, Unix and Mac platforms at the free WINE compatible platform which is in our opinion is a reliable possibility)

2. Catastrophe phenomenon and Zeeman's Machine

Those systems whose temporal evolution (dynamics) is defined uniquely by rules are called deterministic systems. *Catastrophe theory* deals with the description of the quasi-static motion of those deterministic systems in which small, continuous changes in one or more parameters cause abrupt, discontinuous, dramatic changes in the equilibrium state of the system. The Catastrophe Machine bearing his name was created by E. C. Zeeman in the 1970's to illustrate and study catastrophe phenomena [8]. The device is very simple

(anyone can build it) and can easily be studied quantitatively. Fix a flat disk of radius R with an axle at a point of a rigid sheet. Take two identical rubber strings with an unstretched length of L_0 , fasten one end of one of the rubber strings to the circumferential point P of the disk and the other end of the string, slightly stretching it, in point $A(-A, 0)$ of the sheet. Fasten one end of the other string at point P of the disk, and let the other end hang free. In our experiments, we will move this end B in the plane of the sheet. For the quantitative description, establish a coordinate system in the plane of the sheet, whose origin is the centre of the disc, its X-axis is a straight line through points A and O (figure 1), and its Y-axis is perpendicular to this straight line.

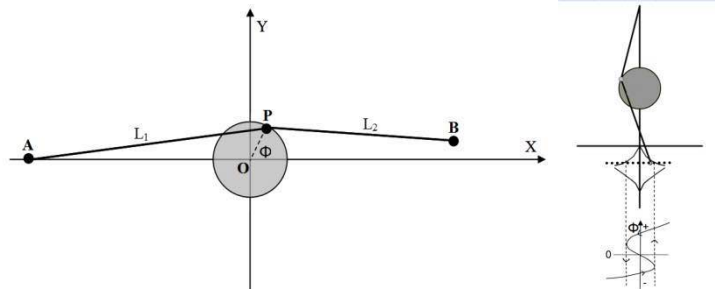

Figure 1. (a) Zeeman's catastrophe machine (b) Bifurcation area and hysteresis

Let's study the behaviour of the system by slowly moving the end B of the L_2 rubber string parallel to the y-axis towards the X-axis starting from different $B(X_0, Y_0)$ points. In most cases, we find that the position of the end B clearly defines the Φ angle, which changes constantly as B is moved. By nearing the string end B towards the X-axis, then crossing it and moving away from it in the opposite direction, the absolute value of Φ decreases, changes sign when crossing the axis and increases while moving away from it. However, a strange area bounded by four curved lines, which can be well designated experimentally, constitutes an exception. At any internal point of this area, the sign of the angle Φ which belongs to the equilibrium can be either positive or negative. This area is called *bifurcation area* (figure 1(b)). The experiments show that in the bifurcation area, the change in the angle determining the equilibrium is direction-dependent according to the movement of the point B , the change happens differently when going from right to left than in the other way around. The change in the angle exhibits *hysteresis*. Hysteresis is an essential feature in the behaviour of nonlinear systems.

To begin the use of the Dynamics Solver let us start the `#zeeman_animation.ds` simulation file. The theoretical background of the Zeeman catastrophe machine and a suggested way for the use of the simulation can be found in the reading file `#1_prologue_Zeeman_catastrophe-machine.pdf`.

3. Dissipative chaos

In catastrophe theory, we study the quasi-static properties of the Zeeman Machine and the abrupt changes in its equilibrium state [9]. However, the dynamics of the machine moving due to an external force also produce results showing very interesting chaotic properties [10].

The equation of motion of the Zeeman Machine can be derived from the Lagrangian equation [11]. The phase space of the system is only two-dimensional (with the variables angle and angular velocity), which is known to be too "tight" for the chaotic motion to emerge. Much more interesting type of motion can be created if a periodic driving force is applied at the $B(X, Y)$ end of the second rubber string. The excitation of the system has been investigated using a driving force of period T_p applied at the B end of the second string

(we define $\Theta = \frac{2\pi}{T_p} t$ phase variable of driving). The dissipative system described by these equations starting

from arbitrary initial condition (Φ_0, ω_0) will reach an equilibrium position due to the continuous energy loss. Henceforth each quantities with dimension of length will be expressed with the R radius of the disc, that is dimensionless variables denoted by lowercase letters will be used:

$A = a \cdot R$, $X = x \cdot R$, $Y = y \cdot R$, $L_0 = l_0 \cdot R$, $L_1 = l_1 \cdot R$, $L_2 = l_2 \cdot R$, and $c = \frac{I \cdot R^2 \cdot k}{\gamma^2}$ is a dimensionless

parameter. The introduction of the periodic driving force increases dimension of the phase space from two to three, and as it is well known in systems with three dimensional phase space chaotic motion can be occurred. As we show in Appendix of the #2_dissipative_chaos.pdf the equations of motion are:

$$\begin{cases} \frac{d\Phi}{dt} = f_1(\Phi, \omega, \Theta) = \omega \\ \frac{d\omega}{dt} = f_2(\Phi, \omega, \Theta) = \\ = c \cdot \left[\frac{(l_1 - l_0)}{l_1} \cdot a \cdot \sin \Phi + \frac{(l_2(\Theta) - l_0)}{l_2(\Theta)} \cdot (y(\Theta) \cdot \cos \Phi - x(\Theta) \cdot \sin \Phi) \right] - \omega \\ \frac{d\Theta}{dt} = f_3(\Phi, \omega, \Theta) = \frac{2\pi}{T_p} \end{cases} \quad (1)$$

$$\text{where: } \begin{cases} l_1 = \sqrt{(\cos \Phi + a)^2 + (\sin \Phi)^2} \\ l_2(\Theta) = \sqrt{(x(\Theta) - \cos \Phi)^2 + (y(\Theta) - \sin \Phi)^2} \end{cases} ,$$

and where the angular velocity $\omega = d\Phi/dt$.

As it was mentioned earlier the **B** end of the second rubber string undergoes simple harmonic motion in the direction of the *Y* axis with a centre at $(x_0, 0)$ point. The period and amplitude are T_p , and y_0 , respectively. It means that in equations (1) the variables of $x(\Theta)$ and $y(\Theta)$, should be replaced by x_0 and $y_0 \cdot \sin(\Theta)$, respectively. The system was investigated at $c=10$; $a=6$; $l_0=3$; $y_0=0.6$; $T_p=3$ fixed parameters as a function of the x_0 control parameter.

The bifurcation diagram of the system and the trajectories in the phase space can be displayed by simulation files `#harmonically_driven_zeeman_bifurcation_diagram.ds` and `#harmonically_driven_zeeman_phase_space.ds`, respectively. The suggested way for the use of the simulations can be found in the reading file #2_dissipative_chaos.pdf.

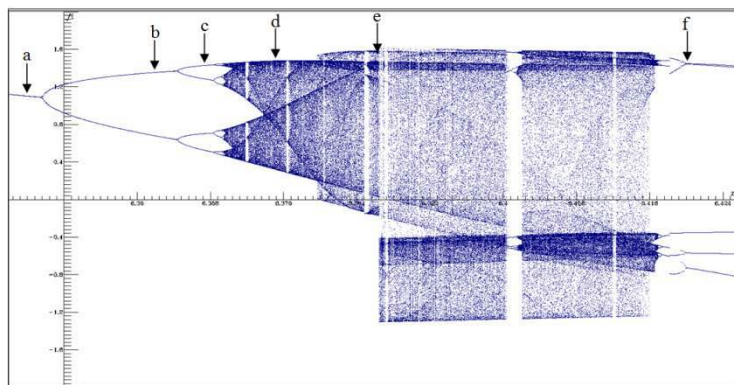

Figure 2: The bifurcation diagram of the system with $(\Phi_0 = 0, \omega_0 = 0, \Theta_0 = 0)$

The bifurcation map shown in figure 2 is a typical example for that of chaotic systems. The sequence denoted by **a** corresponds to a limit cycle consisting of only one point on the stroboscopic map. The sequence denoted by **b** represents a limit cycle consisting of two points on the stroboscopic map; range **c** represents a four point limit cycle and so on. The development of such type of bifurcation series is a typical precursor of the chaotic behaviour. Bifurcation diagram at **d** and **e** refers to a chaotic zone of motion belonging to the control parameters given. Without going in the details of the chaotic zone it is only mentioned that the chaotic zone is a finite one and after it the periodic behaviour appears again (**f**).

Using the bifurcation diagram we can find proper values of the control parameter where the trajectories are worth depicting. The diagrams in figure 3 show the trajectories in the $\Phi - \omega$ phase plane, and are labelled by the same letters as the corresponding regions of the bifurcation diagram in figure 2.

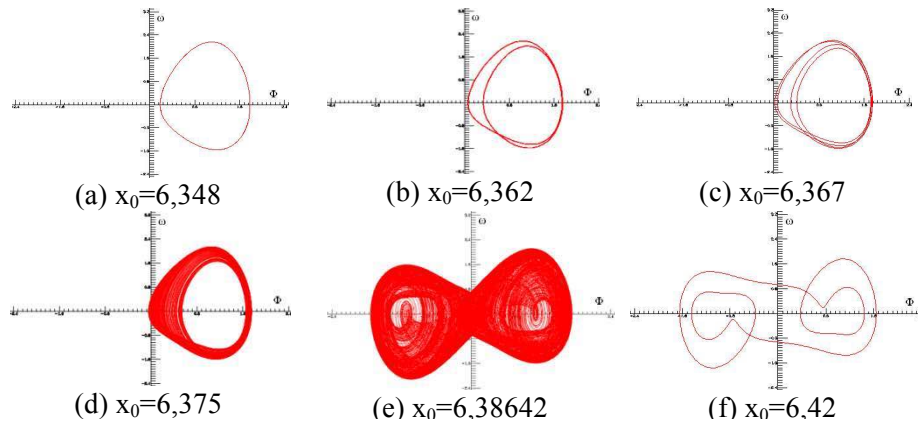

Figure 3: The trajectories of motion in phase plane with $(\Phi_0 = 0, \omega_0 = 0, \Theta_0 = 0)$

Figure 3 shows a very strange and important feature of the motion of the Zeeman Machine. Attractors shown in figure 3(e) and 3(f) are centrally symmetric to the origin of the $\Phi - \omega$ phase plane, while those represented in Fig. 3(a)-3(d) are not. The Zeeman Machine itself has also a symmetry axis (the X axis in figure 1) and its equation of motion also holds this symmetry consequently equation (1) is invariant to the change of the variables of $\Phi \rightarrow -\Phi$, $y \rightarrow -y$ and $\omega \rightarrow -\omega$. It is very strange that there are equilibrium positions of the system which do not keep the symmetry of the equation of motion. This behaviour is called *spontaneous symmetry breaking*. This is one of the most exciting phenomena of modern physics, inter alia, it is the basis of the Higgs mechanism by which the mass of the elementary particles in the standard model is interpreted [12][13]. The symmetry breaking and the Psychological conditioning give an obvious possibility for the manipulation of our brain. On website [14] there is a spinning-cat animation, which can be seen rotate clockwise or anticlockwise randomly. Video #yym_manip.avi [15] presents a brilliant and amusing example of how our brain can be governed with symmetry breaking to form a predetermined opinion in an important question.

A more exact picture of the chaotic attractor can be obtained by applying a stroboscopic mapping with using #harmonically_driven_zeeman_stroboscopic.ds (the suggested way for the use of the simulation can be found in the reading file #2_dissipative_chaos.pdf).

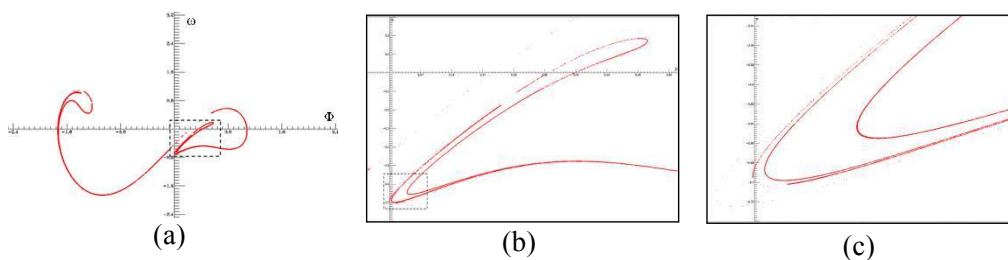

Figure 4: The fractal-structure of chaotic attractor ($x_0=6,38642$)

Figure 4 shows stroboscopic representation of the attractor exhibited in figure 3(e) at $\phi_s=0$. In figure 4(b) and 4(c) the magnification of the territory bordered by dashed line in figure 4(a), and 4(b), can be seen, respectively (the procedure of the magnification can be found #ds_brief_tutorial.pdf file of the folder Tools of our electronic material). These diagrams demonstrate perfectly the *scale property* of the chaotic attractor and show its *Cantor fiber*-like structure.

The sensitivity of the time evolution of a system on the initial conditions is also investigated customarily in chaotic systems. To study this effect let's start a system with different but very close initial values and follow the deviation of the trajectories. This study can be visualized by the *phase drop methods*.

In figure 5(a) and 5(b) the position of 10000 neighbouring phase points located initially in a square domain of size 0.01 around the origin of the $\Phi - \omega$ plane can be seen after 30 and 300 time steps, respectively (the control parameter is $x_0=6,38642$). This phenomenon can be investigated by program *#harmonically_driven_zeeman_phase_domain.ds* (the suggested way for the use of the simulation can be found in the reading file *#2_dissipative_chaos.pdf*).

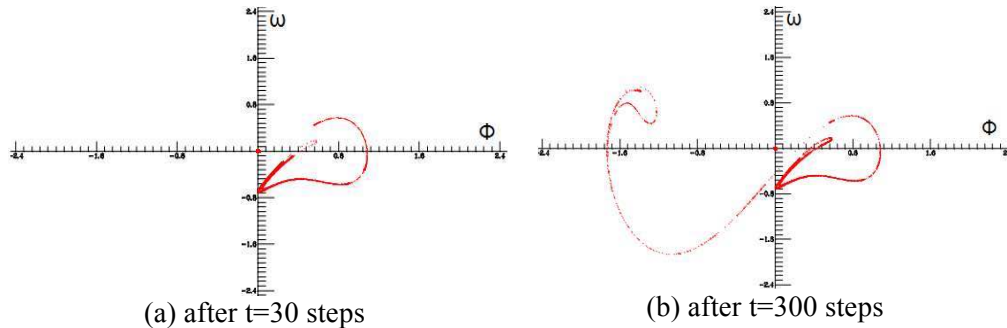

Figure 5: Deviation of 10000 neighbouring phase points ($x_0=6,38642$)

It is well observable that points which are originally of immediate vicinity of each other are diverging very quickly. The small initial ‘phase drop’ (phase domain) spreads out strongly already after 30 time steps, and after 300 time steps it covers essentially the whole chaotic attractor.

Edward Lorenz expressed this extreme sensitivity with an example taken from meteorology. His famous question: “Does the flap of a butterfly's wings in Brazil set off a tornado in Texas?” was a title one of his lectures in 1972. This question led to name the extreme sensitivity of a system on initial conditions as butterfly effect, which is a very equivocal and remiss notion. The video *#butterfly-effect_Lorenz.flv* [16] shows the butterfly effect in the famous Lorenz model, while video *#butterfly-effect_parody.mov* [17] gives a caricature of this frequently cited effect.

4. Transient chaos

Permanent chaos studied in the previous chapter can exist for an arbitrarily long time period. Contrast to it transient chaos is interim chaotic motion occurring at finite time interval after which the motion becomes periodic. Of course in case of transient chaos chaotic attractors do not exist but a non attracting chaotic saddle can be found which has zero measure and which can be approached arbitrarily closely by trajectories. Trajectories can permanently stay at its neighbour. Chaotic saddle is embodied by those trajectories which exhibit chaotic behaviour for a relatively long time. The basic new feature here is the finite lifetime of chaos. The theoretical background and a suggested way for the use of the simulation files can be found in the reading file *#3_transient_chaos.pdf*. Figure 6 shows the trajectory of the system. In figure 6(a) the first 5200 time steps, in figure 6(b) the second 5200 ones can be seen. It can be observed that at the first stage the motion is chaotic, but at the later second stage it is periodic. It means that the motion of these parameter exhibits the transient chaos.

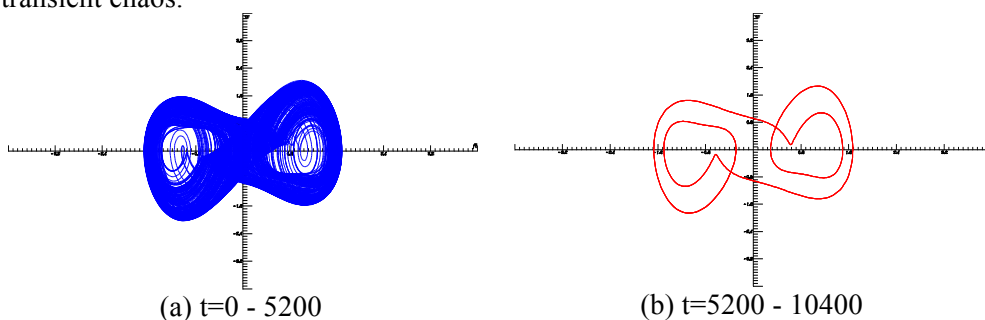

Figure 6: The transient chaos

Figure 6(b) clearly shows a limit cycle (closed curve), but what is the order of it? The stroboscopic map reflects a more demonstrative way these features of the motion: an n -cycle appears as a set of n distinct

points mapped onto each other, and each one returns to its initial position after n steps. Stroboscopic map of the first stage of the motion outlines almost perfectly the chaotic attractor, while subsequent stage displays five discrete points corresponding to a five-cycle motion (see Figure 7).

The stroboscopic pictures can be investigated with the file `#harmonically_driven_zeeman_transient_strob.ds` (a suggested way for the use of the simulation files can be found in the reading file `#3_transient_chaos.pdf`.)

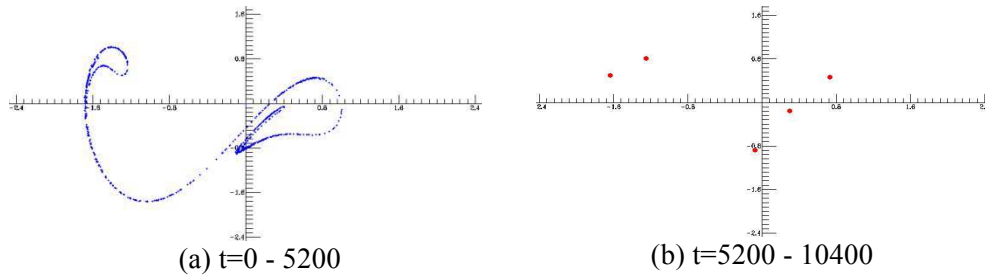

Figure 7: Stroboscopic map of the transient chaos

5. Conservative chaos

Zeeman machine discussed in previous chapters is a dissipative system so it is not appropriate for studying the chaotic behaviour of *conservative systems*. Although the original version of the Zeeman machine is frictionless and therefore conserves the energy its two dimensional phase space is not wide enough to produce chaotic motion. An external driving force had to be introduced to increase the number of dimension of the system. However, it seems to be a plausible idea, it is still a novelty, to use *coupled Zeeman machines* for the investigation of chaotic behaviour of conservative systems. Figure 8 shows two coupled frictionless Zeeman Machines which forms a conservative system with four dimension phase space.

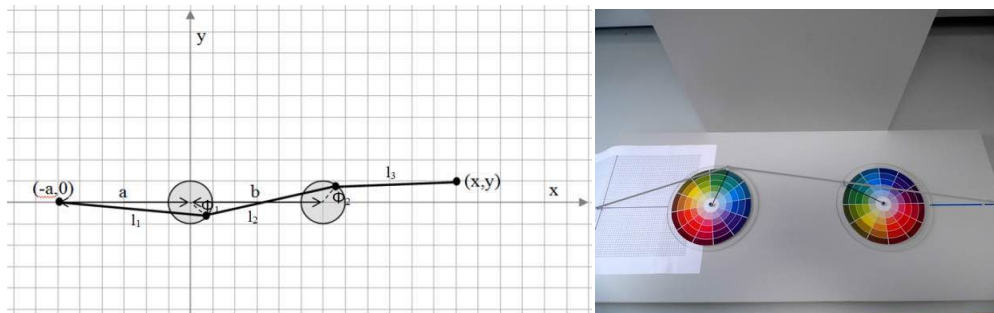

Figure 8: The coupled Zeeman Machines

The theoretical background of the coupled Zeeman catastrophe machines and a suggested way for the use of the simulation files can be found in the reading file `#4_conservative_chaos.pdf`.

In conservative systems there are no attractors the character of motion depends on the initial conditions [4].

In order to get an overview of the system’s behaviour Poincaré maps belonging to the same energy, but corresponding to different initial conditions should be plotted. From the four initial conditions $(\Phi_{10}, \Phi_{20}, \omega_{10}, \omega_{20})$ only three can be chosen freely, the fourth one should be determined from the

expression of the energy $e = \omega_1^2 + \omega_2^2 + (l_1 - l_0)^2 + (l_2 - l_0)^2 + (l_3 - l_0)^2$, where the sum of the kinetic and potential energy e scaled in units of $\frac{1}{2} kR^2$.

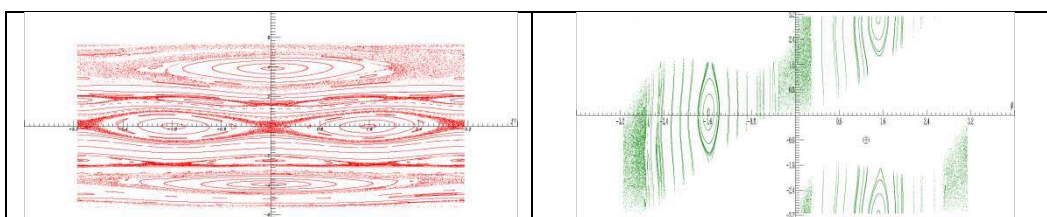

(a) Phase plane $\Phi_1 - \omega_1$	(b) Phase plane $\Phi_1 - \Phi_2$
-------------------------------------	-----------------------------------

Figure 9: Poincaré-maps with $(l_0 = 3, a = 6, b = 6)$, $(x = 12, y = 1)$ and energy $e=60$

In figure 9 Poincaré maps of the motion are shown on the $\Phi_1 - \omega_1$ and $\Phi_1 - \Phi_2$ phase planes at a given energy value. The maps are representing well the *conservative chaos* and they show *fat fractal* like big chaotic areas with *periodic isles* in them.

6. Conclusion

It was demonstrated that in spite of its simplicity the Zeeman Catastrophe Machine can be a versatile and motivating tool for students to get introductory knowledge about chaotic motion via interactive simulations. Studying the dynamics of the machine a broad range of characteristics of chaotic motion can be covered which generally needs the discussion of several different systems. The work is organically linked to our website [1] where the electronic materials (reading PDF files, simulation programs and videos) could be freely downloaded.

References

- [1] <http://csodafizika.hu/zc>
- [2] Nagy, P., Tasnádi, P.: Zeeman Catastrophe Machines as a toolkit for teaching chaos, European Journal of Physics, Paper 015018. 22 pp (2014)
- [3] <http://tp.lc.ehu.es/jma/ds/ds.html>
- [4] T. Tél, M. Gruiz: Chaotic Dynamics, An introduction based on classical mechanics, Cambridge University Press, Cambridge, 2006
- [5] Korsch, H. J. and Jodl, H.-J. Chaos – A Program Collection for the PC, Berlin, Springer, 1998.
- [6] Gutzwiller, M. C. Chaos in Classical and Quantum Mechanics, Berlin, Springer, 1990.
- [7] Szemplinska-Stupnicka, W. Chaos, Bifurcations and Fractals around Us., Singapore: World Scientific, 2003.
- [8] <http://www.math.sunysb.edu/~tony/whatsnew/column/catastrophe-0600/cusp4.html>
- [9] <http://l.d.v.dujardin.pagesperso-orange.fr/ct/cusp.html>
- [10] Litherland, T. J. and Siahmakoun, A. Chaotic Behaviour of the Zeeman Catastrophe Machine, Am. J. Phys. 63(5), May 1995, 426-431.
- [11] L.D. Landau, E.M. Lifshitz: Mechanics. Vol. 1 (3rd ed.), Course of Theoretical Physics. Butterworth–Heinemann, 1976
- [12] <http://www.nhn.ou.edu/~cbertsch/statmech/higgsasising.pdf>
- [13] <http://www.laspp.cornell.edu/sethna/OrderParameters/>
- [14] <http://jaced.com/2010/10/01/spinning-cat-illusion/>
- [15] http://indavideo.hu/video/Mind_manipulation
- [16] <http://www.youtube.com/watch?v=FD2GdjWUkuc>
- [17] <http://www.youtube.com/watch?v=1YzvbmmJiOc>

Affiliation and address information

Peter Nagy
 Department of Natural Sciences and Engineering
 Kecskemét College, Izsáki u. 10.
 6000 Kecskemét, Hungary
 e-mail: nagy.peter@gamf.kefo.hu

Peter Tasnádi
Faculty of Science
Eötvös Loránd University
Pázmány Péter sétány 1/A
1117 Budapest, Hungary
e-mail: tasnadi.peter.jozsef@gmail.com

Assessment of Student Constructed Models on Topics Relevant to Heat and Temperature Systems

Christiana Th. Nicolaou¹, Bert Bredeweg², Constantinos P. Constantinou¹,
Jochem Liem²

¹ University of Cyprus,

² University of Amsterdam

Abstract

Methods for assessing conceptual models are sparse and this hampers the use of modelling as an instrument for teaching and learning. In this paper we present and use two methods for assessing conceptual models: the Modelling Practices-based Assessment Method (method 1) and the Criterion Referenced Artifact Analysis (method 2). Both methods have been successfully applied to learner constructed models which resulted from the implementation of an evaluation study. Students were called to construct successive models to explain how two objects with different mass and temperature behave when in contact. Students used the DynaLearn Interactive Learning Environment to build their models. We present an analysis of the two successive models, constructed by a specific group of students, as resulted by the use of the two methods. Then, the overall results regarding all student constructed models are presented. Our results indicate the importance of the two methods and the need to use them complementary. Method 1 is detailed and precise, resulting a numerical grade, while Method 2 has an overarching flavor, delivering a ranked list of learners' models according to performance.

Keywords:

Learning by modelling; Conceptual models; Assessment

1. Introduction

Learning by modelling has been acknowledged by scholars as a way to promote conceptual understanding (Crawford & Cullin, 2004) and help learners gain expertise in all modelling practices (construct, revise, compare, evaluate and validate models) (NRC, 2012). Learning by modelling is considered to be a challenge for many teachers, and if they are expected to introduce learning by modelling in their teaching practice, there is the need to establish both appropriate curriculum and methods for assessing learners constructed models.

A model is an external representation, which provides an interpretation of a phenomenon or system, that can be used for predicting future behaviors of the system (Bunge, 1983). The model's representational quality is an amalgam of its constituent components, i.e. objects, variable quantities, processes and relationships. The model's interpretive potential relates to its efficiency in providing an interpretation, which includes one or more mechanisms that explain the behavior of the phenomenon. Finally, a model has predictive power when it allows the formulation and testing of predictions for new manifestations of the phenomenon it represents.

Learning by modelling refers to learning through the actual construction and revision of models by learners (Crawford & Cullin, 2004; Schwarz, et al., 2009) and is different from learning with models (De Jong, et al., 2005). The latter concerns learners *using* already constructed models aiming to gain insight in the phenomenon represented by the model. In contrast, the learning by modelling concerns the *construction* of interpretive representations with predictive power. When learning by modelling entails the construction of conceptual models it is called conceptual modelling, and focuses on representing the continuous properties of systems, such as quantities, space and time, and emphasizing qualitative distinctions. In contrast to constructing mathematical models, qualitative reasoning relates to the conceptual analysis of a system's behavior, including notions such as causality (Bredeweg & Forbus, 2003). As such, qualitative modelling constitutes a way to implement conceptual modelling, and, therefore, learning by modelling.

The DynaLearn Interactive Learning Environment (Bredeweg, et al., 2013) enables learners to create conceptual models by working through several stages of representation (referred to as Learning Spaces) from specifying and interpreting simple, static concept maps at the lowest level (#1), to complex dynamic models with advanced representations for capturing causality at the highest level (#6). The learners in the study reported on this paper used Learning Space 4 (Liem, 2013).

An important part of assessing the modelling competence pertains to the evaluation of the learner constructed models. Despite the growing research interest in applying the learning by modelling approach, research efforts to assess the modelling product (i.e. learner constructed models) are sparse (Louca, et al., 2011). Our research works towards addressing this omission. Particularly, by investigating “How the quality of learner constructed conceptual models can be assessed?” This paper presents two approaches for assessing learner constructed models, and the application of these approaches to a real-world case.

2. Assessment Methods

Assessment method 1: Modelling Practices-based Assessment

Liem (2013) proposes a framework that enables a partial objective evaluation of conceptual models. Thirty-six modelling error types were identified, and include both checks to detect such errors and modelling actions to ameliorate them. Each of these errors effects one or more of the model features that contribute to the quality of a model. Two categories of model features are distinguished. First, *language-based features* can be assessed using the internal logic of the language that is used to represent the model. For example, the consistency feature indicates that no model ingredients should contradict each other. Second, *domain-representation-based features* rely on human interpretation of the model. For example, the conformance to ontological commitments feature requires that a referent in the domain is represented using the correct term in the language (e.g. biomass should be shown as a quantity and not as an entity).

The modelling errors are used to develop quality measures covering all relevant aspects of a conceptual model, and a metric that reflects a model’s overall quality. The framework distinguishes three main categories that determine a model’s overall quality:

- Verification based on model errors constitutes 50% of the metric. This is subcategorized based on the different aspects of the modelling language that modellers need to learn to represent: Structure (10%), Quantities (5%), Quantity spaces (5%), Causality (10%), Inequalities and correspondences (10%), and Simulations (10%)
- The model’s communicative value constitutes 25% of the metric and it is based on two factors: Quality of the layout (5%), and Documentation accompanying the model (20%)
- The adequacy of the model as a domain representation to fulfill a certain goal determines 25% of the metric. The validation categories are subjective and rely on the expertise of the evaluator to assess: Correctness (10%), Completeness (10%), and Parsimony (5%).

Assessment Method 2: Criterion Referenced Artifact Analysis

This method draws from the principles of artifacts’ analysis (LeCompte & Preissle, 1993). Each artifact, here the model, is analyzed with respect to its representation, interpretive, and predictive feature.

To evaluate a model’s *representational quality* its components are be assessed. Objects, variable quantities, processes and relations are the four elements of a good model. *Objects* constitute the core components of a model and are characterized by specific changing aspects, the *variable quantities*. *Processes* are usually series of occurrences that produce change. Finally, relations are all the inter-relationships between the other three model components. To analyze the representation feature of a model, all relevant model components are identified. The model receives score 0 for objects if none of the expected objects are represented. It receives a score 1 if only part some objects are not included and it receives a score 2 if all objects are represented. The same process is implemented for the other three model components as well as the following model features (interpretation and prediction). The model’s *interpretive feature* relates to the models efficiency in providing an interpretation, which presumes one or more mechanisms that explain the behavior of a phenomenon. The interpretive feature of a model is assessed on the basis of its capability to present the story behind the phenomenon. This story should explain why the observable behavior of the model occurs. A model has *predictive power* when it allows the formulation and testing of predictions for new aspects of the phenomenon it represents. Therefore, a constructed model should allow any of its elements to be changed and the resulting changes in the behavior of the phenomenon to be observed.

After assigning the scores for each feature, the models are grouped in levels according to their common codes in scoring. As a result different levels of learner attainment in constructing models are formed and ranked with respect to their scientific correctness.

3. Methodology

The participants, 17 high-school learners (15-17 years old, 5 girls and 12 boys) constructed conceptual models using the Dynalearn modelling tool (<http://www.DynaLearn.eu>). Learners worked in small groups (5 groups of 3 learners and 1 group of 2 learners). The intervention was implemented using a period of 7 ninety minutes lessons (figure 1). During each of the two modelling based learning cycles students (a) constructed a model and filled out the accompanying model coding form, and (b) evaluated the model of another group including filling out a model assessment form.

Learners were given data of a set of experiments that showed what happened to two cubes of the same mass but with different temperatures when they were brought into contact with each other. The data pointed to the idea that “the final temperatures of the two cubes are equal” and that the hotter cube “loses an amount of temperature”, which is received by the colder cube. Therefore, an acceptable (though not scientifically) correct explanation for the given data is that “the temperature lost from the hotter cube is received by the colder cube”. While working with DynaLearn, learners are expected to develop and acquire a version of this explanation by constructing it in their initial (naive) model. The second set of data concerned experiments where two bodies with different temperatures and different masses make contact. The first model does not account for this and therefore the need to revise that model emerges. What is now considered to flow between the two cubes, through the medium, is not the temperature, but heat, which then causes an increase of the temperature of the colder cube and a decrease of the temperature of the hotter cube. Learners are expected to acquire this insight by constructing a more advanced version of their initial model.

The models created by the learners constitute an important part of the data collected to be processed by the two assessment methods. From the six groups each constructed two successive models (naive and advanced); one for each data set, and 24 accompanying documents (model coding and model assessment forms). Both the models and the forms were collected and analyzed. Analysis of the 12 models was performed by applying the two assessment methods presented above.

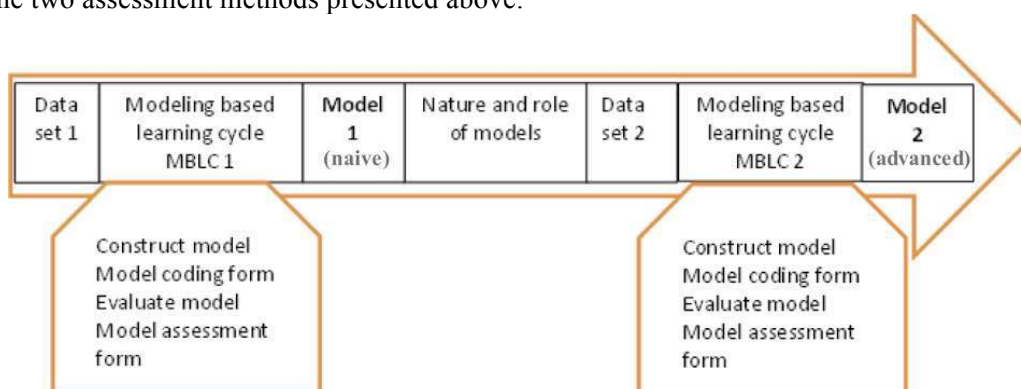

Figure 1. Schema of the learning intervention

4. Results

Qualitative analysis of a naive model: Method 1

Figure 2 shows the naive model constructed by group 4. This model includes three entities, the cold cube, the hot cube and the medium. Correct modelling practice requires that the two cubes are connected with structural relations (referred to as configurations in DynaLearn) via the medium. However, the modellers have ignored this relation and directly connected the two cubes, hence two structure errors [error #29 in (Liem, 2013)]. As a result the assessment for the structure becomes $[(3+1-2)/(3+1)*10]$ yielding a score of 5 (the multiplication by 10 indicates the weight assigned to the structure). The model has no errors regarding Quantities, Quantity spaces, Causality, Inequalities and Correspondences.

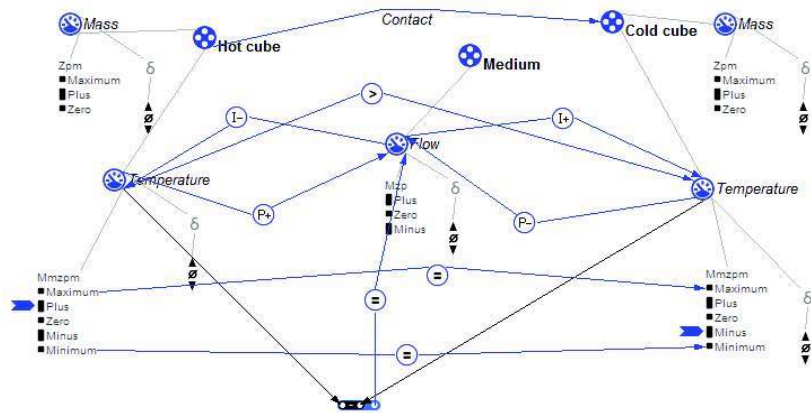

Figure 2. Naïve model constructed by group 4

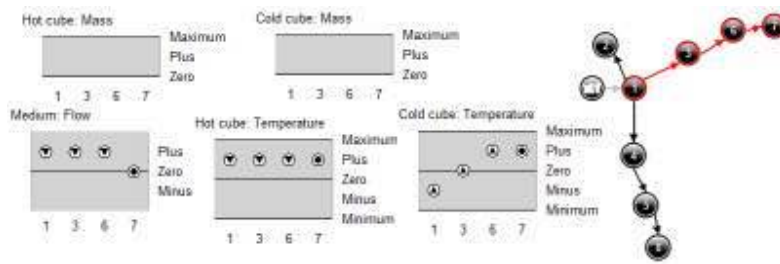

Figure 3. Simulation results for the model shown in Figure 2

The simulation of this model reveals three different paths ($[1 \rightarrow 2]$, $[1 \rightarrow 3 \rightarrow 6 \rightarrow 7]$ and $[1 \rightarrow 4 \rightarrow 5 \rightarrow 8]$, right part of figure 3). The graphs generated by the DynaLearn software (left part of figure 3) concern the evolution of each of the model's quantities. There are eight items for which no information is provided (hot cube: mass, and cold cube: mass). When all paths are taken into account, a total of 16 problematic issues emerge (error # 32, Liem, 2013). Therefore, the model receives 0 for the simulation $[(8-16)/8]$. The model is complete (10) but not completely parsimonious (8.33), as it includes two quantities that are not really part of the model, as they are not connected to any other quantity (hot cube: mass, and cold cube: mass). Additionally, it is not fully correct (8.89), as the quantity space of Temperature is incorrect $[(18-2)/18*10]$, where 18 represents all the models elements and two the aforementioned errors. Finally, the model's layout is reasonable and well described. Hence the model receives 5 points for layout. The model's communication value is assessed through a document filled in by the students in which they reported how their model represents the phenomenon (score=0.78), how it explains the phenomenon (score=0) and how it helps us predict the future evolution of the phenomenon (score=0). This model received a score of 5.2 for documentation. Again, the multiplication with 20 yields the weight assigned to communication. When all subscores are taken into account, the total score of this model is 68.3.

Qualitative analysis of a naive model: Method 2

The same model was analysed following the criteria of the second assessment method (representation, interpretation and prediction). The model's *representation* refers to how the model includes objects, variable quantities, processes and relations. The group inserted all necessary objects, the two cubes and the medium, all necessary variables (the temperature of each cube), but they also included some unnecessary variables (mass for each cube). Flow is the process of the model. Additionally, all relations included between the variables are correct (a. flow is the difference between the two temperatures, b. if flow exists then Temperature of the hot cube decreases and this decreases flow, and c. if flow exists then Temperature of the cold cube increases and this decreases flow). Therefore, the total representation of the model is considered as strong. With regards to the *interpretation*, this model seems to include the following mechanism: "Due to difference in starting temperatures there is a flow of temperature. This flow influences both the temperature of the hot cube (I+ and the temperature of the cold cube (I+). Temperature of the hot cube positively affects flow (P+) while Temperature of the cold cube negatively affects flow (P-). This is a sound mechanism and it is therefore assessed as having a strong interpretation. Finally, the model allows for *making predictions* since one can change the starting values of both temperatures and observe the subsequent evolution of the

phenomenon. However, no information is provided about the mass variables, and therefore, the model’s predictive power is considered as moderate.

Qualitative analysis of an advanced model: Modelling Practices-based Assessment

When the students of group 4 were asked to improve their model based on the new data and on the evaluation they received from peers (see figure 1), a more advanced model emerged (figure 4). Just like their naive model, this model also contains 3 entities, the cold cube, the hot cube and medium. It is expected that the two cubes are connected with configurations through the medium. However, the modellers ignore this relation and connect directly the two cubes, hence two structure errors [error #29 in (Liem, 2013)]. As a result the equation for the structure becomes $[(3+1-2)/(3+1)*10]$ and yields a score of 5 (the multiplication by 10 indicates the weight assigned to the structure). The model includes no errors with regards to the rest of the modelling guidelines.

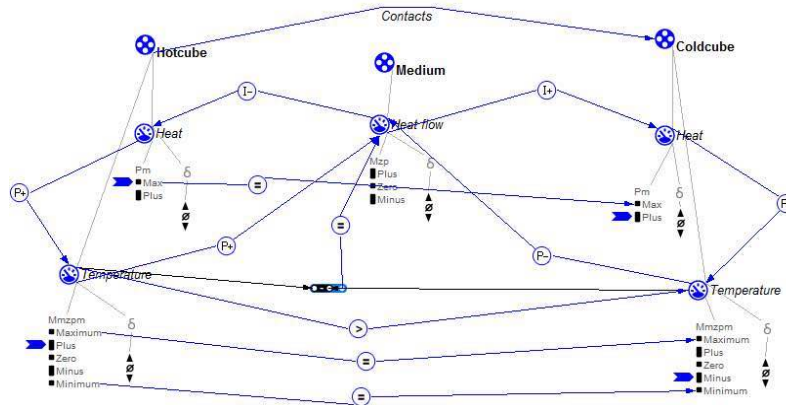

Figure 4. Screenshot of model 2 constructed by group 4

The graphs in Figure 5 pertain to the evolution of each of the model’s variable quantities. The information presented by the graphs is correct for all items; there are no problematic issues and equilibrium is reached (both temperatures have minus values). The model is complete (10) parsimonious (10), and correct (10). The model’s layout is reasonable and well described. Hence the model received 5 points for layout. The description of the model’s representational, interpretational, and predictive power are well described in the accompanying document, hence $[(3/3+5/5+1+1)/4+0,8+1]/3*20$. The only deficiency in the description concerns its mechanism, where this group of students didn’t clearly describe how heat influences flow. “The difference in temperatures creates flow. This flow influences heat and heat influences temperature. The temperature of the cold will increase and the temperature of the hot will decrease. The equilibrium is reached.” Therefore, the total documentation score is 9.33. Again, the multiplication with 20 yields the weight assigned to communication. When all subscores are taken into consideration, the total score of this model is 93.7.

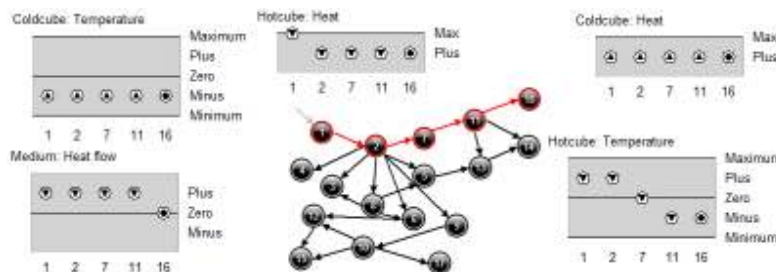

Figure 5. Simulation results of the model shown in figure 4

Qualitative analysis of an advanced model: Criterion Referenced Artifact Analysis

When we analysed this model using method 2, it received a full score for all model features, representation, interpretation and prediction. With regards to *representation*, it includes all necessary objects, the two cubes and the medium, all necessary variables (the temperature of each cube) and no unnecessary variables. Flow is the process of the model. Additionally, all relations included between the variables are correct (a. flow is the difference between the two temperatures, b. if flow exists then heat of the hot cube decreases and this

decreases its temperature, and c. if flow exists then Heat of the cold cube increases and this decreases flow). Therefore, the model's representation is strong. With regards to the *interpretation*, this model seems to include the following mechanism: "Due to difference in starting temperatures there is a flow of heat. This flow influences positively (I+) the heat of the cold cube and negatively (I-) the heat of the hot cube. Both heat of the cold and the hot cube affects positively the temperature of the cold and the hot cube respectively (P+). Then the temperature of the hot cube positively affects the flow and the temperature of the cold cube negatively affects the flow". This is a sound mechanism, and therefore the model's interpretation is considered strong. Finally, the model allows for making predictions since one can change the starting values of both temperatures and observe the subsequent evolution of the phenomenon, and therefore the model's predictive power is also strong.

Overall results of the analysis with the two assessment methods

Table 1 summarizes the analysis conducted using method 1. This assessment method allowed for ranking the 12 models according to their performance based on numerical grades. When comparing the naive models, group 1 received the best score and group 5 constructed the least scientific model. When comparing the advanced models, this ranking changed, and group 4 climbed to the first place while group 1 dropped to the last one.

Table 1. Results of the analysis based on assessment method 1

Modelling guidelines				
Model	Model Errors(50%)	Model Adequacy(25%)	Comm.value(25%)	Total score
m1g1*	35,8	21,8	23,5	81,1
m1g3	42,6	23,4	14,4	80,4
m1g2	38,3	22,9	9,8	71
m1g4	35	23,1	10,2	68,3
m1g6	30,8	22,9	9,8	63,5
m1g5	17,5	19,6	17,2	54,3
m2g4	45	25	23,7	93,7
m2g2	42,6	22,1	16,6	81,4
m2g6	40	22,8	17,4	80,1
m2g3	41,1	22,7	13,8	77,6
m2g5	38,5	23	15	76,5
m2g1	33,3	22,2	8,8	64,3

*m1g1 = model 1 of group 1, m1g2 = model 1 of group 2, etc

Table 2. Levels of learners' competence to construct models (based on method 2)

Level	Description	naïve model	advanced model
6	Models entail strong representational, interpretational and predictive power	m1g3	m2g2,m2g5, m2g6, m3g4
5	Models entail strong representational and interpretational power and moderate predictive capability	m1g4	m2g3
4	Models entail moderated representational, low interpretational and strong predictive power	m1g6, m1g2	m2g4
3	Models entail moderated representational, low interpretational and moderate predictive power	-	m2g1
2	Models entail moderated representational, low interpretational and low prediction power	m1g1	-
1	Models entail low representational, interpretational and prediction power	m1g5	-

Table 2 summarizes the analysis using method 2. Models at level 6 adhere to the characteristics as required for scientifically acceptable models and the model of level 1 is far from the scientifically acceptable baseline. Learner constructed models at level 1 have low representational, interpretational and predictive power. On the contrary, learner constructed models categorized at level 6 have strong representational, interpretational

and predictive power. Table 2 shows that learner constructed models move from the lower levels to the upper ones. For example, model 1 of group 5 (m1g5) is labeled as level 1, and model 2 of the same group (m2g5) is labeled as level 6. This is an indication that learners became better in constructing models.

5. Conclusion and Discussion

Methods for assessing conceptual models are sparse. This hampers the use of modelling as a tool for education. We presented two methods for assessing conceptual models. These methods are new and relevant to the scientific area of model assessment. The assessment methods can be used by teachers who implement modelling-based instruction in the classroom, in principle at any educational level. Method 1 is detailed, precise, and results in numerical grades, while method 2 has an overarching flavor, delivering a ranked list of learners' competence according to performance. Method 2 is less strict and can be applied to more modelling languages (e.g. conceptual modelling, numerical modelling, or object oriented modelling) given the fact that the evaluator captures the essence of these languages. However, an additional step is needed by the evaluator who has to gain an understanding of the specific modelling language used. Method 1, on the other hand is more specific, and helps the evaluator arrive at a specific score for different aspects of the model (and one aggregated score). However, its applicability is less extensive, since it can only be applied to qualitative reasoning models. Both methods have been successfully applied to a real-world case and have generated relevant outcomes. Finally, despite being different in approach and content, the two methods align in the sense that they generate approximately the same ranking among models in terms of the modelling aspect of the model quality, although, the specifics taken into account in method 1 (and not in method 2) do allow for some variation.

The data presented here indicate that the two methods used were successful in capturing the differences between different learner models as well as between the subcategories of each assessment method. When comparing learner constructed models, the first assessment method indicated that learners improved their score in the knowledge representation aspect and got worse in communicating the model to others. Additionally, the second assessment method indicated that learners also improved their models' adequacy in representing the phenomenon. Both assessment methods indicated that the advanced learner constructed models gained better scores compared to the naive ones for all modelling aspects, indicating that the instruction was successful in promoting the development of the modelling competence. However, it is important to state that these conclusions are only qualitative in nature, since the small number of the sample does not allow for statistical comparison.

It appears that for some criteria the two assessment methods do not differentiate well between models. For instance, using method 1 all models score 5 on the quantity spaces criteria. Should this be considered a problem? Probably not, as it turns out that in the case of the assignments used in this study, the definition of quantity spaces was relatively simple. Hence, it is not a surprise that learners handled this model feature correctly. To circumvent having such easy and non-discriminating criteria, an evaluator can impose two solutions. One option is simply to not include the criterion, and increase the percentages of the other criteria to accumulate to 100%. Alternatively, an evaluator can decide to only reduce the percentage of such a criterion (and not completely remove). This issue is also valid for the predictive feature of the method 2, where models received score 2, because DynaLearn is a modelling tool that helps towards this direction. By constructing any variable quantity in a model, DynaLearn allows for changing its initial value and check the simulation results, therefore, it easily allows for making predictions. Consequently, evaluators should consider either removing or decreasing the impact of this feature.

The core contribution of this paper concerns modelling competence assessment by describing two complementary assessment methods. By using method 1, evaluators can score and rank learner models according to their domain and modelling accuracy. Applied as a summative method, it informs learners about their overall modelling competence and teachers about their learners modelling level. As a formative method, it helps learners identify their omissions and suggests ways to overcome them. Method 2 is qualitative and provides feedback concerning which parts of the model need improvement, and how they can be realized. It acts as a formative approach, informing educators and modellers about the model constituents. Additionally, the level indication established through this method informs educators and learners on the scientific status of their modelling capabilities.

References

Bredeweg, B., & Forbus, K. D. (2003). Qualitative modeling in education. *AI magazine*, 24(4), 35-46.

Bredeweg, B., Liem, J., Beek, W., Linnebank, F., Gracia, J., Lozano, E., Winer, M., Bhling, R., Salles, P., Noble, R., Zitek, A., Borisova, P., & Mioduser, D. (2013). Dynalearn an intelligent learning environment for learning conceptual knowledge. *AI Magazine*, 34(4), 46-65.

Bunge, M. (1983). *Treatise on basic philosophy: Volume 5: Epistemology & methodology i: Exploring the world*. Dordrecht: Reidel.

Crawford, B., & Cullin, M. (2004). Supporting prospective teachers' conceptions of modelling in science. *International Journal of Science Education* 26(11), 1379-1401.

De Jong, O., Van Driel, J. H., & Verloop, N. (2005). Preservice teachers' pedagogical content knowledge of using particle models in teaching chemistry. *Journal of Research in Science Teaching*, 42(8), 947-964.

LeCompte, M. D., & Preissle, J. (1993). *Ethnography and qualitative design in educational research* (2nd ed.). CA: Academic Press.

Liem, J. (2013). *Supporting conceptual modelling of dynamic systems: A knowledge engineering perspective on qualitative reasoning*. Ph.D. Thesis. University of Amsterdam, Amsterdam, The Netherlands.

Louca, L. T., Zacharia, Z. C., Michael, M., & Constantinou, C. P. (2011). Objects, entities, behaviors, and interactions: A typology of student-constructed computer-based models of physical phenomena. *Journal of Educational Computing Research*, 44(2), 173-201.

NRC. (2012). *A framework for k-12 science education: Practices, crosscutting concepts, and core ideas*. Committee on a conceptual framework for new k-12 science education standards. Board on science education, division of behavioral and social sciences and education. Washington, DC: The National Academies Press.

Schwarz, C., Reiser, B. J., Davis, E. A., Kenyon, L., Achér, A., Fortus, D., Shwartz, Y., Hug, B., & Krajcik, J. (2009). Developing a learning progression for scientific modeling: Making scientific modeling accessible and meaningful for learners. *Journal of Research in Science Teaching*, 46(6), 632-654.

Affiliation and address information

Christiana Th. Nicolaou
Learning in Science Group
Department of Educational Sciences
University of Cyprus
P. O. Box 20537
CY 1678
Nicosia
Cyprus
e-mail: chr.nic@ucy.ac.cy

Rolling Motion: Experiments and Simulations Focusing on Sliding Friction Forces

Pasquale Onorato, Massimiliano Malgieri, Anna De Ambrosis

Dipartimento di Fisica Università di Pavia via Bassi, 6 27100 Pavia, Italy

Abstract

The paper presents an activity sequence aimed at elucidating the role of sliding friction forces in determining/shaping the rolling motion. The sequence is based on experiments and computer simulations and it is devoted both to high school and undergraduate students. Measurements are carried out by using the open source Tracker Video Analysis software, while interactive simulations are realized by means of Algodoo, a freeware 2D-simulation software.

Data collected from questionnaires before and after the activities, and from final reports, show the effectiveness of combining simulations and Video Based Analysis experiments in improving students' understanding of rolling motion.

Keywords

Rolling motion, friction force, collisions, video analysis, simulations, and billiard.

1. Introduction

As it is well known, rolling motion is a complex phenomenon whose full comprehension involves the combination of several fundamental physics topics, such as rigid body dynamics, friction forces, and conservation of energy. For example, to deal with collisions between two rolling spheres in an appropriate way requires that the role of friction in converting linear to rotational motion and vice-versa be taken into account (Domenech & Casasús, 1991; Mathavan et al. 2009; Wallace & Schroeder, 1988).

In this paper we present a sequence of activities aimed at spotlighting the role of friction in rolling motion in different situations. The sequence design results from a careful analysis of textbooks and of research findings on students' difficulties, as reported in the literature. A series of experiments based on video analysis is used to highlight selected key concepts and to motivate students in their exploration of the topic. Interactive simulations, which can be modified on the fly by students, are used to stimulate autonomous investigation in inquiry activities. Measurements are performed through the Tracker Video Analysis open source tool; while interactive simulations are designed and run within the freeware 2D simulation environment Algodoo (<http://www.algodoo.com/>). The sequence of activities is aimed at both high school and undergraduate students and has been proposed for preliminary testing to twenty student teachers (ST). In particular, in the first trial, the following research question was investigated: Is a combination of real experiments and interactive simulations effective in sustaining students' understanding of rolling motion?

2. Students' difficulties

Many papers have investigated students' ideas on the relationship between friction and rolling motion, and identified typical difficulties. In the following we summarize the problematic aspects which we tried to address in the activity sequence.

- (a) The idea of relative motion to understand the kinematic of the rolling body. Students have great difficulty distinguishing between the velocity of a point on a rigid wheel, ball or cylinder as measured with respect the centre of mass, or the ground (Rimoldini & Singh, 2005).
- (b) Sliding friction forces and their relation with the rolling motion on a horizontal plane. Several studies show that the role played by sliding friction forces in shaping the motion of rolling bodies is in some cases underestimated and in others overestimated by students. For example, they do not recognize the action of kinetic friction force in producing the transition from sliding to rotational motion, and, as a consequence, do not realize that kinetic friction force does work. In other cases the role of friction is overestimated. For example, few students recognize that when the condition of rolling without slipping is satisfied a sphere is not slowed by sliding friction forces (Rimoldini &

Singh, 2005). Moreover, from Close et al. (2013) we know that for many students a body cannot rotate or roll in absence of friction because they think that a torque is necessary to maintain rotation.

- (c) The role of friction in rolling on an inclined plane. Students have difficulties in explaining rolling motion along an incline (Rimoldini & Singh, 2005; Close et al. 2013). Some of them are convinced that pure rolling motion along an incline is governed by static friction only. Moreover often they think that a sphere cannot simply slide along a frictionless incline, while for the case in which friction is present, some of them believe that the sphere would remain at rest for small inclination angle, while others expect the sphere to roll without slipping for all angles.

3. Description of the teaching sequence

Didactical choices

We made a few fundamental decisions regarding the design of the teaching sequence which can be summarized as follows:

- Propose activities based on a combination of real experiments and interactive simulations. Measurements are performed through the Tracker Video Analysis open source tool; while interactive simulations are designed and run within the freeware 2D simulation environment Algodoo.
- Let students perform the experimental and modelling activities in small groups. Students are guided through sequenced activities to make observations that they can use as the basis for their models.
- Engage students in the step-by-step process of constructing a qualitative model that they can use to predict and explain the behaviour of rolling bodies. When some degree of formalization becomes necessary, only basic mathematics is used, always in tight connection with qualitative reasoning.
- Encourage autonomous exploration of a complex problem starting from an initial motivating question (specifically, in this case, the question concerns collision between two rolling spheres). Students analyze the problem de-structuring it into sub-problems that they try to solve, by designing Algodoo simulations. Such approach requires students to plan a solution through a sequence of steps while keeping in mind the global issue, and leads them to a thorough exploration of the relationship between friction and rolling motion. Moreover, observing students work and discuss in groups during this activity provides us insight on the role that modelling activity has in scaffolding students' knowledge.

The activities

Main steps of the activity sequence are:

- (i) Measuring and analyzing, through Tracker Video Analysis, the motion of a rolling spool, made by two CDs connected by a wooden cylinder.

To help students realize that the trajectories, and the velocity vectors of a point on the spool measured in the centre of mass and lab reference frames are different, we propose them to record the motion of the spool through a digital video camera, and then to analyse the video with Tracker. The velocity of a point on the edge of the disk is tracked in both the reference frames (Figure 1). Students are invited to compare their predictions with experimental results. The typical cycloidal trajectory in the lab frame is observed and compared with data obtained from Algodoo simulation of the same system.

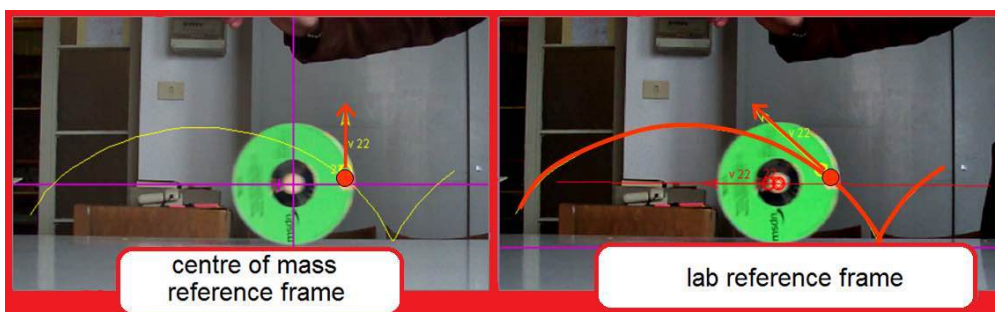

Figure 1. In the snapshot the velocity vectors in the centre of mass and lab reference frames of a point on the edge of the disk are shown at the same instant.

- (ii) Using interactive simulations, the role of friction in the dynamics of the rolling disk is studied, when no other accelerating force or momentum are applied (Figure 2). Students analyze the motion of a disk which is initially sliding on a rigid horizontal frictionless surface and only has a translational velocity. Then the disk

encounters a second rough surface (grey plane). Working with the simulation, the students realize that kinetic friction force on the rough plane produces a decrease in the linear velocity of the disk and an increase in its angular velocity, until finally slipping stops, and pure rolling begins. Therefore simulations help students recognize the null role of kinetic friction in rolling without sliding, and show that, in absence of external forces, no sliding friction (either static or dynamic) acts on a disk that is already in pure rolling condition. We focus students' attention on the fact that, in the first time instants after the disk enters the rough plane, the linear and angular velocities are not yet related by the relation $v = \omega R$, since the disk rolls and slips at the same time. In Figure 2, v and ωR are plotted as functions of time. Students can also verify that if a third, frictionless plane is inserted in succession (the black one on the right in Figure 2), the disk continues to roll without slipping although no friction force acts on it and no change in the trajectories and velocities can be observed.

While working with the simulation, students usually raise two questions: (a) how can the sliding friction force disappear? (b) if the sliding friction force disappears, what causes the torque providing the rotation? The first question reveals a limited understanding of friction as a force that adjusts in magnitude to exactly balance the applied force; the second one shows that students hold a naïve idea of the relation between rotation and torque, similar to the ingenious idea of force as necessary for movement (diSessa 1993).

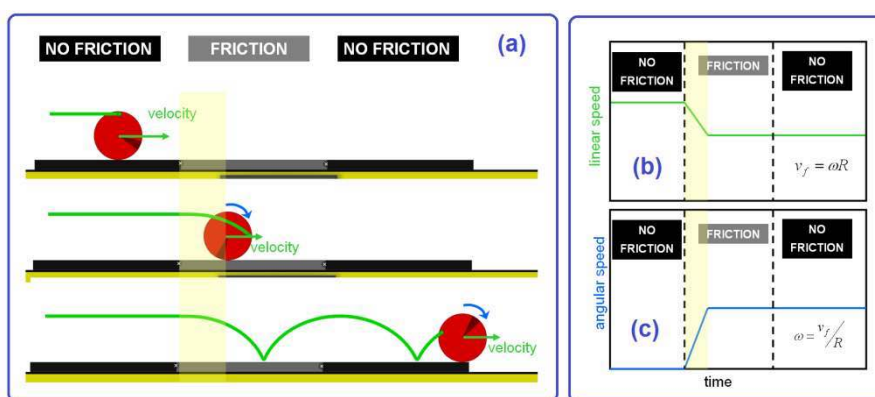

Figure 2. (a) Trajectory of a point on the edge of a disk when it passes from a pure translational motion to a pure rolling motion on a rough plane and then moves in a pure rolling motion on a third frictionless plane. (b) Graphs of the linear and angular speeds as functions of time before, during and after the transition to pure rolling motion. Two phases of the motion on the rough plane are clearly shown, the first one in which friction is operating and doing work, and the second one in which the rolling condition has been reached, and friction force vanishes.

It is useful to point out with students that a friction force appears (a) when two surfaces in contact are in relative motion with respect to one another, or (b) when a force attempts to produce relative motion between two surfaces in contact. Neither of the two conditions occurs when the disk is rolling without slipping and no friction force acts on it. It is of course helpful here to remind students that, when a body rolls without slipping, the point of contact with the surface is always instantaneously at rest with respect to the surface itself.

(iii) Rolling motion with an additional force applied (Figure 3). Using both videos (captured by students and analyzed with Tracker) and simulations, students investigate the motion of a disk rolling down a plane at different inclination angles and focus on the differences between pure rolling and rolling with slipping. They identify the pure rolling condition using the trajectories of a point on the disk edge, but also by verifying if the values of the linear velocity v and of the angular velocity ω of the geometrical centre satisfy the condition $v = \omega R$; in these conditions, students compute the total mechanical energy of the disk and verify its conservation, thus confirming that static friction does no work.

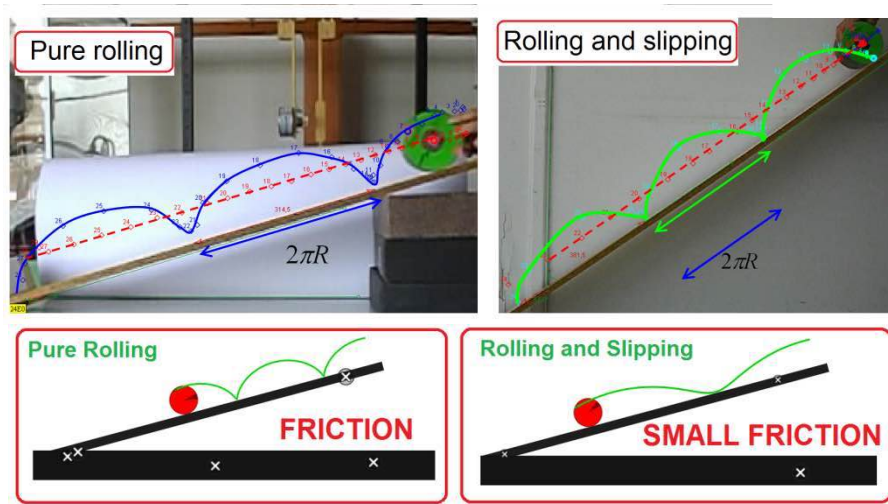

Figure 3. Students capture on video the motion of a disk along an inclined plane. They vary the inclination angle to investigate the differences between the cases of pure rolling, and rolling with slipping. The different measured trajectories of a point on the edge for pure rolling (small tilting angle, distance covered equal to $2\pi R$) and for rolling with slipping (large tilting angle, distance covered greater than $2\pi R$) are reported. Experimental results are compared with simulations, in which students can modify both the slope and the friction coefficient.

(iv) Inquiry activity: collisions between two balls. To engage students in an inquiry activity, we propose them to study the collision between two rolling balls. An ingenious approach to the problem of colliding spheres assumes that no rolling occurs and disregards the effects of friction forces immediately after the collision. However, the description of “real” collisions requires that both rotational and translational motion be taken into account together with the role of friction in converting one into the other (Close et al. 2013; Hierrezuelo & Carnero, 1995).

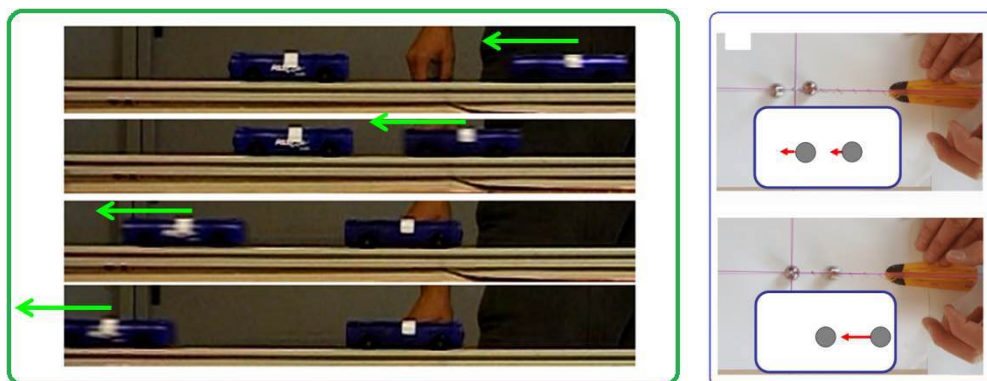

Figure 4. Left: Elastic collision between two identical carts, one of which is initially at rest. Right: Video of the collision between two identical steel spheres, one of which is initially at rest.

We start from an experimental activity in which we ask students to observe and compare the elastic collision between two identical carts on a guide, with the one between two identical rolling spheres (Figure 4). Students first examine the elastic collision between the carts, one of which is initially at rest. A quantitative analysis of the collision is carried out by recording the carts’ motion and analysing the videos.

Using Tracker, students can verify that the results of the experiment are in agreement with the laws of conservation of momentum and energy. Next we propose to students a video of the collision between two identical steel spheres, one of which is initially at rest. We stop the video one instant before the collision, asking students to make predictions about the following evolution. Contradicting students’ predictions, the projectile ball does not stop after the collision. In order to explain this unexpected result students are invited to explore several variants of the experiment by designing and manipulating Algodoo simulations.

Working in groups with the modelling software, students decompose the initial complex problem into sub-problems to analyze the role of different factors and then construct correlations between them. The main steps of this exploration are summarized in the Table 1, where we report the different cases which students modelled during the activity. The strategy followed by each group was different, but the steps reported in Table 1 were common to all groups.

Table 1 Collisions simulated by students during the activity

Projectile motion	μ_P	μ_T	v_P before	ω_P before	v_P after	ω_P after	v_T after	ω_T after
(i) Translating without friction	= 0	= 0	$\neq 0$	= 0	= 0	= 0	v_P before	= 0
(ii) Translating and rotating with friction between projectile and plane	$\neq 0$	= 0	$\neq 0$	$\neq 0$	$\neq 0$	$\neq 0$	v_P before	= 0
(iii) Translating without friction. There is friction between target and plane	= 0	$\neq 0$	$\neq 0$	= 0	= 0	= 0	$v_T < v_P$	$\neq 0$
(iv) Translating and rotating with friction between projectile and plane and between target and plane	$\neq 0$	$\neq 0$	$\neq 0$	$\neq 0$	$\neq 0$	$\neq 0$	$v_T < v_P$	$\neq 0$

The first simulation (the spheres lie on a frictionless plane, and the projectile ball slides without rolling) reproduces the same condition as the cart collision; in fact in this case the projectile ball stops after the collision. In the second simulation the projectile ball approaches with a rolling motion. This helps students recognize that in the case of head-on collision the target ball only acquires the translational momentum of the projectile ball, while angular momentum is not transferred. (In the following activities they can also verify, by changing the friction coefficient between the two spheres, that angular momentum can only be transferred if the spheres exert a friction force one onto the other during the collision). In the third case the target ball is placed on a plane with friction. After the collision this ball departs sliding on the plane, but along the motion kinetic friction produces a decrease in linear velocity and an increase in rotational velocity, until the pure rolling condition is reached. The fourth case models the real situation initially observed, which now students are able to reconstruct and explain, based on previous analysis.

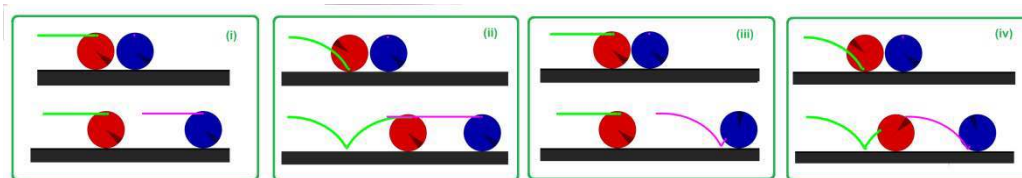

Figure 5 Some examples of Algodoos simulations created by students.

In a further autonomous investigation some students simulate particular billiard shots. For example, they studied how the motion of the cue ball and the result of the collision vary by hitting the cue ball over or below its centre.

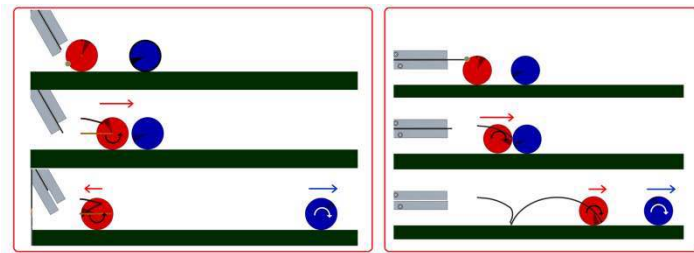

Figure 6 Shots with top or bottom spin and consequences on the motion after the collision.

Other simulations developed by students concern the analysis of the billiard ball dynamics in cushion-ball impacts. In these cases the direction of the momentum after the impact depends on the spin of the ball and the simulation allows emphasizing the role of the friction force due to the cushion in determining such direction.

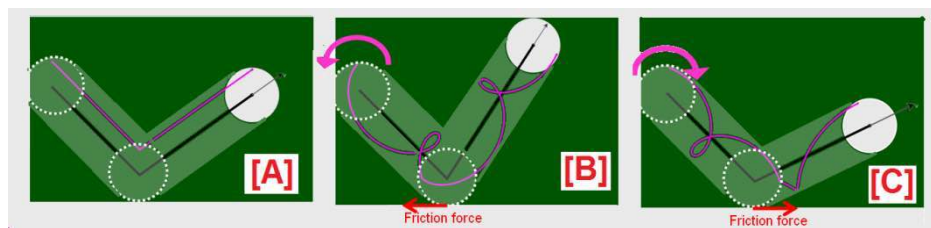

Figure 7 Left or right-hand spin applied to the cue-ball to increase or reduce the angle of reflection and its velocity after impact with a cushion

4. Results

The sequence was tested with a group of 20 graduate students (ST) attending a course for qualification as mathematics and physics teachers. Students performed the experimental and simulation activities in groups of three and completed the sequence in three sessions of 2 hours each. Assistants worked as facilitators, giving support where necessary. Our sources of data on students' progress and ideas included two questionnaires, worksheets filled in during the experimental activities, discussions during and after the experiments, answers to written questions, and a final report in which they elaborated on what elements of the proposed sequence they considered essential. In the following we refer in particular to data collected from the students' final report, and from the two questionnaires, one given before the activities (pre-test) and the other after the end of the sequence (post-test). Some questions were drawn from the literature, to make it possible a comparison of our students' results with those obtained in a different context.

Qualitative results

In their reports ST mainly focus on the autonomous investigation with Algodoo simulations about the collisions between rolling spheres. Students understood well that rolling motion results from the composition of translational and rotational motion, and that in elastic collisions between two balls only the linear motion of the projectile is transferred to the target, while the angular momentum is not transferred:

One of them writes *"The momentum of the ball projectile is entirely transferred to the target ball, but rotational momentum is not transmitted."*

Students are aware of the role of friction (kinetic friction) in the transition from sliding to rotational motion:

"the behavior of the target ball (after the collision) is no doubt due to friction between it and the table; sliding friction force is opposed to velocity, slowing the translational motion and, since it is not applied on the center, also causes an angular acceleration to the sphere."

Students acknowledge that friction can play a motive role:

"the ball does not have a linear velocity immediately after the impact, but is still rotating; then, under the effect of friction force, angular velocity decreases while linear velocity increases"

Students were effectively engaged in decomposing the complex problem of the collision between rolling balls

"When a steel ball collides with a second ball in a central bump, how do they behave? This is a seemingly simple question, but the answer is not obvious and especially dense of physical knowledge. To answer

correctly you should ask: is the surface on which the cue ball is located frictionless? Is the plane where the target ball is located before the collision frictionless?

Students highlighted the role played by software in their learning process

“The software plays a significant role in this activity, because it allows us to freely and easily check the parameters in the game, in order to test our predictions.”

Quantitative Results

The questionnaires were not meant to be comprehensive and cover all topics involved with rolling and rotational motion, but to focus on basic concepts underlying our teaching sequence: rolling and relative motion, rolling on the horizontal plane and role of friction, rolling on an incline and work done by the sliding friction force in the presence of rolling and slipping motion.

In the following, we summarize the most relevant conclusions we drew from the pre-test to present a global picture of students' ideas before the activity sequence.

- Students had great difficulty in distinguishing between the speeds of different points on a rigid wheel with respect to the centre of the wheel or ground. Only 42% of the ST identify the exact direction of the speed of a point on the edge of the wheel in rolling motion. The analogous result in Rimoldini & Singh (2005) was 32%.
- Only a small fraction of ST recognized that a marble rolling without slipping across a rigid horizontal floor is not slowed by friction (32% versus 25% of Rimoldini & Singh (2005)).
- More than 40% of the ST were not convinced that a sphere on a frictionless inclined plane slides without rolling (42% of ST vs. 44% in Rimoldini & Singh (2005)) while, in the case with friction, 32% believed that the sphere remains at rest for a small inclination angle, and 26% that the sphere rolls without slipping for all angles.
- Only 42% of ST were convinced that pure rolling motion along an incline is governed by static friction. Moreover only a small fraction (21%) recognized that the value of the friction force has to be less or equal to the product between the static friction coefficient and the normal force.
- More than 40% of ST did not recognize that the kinetic friction force does work on a sphere which is initially sliding on a rough horizontal plane, and makes the transition to pure rolling motion.

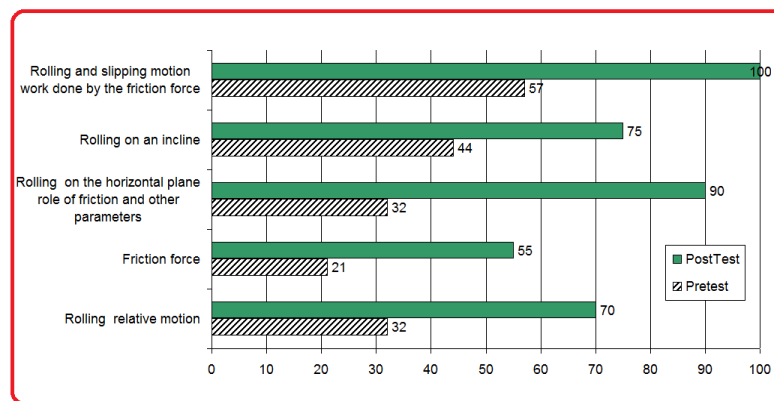

Figure 8 Comparison between pre and post test results analyzing the questions of multi-choice test by concepts. Students answers to question 3 of the pre and post test.

On the whole, in the post-test the percentage of incorrect answers was, for our students, below 25%. This result alone is an indication that the sequence created a fruitful environment for the students' learning, enabling them to address their initial difficulties. In Figure 7 we compare pre- and post-test results for items related to the same concepts. More in detail:

- Answers to the post-test confirmed an improvement of students' understanding of the kinematic of rolling motion and in their capability to distinguish between the speeds of different points with respect to the centre of the wheel or the ground. 70% of the ST correctly answered a question about the velocity of three different points on a rolling wheel with respect to the road, compared to 57% in Rimoldini & Singh (2005).
- After the sequence a large percentage of ST (89%) was able to recognize that a marble rolling without slipping across a rigid horizontal floor is not slowed down by friction. Most students (79%) also understood that no friction force is acting when a body rolls without slipping along an horizontal plane.

- (c) 70% of ST recognized that whether a sphere moving down along an incline undergoes pure rolling, or rolling with slipping, depends both on the static friction coefficient and on the inclination angle.
- (d) 58% of ST answered correctly that the magnitude of the friction force is not necessarily equal to, but lesser or equal than, the product between the static friction coefficient and the normal force.
- (e) 75% of ST recognized the role played by kinetic friction force on a sliding sphere in making it reach the pure rolling condition on a rough horizontal plane.

5. Conclusions

Video analysis based activities were used to highlight experimental situations in which the relationship between friction and rolling is especially complex, or leads to counterintuitive results. Interactive simulations were essential for exploring multiple variations of a given physical situation, and provided the ideal environment for a guided inquiry activity.

Analysis of qualitative data on students' reasoning suggests that this approach allowed students to obtain a richer and more precise understanding of the subject. Comparison of pre and post test results shows that students obtained sensible performance improvements, and overcame many common difficulties. This seems to confirm that a sequence design based on a combination of real experiments and interactive simulations is effective in sustaining students' understanding of rolling motion.

References

- Close, H.G., Gomez, L.S. and Heron, P.R.L. (2013). Student understanding of the application of Newton's second law to rotating rigid bodies *Am. J. Phys.* **81**, 458-470.
- diSessa, A. A. (1993). Toward an epistemology of physics. *Cognition and Instruction*, **10**, 105-225.
- Domenech, A., and Casasús, E. (1991). Frontal impact of rolling spheres. *Phys. Educ.* **26**, 186-189.
- Hierrezuelo, J. and Carnero, C. (1995). Sliding and rolling: the physics of a rolling ball *Phys. Educ.* **30**, 177-182.
- Mathavan, S., Jackson, M.R. and Parkin, R.M. (2009). Application of high-speed imaging to determine the dynamics of billiards *Am. J. Phys.* **77**, 788-794.
- Phommarach, S., Wattanakasiwich, P. and Johnston, I. (2012). Video analysis of rolling cylinders *Phys. Educ.* **47** 189-196.
- Rimoldini, L. G. and Singh, C. (2005). Student understanding of rotational and rolling motion concepts *Phys. Rev. ST Phys. Educ. Res.* **1**, 1-9.
- Wallace, R. E. and Schroeder, M. C. (1988). Analysis of billiard ball collisions in two dimensions. *Am. J. Phys.* **56**, 815-819.

Affiliation and address information

Pasquale Onorato, Massimiliano Malgieri, Anna De Ambrosio
 University of Pavia Physics Education Research Group
 Department of Physics, University of Pavia
 Via Agostino Bassi, 6
 27100 Pavia, PV
 Italy
pasquale.onorato@unipv.it,
massimiliano.malgieri01@ateneopv.it,
anna@deambrosio.vigna@unipv.it

Teaching Optics with a Virtual Mach-Zehnder interferometer: An Analysis of a Collaborative Learning Activity

Alexsandro Pereira de Pereira, Fernanda Ostermann

Departamento de Física, Instituto de Física, UFRGS, Brazil

Abstract

The teaching of optical interference in undergraduate physics courses traditionally involves a detailed discussion on the Young's experiment and other optical devices such as thin films and the Michelson's interferometer. Another interesting, but not usual way of introducing the interference of light is by means of the Mach-Zehnder interferometer. In what follows, we present a microgenetic analysis of part of a collaborative learning activity involving pre-service physics teachers, focused on the use of a virtual Mach-Zehnder interferometer. This activity was part of a wider investigation regarding the teaching of quantum mechanics. The theoretical framework used in this research derives from Vygotsky's sociocultural approach, as outlined by James V. Wertsch. The data gathered in this study consists of video recordings of students' interaction during the task, from which a sequence of utterances was selected and transcribed for analysis. The outcomes of our analysis suggest that the virtual Mach-Zehnder interferometer could be a powerful cultural tool for the teaching of wave optics.

1. Introduction

The Mach-Zehnder interferometer (MZI) is a simple optical device independently developed by Ludwig Zehnder (1854-1949) and Ludwig Mach (1868-1951) in the early 1890s. In this experimental arrangement, a light beam is split into two components by a beamsplitter and then recombined by a second beamsplitter. The MZI is widely used in nonlinear optics research and technological applications (e.g., Zhang et al., 2014). Some physics educators have explored the potential of such device in the teaching of quantum mechanics (Adams, 1998; Müller & Wieser, 2002; Scarani & Suarez, 1998; Pereira et al., 2009). Unfortunately, the MZI is rarely mentioned in physics textbooks, which makes it quite unfamiliar for most high school physics teachers.

In this study, we focus on the use of the MZI in the teaching of classical optics. The teaching of this topic traditionally involves a detail discussion on the Young's experiment and other optical devices such as thin films and the Michelson's interferometer in order to illustrate the optical interference (see, for instance, Halliday et al., 2005). Considering that classical optics is a mandatory component of physics curriculum at high school and that many young students have difficulties with the theory of double-slit interference (Planinšič & Sliško, 2005), we believe that the MZI could be a good alternative to the teaching of such a topic and, therefore, it should be included in training of pre-service physics teachers.

In what follows, we present a microgenetic analysis of part of a collaborative learning activity focused on the use of a virtual MZI developed by our research group (Ostermann et al., 2006). The activity involved a group of pre-service physics teacher and it was part of a wider study that investigates the learning of quantum physics concepts. The first part of the activity was meant to promote a review of some basic concepts of wave optics such as reflection, refraction, polarization, and interference, in order to establish some links between wave optics and quantum mechanics. As we argued elsewhere (Pereira et al., 2009), an analogy between classical optics and quantum

mechanics can be made by giving a stronger emphasis to the wave aspects of quantum phenomena – instead of considering the photons as light corpuscles.

2. A brief explanation of the MZI

In figure 1, a coherent monochromatic light wave, with intensity I_0 , hits the beam splitter BS_1 , which splits the incident wave into two components (paths A and B), both with intensity $I_0/2$. After being reflected by mirrors M_1 and M_2 , each of these components is directed toward a second beamsplitter BS_2 , where they are split into two subcomponents before hitting the detectors D_1 and D_2 .

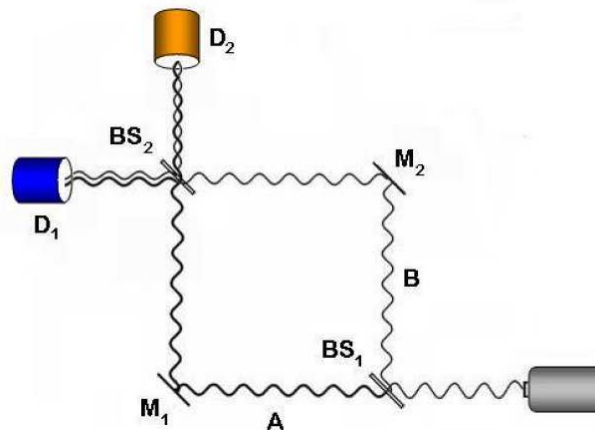

Figure 1. A sketch of the Mach-Zehnder interferometer.

Following the light waves that travel toward D_1 , it is possible to note that both components (paths A and B) are reflected twice – one component is reflected by BS_1 and then by M_2 (path B) and the other component is reflected by M_1 and then by BS_2 (path A). Following the light waves that travel toward D_2 , one can see that one component is reflected three times (by BS_1 , M_2 , and BS_2 through path B) while the other component is reflected only by M_1 (path A).

For simplicity, one may consider that for an angle of 45° with respect to the normal direction every reflection in both the mirrors and the beamsplitters results in a difference in length of $\lambda/4$ (Pessoa, 2005), which correspond to a phase shift of $\pi/2$. As both components hit D_1 with the same phase shift, it results in a maximum of intensity (constructive interference pattern). For D_2 , however, one component has a phase shift of $\pi/2$ and the other component has a phase shift of $3\pi/2$. So, there is a difference in phase of π between these two components, which results in a minimum of intensity (destructive interference pattern).

3. Theoretical Framework

The theoretical framework used in this study derives from Vygotsky's sociocultural approach, as outlined by James V. Wertsch (1991). According to Wertsch, there are three basic themes that run through Vygotsky's writings: a reliance on genetic analysis; the claim that higher mental functioning in the individual derives from social life; and the claim that human action, on both the social and individual planes, is mediated by tools and signs.

Genetic analysis is motivated by the assumption that it is possible to understand many aspects of mental functioning only if one understands their origins and the transitions they have undergone. In this approach, attempts to understand the nature of mental processes by analyzing only the static products of development will often be misled by the appearance of "fossilized" (i.e., automatic) forms of behavior. Although Vygotsky focused most of his empirical research on the development of the individual (i.e., ontogenesis), especially during the childhood, his analysis implies several

other “genetic domains” such as phylogenesis, sociocultural history, and “microgenesis” (Wertsch, 1985).

Related to genetic analysis is Vygotsky’s claim about the social origins of individual mental functioning. In his famous “general generic law of cultural development”, he argued that higher mental functions appear first on “interpsychological” (i.e., social) plane and only later on the “intrapyschological” (i.e., individual) plane (Vygotsky, 1981a). As Wertsch (1991) noted, this law entails several claims that are neither widely shared nor even understood in contemporary psychology. Indeed, the definition of higher mental function involved here is quite different from what psychologists usually have in mind when they use this term. More specifically, it assumes that the notion of mental function, such as reasoning or memory, can properly be applied to social as well as individual forms of activity. This implies an analytic strategy that may appear paradoxical at first glance since it calls on the investigator to begin the analysis of mental functioning in the individual by going outside the individual.

Another central theme in Vygotsky’s sociocultural approach is mediation. His list of semiotic (i.e., sign-based) mediation included “various systems for counting; mnemonic techniques; algebraic symbols systems; works of art; writings; schemes; diagrams; maps; mechanical drawings; all sorts of conventional signs, etc.” (Vygotsky, 1981b, p. 173). One basic property of signs is their transformatory capacities. Instead of simply facilitate an existing mental function (while leaving it qualitatively unchanged), the introduction of signs into a mental function cause a fundamental transformation of that function. Another basic property of signs is that they are social devices. They are social in the sense that: (a) they are typically used in social interaction; and (b) they are neither invented by each individual nor discovered in the individual’s independent interaction with nature, but rather they are provided by a particular sociocultural setting.

4. Design of the study and method

We implemented an instructional activity based on the use of a virtual MZI. This activity involved a group of pre-service physics teachers and it was carried out in a computer laboratory at the university, where the subjects were organized in small groups. A short guide was written to direct students’ actions with the software. This task was part of a wider investigation on the teaching of quantum physics concepts. The activity was divided into two parts: (a) a first moment, involving the interference of light waves, and; (b) a second moment, involving interference of single photons.

In this paper, we focus only on the first part of the task. The general goal of this activity was to promote a review of some basic concepts of classical optics such as reflection, refraction, polarization, and interference. We conducted a genetic analysis by going back to the origins of self-regulative capabilities in the use of optical concepts with the aid of the virtual MZI. According to genetic method, the emergence of such capabilities is to be found in teacher-student interaction, where the teacher provides the “other-regulation” (Wertsch, 1979) necessary for the students to carry out the task. The data gathered in this study consists of video recordings of the activity, from which a sequence of utterances was selected and transcribed for analysis. As an illustration, a microanalysis of three segments of discourse is presented in the next section.

5. Results and discussion

During the activity with the virtual MZI, the students were asked to answer a questionnaire consisted of twelve questions about the behavior of light waves in the MZI. One of these questions regards the optical interference observed in the virtual MZI operating in the “classical mode,” as it is shown in figure 2. In this connection, James and Richard (fictitious names) provide the following discourse.

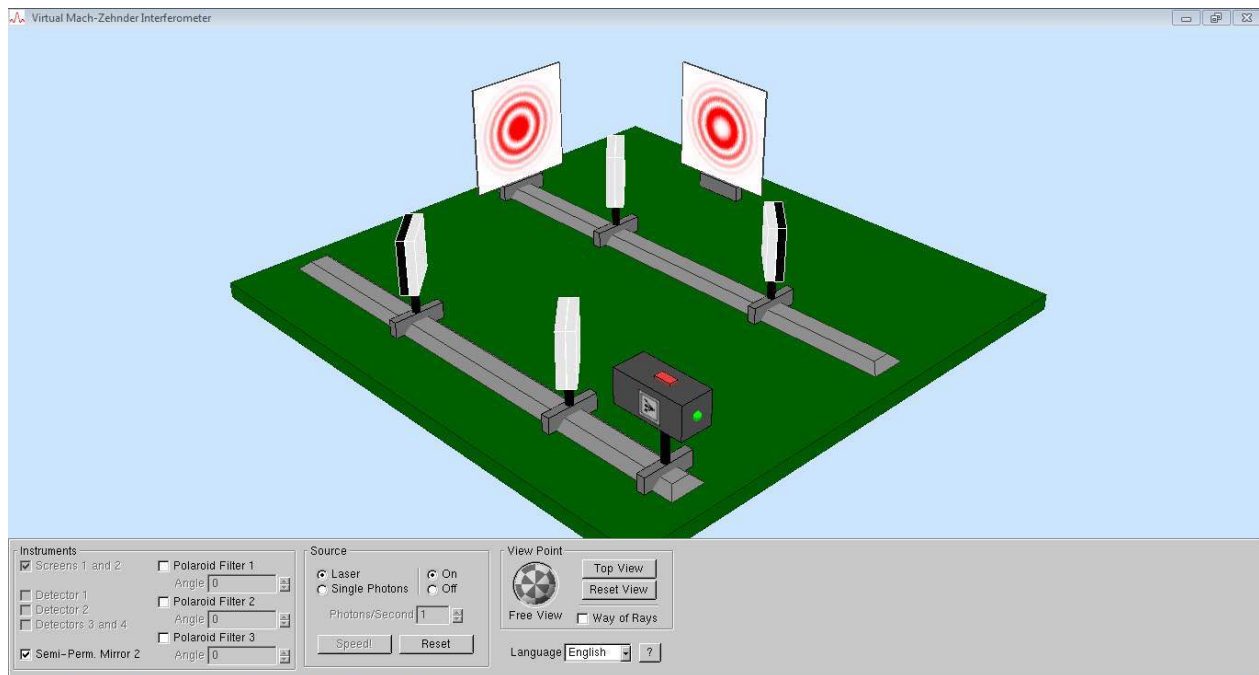

Figure 2. Layout of the virtual MZI: interference pattern on the screens.

Segment 1

- (1) Richard: (Reading aloud) why the beams at the center of the first screen are in phase in relation to each other?
- (2) James: Oh, we have to make this calculation that I learned in the last semester, but I don't remember. Here (pointing to one of the outputs of the first beamsplitter), there is a shift of $\pi/2$. Phase shift of $\pi/2$ in this reflection. There is a calculation that we make that results in a constructive interference here (pointing to the first screen) and a destructive interference here (pointing to the other screen). Here (pointing again to the first screen), they are in phase and here (pointing to the other screen again) they are out of phase. That's why... As they arrive with the same phase here, the center of the screen is enlightened.
- (3) Richard: I don't know anything at all.
- (4) James: I'll call Professor John because I don't remember this.
- (5) Richard: Professor John?
- (6) James: Hey, Professor?

In this first segment of the discourse, James and Richard struggled to answer properly an item of the questionnaire. James proved to understand the definition of the situation by pointing out the need for calculating the phase difference between the light beams that arrive at the center of the screens. As utterance 04 suggests, this is something that James was capable to do, but not without the assistance of Professor John.

Segment 2

- (7) Professor: Hi!
- (8) James: We don't remember how to make this calculation.
- (9) Professor: What is happening here? (Pointing to the first beamsplitter) When an incident beam is 45 degrees with respect to the normal direction, we may have a phase shift of $\pi/2$. Ok? So, there is a phase shift of $\pi/2$ here plus a phase shift of $\pi/2$ here (pointing to the mirror on the right) and here (pointing to the second beamsplitter) there is a transmission – no phase shift. So, it gets here with, let's say, a phase shift of π .
- (10) James: Ok.

- (11) Professor: Now, follow this path. This one will be transmitted; no phase shift.
 (12) James: Ok.
 (13) Professor: Here (pointing to the mirror on the left), we have $\pi/2$. It is reflected again (pointing to the second beamsplitter), plus $\pi/2$. What's the phase difference between them? Zero! They are in phase, so it's a constructive interference.

In the segment above, Professor John started a teacher-student interaction. In this interaction, there is a pattern in which Professor John provides an explanation (utterances 9, 11, and 13), while James only gives a feedback of his understanding (utterances 10 and 12). In this pattern, the only kind of question involved is the rhetorical question – “What is happening here?” (Utterance 9) and “What's the phase difference between them?” (Utterance 13) They were used by Professor John as a semiotic resource to provide the linguistic context necessary for his explanation make sense. Of course, this explanation was also mediated by objects simulated by the virtual MZI such as mirrors, beamsplitters, and screens.

Segment 3

- (14) Professor: Now, let's think.
 (15) James: Now, we can do the same with the other path.
 (16) Professor: Let's take a look at the other path; only the center of the screens. What about this one? (Pointing to the first beamsplitter)
 (17) James: It's reflected.
 (18) Professor: Reflected!
 (19) James: $\pi/2$.
 (20) Professor: It's reflected (pointing to the mirror on the right), $\pi/2$ plus $\pi/2$?
 (21) James: It's π .
 (22) Professor: π ! One more reflection?
 (23) James: Another $\pi/2$.
 (24) Professor: $3\pi/2$. Perfect! Now, let's take a look at this one. Zero (pointing to the first beamsplitter), $\pi/2$ (pointing to the mirror on the left)...
 (25) James: It is only $\pi/2$.
 (26) Professor: What is the phase difference? $3\pi/2$ minus $\pi/2$?
 (27) James: It's π .
 (28) Professor: π !
 (29) James: There is a difference in phase of π .
 (30) Professor: A difference of π is what? Destructive interference.
 (31) James: Destructive interference.

In the third segment, there is a fundamental change in the dynamics of interaction. In utterance 15, James suggested that the same line of reasoning could be applied to the other path in the virtual MZI. In response to James's initiative, Professor John employed a sequence of leading questions, giving rise to an Initiation-Response-Feedback (I-R-F) pattern of interaction, as one can see in the following examples:

Example 1

- (16) Professor: What about this one? (Pointing to the first beamsplitter)
 (17) James: It's reflected.
 (18) Professor: Reflected!

Example 2

- (20) Professor: $\pi/2$ plus $\pi/2$?
 (21) James: It's π .

(22) Professor: π !

Example 3

(22) Professor: One more reflection?

(23) James: Another $\pi/2$.

(24) Professor: $3\pi/2$. Perfect!

Example 4

(26) Professor: $3\pi/2$ minus $\pi/2$?

(27) James: It's π .

(28) Professor: π !

This I-R-F pattern of interaction is a clear case of a higher mental function being carried out on the social plane. This kind of collaborative reasoning occurs when groups of people work together in problem-solving situations. This microgenetic analysis shows that it was only when James tried to take over the explanatory responsibilities formerly carried out by Professor John (utterance 15) that he came to function in a communicative setting involving other-regulation. This other-regulation is precisely what leads to the emergency of self-regulation capabilities on the psychological plane. Needless to say, this process of other-regulation was essentially mediated by objects in the virtual MZI such as mirrors, beamsplitters, and screens.

6. Conclusions

In this paper, we presented as a case study a microgenetic analysis of part of a collaborative learning activity involving a group of pre-service physics teachers, focused on the use of a virtual MZI in the teaching of wave optics. The theoretical framework used in this study derives from Vygotsky's sociocultural approach and our data consists of video recordings of students' verbal interaction, from which a sequence of utterances was selected and transcribed for analysis. A microgenetic analysis of three fragments of discourse showed that the virtual MZI served as a powerful cultural tool for mediating the other-regulation provided by the teacher during the task. This process of other-regulation, carried out on the social plane, is essential for the emergency of self-regulation capabilities on the intrapsychological plane.

References

- Adams, S. (1998). Quantum bombing reality. *Physics Education*, 33(6), p. 387-385.
- Halliday, D., Resnick, R., & Walker, J. (2005). *Fundamentals of physics* (7th ed.). New York: John Wiley & Sons.
- Müller, R., & Wiesner, H. (2002). Teaching quantum mechanics on an introductory level. *American Journal of Physics*, 70(3), 200-209.
- Ostermann, F., Prado, S. D., & Ricci, T. S. F. (2006). Desenvolvimento de um software para o ensino de fundamentos de física quântica [Development of a software for the teaching of fundamentals of quantum physics]. *Física na Escola*, 7(1), 22-55.
- Pereira, A. P., Ostermann, F., & Cavalcanti, C. J. H. (2009). On the use of a Virtual Mach-Zehnder Interferometer in the teaching of quantum mechanics. *Physics Education* 37(3), 197-203.
- Pessoa, O. Jr., (2003). Conceitos de física quântica. [Concepts of quantum physics]. São Paulo: Livraria da Física.
- Planinšič, G., & Sliško, J. (2005). Mechanical model aids understanding of light interference. *Physics Education*, 40(2), 128-32
- Scarani, V., & Suarez, A. Introducing quantum mechanics: One-particle interferences. *American Journal of Physics*, 66(8), 718-721.

- Vygotsky, L. S. (1978). *Mind in society: The development of higher mental processes*. (M. Cole, V. John-Steiner, S. Scribner, & E. Souberman, Eds.) Cambridge: Harvard University Press.
- Vygotsky, L. S. (1981a). The genesis of higher mental functions. In J. V. Wertsch (Ed.), *The concept of activity in Soviet psychology* (pp. 144-188). Armonk: Sharpe.
- Vygotsky, L. S. (1981b). The instrumental method in psychology. In J. V. Wertsch (Ed.), *The concept of activity in Soviet psychology* (pp. 134-143). Armonk: Sharpe.
- Wertsch, J. V. (1979). From social interaction to higher psychological processes: A clarification and application of Vygotsky theory. *Human Development*, 22(1), 1-22.
- Wertsch, J. V. (1985). *Vygotsky and the social formation of mind*. Cambridge: Harvard University Press.
- Wertsch, J. V. (1991). *Voices of mind: A sociocultural approach to mediated action*. Cambridge: Harvard University Press.
- Zhang, S., Zhang, W., Geng, P., and Wang, L. (2014). A Mach–Zehnder interferometer constructed using lateral offset and a long period fiber grating for two-dimensional bending vector sensing. *Journal of Optics*, 16, 1-6.

Using Learning Management System to Integrate Physics Courses with Online Activities: a Case Study

Edlira Prenjasi^{1,2}, Shpresa Ahmetaga¹

¹Department of Physics, University "L.Gurakuqi" of Shkodër, Albania

²National Research Council of Italy-Institute for Educational Technologies, Italy

Abstract

The development of Digital Technologies and especially the increase of their implementation in teaching and learning process have provided researchers in the field of education, teachers, and experts, with the opportunity to experiment with different methods of integrating on line activities with traditional courses.

To this end an important tool is Learning Management System (LMS), a software package that enables experts to create, deliver, and manage online courses.

Many Universities around the world have used LMS during the last decade and have run surveys about its usage from teachers and students. The results of these surveys and of other research carried out from research groups interested in online education show on one hand that the access to online course information, as well as the ease of use of LMS generally are well embraced by principal actors; that the several tools that LMS offers for each area of the course structure can enrich the traditional course. On the other hand, the results of the research show that LMS usage is not explored in all its parts, especially regarding its use in physics courses.

From 2009, at the Department of Physics of "L. Gurakuqi" University, Shkodër, Albania, the usage of LMS for some physics courses at Bachelor and Master level is experimented. The LMS used is Moodle (Modular Object Oriented Dynamic Learning Environment) and the online courses are delivered parallel to the existing courses, reproducing the structure of the traditional course, with the objective to integrate traditional one with online activities.

The aim of the work reported in this abstract is to explore the effective usage of LMS, specifically for the course of Laboratory of Physics at Bachelor Level and the course of Micro Computer Based Laboratory at Master level. In addition, the question of the construction of resources, creation of learning objects and digital learning objects, as well as the collaborative production of knowledge, both strongly interconnected with the online teaching learning environment will be discussed. Open ended questionnaires are used and the answers have been collected and analyzed on descriptive way.

Keywords

Learning Management System, collaborative learning, physics education, online learning activities

1. Introduction

The creation of online courses through LMS have inspired a lot of researchers from the field of education, as well as psychologists, sociologists, specialists on information technology or on communication, anthropologists, etc., to study the online environment. Constructivist theories have been reviewed and revised [3]. Technology's greatest pedagogical impact within this theory may be in the area of social construction and interaction. The exchange of personal, social and cultural norms determines the learning environment which in turn creates the rules of performance in an activity system [1]. In a physical classroom, the personal, social and cultural clues are learned from direct social interaction in the form of body language, visual cues and facial expressions [13], while in a virtual classroom the physical contact is removed.

Even though LMS initially is designed for distant education, it is extended to support also blended and face-to-face delivery, and specifically to this latter, the work described in this paper is related. According to Selim H.M. [19], that grouped as "critical success factors" of e-learning within a university environment into four categories: instructor, student, information technology, and university support, particular attention has been paid to each of them. Since it was the first experience of online course through LMS for both instructors and students, as well as for the Institution when the experience have been realized, the Department of Physics of University of Shkodër, in Albania, the online courses has been designed as similar as possible to the traditional one.

In Albania, there are 15 State Universities, 6 of whom have Bachelor Degrees on Physics and Master Degrees on teaching physics at schools, within the Department of Physics, inside the Faculty of Natural Sciences. The last two decades have raised a number of private universities, which train mainly economists, lawyers, international relations. The web sites of these universities have implemented LMS which are used mostly for administrative purposes, such as online registration of students, giving of credits, marks etc. The applications of LMS to develop online courses, in modality blended or entirely online, are fewer. Previews of researches [16] shown that Albanian students and teachers generally have positive attitudes and good self assessment towards the use of ICT in science education, that teachers make use of a variety of learning resources of which ICT is an option. But, at the same time, about half of teachers report problems of time pressure in science education and affirm that they have not time to use such technologies.

2. Description of the experience

Starting point

During the academic year 2009-2010, at the Department of Physics of the University of Shkodër, we decided to start a pilot experience in Albania, concerning the use of LMS for Physics courses. The first course chosen was “Laboratory of Physics”, as a typical case of collaborative learning. The LMS selected was Moodle. It’s free, it’s used successfully by many universities in the world [8], [4], [9], and the social constructivism approach at its base fits very well with the needs of Laboratory courses.

The purpose of the work was “to study and research how to enhance collaborative production of knowledge using Digital Technologies, with consideration of Laboratory of Physics”. Part of the activities included the production of digital learning objects, such as photos, videos, reports, graphics, designs, etc. and the communication between students and professors through LMS. It was quite a new experience for us, but during the development of these activities, we found particularly interesting the production of videos of lab works by our students, especially their motivation and enthusiasm to perform this activity [15].

The activities were concentrated on the topic of “Optics” that is integrated into a second year course; it includes some experiences from geometrical optics, from wave optics and quantum optics. Students had 120 minutes to develop an activity working under the guidance of the professor and with the support of a technician, but it were not enough to introduce some online activities into our Optics Laboratory. Therefore we decided to use 6 extra hours available. So, the LMS platform was activated, where the professor structured the course. She inserted study material in pdf format; gave individual and group assignments; started forum discussions before each lab work to support the conversation with students, etc.

Due to the interesting results, on 2010 we applied a project in the framework of the National Programme for Research and Innovation and obtained the funding from the Albanian Agency for Research Technology and Innovation.

Development of the project

The funding obtained, gave us the possibility to extend the experience during other three academic years. Highlighting the interesting results described at the starting point, we decided and planned to repeat the same experience of video production in the Laboratory of Physics and to carry out the online course with new Bachelor students during the academic year 2010 – 2011. The lab works includes: the study of oscilloscope; the use of oscilloscope to display periodic and aperiodic signals; discharging a capacitor through a RC circuit; study of damped oscillations in a RLC circuit in series; study of forced oscillation in a RLC circuit in parallel; study of physical pendulum and Steiner’s theorem; study of torsion pendulum, study of three-wire pendulum. During next two academic years, 2011-2012, 2012-2013, we decided to extend the use of LMS to two other courses of Master in Teaching Physics and Mathematics. Specifically, “Use of ICT on teaching - learning science” and “Use of MicroComputer Laboratory (MBL) on teaching physics”. So, other two courses were added to the LMS and each of them had a different usage. Respectively, regarding the first, the platform had prevalently the value of the simulation of an online learning environment, in the framework of an exercise; while, concerning the second course, during which the groups of students perform MBL, LMS is used mostly to deliver results of the Laboratory work.

In all courses some characteristics of Moodle are used, e.g., reading viewing tools (text, file, folder, glossary, page, URL), communicating tools (chat, forum), working together tools (chat forum), working individually tools (assignments, lessons, glossary), tools for presenting, tools for being tests (assignments), tools for receiving feedback (automatic grades, chat, forum), as well as its functionalities, like course

materials repository, available anytime, anywhere; course organization, so that students will know exactly the type of activity and the amount of time to devote to the studying of each course module.

3. Research questions and methodology of research

Many universities in the world have run surveys about the usage of LMS and the expectations of the students. The results have shown that a lot of aspects can be improved and that LMS usage is not explored in all its parts [6], [18], [12]. So, during the development of the project, we found important to investigate the student's expectations on LMS, the use of which was quite a new experience at our Department. Open-ended questions were designed as such on purpose to encourage students to give a wide range of responses. The questions are focused on three principal arguments: What are your expectations about LMS? What are your expectations about having lessons online through LMS? What are your expectations about the relations professor-student and student-student using LMS?

The survey is extended to the students involved on the experimentation from the academic year 2009-2010 to 2012-2013. The sample is composed from 33 students involved in the experimentation, 22 of them followed Bachelor studies in Physics and 11 of them, followed Master studies in Teaching Physics and Mathematics. The online courses developed as mentioned in the abstract are: "Laboratory of Physics", "Use of MicroComputer Based Laboratory on teaching physics", "Use of ICT on teaching-learning science". Each student has followed one or two courses through the support of the Learning Management System. The survey is conducted at the end of the online course.

The data collected from interviews have been manually analyzed highlighting the themes that are particularly dominant for each question, as well as concepts that run around these themes. The results are represented in a descriptive way.

4. Considerations

Students expectations about having lessons online through LMS

81,8% of students that follow the Master and 31,8% of Bachelor students, expect improvement of teaching learning process. From having lesson online via LMS, they expect a fundamental change in the manner of teaching the subject. They affirm: "It seems that the professor is always available to answer any questions at any time, questions concerning the subject of study, as well as the organization of the course"; "Online lessons are always available, as well as the opportunity to ask questions and have clarification; coherence with new methods of teaching and learning; improvement of computer skills; sharing experiences".

81,8% of Master students and 41% of Bachelor students, expect a good support for their studies. They write: "You can have the course information and lessons within one click, the online course has a logical flow that support students in their studies"; "I expect that LMS will be used in a great number of Albanian Universities, because it will support students during the carrying out of the course."

A great part of all interviewees like the innovation of teaching learning process, specifically 41% of Bachelor students and 63,6% of Master students. Students affirm: "On this manner I acquire new methods and techniques for innovative learning, as well as computer skills."; "We use digital technologies every day in our personal lives, this allow us to interact with other similar users to a social level, to share experience and information. More important becomes such interaction in the professional life, and this is the innovative aspect of LMS usage; I expect that LMS will be used as a professional social network for the development of a course." 50% of Bachelor students expect to gain time through the use of LMS.

Students expectations about LMS

Some Bachelor students expect through LMS more access to the materials concerning the latest achievements in science, specifically 22,7% of them. They affirm: "The presentation of the latest achievements in science can be accomplished through the multimedia options offered from LMS, thus enriching the teaching learning process."; "LMS can be used as a tool for students to present the latest achievements of science."

42,4% of interviewees affirm that LMS plays an important role in the development of teaching methods, specifically 36,4% of Bachelor students and 54,5% of Master students. 36,4% of Bachelor students affirm that LMS is a great achievement for our era of massive education.

33,3 of interviewees affirm that they expect that the application of the LMS will grow, specifically 27,3% of Bachelor students and 45,5% of Master students. One of them affirms: "Due to the advantages that it presents I hope that LMS will be used in all universities, and why not in the schools as well."

One student said that she expects a radical change in the philosophy and methodology of teaching, that the use of LMS allows an active participation of the students in the learning process and it make teachers feel free from the negative formalism.

Students expectations about the relations professor-student and student-student using LMS

81,8% of Master students and 41% of Bachelor students affirm that LMS plays an important role in the construction of relationships professor-student; They write: "I like this kind of communication student-professor, I find it very direct and I feel free to ask everything."; "LMS enables online communication with the professor and other colleagues, and it makes the communication very collaborative."

While 18,2% of Bachelor students don't believe that the relationship professor-student can be construct via the LMS. Some of them write: "I don't expect big things. I don't think it is a special method to establish professor-student relationships."; "I don't believe that the relationship professor-student can be constructed via the LMS. For me, face to face relationship is very important."

Both Master and Bachelor students expect in the same percentage, 63,6%, that LMS support student-student communication and relationship. Some of them affirm: "Student-student communication is important, especially in the context of a collaborative work, e.g. Laboratory of Physics, when we must write the conclusions of a work, a study or work with different scientific profile."; "Concerning student-student relationship, it represents a good opportunity for everyone to exchange opinions and take appropriate responses in relation to the work to carry out."

Also, both Master and Bachelor students expect in the same percentage, 54,5%, that the communication through LMS improve the effectiveness of the course. "It enhances communication among students and increase the effectiveness of learning."

5. Conclusions

In the described experience the LMS has been used successfully for different physics courses. Generally students were enthusiastic about its use and believed that it should be used more widely. They were positive about using online communication as a means for sharing knowledge and information, for discussing and interacting with professors and with other students. The majority of students commented positively on student to student and student to professor interaction, as well as about the potential of LMS on communication and sharing. They were happy to have the flexibility of accessing lecture notes online. They recognized the potential for using communication and other tools to enhance their learning. Also, they felt that communication and other tools were very important for their learning. But, there was a small part of students that showed reticence towards new ideas of learning with the LMS and have not confidence on the online communication. At this point, we agree with the suggestion of Hirata [5] that new methodologies for diverse users of LMS should be developed.

References

- [1] Benson, A., Lawler, C., & Whitworth, A. (2008). Rules, roles and tools: activity theory and the comparative study of e-learning. *British Journal of Educational Technology*, 39 (3), 456-457.
- [2] Bonk, C. J., & Cunningham, D. J. (1998). Searching for learner-centered, constructivist, and socio-cultural components of collaborative educational learning tools. In C. J. Bonk & K. S. Kim (Ed.). *Electronic collaborators: learner-centered technologies for literacy, apprenticeship, and discourse* (pp. 25-50). New Jersey: Erlbaum.
- [3] Dougiamas, M., Taylor, P. (2003). Moodle: Using Learning Communities to Create an Open Source Course Management System, *Edemedia*.
- [4] Garcia, J. et al. (2013). IT or not to be: The impact of Moodle in the education of developing countries. 2MoodleResearch Conference 2013.
- [5] Hirata, Y. & Hirata, Y. (2012). Learning Management System: Japanese Student Perceptions and Expectations. In K.C. Li et al. (Ed.), *ICT 2012, CCIS 302* (pp. 11-24). © Springer-Verlag Berlin Heidelberg
- [6] Holzl, A. (2003). What Learners Want from a Learning Management System. *Paper presented at the AusWeb 03*, Southern Cross University, Lismore.

- [7] Johnson, D.W., Johnson, R.T., Smith, K.A. (1991). Cooperative learning: Increasing College Faculty Instructional Productivity. *ASHE-ERIC Higher Education Report* (4), George Washington University.
- [8] Klindžić, J., Lazić, N., Perković, M. (2013). The Other Way Around: How We Learned to Stop Worrying and Love the Dedicated LMS Support. *2Moodle Research Conference*.
- [9] Kotzer, Sh., Davidson, Y. E. (2012). Learning and teaching with Moodle-based E-learning environments, combining learning skills and content in the fields of Math and Science & Technology. *1Moodle Research Conference*.
- [10] Koumi, J. (2006). *Designing Video and Multimedia for Open and Flexible Learning*. London: Routledge.
- [11] Lavonen, J. (2008). Learning and the use of ICT in Science Education. In: *Effective use of ICT in Science Education*, University of Edinburgh, UK, ISBN 978-0-9559665-0-7.
- [12] Mering, J., & Robbie, D. (2004). Education and electronic learning - Does online learning assist learners and how can it be continuously improved. *Paper presented at the HERDSA conference*, Miri, Sarawak.
- [13] Murphy, E. & Manzanares, M. (2008). Contradictions between the virtual and physical high school classrooms: A third-generation activity theory perspective. *British Journal of Educational Technology*, 39 (6), 1061-1072.
- [14] Newton, L.R., & Rogers, L. (2001). *Teaching Science with ICT*. London: Continuum.
- [15] Prenjasi E. Ahmetaga Sh., Allegra M. (2010). On Line Learning To Support Laboratory Activities In General Physics, *Proceedings of International Conference of Education, Research and Innovation*", 5338-5342.
- [16] Prenjasi, E., Allegra, M., Demkanin, P. (2011). The use of ICT by pre-service and in-service teachers of science. A case study in Albania. *Proceedings of 5th International Technology, Education and Development Conference*, Iated, 1654-1659
- [17] Prenjasi, E., Ahmetaga, Sh., Allegra, A., (2013). Integrating audiovisual practices in the design of online courses of laboratory of physics. *Proceedings of the 9th International Scientific Conference "eLearning and Software for Education" Bucharest*, Volume II. Editura Universitatii Nationale de Aparare "Carol I"
- [18] Robbie, D. (2005). Students use and experiences of Bb at Swinburne - A longitudinal study 2001 - 2005. *Paper presented at the Blackboard Asia Pacific Users Conference*, Melbourne.
- [19] Selim, H.M. (2007). Critical success factors for e-learning acceptance: ConWrmatory factor models. *Computers & Education* (49), 396-413.

Affiliation and address information

Edlira Prenjasi
Consiglio Nazionale delle Ricerche
Istituto delle Tecnologie Didattiche
Via Ugo la Malfa, 153
90146 Palermo, PA
Italy
e-mail: edliraprenjasi@yahoo.it

Design, Training Exercises, and Feedback in an Online Learning Environment about Electrons in Electric and Magnetic Fields

Stefan Richtberg, Raimund Girwidz
Ludwig-Maximilians-Universität München

Abstract

One outstanding feature of modern digital media is that they can provide an interactive learning environment, which offers context-sensitive feedback on learners' activities. Furthermore, in multimedia applications the mode of feedback is not limited to text and can easily be combined with different types of visualization. Those illustrations can be dynamic, integrated, and linked to further explanations to foster a deeper understanding. It is also possible to combine pictures or a live stream of real experiments with graphical overlays like plots of different functions. This is the first step of using augmented reality to connect experiment and theory in a stronger way. Based on these theoretical considerations, we have developed a [web-environment](#) where students can perform realistic experiments with an electron beam in an electric or magnetic field. A study with students at the age of 16-18 was performed to analyse strengths and weaknesses of design, tasks, and feedback. First results indicate that students have no problem to use the environment and to manage the different tasks. But not all students are able to test and rate hypotheses with the experiment in an appropriate way.

Keywords

virtual experiment, remotely controlled experiments, augmented reality, electrons, fields, design, feedback

1. Introduction and Theory

Many studies were carried out concerning the use of multimedia to enhance scientific inquiry and learning. Fundamental rules for the design of applications regarding multicoding, multimodality, and avoiding cognitive overload were derived (e.g. Mayer, 2009). The necessity of guidance was discussed critically (e.g. Kirschner, Sweller, & Clark, 2006; Hmelo-Silver, Duncan, & Chinn, 2007). Different support components for scaffolding and scaffolding strategies were described (e.g. Zhang, Chen, Sun, & Reid, 2004; Azevedo, 2005; Quintana et al., 2004; Zhang & Quintana, 2012 Paul, Podolefsky, & Perkins, 2013) and their effectiveness was tested (Fund, 2007). Also the influence of feedback in general and different feedback forms in computer-based learning environments were studied (e.g. Mason & Bruning, 2001; Krause, Stark, & Mandl, 2004; Shute, 2008).

When developing a new computer-based application for students or a corresponding website, all these guidelines must be taken into consideration. But first of all, it is important to determine benefits by using the computer in the specific topic and the intended user scenario. In our context these benefits are enabling student activities, providing individual feedback, and strengthening the connection between theory and experiment.

1.1 Using the Computer Against a Lack of Student Activity

When introducing the motion of electrons in fields, it is almost impossible to perform student experiments. For typical experiments expensive and fragile equipment is needed, like an electron deflection tube or a cathode ray tube. Likewise, for these experiments a voltage up to 5 kV is necessary, so the experiments are potentially dangerous. Here, the use of remotely controlled or virtual experiments is a serious alternative.

1.1.1 Remotely Controlled Laboratories (RCLs)

In a remotely controlled laboratory (RCL) it is possible to control a real experiment over the internet. On the user side, only a computer or a smartphone and a stable internet connection are required (see figure 1). On the laboratory side, for this purpose, a special experimental setup is needed because all modifiable values must be controlled by a computer. The whole experimental setup is shown in a live stream, so the user can detect changes easily or perform measurements.

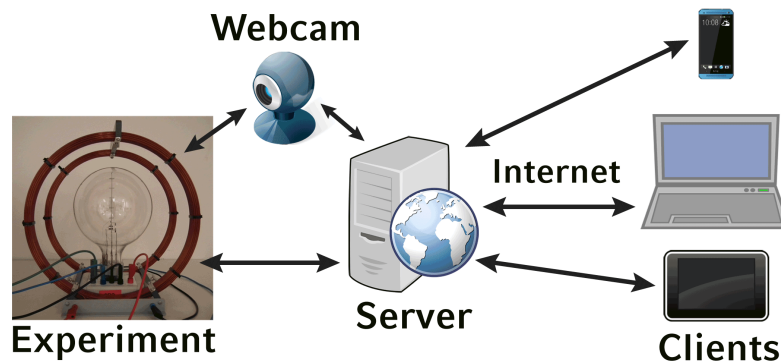

Figure 1. General setup of a remotely controlled laboratory (RCL)

There are some advantages using a RCL. With RCLs students can perform experiments in a greater range of topics. They can run experiments, which aren't available at their school or university, and they can do so at any time and from every place with an internet connection. That is especially helpful for students, which cannot be permanent on campus. Another advantage is that performing a RCL generates real data. Working with real, by themselves generated data can be much more motivating for students than working with given examples. Furthermore, it can be fascinating to control an experiment far away in a distant country. Also institution can share their RCLs, so they can be more cost efficient. In comparison to a normal lab experiment students do not have to set up equipment in a RCL. This has potential experimental drawback but it avoids mistakes in the experimental setup. So the focus is completely set on the experiment itself (Lowe, Newcombe, & Stumpers, 2013). A big disadvantage for using RCLs in classroom is that only one user at a time can control the laboratory. Here a virtual experiment has benefits.

1.1.2. *Virtual Laboratories (VLs)*

A virtual laboratory (VL) is a computer based environment, where students can perform the experiments in a completely digital version. The user does not control a real experiment somewhere, he only works with a digital representation of the experiment and gets the data implemented in the program. The look of the most VLs is related to the real experiment. Often, real pictures or schematic sketches of the parts are used. Normally, the experiment is controlled by sliders or input fields, where students modify a value in a fixed scale. Sometimes, it is also possible to vary the experimental settings directly by moving or clicking on parts of the experiment. The only things which are needed to perform virtual experiments are a computer and an internet connection. Some VLs provide also an offline-version. In addition, it is possible to perform as much experiments as you like at a time, so every student can follow his own assumptions and make his own discoveries. Similar to RCLs with VLs experiments in a greater range of topics can be performed by students themselves. Furthermore, in most VLs the experimental setup is fixed and all attention is on the experiment itself.

1.1.3. *Integrate RCLs and VLs in a Learning Environment*

New technologies allow more features than only controlling experiments by clicking on buttons or manipulating sliders. Using a computer can structure the whole experimental process from generation of hypotheses to evaluation and interpretation of data. Also, adding helpful pictures and explanations, if required even as overlay on the real experiment, is possible. This strengthens the connection between experiment and theory. So RCLs and VLs can be refined to learning environments, where every student processes large sections of the experimental process. Also, outstanding features of learning environments are interactivity and adaptability.

1.2 *Different Features to Support Knowledge Acquisition in a Learning Environment*

This chapter explains some of the special features a digital learning environment can afford in more detail and elucidates the way we implemented the general guidelines for learning with multimedia in our specific environment.

1.2.1. *Scaffolding in a Computer Based Environment*

Students need scaffolding to inquire an experiment and to detect casual relations in a qualitative as well as a quantitative form. Focused on learning in digital environments, different scaffolding components are

described in literature and were found to be effective. According to Fund (2007) there are four major explicit support components.

- Structural components guide the user through all activities, afford orientation, and can indicate the learning goal of a program. In our environment the navigation bars provide this type of scaffolding (see figure 2).
- Reflection components forces processes, like monitoring and self-regulation. We stimulate the meta-cognitive skills by giving individual feedback on users actions (see figure 3).
- Subject-matter components deliver instructions or hints. They should provide support for the knowledge acquisition in critical places of the learning process. Our user interface includes a hint-button with task-specific support.
- Enrichment components build connections between the current and related problems. So a knowledge network can emerge and improve understanding. In our learning environment there is a separate part about the analogy between electron motion in electric fields and the motion of a projectile fired horizontally.

There are also implicit scaffolding elements in interactive simulations and laboratories. So general layout aspects, like the opening screen, the range of interactions, and specific illuminated cases, can support productive working with an experiment (Podolefsky, Moore, & Perkins, 2013).

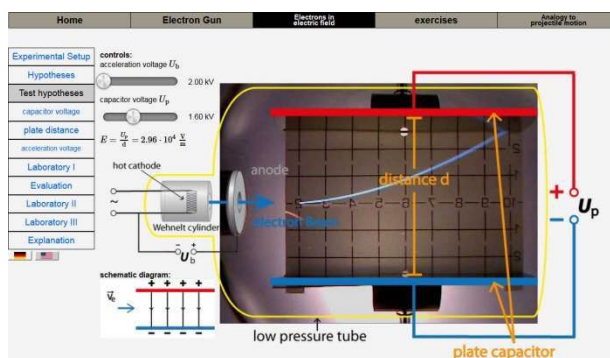

Figure 2. User interface with navigation bars as structural scaffolding and integrated, dynamically linked representations of the experimental setup in an electron deflection tube.

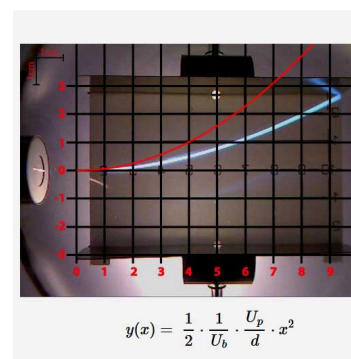

Figure 3. Overlay of graph and picture of the experiment.

1.2.2. Using Multiple and Dynamic Representations

Sometimes, it is easier to explain things with a picture than with words. But pictures can be shown on the overhead projector or in a printed version. The additional value of the computer is that the digital environment allows the combination of different visualisations. These visualisations do not need to be static; also animated pictures or videos are possible. Indeed, using multiple representations increases the cognitive load but it performs different functions in the learning process as well. So multiple representations can support complementary processes and information, they can constrain interpretations, and they can lead to the construction of a deeper understanding (Ainsworth, 1999). To support students using multiple representations, it is helpful to integrate the representations. So, the relations between the different representations are directly visible and it is “easier to interpret the similarities and differences of corresponding features” (van der Meij & de Jong, 2006, p. 201). Furthermore, dynamic linking shows common features in multiple representations. Visualizations are dynamically linked when a change in one representation is shown automatically in the other visualization. So dynamically linked representations support the development of relations. In our environment we use a range of different visualizations such as pictures, graphs, schematic diagrams, and symbolic representations. Several of these are integrated, for example, the real picture of the electron deflection tube and the schematic diagram of the whole experimental setup (see figure 2). In addition, all representations are dynamically linked. So, when learners manipulate the acceleration voltage of the electron gun with the controls, the picture of the experiment changes in a corresponding way. Also, the schematic diagram of the electric field in the lower left corner adapts to the new experimental settings.

Animations are attractive and motivating for students but also cause a heavy cognitive load (Betrancourt, 2009). So animations should be used carefully and when an animation is presented other cognitive load

should be reduced. Otherwise, especially low performing students do not get benefits from complex animations. We utilise an animation just once in the chapter about the motion in electric fields and once in the chapter about electron motion in magnetic fields. The function of these animations is to explain the user interface step by step. Here, the user's attention is directed by the moving or appearing parts. The animation also shows connections between different visualisations.

1.2.3. Augmented Reality

One outstanding feature of our environment is the overlay of a plot of a function and a picture of the real experiment or the live stream of the experiment (see figure 3). The graph of the function augments the real-world environment and makes it digital manipulable. The function, which describes the electron motion, can be developed with fixed formula modules. This is, especially for low achieving students, helpful because it is difficult to deduce a formula out of theoretical deliberations and experimental experiences. High achieving students can also use a free input line for formula development. The input line allows all common calculations including physical constants and variables, like the acceleration or capacitor voltage.

The use of augmented reality in physics education is a new research area with no fixed and save guidelines. First of all, it provides additional information and can be helpful for learning in this way. Continued from the findings about multiple representations augmented reality has high potential to connect experiment, theory and, mathematical description in a new and intuitive way. In our environment, for example, a theory to describe an experiment in a formula can be checked by comparing the plot of the function and the real experiment. Applying augmented reality makes this really easy, so all learners can do this by themselves. They just need to contrast the plot and real electron path in the experiment. The result is visible with unaided eyes. In our opinion, augmented reality can also lead to a deeper understanding of formulas and equations describing physical systems. It supports the building of knowledge networks by linking formulas directly to visible phenomena.

Furthermore, the type of augmented reality used in our environment gives the learner feedback about his learning progress.

1.2.4. Individual Formative Feedback

Individual formative feedback is another feature enabled by using a digital environment. The computer can analyse user-input and user performance and react with preset feedback.

An appropriate definition of formative feedback can be found by Shute. She understands feedback as "information communicated to the learner that is intended to modify his or her thinking or behavior for the purpose of improving learning" (Shute, 2008, p. 154).

Further, feedback-research distinguishes different types of external feedback. Characteristics for a classification can be the feedback source, the style (text, graphic, and acoustic), the timing, or verification and elaboration. Feedback can be presented immediately after an user-action, it can be delayed or it can be shown only on demand by the learner. Below four main types of feedback elaboration, which are often used in digital learning environments, are described (cf. Narciss, 2006).

- Knowledge of performance (KP): This is a summative feedback for several exercises and contains information about students performance in general, not related to a single task.
- Knowledge of result (KR): KR-Feedback rates an answer or an action performed in right or wrong. It contains no further information for error-correction.
- Knowledge of correct result (KCR): This feedback also rates an answer or an action performed in right or wrong. But if the answer given is incorrect, KCR-Feedback presents the correct answer in addition. So, it contains more information than KR-Feedback.
- Elaborated feedback (EF): Elaborated feedback also makes obvious, if an answer is right or wrong. But if it is wrong instead of the correct answer, it provides additional information to guide the learner to the correct answer. This information can contain solution strategies, explanations, or a specification of an error.

Feedback should influence the experimental and the learning process in different ways. So, feedback shows a gap between the actual and the desired performance. This reduces uncertainty, forces meta-cognitions as well as troubleshooting, and is explicit scaffolding. Individual feedback also focuses on learning because it is related to the activities of the learner. So, students do not only play around with the environment. Feedback also affects the task-motivation in a positive way. Students work harder on a task and spend more time on tasks when a feedback is given, because everyone tries to get a positive feedback.

Our environment provides external feedback in textual and graphical form. But we apply different feedback types because every task needs an appropriate feedback. For the multiple choice questions we use KR-Feedback, which appears immediately after the user clicks on an answer. In the task about the experimental setup, where technical terms must be matched with parts of the setup, we are using also KR-Feedback, but here it is an on-demand feedback. So, students can change their answers many times while working on the task. Every time the students are working with equations or a mathematical description of the electron trajectory the plot is an elaborated feedback. The plot is an immediate feedback, because it is visible every time.

2. The Learning Environment About Electrons in Electric and Magnetic Fields

In this chapter the developed learning environment will be briefly presented and our main intentions are described.

2.1 Technical Aspects

Our learning environment is developed as website based on HTML5 and JavaScript. So, it is possible to run the experiments in every web-browser. Simultaneously, it allows the use of our environment with all operating systems like Windows, Mac, Linux, or Android and with different devices such as PC, Tablet-PC, and Smartphone. Another advantage is the possibility to track every user interaction with the environment in a database. So a web-based laboratory can generate valuable data for research without any repercussion.

2.2 Tasks and Training Exercises

The experimental process in our learning environment, using VLs or RCLS, follows the experimental process in typical lab work. At the beginning, the students get a first overview and have to generate hypotheses. After an introduction in the laboratory they have to check and rate their hypotheses by using the VL or RCL. Then step by step the influence of single parameters is observed and the mathematical equations for the electron trajectory can be evolved. In every stage the environment provides hints, explanations, and feedback. Furthermore, the website establishes equations gradually and gives detailed explanations. Using the VL about electrons in magnetic fields it is possible to measure the charge-to-mass ratio of an electron. The environment also contains training exercises to repeat important facts and knowledge. So, it covers the complete topic. For a full overview check the free to use environment on <http://www.didaktik.physik.uni-muenchen.de/elektronenbahnen/en/>.

2.3 Intentions

Our agenda, when developing the environment, was to enable passing large parts of the experimental process for students. Furthermore, we build a strong connection between experiment, theory and mathematical description by using multiple representations and augmented reality. So, students should learn important equations describing the motion of electrons in electric and magnetic fields as well as the influence of single parameters on the experiment. The part, where students generate and check hypotheses, also allows assessing students experimental skills. The environment logs all user-actions and records the individual learning path. So, it is possible to check, if learners rated their hypotheses correctly and how they got to their decision.

3. Methods

In a first exploratory research we focussed on the chapter about the electron motion in the field of a plate capacitor. Here, the learning subjects are generating hypotheses, check hypotheses with the digital experiment, and developing the formula for the electron motion. Main research aims were to check the usability, to find subject matter difficulties, and to detect experimental difficulties. Tasks were such difficulties appear are critical points of the environment and in the learning process. Here, implementing support seems particularly effective. Also, we were interested in the prior knowledge students have about parabolic motions, like a projectile fired horizontal.

The study had a sample of 52 eleventh graders out of three classes of a Bavarian secondary school. The research procedure consisted of a paper-and-pencil pre-test, of 45 minutes work with the environment on a PC and, of a paper-and-pencil post-test. As pre-test we used eight items out of the force concept inventory relevant to parabolic motion and students had 20 minutes to work on these items. The following physics lesson took place in the computer lab and students worked on their own for 45 minutes with the chapter “electrons in electric fields”. The only thing the teacher had to do in this lesson was to give the web address to the students. So, the teacher has no influence on the students’ performance. While working with the website all user input, clicks as well as keyboard input, was logged in a MySQL-database. The post-test with

22 items, subdivided in four domains, took place two to four days after the students worked with the website. Working time was 30 minutes and the whole data analysis was done with SPSS 21.

4. Results

As shown in figure 4 the pre-test scores, concerning prior knowledge about parabolic motions, are inconsistent. From 44 students eight students answered all eight items correct but also eight students solved only two multiple-choice questions. Otherwise, there are six students with three points, eight students with four point, and five with five points. So, the students have very different prior knowledge.

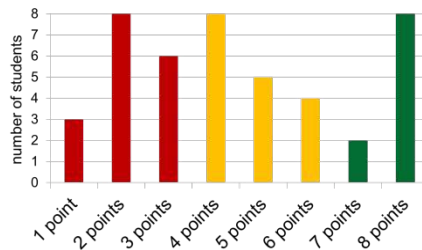

Figure 4. Overview of different feedback types used in our environment.

When working with the website the first exercise was to choose hypotheses about the influence of the acceleration voltage and the influence of the deflection voltage on the trajectory of the electrons in the field of a plate capacitor. Barely half of the students chose the correct hypotheses, regarding the influence of the acceleration voltage (see figure 5). But also 40 % of the students thought, that the acceleration voltage has no influence on the electron path in the plate capacitor. The students' hypotheses about the influence of the deflection voltage matched better with the reality. Two-thirds of the students chose with „the higher the capacitor voltage the bigger the deflection“ the correct hypothesis. Only 20 % thought, that the deflection voltage has no influence on the electrons path.

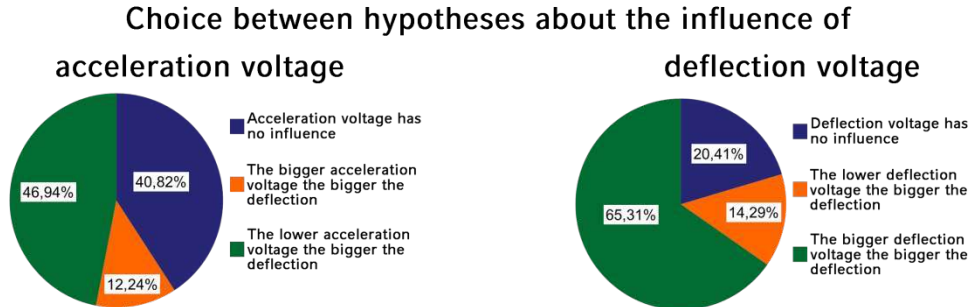

Figure 5. Frequency of by students selected hypotheses about the influence of acceleration and deflection voltage.

But choosing an incorrect hypothesis is not a problem, it is a normal step in the experimental process. Experiments are carried out to test hypotheses. This is the second task for the students in our environment. Here, our data shows a result similar to this at the first task. Only two-thirds rated their own hypothesis about the influence of the acceleration voltage correctly (see figure 6). In the other third we could identify some students who remained with their hypothesis, that the acceleration voltage has no influence. The rating about the influence of the deflection voltage is much better. Here 85 % rated their own hypothesis the right way.

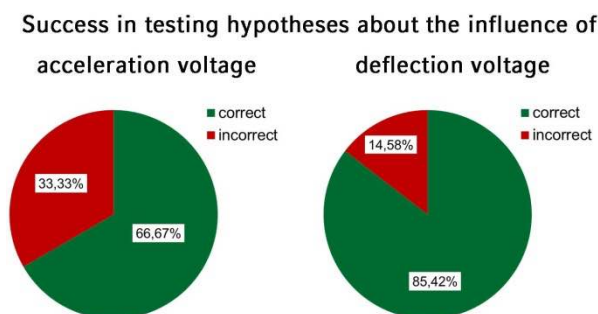

Figure 6. Success in testing hypothesis about the influence of acceleration and deflection voltage with the experiment

5. Discussion

A potential cause of inconsistent scores in the pre-test concerning prior knowledge about parabolic motions is the Bavarian curriculum. The typical parabolic motion of a projectile fired horizontally is only an optional topic. So, probably only some students worked on this topic in 9th grade. As a consequence, the learning environment should be understandable without prior knowledge about parabolic motions. Another choice is to add a short introduction about projectiles fired horizontally in the environment. At the moment, the analogy between electron motion in electric fields and projectile motion in the field of gravity is an enrichment chapter after the experimental part. Here, further research can be helpful to decide which way is more effective.

Our data verify that student interact with the environment and use the sliders to modify the experimental settings. So, from our view the website enables student experiments. The data about the chosen hypotheses show a difference in students' understanding between the influence of the acceleration voltage and of the capacitor voltage. The influence of the acceleration voltage seems more difficult to understand than the influence of the deflection voltage. One possible explanation for this difference is that the plate capacitor is directly visible in the experiment and attracts much attention; whereas, the electron gun is hardly visible. Here, an additional representation of the electron gun may reduce the differences in understanding. Another reason could be that students locate effects of the acceleration voltage only while electrons are in the electric field of the electron gun. So, in their opinion the acceleration voltage has no further influence on the trajectory after the electrons passed the anode. They do not consider that the velocity in horizontal direction is an important determinant of the trajectory.

These issues are also one possible explanation for the results in the task, where students should rate their own hypotheses. But also a deficit in experimental competencies must be taken into account. The data shows that all students use the environment and modify the settings of acceleration and deflection voltage. But obviously they are not able to draw the correct conclusions out of the experiment. Here, an additional step in the experimental process might be helpful. A task, where students have to describe the effects of changing a parameter as well as a task where only one parameter can be modified, should raise the success rate.

Regarding the use of augmented reality as elaborated feedback, further research in intervention studies is needed. In our opinion, it can be very useful and it can strengthen the link between experiment and theory. But because it is a very new type of media in physics education students are not accustomed to it and so, it causes a great cognitive load.

References

- Ainsworth, S. (1999). The functions of multiple representations. *Computers & Education*, 33(2–3), 131–152. doi:10.1016/S0360-1315(99)00029-9
- Azevedo, R. (2005). Computer Environments as Metacognitive Tools for Enhancing Learning. *Educational Psychologist*, 40(4), 193–197. doi:10.1207/s15326985ep4004_1
- Betrancourt, M. (2009). The Animation and Interactivity Principles in Multimedia Learning. In R. E. Mayer (Ed.), *The Cambridge handbook of multimedia learning*. Cambridge: Cambridge Univ. Press.
- Fund, Z. (2007). The effects of scaffolded computerized science problem-solving on achievement outcomes: a comparative study of support programs. *Journal of Computer Assisted Learning*, 23(5), 410–424. doi:10.1111/j.1365-2729.2007.00226.x
- Hmelo-Silver, C. E., Duncan, R. G., & Chinn, C. A. (2007). Scaffolding and Achievement in Problem-Based and Inquiry Learning: A Response to Kirschner, Sweller, and Clark (2006). *Educational Psychologist*, 42(2), 99–107. doi:10.1080/00461520701263368
- Kirschner, P. A., Sweller, J., & Clark, R. E. (2006). Why Minimal Guidance During Instruction Does Not Work: An Analysis of the Failure of Constructivist, Discovery, Problem-Based, Experiential, and Inquiry-Based Teaching. *Educational Psychologist*, 41(2), 75–86. doi:10.1207/s15326985ep4102_1
- Krause, U.-M., Stark, R., & Mandl, H. (2004). Förderung des computerbasierten Wissenserwerbs durch kooperatives Lernen und eine Feedbackmaßnahme. *Zeitschrift für Pädagogische Psychologie*, 18(2), 125–136. doi:10.1024/1010-0652.18.2.125

- Lowe, D., Newcombe, P., & Stumpers, B. (2013). Evaluation of the Use of Remote Laboratories for Secondary School Science Education. *Research in Science Education*, 43(3), 1197–1219. doi:10.1007/s11165-012-9304-3
- Mason, B. J. & Bruning, R. (2001). *Providing Feedback in Computer-based Instruction: What the Research Tells Us*. Retrieved from <http://dwb4.unl.edu/dwb/Research/MB/MasonBruning.html>
- Mayer, R. E. (Ed.). (2009). *The Cambridge handbook of multimedia learning* (Reprinted). Cambridge: Cambridge Univ. Press.
- Narciss, S. (2006). *Informatives tutorielles Feedback: Entwicklungs- und Evaluationsprinzipien auf der Basis instruktionspsychologischer Erkenntnisse. Pädagogische Psychologie und Entwicklungspsychologie: Vol. 56*. Münster, München [u.a.]: Waxmann.
- Paul, A., Podolefsky, N., & Perkins, K. (2013). Guiding without feeling guided: Implicit scaffolding through interactive simulation design. In : *AIP Conference Proceedings, 2012 PHYSICS EDUCATION RESEARCH CONFERENCE* (pp. 302–305). AIP.
- Podolefsky, N. S., Moore, E. B., & Perkins, K. K. (2013). Implicit scaffolding in interactive simulations: Design strategies to support multiple educational goals. Retrieved from <http://arxiv.org/pdf/1306.6544>
- Quintana, C., Reiser, B. J., Davis, E. A., Krajcik, J., Fretz, E., Duncan, R. G., . . . Soloway, E. (2004). A Scaffolding Design Framework for Software to Support Science Inquiry. *Journal of the Learning Sciences*, 13(3), 337–386. doi:10.1207/s15327809jls1303_4
- Shute, V. J. (2008). Focus on Formative Feedback. *Review of Educational Research*, 78(1), 153–189. doi:10.3102/0034654307313795
- van der Meij, J., & de Jong, T. (2006). Supporting students' learning with multiple representations in a dynamic simulation-based learning environment. *Learning and Instruction*, 16(3), 199–212. doi:10.1016/j.learninstruc.2006.03.007
- Zhang, J., Chen, Q., Sun, Y., & Reid, D. J. (2004). Triple scheme of learning support design for scientific discovery learning based on computer simulation: experimental research. *Journal of Computer Assisted Learning*, 20(4), 269–282.
- Zhang, M., & Quintana, C. (2012). Scaffolding strategies for supporting middle school students' online inquiry processes. *Computers & Education*, 58(1), 181–196. doi:10.1016/j.compedu.2011.07.016

Affiliation and address information

Stefan Richtberg
Chair of Physics Education
Faculty of Physics
Ludwig-Maximilians-Universität München
Theresienstraße 37
80333 Munich, Germany
e-mail: Stefan.Richtberg@physik.uni-muenchen.de

Remote and Virtual Laboratories as Part of Online Courses

Konstantin Rogozin¹, František Lustig², Sergey Kuznetsov³, Denis Yanyshhev⁴, Pavel Brom², Maxim Kiryasov¹, Alexey Ovcharov¹

¹ Altai State Technical University, Barnaul, Russia

² Charles University in Prague, Prague, Czech Republic

³ Tomsk National Research Polytechnic University, Tomsk, Russia

⁴ M.V.Lomonosov Moscow State University, Moscow, Russia

Abstract

In the last two years another important trend has become obvious – MOOCs (Massive Open Online Courses) have a great potential for the education process. They can be available for hundreds of people living in different countries. Physics education has always been and still is the main engine of human development, including the humanities. We live in a transitional era - an era of constant change in the content and instruments of education. We (teachers) have to create and deliver it. In every natural science, experimental and laboratory work should always be a part of the education process. It is the aim of this article to show a way of improving the natural sciences education using the Integrated Remote and Virtual Laboratory Environment, which is not an alternative, but they are additional features that can be used for teaching in the field of reallocation of students.

Keywords

Interactive learning instruments, Key competences, Cognitive tests, Modeling cycle; Secondary education: upper (ages about 15-19); University education Learning; Remote laboratory; Methodological support

1. Reasons for changing educational paradigm

Education has a large inertia associated with the change of instruments, carriers of educational content and especially the teacher contingent. Until now, many physics teachers believe that the use of computers in the learning process is not unnecessary at all, but even it is harmful. That it was a matter of great debate we had with colleagues at a recent conference on physical education, held in Palermo.

Our arguments were simple. The world has changed. And our students have changed too. Students have not become better, but they have not become worse. The only real space where they want to be is the virtual space. They are already interonauts (the inhabitants of the web). The only reasonable choice for us is moving to the network. And we have to meet our students there. Our students are already on the highest stage, and most of the teachers still have to climb to it.



Figure 1. We and our students

They are the next generation. They are the generation of computer games. So we have to offer them to learn physics as a computer intellectual game. They are just different. "Active learning is based on two assumptions: (1) that learning is by nature an active endeavor and (2) that different people learn in different ways" (Meyers & Jones, 1993). This means that each student should have his own educational trajectory (a student-centered approach to teaching) in which they will be allowed access to the course content. That content will be specially organized, structured and presented in a way that is easier for the students to understand and focus on what students do in relation - to their efforts to activate students' existing conceptions and at the same time - to encourage them to construct their own knowledge (Hernández, 2010) and skills for decision making.

Networking is by definition activeworking. It involves real actions for taking a given goal. That is why work on the Net may form the key competencies. Education has a great inertia associated with the change of instruments, carriers of educational content and especially the teacher community.

Our students are already at the highest stage, while most of the teachers still have to climb to it. Key competences are a new paradigm of the result of modern education. We agree with the idea that competence is "the ability to apply learning outcomes adequately in a defined context (education, work, personal or professional development)" (Shapiro, 2011).

The first and most important part of this definition suggests that competence is the result of learning. It makes us focus our attention primarily on the technique, technology and tools used in the process, as well as the ideology of their use. Another important part of the above definition is "the ability to apply learning outcomes". It means that students should be ready to apply their skills in a real situation. In accordance with the basic principle of cognitive psychology (Sternberg, 2006) competences are formed within the framework of activities that are directed to reach the goal. This means that the learning process should be applied to the tasks in which learners make decisions in situations which are close to real. In our opinion it can be organized as interactive work using MID – devices.

2. Remote laboratories

Remote laboratories are still very new (Fratichek Lustag, 2013). They are real laboratories with real experiments, however, anyone can access these laboratories, whenever and from wherever they wish via an internet connection using freely available browsers like Internet Explorer, Mozilla Firefox, Opera, etc. Remote laboratories can be used as a set of experiments and tasks for students but they may also serve as an experiment database for teachers or lecturers, who may just include the desired experiment at any time in their lecture or seminar.

Remote experiments also have a reservation function, it is possible to reserve them for a certain time on a name and password. Using the remote laboratories, students can on their own explore the development and behavior of each experiment and deduce what can be measured and verified. A remote experiment can, however, be set up as a standard laboratory task, where students measure and record data, transfer them to their computer via the internet and finally assess the data, draw them into graphs and create appropriate tables, verify various curves etc.

It has been practically proven that it is possible to submit written reports from a completely different station via the internet. Try for yourselves for example our experiments in our laboratory at <http://www.ises.info> (tasks involving springs, damped, with an excitation force etc., diffraction on a slit, the photoelectric effect, solar energy, controlled water level, etc.).

The still growing remote laboratories can be found in Prague at the Charles University Faculty of Mathematics and Physics (<http://www.ises.info>)

3. Virtual laboratories

In virtual laboratories you can find virtual experiments, virtual models, applets, flash animations, etc. They are programs available from a local computer or which can be ran via the inter-net. There are countless applets and flash animations to be found on the internet. But some points of interest are for example: <http://www.walter-fendt.de/> (relatively simple applets), or <http://phet.colorado.edu/> (excellently made, although somewhat complex applets, truly unique simulations). It is possible to use these simulations in virtual experiments which simply cannot be done in a real laboratory (for example changing gravity, research of micro- and macrospace, work with dangerous substances, etc.). You can perform truly fascinating experiments, tests and measurements using these virtual laboratories (Fratichek Lustag, 2013).

Available simulations do not enable us to work with the data, but it is possible to observe graphical outputs react to changes in input data, etc. The latest advance in simulations makes it possible to export and import data into the simulations.

We shall introduce working with such an applet on “Oscillations in a Spring” (free oscillations, damped oscillations, forced oscillations) virtual experiment. A very well done animation of the oscillations in a spring makes it possible to interactively change many parameters in this experiment – it is possible to set weight, spring stiffness, spring length, then it is possible to set outside parameters like damping or excitation force. Furthermore it is possible to set the gravitational constant (the oscillation happens on Earth, on the Moon, on Saturn, etc.).

4. Integrating MOOCs, Remote and Virtual Laboratories

In this part we would like to deal with using the MOOCs, remote and virtual computer experiments, hand-made experiments, project-based teaching, integrated teaching, e-learning, multimedia environment, etc. to transform teaching in laboratories and start to think about changing the whole way of teaching natural sciences...

Let us think that you are teaching about oscillations in a spring – free, damped, driven and others, just about everything you can teach about oscillations in a spring. So far we have introduced three types of laboratories, traditional, remote and virtual, but we have not forgotten about hand-made laboratories. Each of the afore-mentioned types of laboratories has its undeniable advantage.

However, we would like to go even further. Let us try to research one problem, one issue using each of the three types of laboratories. Each student should choose for him- or herself which type of laboratory to use

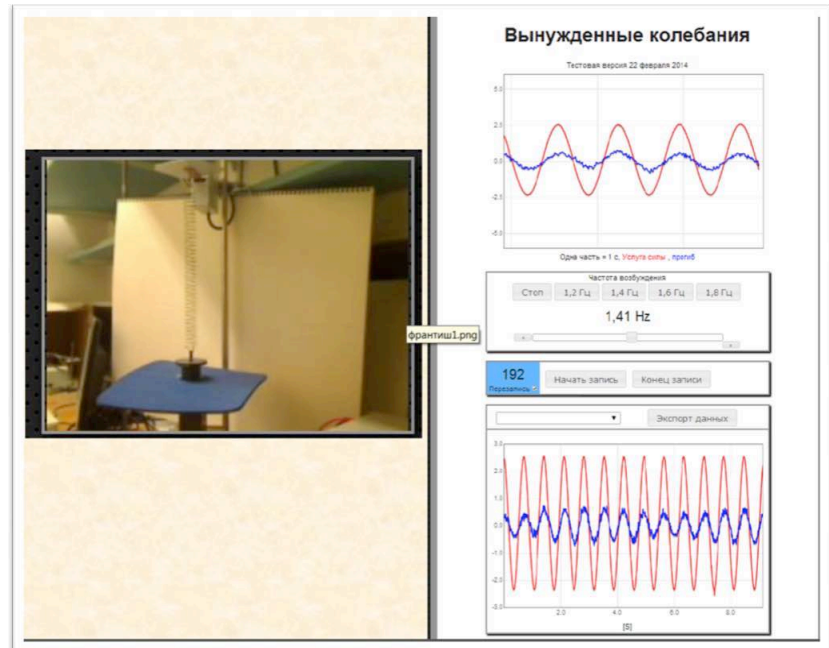

Figure 2. View on remote experiment

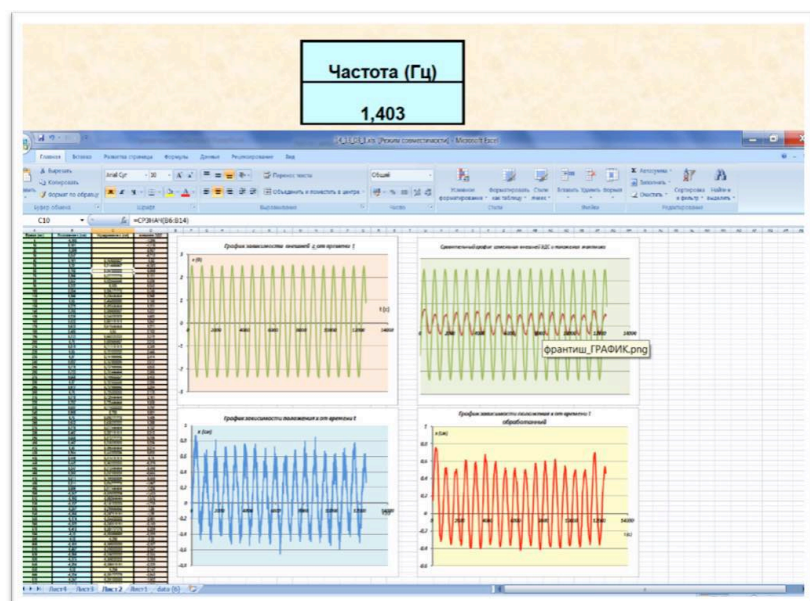

Figure 3. View on data and graphs

The class should split into groups which deal with the problem MOOCs, remotely or virtually. If there is no real experiment at hand, it is possible to choose a real but remote experiment. Students can “conduct” an experiment via the internet. Online camera shots are available along with the option to control the various parameters of the experiment. After the measurements students can easily transfer the collected data to their computers and process it there.

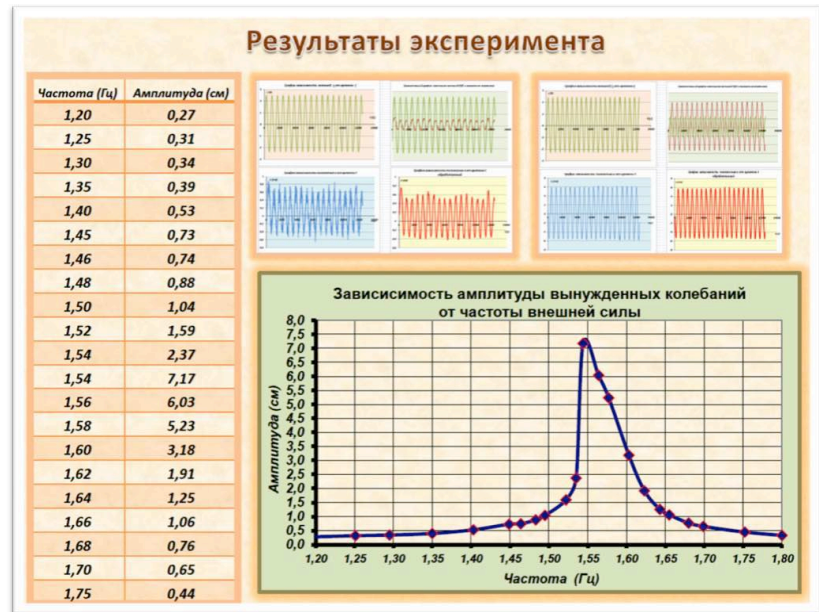

Figure 4. View on the results of experiments

Or it is possible to try those experiments with the students during the lesson or make it their homework to review their knowledge of oscillations in a spring. Let the students measure the stiffness of a spring via the inter-net (Of course the address has been announced during the lesson.), let them find out the oscillatory period, the resonance frequency and study the phase characteristics of displacement and excitation force. There are more than enough tasks which the students will be glad to solve, simply because it is “on the net.” This has been empirically verified.

Traditional experiments with a spring do not actually require a computer, only a stopwatch and a ruler. It should be no trouble to find out the oscillatory period, amplitude, spring stiffness, damping, etc. However, if we use a computer in the experiment, we will additionally get records of harmonic oscillations, damped oscillations and maybe even driven oscillations in time (The measuring system can excite the weight on the spring for example by harmonic electric/electromagnetic force.). The computer will record everything and the student then only has to process the data.

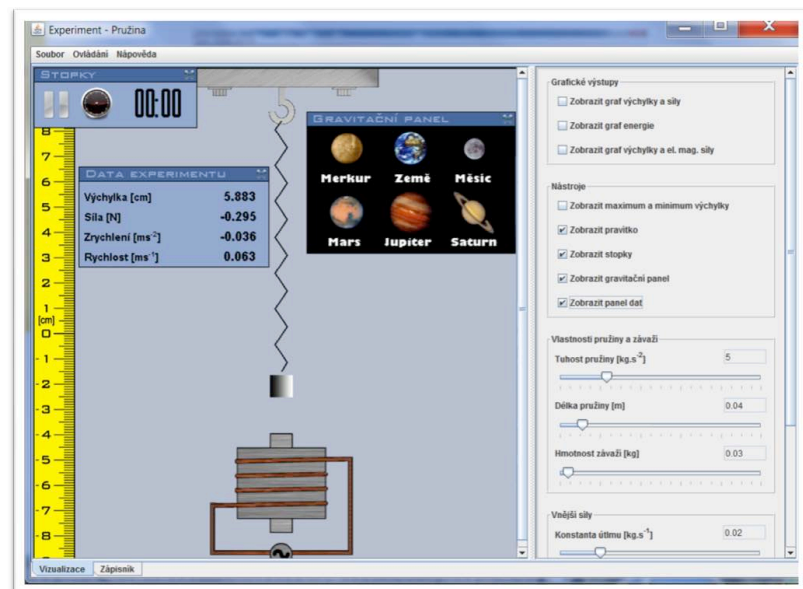

Figure 5. View on applet 'Simulation of spring oscillation'

In the end the student will work his way to the harmonic, driven and damped oscillation in a spring equations. That is about as far as the real local experiment can go.

Students shall conduct virtual experiments. And those are far from boring. They will try to work with a virtual spring as they would with a real one. Only this time they will have the option to change gravity and air resistance and have several different springs at hand with various lengths and stiffness values, various weights etc. Therefore if a student should decide to use this virtual reality, he would have a much more flexible experiment available to him.

Students of this group are quite likely to bring more valuable data and conclusions. YES, they would miss the real experience with the spring, but we do not wish to deny them this. They will confront their results with the group which worked with the real spring. A virtual simulation, for example our “Oscillations in a Spring,” allows not only for virtual experiments, but the new version also makes it possible to import data and compare them, fit the data from a traditional or remote experiment and from the virtual one.

Introduction of computer simulation and remote experiments into the course in 2013 increased student motivation which resulted in a 10% increase of grades as compared to the students who took the courses in 2012/

References

KEY COMPETENCES FOR LIFELONG LEARNING. European Reference Framework (2007) Office for Official Publications of the European Communities, Luxembourg:

Fratichek Lustag (2013) Easy to use remote experiments WITHOUT Laboratory system. *Sbornik conference information and communication Technology and Education, Vydal Ostrvaska Univerzita, 146-153*

Rogozin Konstantin, Kuznetsov Sergey, Kondrashova Diana & Irina Lisina (2014) Cognitive Test as a Tool for Physics Learning. *Proceedings of the world conference on physics education 2012, 2014 Ankara, Turkey, 607-615*

Rogozin Konstantin (2014) Physics Learning Instruments of XXI Century. *Proceedings of the world conference on physics education 2012, 2014 Ankara, Turkey, 913-923*

Shapiro, H., Lauritzen, J.R.K., & Irving, P. (2011) *Emerging skills and competences: A transatlantic study*. Danish Technological Institute, GHK, Brussels.

Sternberg, R. J. (2006) *Cognitive psychology (4th ed.)*. Belmont, CA: Thompson Wadsworth.

Affiliation and address information

Konstantin Rogozin
Altai State Technical University, Faculty of Special Technologies
Chair of Physics, Lenin St., 46, 656038 Barnaul, Russia
E-mail: krogozi@mail.ru

František Lustig, CSc
Matematicko fyzikální fakulta UK Praha
Kabinet výuky obecné fyziky, Katedra didaktiky fyziky
Ke Karlovu 3, 121 16 Praha 2, Czech Republic
fl@plk.mff.cuni.cz

On-line Coursework for Students of Optics

**Konstantin Rogozin¹, Sergey Kuznetsov², Irina Rogozina¹, Denis Yanyshv³,
Vesselina Dimitrova⁴, Nadezhda Isaeva¹, Ekaterina Sorokina¹**

¹*Altai State Technical University, Barnaul, Russia*

²*Tomsk National Research Polytechnic University, Tomsk, Russia*

³*M.V.Lomonosov Moscow State University, Moscow, Russia*

⁴*St.Kliment Ohridski University of Sofia, Sofia, Bulgaria*

Abstract

Historically, learning physics was carried out under the direct participation the head of the educational process. Usually it was a teacher, who imparts knowledge and skills to their students. Modern network instruments for learning physics allow using all Internet information resources accumulated by Humanity and learn physics using PCs, tablets and mobile phones at any place and at any convenient time. However, a teacher of physics cannot be excluded from the educational process. Modern digital technology can serve as a support for the traditional course. This article is dedicated to the example of this approach of using distance form student work.

Keywords

Interactive learning instruments, Key competences, Cognitive tests, Modeling cycle.

1. The Inter-University Teaching and Research Resource Center «Modern Physics»

Modern informational, intellectually saturated with interactive learning instruments and educational technology requires a work of the specialized creative professional teams both at the stages of their creation and the operation. This challenge is not possible even in the framework of some the best Universities, which have their own traditions and experience in education. Historically in Russia, there are a limited number of possibilities, where university professors could show created pilot learning tools to their colleagues.

Moscow State University, Altay State Technological University and Tomsk National Research Polytechnic University (ones of the largest teaching and research universities in Russia) had entered into the agreement on the formation of the Inter-University Teaching and Research Resource Center «Modern Physics».

In that agreement it is written that the main activities are:

- Carrying out the research on the development and implementation of modern information interactive technologies with media saturation in the educational process of university and schools;
- Accumulation, standardization and adaptation to MID devices in a single resource center for the best development of teachers;
- Ensuring access of students and schoolchildren to information resources placed in the center, as well as the best world information resources with the support of the Russian-language interface;
- Rendering methodical assistance to teachers;
- Promotion of the achievements of modern Physics.

Resources presented in this article are created within the framework this project.



Figure 1. Top of the Optics page

2. Student resource materials of Optics

At the moment, the resource contains (<http://distant.msu.ru/course/view.php?id=183>): a) question bank contains 981 original task; b) handbook on the Optics - 108 pages; c) full text course of lectures - 350 pages; d) 13 presentations of lectures; e) 12 specialized tests; g) 4 notes; f) one research project; h) several thousand different service files.

Handbook on Optics, full text course (lectures), presentations of lecture are traditional forms of representation of a physical content. Their volume is fully meets the requirements of the Ministry of Education of Russia. Another characteristic them is that for performing the proposed further control tasks not required any other materials.

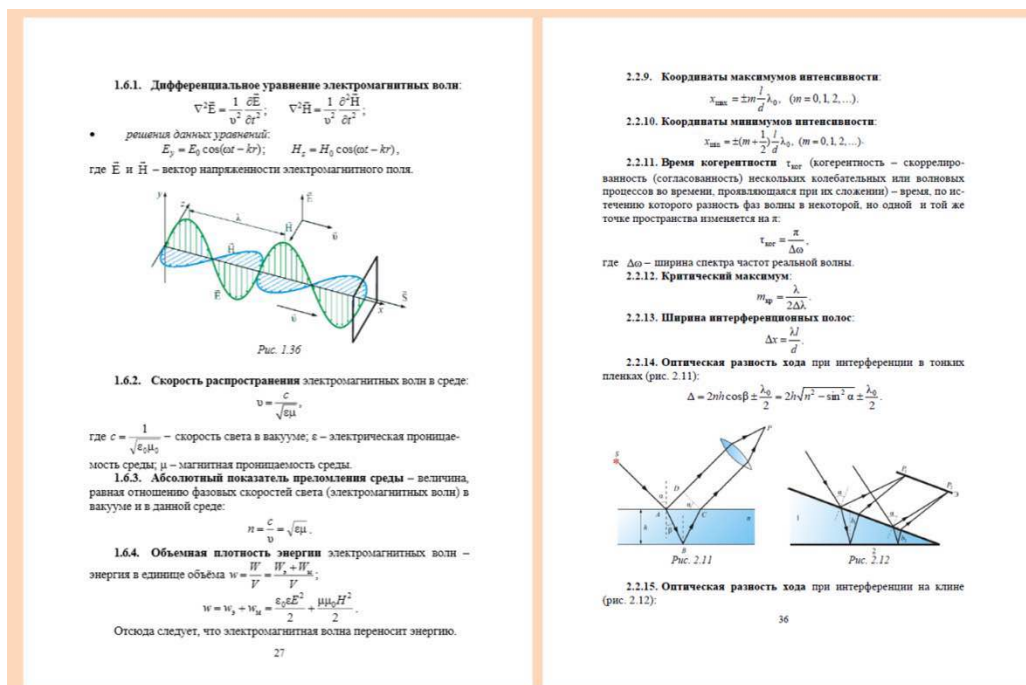

Figure 2. Two of pages of hand book on Optics

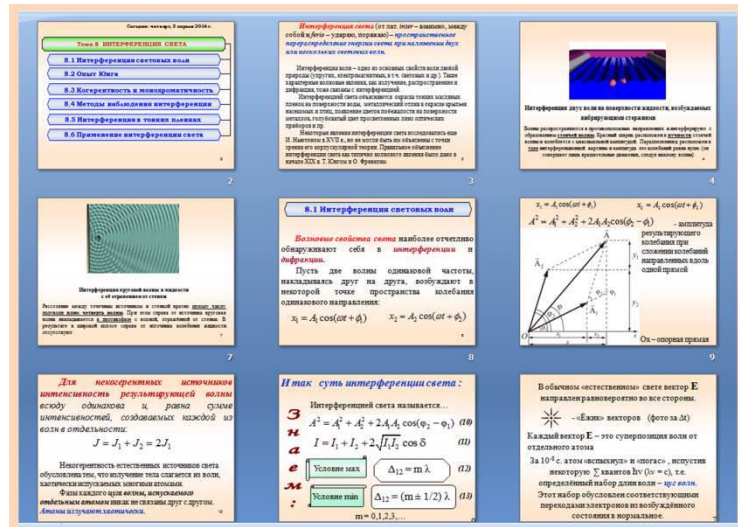

Figure 3. Several slides of presentations

On-line coursework was part of the course which included other kinds of training activities (lectures, lab works and practical trainings). Its share in the total final rating was 50 per cent. In addition (texts and presentations) student materials contain video demonstrations of classical physical experiments and explanations of the most important parts of the course as well as control and measuring materials. Control and measuring materials are in the form of tests included up to 50 assignments made with using cognitive and interactive technologies. They were placed in LMS MOODLE in the website of the Moscow University (<http://distant.msu.ru>).

3. Control and measuring materials

The course contained three sections – Geometric, Physical and Quantum Optics. Each section had four subsections in accordance with four different ways of presenting physics content:

- 1) Conceptual Technique is implemented in a verbal way in forms of definitions, rules, physical laws, which are generally accepted;
- 2) Symbolic Technique (apparatus of symbolic links) of formal relations between physics varieties;
- 3) Technique of Theoretical Problem Solutions is formed on the basis of ownership of the Technique of Concepts, Symbolic Technique of formal relations and elements of other code systems (graphs, charts, figures and tables);
- 4) Technique of Computer Simulation represents dynamic models of physics phenomena.

In other words, online-coursework involved successful passage of 12 (4 in each section) specialized tests and one research test for those students who were interested in getting high final points.

4. Key competences

“Key competences” are a new paradigm of the result of modern education. We agree with the idea that competence is “the ability to apply learning outcomes adequately in a defined context (education, work, personal or professional development” (Shapiro, 2011). The first and most important part of this definition suggests that competence is the result of learning. It makes us focus our attention primarily on the technique, technology and tools used in the process, as well as the ideology of their use. Physics education has always been and still is the main engine of human development, including the humanities. Since Aristotle, physicists have been solving the problems of teaching and have been finding solutions to problems that have universal significance, and which can be transferred to other areas of knowledge.

Another important part of the above definition (“Key competences”) is “the ability to apply learning outcomes”. It means that students should be ready to apply their skills in a real situation. In accordance with the basic principle of cognitive psychology (Sternberg, 2006) competences are formed within the framework of activities that are directed to reach the goal. This means that the learning process should be offered the

works in which learners make decisions in situations which are close to real. Students have to work with models, which main characteristics and properties are similar to real phenomena. There is only one possibility as a result of their simultaneous presentation. It uses components of different code systems (verbal, non-verbal, as well as structures that contain both elements thereof) in modern terminology “multimedia”. Moving the theoretical development of physicists-scientists as well as using their experience with the modern digital instruments and technology of multimedia learning students can form competence in the “fundamental basic skills of language, literacy, numeracy and in information and communication technologies is an essential foundation for learning, and learning to learn supports all learning activities” (Key, 2007).

5. Cognitive tests

In 1995 Malcolm Wells, Hestenes and Swackhamer (1995) proposed a new method of organizing the process of physics teaching. This method can be regarded as a way to teach systematic scientific inquiry. They coined the term “modeling cycle” for the integration of systematic modeling into the learning cycle. The central idea in the modeling approach is that you understand a phenomenon by creating or adapting a model to describe it. This method of teaching physics requires three successive stages:

- Representation of the system and its variables is the first step in constructing a model;
- The next step is specifying relations among the variables and how they change;
- Finally, validity of the model is established by comparing it with empirical data on how the system behaves.

In our point of view, the best way of learning is an active job. Using the Internet is by definition an interactive job. We used the idea of “modeling cycles” when we are creating physics cognitive tests. Based on the idea modeling cycles we have combined in one educational tool, important and effective content (in our opinion), namely, that can be used in a global network. The result is a multimodal multitasking PC-and tablet- network-oriented educational resource of physics learning, designed to work in real time in platform MOODLE. Physical content thus organized and represented in a certain way, adapted to modern interactive communication technology equipment, in the form which we call “network modeling learning cycles” or “Cognitive tests”.

In our view, the cognitive test involves a special way of constructing tasks themselves as elementary modeling cycle. Each of these cycles includes a complete listing of possible situations, which are necessary to describe the physical phenomenon.

The basic principle of physics is the superposition principle, implying that any complex phenomenon can be represented as a simple combination of its component parts. Therefore, it is essential to allocate these parts and their relationships (the first part modeling cycle). Students must learn to make decisions separately for each side of a physical phenomenon considering the existing links (second part modeling cycle).

Another important point is the following one: “In learning process, students are allowed to make mistakes as many times as they like”. Students should not be afraid of their mistakes and learn from them. That is why before the control test is always assumed to have a trial test with samples of tasks.

6. One example.

New network technologies especially those based on the Internet stimulate extensive search of new approaches to teaching physics. The main advantage of these technologies is their ability to deliver and control great volumes of educational materials, which significantly exceed those used in traditional training. This feature of network technologies is especially advantageous for organizing on-line coursework.

This applies to the representation of control and test materials, usually called tests. Modern technical capabilities make it easy to implement ideas of modeling cycles and cognitive tests. This can be done with the help of interactive and multimedia tools that learning environments (such as Moodle) are available.

Here we give an example of the tests on Wave Optics in Symbolic Technique (apparatus of symbolic links) of formal relations between physics varieties. This test was carried out in the fall semester of 2013.

We have allocated 48 formulas that students should be able to use for educational purposes. In our opinion, students cannot remember them, to reproduce in writing. Our demands have to teach students to find quickly these formulas in the training materials for the required use. In the trial and control tests formulas are represented in the form of three types of jobs, examples of which are shown below.

All tasks are adapted to the use of digital client devices such as tablets and mobile phones. Students do not need to type any information from the keyboard. In the course of the job you want to select, mark, or move the image right decision. All tasks are adapted to the use of digital client devices such as tablets and mobile phones.

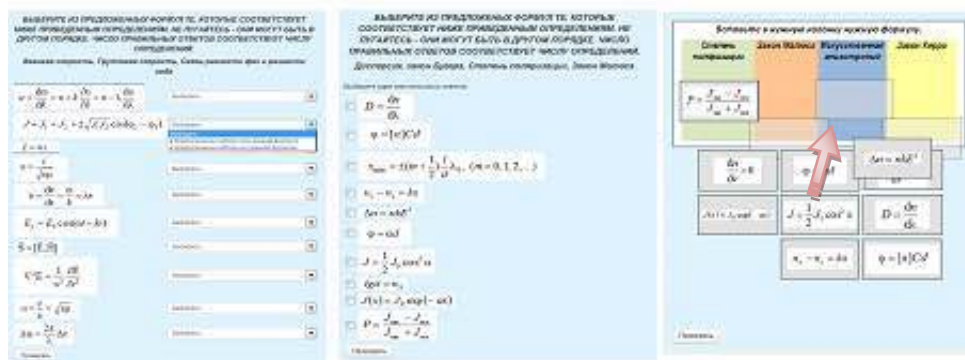

Figure 4. Example of tasks (formulas on Wave Optics)

Students do not need typing any information from the keyboard. In the course of the job you want to select, mark, or move the image right places. In the Tasks required to choose four correct answers out of 10 proposals. In this case, students will not be able to guess the correct answers. The only choice for students is to using the Hand book on Optics offered for them. Another reason which causes students to use educational materials is the requirement of the teacher. It is usually that a minimum valid result for test is 75 points. The results presented below the trial (left) and control (right) tests.

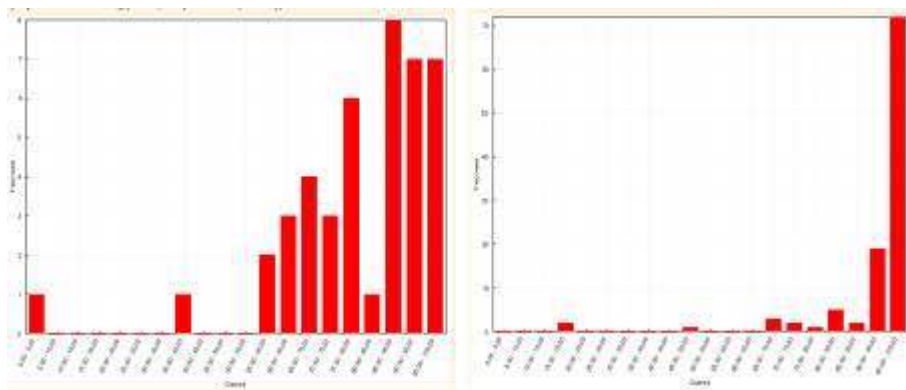

Figure 5. Results the trial (left) and control (right) tests

Control test consists of 36 tasks. Within 90 minutes, students should take 360 decisions. As shown in the histogram of the students do. The average test result on a group of 150 students of more than 94 points. In our opinion, it is impossible to estimate other than the presence of students required competencies.

7. Student Results

All measurement and control materials are based on the proposed student texts (books and references) or slides (PowerPoint Presentation). Recent placed on the same web page on which the tests (Figure 4).

At the page are entrances to both type offered working tests (trial – "пробный" in Russian and control – "зачетный").

The proposed test is accompanied by an emotional appeal to the students. Example. In the figure we proposed tests in Conceptual Technique on Wave Optics. Russian phrase ("Когда понимаешь – действуюешь правильно. Мы хотим, чтобы так и было!!!!!!") means in English the following: "When you understood you are acting correctly. We want to be so!!!!!!!"

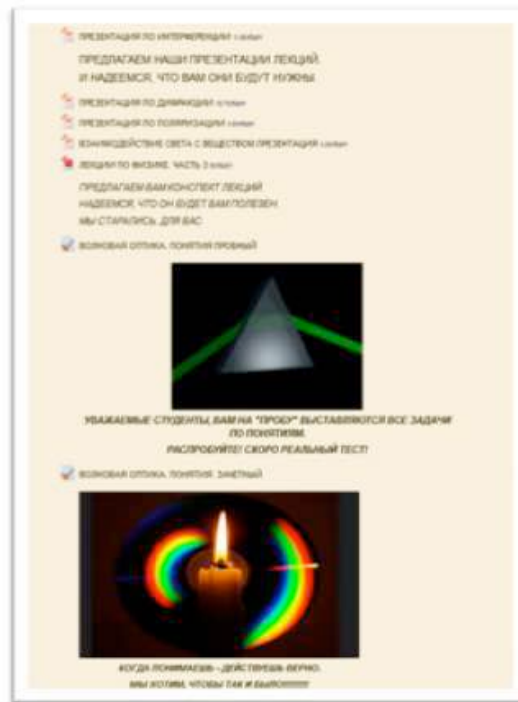

Figure 6. One part of a web page

Below we present the results of the trial tests. Typically, the average result in them is no more than 50 points out of 100.

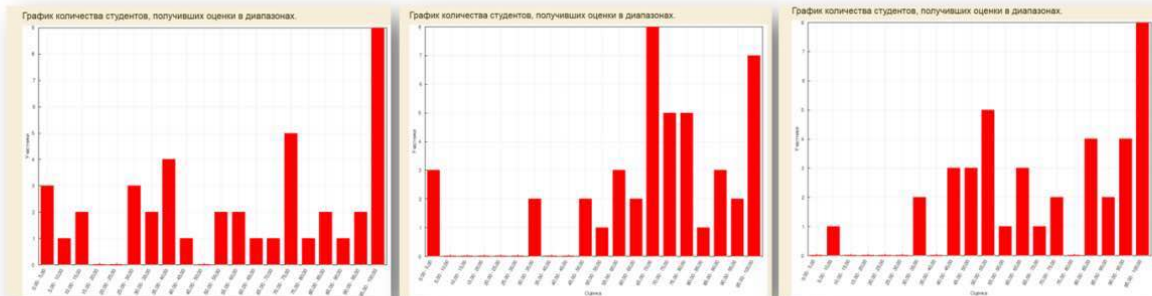

Figure 7. Results of the trial tests

In the next figure, we present typical results of control tests.

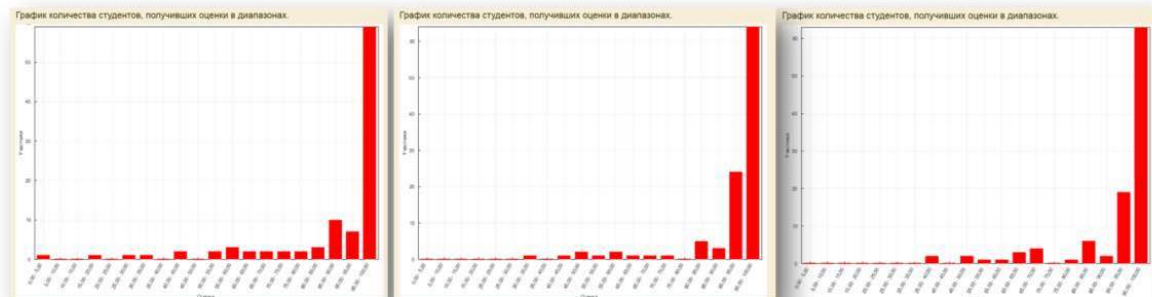

Figure 8. Results of the control tests

We set the minimum level of passing control test in 75 points. Level evaluation "A-" usually starts with 93 points. This leads to the fact that more than 40 percent of students had the maximum score (100 points). It shows two things:

- tasks done correctly;
- students can and wish to work on the proposed algorithm.

After the course (182 students) we asked if they found their on-line coursework useful to preparation for practical trainings, labs and exams. And 97 percent of student said "yes".

References

- KEY COMPETENCES FOR LIFELONG LEARNING. European Reference Framework* (2007) Office for Official Publications of the European Communities, Luxembourg:
- Redish, E.F. (2003) *Teaching Physics With the Physics Suite*: John Wiley & Sons, Inc. Retrieved from <http://www2.physics.umd.edu/~redish/Book/>
- Rogozin Konstantin, Kuznetsov Sergey, Kondrashova Diana & Irina Lisina (2014) Cognitive Test as a Tool for Physics Learning. *Proceedings of the world conference on physics education 2012, 2014 Ankara, Turkey*, 607-615
- Rogozin Konstantin (2014) Physics Learning Instruments of XXI Century. *Proceedings of the world conference on physics education 2012, 2014 Ankara, Turkey*, 913-923
- Shapiro, H., Lauritzen, J.R.K., & Irving, P. (2011) *Emerging skills and competences: A transatlantic study*. Danish Technological Institute, GHK, Brussels.
- Sternberg, R. J. (2006) *Cognitive psychology (4th ed.)*. Belmont, CA: Thompson Wadsworth.
- Wells, M., Hestenes, D. & Swackhamer, G. (1995). A modeling method for high school physics instruction. *American Journal of Physics*, 63, 606–619.

Affiliation and address information

Konstantin Rogozin
Altai State Technical University
Faculty of Special Technologies
Chair of Physics
Lenin St., 46, 656038 Barnaul, Russia
E-mail: krogozi@mail.ru

Designing an Educational Methodology to Teaching Thermal Equilibrium Using ICT

Rubén Sánchez Sánchez

Centro de Investigación en Ciencia Aplicada y Tecnología Avanzada del Instituto Politécnico Nacional. Unidad Legaria. México City, Mexico,

Abstract

The aim of this paper is to propose a possible teaching methodology, based on observation of dynamic events but not through experiments in the real world, but through computer simulations written in "flash" language. The student observes the simulation of thermal equilibrium between two substances and then it is possible for him to try to build a new knowledge from prior knowledge. Basically we have the following scheme of work with students: First the teacher forms teams of about four, then asked to make a prediction about the behavior of the substances involved in the phenomenon of thermal equilibrium (phase of prediction), then the students are asked to observe the physical phenomenon with the aid of computer simulations. As a next step the group made a discussion about the results observed in the last step, and finally, in coordination teacher takes a common exposure explanations of the phenomenon by computer and makes it to a synthesis of the above activities and to a explanation of the observed physical phenomenon. This cycle is known as PODS cycle by its acronym: Prediction, Observation, Discussion and Synthesis. This method of study is based on the constructivist principle that students construct their own knowledge based on their experiences with the physical phenomenon, although we have here replaced it by a simulation. This methodology was originally raised for students of the College of St. Elizabeth of Hungary in Bogota, Colombia by Diego Fernando Becerra Rodríguez, a master's degree student in Physics Education of Applied Research Center for Advanced Science and Technology at the National Polytechnic Institute – Legaria Unit, of Mexico City. He thus proposed that the institution in which the methodology has not applied any calorimeter. We hope that the presentation of this learning methodology is useful for teaching basic concepts of thermodynamics, in schools budget for the purchase of laboratory resources.

Keywords

University education, ICT including multimedia, teaching thermodynamics.

1. Introduction

During the training process and the teaching practice in the St. Elizabeth of Hungary School in the city of Bogota, (Colombian school who teaches at Middle and Senior students aged on average between 15 and 19 years of age). It has been shown that students have conceptual flaws related to the understanding and realization of experimental practices for thermal equilibrium of two substances. It has made a detailed observation on students on theoretical and practical issue of calorimetric and thermal equilibrium aspects. Proposals for experimental physics class practices, little motivation and perceived fear when they are addressed. Such attitudes were visible when the tenth graders were inquired about the background it had to address classroom activities related to thermodynamics. They recurrently expressed through verbal language, their dissatisfaction with the activities of the class; the same way students feel that the materials are there in the laboratory are not sufficient or are best placed to develop experimental practices and therefore there is also a fear of damaging parts of the laboratory.

In this work a new methodology for teaching physics, applied to traditional concepts of heat, temperature and thermal equilibrium forming the first law of thermodynamics is proposed. Our strategy is based on PODS cycle, as suggested by Sokoloff and Thornton but unlike them, we rely on computer simulation processes to overcome the gap of lack of real laboratory equipment. Since in Colombia as in many parts of the deficiencies that have schools in the economic sphere, often deprives them of having and maintaining complete laboratory equipment, as would be the case of the American universities where researchers work as Sokoloff, Thornton, *et al.* Thus, in this paper, we propose an alternative to Active Learning approach

Sokoloff *et al.*, replacing real experiments with computer simulations, but above all, preserving the PODS cycle and methodology based on Piaget's constructivism, which focuses on is the student (not the teacher or the textbook) which "builds" knowledge.

Continuing deficiencies observed at Middle Superior (in Mexico or the vocational equivalent CECYT [for its acronym in Spanish: *Center for Science and Technology Studies* of the National Polytechnic Institute], or failing high schools); has also become an exercise in observation oriented attitudes of students (Colombia), where little motivation and boredom in physics class was perceived, also misconceptions related to heat and temperature terms were perceived.

Cabero (1998), Chen (2010), Orozco (2011), McDermott (2001), Llorente (2010), have taken advantage of the virtues that offers assisted learning physics with ICT, and the results have been very good, as can be seen in the references.

2. Justification

It is appropriate for teachers and researchers contribute to the design and development of proposals for innovative classroom using ICT to enable better development of the teaching and learning, to enable students to interact with them, and in this way complement lectures. It is also considered to involve relevant ICT learning in the classroom because they may enhance collaborative work and the use of everyday problems.

For these reasons the proposal for a strategy of using the PODS cycle class supported by a virtual learning environment for the study of thermal equilibrium and heat transfer to enable students acquire skills to solve problems of this physical phenomenon.

3. Utilities

The *Wii mote* is one of the input devices common computer in the world and also one of the most sophisticated, contains an infrared camera that can track points that are pointing to it, turn on Bluetooth and send signals to a computer that is connected to the *Wii mote*. By a free use interface, which is in the website <http://johnnylee.net/projects/wii/>, you can gauge the perception of these access points and low cost interactive whiteboards.

4. PODS cycle for learning Physics

Over the years research has been conducted that prove that when teachers oriented classes in a traditional way (understanding this way of teaching as purely focused on teaching classes and continuous repetition of exercises and problems in this application by) students fail to internalize concepts but instead just memorized mathematical processes. McDermott & Shaffer (2001) comment that after students take a typical subject, many of them are not in the ability to contextualize situations apply physical and mathematical formalisms that have learned to different situations they have memorized, so Margalef & Alvarez (2005) suggest in their publication design teaching strategies that engage students in active participation in their own learning process.

However, Thornton and Sokoloff (2004) propose that students work collaboratively in teams of three or four, using eight steps, which can guide the experimental sequence to obtain positive results. These eight steps they used in their methodology are:

1. Describing demonstrations and do in the classroom without taking measurements.
2. Students who register in person at leaf predictions about the phenomenon of study are requested. This is collected, and is identified by the name of each student. (Students ensure that this sheet does not qualify, even if in some courses they are rewarded with the assistance and participation in these sessions.
3. Students are grouped in small discussion groups with one or two of its neighbors.
4. The teacher is in charge of choosing the common predictions of the class.
5. Students record their findings in a final sheet prediction.
6. The teacher makes demonstration measures (at Graph regularly made by laboratory tools based microcomputers) relying on existing devices in his lab (multiple monitors, LCD or computer projector).
7. Some students describe the results and discuss them in the context of the show. Students can fill out a score sheet, identical to the predictions, which can lead to future studies.

8. Students, instructor or both discussed analogs physical phenomena with different data (*i.e.*, different physical situations based on the same concepts).

5. The use of ICT in teaching and learning of Physics

To Cabero (1998), the information technology and communication (ICT) impact in different areas of society, these technologies also called communication channels, slowly have been penetrating education, *i.e.* that have been taken as tools that are included in training experiences through studies have been showing their impact on the training of students, although it is noted that these are just tools that are part of curriculum components and their use, success or failure is clearly guided by the person using it, and correct articulation that give the teacher and the student in a teaching-learning process. Also, the new communication channels are not intended to delegitimize codes, social contexts and tools such as textbooks, just offer them new ways, new possibilities to access information and communication can also be found by other means.

An ICT tool most commonly used in physics education is the educational software and virtual laboratories, this involves the use of digital educational materials supported by simulations that allow students to visualize the physical principle and even interact with situations through digital dynamic tools.

That is why the web is a series of virtual labs and digital elements as are provided in <http://www.myphysicslab.com/>. In addition, the virtual labs can be written in *Easy Java Simulations (EJS)* developed and written by Francisco Esquembre, professor of Murcia's University in Spain <http://www.um.es/fem/EjsWiki/Main/WhatIsEJS>. You may find that "... *EJS is a software tool designed to create simulations to reproduce, for educational and scientific purposes, or a natural phenomenon through the visualization of the different states can have ...*"

6. Methodology

The instructional design consists of three phases:

1. Preparation phase.
2. Implementation phase.
3. Phase analysis.

We describe each of these steps, in the following paragraphs:

Preparation phase: Initially, a literature review in which were observed and classified the issues, like the materials used in the construction and design of the tools was made. Secondly began with the structure and design that has the Educational software and wireless board (Wii mote whiteboard) for the components that make this part of it is built is recreated. Also pre-and posttest were applied to students is planned.

Implementation phase: Once the phase has been overcome designs and verify operation of the respective tools, we proceed to run the tools in the classroom with students, this should be taken into account: a brief introduction of what will be done, taking into account the attitude of both students and the teacher on the subject, or having clear pedagogical models to be used in the classroom strategy and allow students to interact with the tools between more activities.

Analysis phase: In this phase the data obtained in the implementation will be systematized and analyzed to determine the *Hake's learning gain factor*, coming to conclude whether the tools met the objectives to determine the strengths and weaknesses of the classroom strategy, tools and application.

7. For the implementation of the learning proposal

As mentioned above what is done in the work is the implementation of some ICT tools using the methodology proposed in the PODS cycle but clearly not taking part in the research cycle PODS as it focuses on the observation of the world natural and in this paper due to lack of resources and laboratory phenomenon is analyzed from an educational software.

The way in which it intends to apply the didactic proposal is posed Sokoloff and Thornton, major exhibitors Active Learning and PODS cycle before starting the cycle is recommended that students work collaboratively in groups.

- a) Previous questions, pretest questions that will be discussed and analyzed by each of the groups prior to the implementation of technological tools are provided.
- b) The teaching strategy is implemented board tools - software, at this stage students will compare the expected results "predictions" with the results of the "Virtual Lab" software.
- c) Further questions about the implementation of the strategy, posttest were raised in order to discuss in working groups, and changes were observed with respect to the previous answers suggested students.
- d) Reflections of the relevant agreement with the observations made and the conclusions that can reach students, after implementing the strategy along with the tools that compose it.

8. Some questions of the test

There are some conventional books such as the thermodynamics of Sears and Zemansky, which can help us to review the content of the topics to be covered, to teach the zero law of thermodynamics and the difference between heat and temperature.

We present here, some of the questions that we apply to the students; the original test was of twenty-four. But here, we can appreciate the approximation of every one.

1. Does the concept of heat is the same concept as the temperature?
 - a) Yes
 - b) No
 Why? _____
2. It has a plastic object to a temperature of 5°C and an iron (Fe) also at a temperature of 5°C , if Do you touch the two objects which will be cooler?
 - a) The iron
 - b) The plastic
 - c) Just the same, because they both have the same temperature
3. If the same amount of heat is provided during the same time two equal masses, one of copper (Cu) and steel, which of the two bodies will be hotter?
 - a) The steel
 - b) The copper
 - c) Both will be at the same temperature
4. If two substances one gold (Au) and a silver (Ag) with the same mass have to increase by 10°C temperature, to which of the two should be provided with more amount of heat?
 - a) More to gold
 - b) More to silver
 - c) Equal amounts
 - d) None of the above
5. If two equal masses of different substances are supplied with the same amount of heat, is the increase in temperature the same for both?
 - a) Yes
 - b) No
 Why? _____

9. Analysis and results

1. We elaborate a Student's t test for the first question to estimate the degree of difference in leaning between the experimental group (group B) and the control group (group A). The results are showed in the following table.

Table 1. The Student's t test for two samples not paired for the first question of the test

	Group A	Group B
Average	81.25	45.4166667
Variance	994.8214286	1901.964286
Observations	36	36

Pearson's correlation coefficient 0.253017213,
 Hypothetic difference between averages 0,
 Degrees of freedom 35,

Students' t value 4.583071457,
 $P(T \leq t)$ two tails 5.6134e-05,
 Critic value of t (two tails) 2.030107928.

2. We repeat the same procedure for the second question, and here is the analysis of the Student's t test, the results are written in table 2.

Table 2. The Students' t test for two samples not paired for the second question of the test

	Group A	Group B
Average	77.77777778	25
Variance	1777.777778	1928.571429
Observations	36	36

Pearson's correlation coefficient 4.21014e-17,
 Hypothetic difference between averages 0,
 Degrees of freedom 35,
 Students' t value 5.201506947,
 $P(T \leq t)$ two tails 8.71932e-06,
 Critic value of t (two tails) 2.030107928.

3. The Student's t test for the third question is showed in table 3.

Table 3. The Students' t test for two samples not paired for the third question of the test

	Group A	Group B
Average	47.22222222	19.44444444
Variance	2563.492063	1611.111111
Observations	36	36

Pearson's correlation coefficient 0.519400497,
 Hypothetic difference between averages 0,
 Degrees of freedom 35,
 Student's t value 3.668996929,
 $P(T \leq t)$ two tails 0.000803706,
 Critic value of t (two tails) 2.030107928.

4. The Student's t test for the fourth question between group A and B is showed in table 4.

Table 4. The Students' t test for two samples not paired for the fourth question of the test

	Group A	Group B
Average	36.111111	25
Variance	2373.0159	1928.571429
Observations	36	36

Pearson's correlation coefficient 0.6343915,
 Hypothetic difference between averages 0,
 Degrees of freedom 35,
 Students' t value 1.6733201,
 $P(T \leq t)$ two tails 0.1031805,
 Critic value of t (two tails) 2.0301079.

5. The Student's t test for the fifth question between group A and B is showed in table 5.

Table 5. The Students' t test for two samples not paired for the fifth question of the test

	Group A	Group B
Average	72.7777778	53.75
Variance	1274.920635	1599.107143
Observations	36	36

Pearson's correlation coefficient 0.708861612,
 Hypothetic difference between averages 0,
 Degrees of freedom 35,
 Student's t value 3.916478643,
 $P(T \leq t)$ two tails 0.000397251,
 Critic value of t (two tails) 2.030107928.

These are the statistical results for the Student's t . In most cases it is observed that the experimental group had better learning outcomes than the control group. As the test methodology that is more efficient in teaching physics than the traditional methodology.

Hake's gain factor for the same set of questions are defined as:

$$h = (\text{posttest-pretest}) / (1-\text{pretest}).$$

Hake's factor gain in control group (group A):

First question $(0.35-0.21) / (1.00-0.21) = 0.1772$,
 Second question $(0.33-0.12) / (1.00-0.12) = 0.2386$,
 Third question $(0.17-0.60) / (1.00-0.60) = 0.1170$,
 Fourth question $(0.13-0.10) / (1.00-0.10) = 0.0333$,
 Fifth question $(0.24-0.13) / (1.00-0.13) = 0.1264$,

Hake's factor gain in experimental group (group B):

First question $(0.30-0.20) / (1.00-0.20) = 0.1250$,
 Second question $(0.27-0.09) / (1.00-0.09) = 0.1970$,
 Third question $(0.17-0.07) / (1.00-0.07) = 0.1075$,
 Fourth question $(0.13-0.09) / (1.00-0.09) = 0.0430$,
 Fifth question $(0.30-0.24) / (1.00-0.24) = 0.0789$.

The Hake's gain factor is said to be high-gain if $h \geq 0.7$, medium-gain courses ($0.7 > h \geq 0.3$), and low-gain courses ($h < 0.3$). Hake's factor was low in both groups to be considered here.

The data were taken in 2013 by Diego Fernando Becerra Rodríguez, student of Master of Science in Physics Education of Research Center of Applied Science and High Technology of the National Polytechnic Institute. Legaria Unit of Mexico City. The students were the College of St. Elizabeth of Hungary in Bogota, Colombia. We hope that the measurements are reliable enough, although the author must recognize that much work remains to be done in this area, collecting further information, to improve the reliability of the results shown here.

9. Conclusions

Of the cast results of statistical analysis of Student's t , one can conclude that learning physics supported ICT has great benefits, and that students learn significantly. Traditional teaching also gives very good results, but due to components on the construction of knowledge by students. It can be said that the methodology based on the support of ICT and PODS cycle perfectible latter, and have better results than in the past method. However, the use of ICT and the PODS cycle requires more time and preparation by the teacher and students than traditional education.

Therefore, it is recommended to apply the latest on the first, whenever this is possible and the teacher has enough time to employ our methodology.

Although the author knows that some tests of this methodology with one control group and an experimental group, is not enough to ensure that the methodology described is better than traditional teaching. We have

the faith and conviction that the new methodology with PODS cycle and the use of ICT is better than traditional teaching techniques.

There is still much work to do, to say such a thing. But we trust that these results are a good indication that we worked well, and that we must continue to do so in the same way in the future.

Acknowledgments

The author wishes to thank the COFAA of the National Polytechnic Institute (IPN) of Mexico in Mexico City, for the financial support that it provided in the course of this work. Also, want to thank the support received through the project of the Ministry of Research and Graduate SIP-20144659 of IPN-Mexico and the project SIP-20141373.

References

- Cabero-Almenara, J. (1998). Las aportaciones de las nuevas tecnologías a las instituciones de formación continuas: reflexiones para comenzar el debate. *V Congreso Interuniversitario de Organización de Instituciones Educativas: las organizaciones ante los retos del siglo XXI*, 1143-1149.
- Castiblanco, O. L. & Vizcaín, D. F. (2008). El uso de las TICs en la enseñanza de la Física. *Revista Ingenio Libre*, **12**, 20-26.
- Chen, S. (2010). The view of scientific inquiry conveyed by simulation-based virtual laboratories. *Magazine Computers & Education*, **55**, 1123-1130.
- Esquembre, F. *Easy Java Simulations*. Available at website <http://www.um.es/fem/EjsWiki/Main/WhatIsEJS>, consulted 10-30-2012 at 1:40 pm.
- Hake, R. (1998). Interactive-engagement versus traditional methods: A six-thousand-student survey of mechanics test data for introductory physics courses. *American Journal of Physics*, **66**, 64-74.
- Llorente, M. (2010). *Formación semipresencial en la red Blending Learning*, ed. MAD SL.
- Margalef, L. & Álvarez, J. (2005). La formación del profesorado universitario para la innovación en el marco de la integración del espacio europeo de educación superior. *Revista de Educación*, **337**, 51-70.
- McDermott, L. C., & Shaffer, P. S. (2001). *Tutoriales para Física Introductoria*. 1st ed. Pearson.
- myPhysicsLab.com. Available at website <http://www.myphysicslab.com>, consulted 10-30-2012 at 1:20 pm.
- Orozco, J. (2011). *El teléfono celular como recurso didáctico en el Álgebra Vectorial para la Física en el nivel Medio Superior*. 1st ed. Instituto Politécnico Nacional Centro de Investigación en Ciencia Aplicada y Tecnología Avanzada. Master of Science Thesis.
- Sánchez, J. (2003). Integración curricular de TICs. Concepto y Modelos. *Revista Enfoques Educativos*, **5**, 51-65.
- Silveira, L. & Moreira, M. (1996). Validación de un test para verificar si el alumno posee concepciones científicas sobre calor, temperatura y energía interna. *Enseñanza de las ciencias*, *Barcelona*, **14**, 75-86.
- Sokoloff, D. & Thornton, R. (2004). *Interactive Lecture Demonstration Active Learning in Introductory Physics*. ed. John Wiley & Sons Inc.
- Sokoloff, D., et al. (2006). *Active Learning in Optics and Photonics*. 1th ed. UNESCO.
- Sears, F. & Zemansky, M. (2004). *Física Universitaria Volumen 2*. 11th ed. Pearson Educación.
- Serway, R. & Jewett, J. (2000). *Física para ciencias e ingeniería*. 7th ed. Cengage Learning.
- Velázquez, L. (2012). *Aprendizaje Activo para las Leyes de Newton a nivel Medio Superior*, 1st ed. Instituto Politécnico Nacional Centro de Investigación en Ciencia Aplicada y Tecnología Avanzada. Master of Science Thesis.
- Yeo, S. & Zadnik, M. (2001). Introductory Thermal Concept Evaluation: Assessing Students' Understanding. *The Physics Teacher*, **39**, 496-504.
- Lee projects. Available at website <http://johnnylee.net/projects/wii/>, consulted 10-30-2012 at 1:00 pm.

Affiliation and address information

Rubén Sánchez Sánchez

Centro de Investigación en Ciencia Aplicada y Tecnología Avanzada del Instituto Politécnico Nacional.

Legaria Unit.

Graduate in Physics Education.

Carriageway Legaria #694.

Cologne: Irrigación.

Delegation: Miguel Hidalgo.

Zip Code: 11500. Mexico City, Mexico.

Office phone: (52)(55)572960067737

e-mail: rsanchezs@ipn.mx

The Photoelectric Effect and Study of the Diffraction of Light: Two New Experiments in UNILabs Virtual and Remote Laboratories Network.

Juan Pedro Sánchez, Jacobo Sáenz, Luis de la Torre, Carmen Carreras, Manuel Yuste, Rubén Heradio, Sebastián Dormido.

UNED, Madrid, Spain.

Abstract

This work describes two experiments: “study of the diffraction of light: Fraunhofer approximation” and “the photoelectric effect”. Both of them count with a virtual, simulated, version of the experiment as well as with a real one which can be operated remotely. The two previous virtual and remote labs (built using Easy Java(script) Simulations) are integrated in UNILabs, a network of online interactive laboratories based on the free Learning Management System Moodle. In this web environment, students can find not only the virtual and remote labs but also manuals with related theory, the user interface description for each application, and so on.

Keywords

Virtual labs, remote labs, simulations, optics.

1. Introduction

Traditional face-to-face lectures and experimental laboratory sessions can be complemented with new online experimental frameworks. While there already are lots of Internet resources (many of them accessible for free) to fulfil many theoretical aspects on education, engineering and scientific studies also need more specific Internet based tools to cover the practical part of their teaching. Examples of this can be found in works [Chang, G. W., Yeh, Z.M., Chang, H. M. and Pan, S. Y. (2005), de la Torre L., Sánchez J., Dormido S., Sánchez J. P., Yuste M., Carreras C. (2011) and Wannous, M. and Nakano, H. (2010)].

Tools such as Learning Management Systems (LMSs) and web-based labs have become widespread in distance education in the last decade. LMSs support the administration, documentation, tracking, and reporting of training programs, classroom and online events [Ellis, R. K. (2009)]. Web-based labs make possible to illustrate scientific phenomena that require costly or difficult-to-assemble equipment, and should ideally consist of two different and complementary parts:

- *Virtual Labs* provide computer based simulations which offer similar views and ways of work to their traditional counterparts. Nowadays, simulations have evolved into interactive graphical user interfaces where students can manipulate the experiment parameters and explore its evolution.
- *Remote Labs* use real plants and physical devices which are teleoperated in real time. Remote experimentation through the Internet has been available for more than a decade and its interest has never diminished over the years.

Even though constructivist web learning environments and Virtual/Remote Labs (VRLs) already exist, there is still a lack of convergence and interoperability between both tools [Gravier, C., Fayolle, J., Bayard, B., Ates, M. and Lardon, J. (2008), Guimaraes, E. G., Cardozo, E., Moraes, D. H. and Coelho, P. R. (2010) and Salzmann, C. and Gillet, D. (2007)]. This work applies a solution that solves this gap [de la Torre, L., Sanchez, J. P., Heradio, R., Carreras, C., Yuste, M., Sanchez, J. and Dormido, S. (2012) and Heradio, R., de la Torre, L., Sanchez, J., Dormido, S. and Vargas, H. (2011)], to two newly developed virtual and remote laboratories on Physics (the photoelectric effect and the study of diffraction of light).

In terms of hardware, each remote practice uses a different set of tools and devices. In terms of software, they are both built using the same computer program (Easy Java(script) Simulations or EjsS). Virtual laboratories are also developed using this same program. Since all the applications (either for virtual or remote labs) are based on the same technology, their integration into a LMS (Moodle, in this case) is simplified. Moodle is a widespread used LMS (more than 60 million registered users, according to its official webpage) that supports constructivist learning, offering its users communication and interaction facilities.

EjsS [Christian, W. and Esquembre, F. (2007) and Christian, W., Esquembre, F. and Barbato, L (2011)] is a tool designed for the creation of discrete computer simulations. During the last few years, EjsS has grown for helping to create web-accessible labs in control engineering education. With this objective in mind, recent releases of EjsS support connections with external applications, such as LabView and Matlab/Simulink. Hence, EjsS is useful not only to create virtual labs, but also the graphical user interfaces (GUIs) of their remote counterparts.

2. UNILabs: the network of virtual and remote laboratories

UNILabs (<http://unilabs.dia.uned.es>) is a University Network of Interactive Labs, born on September 2013. One year later, it already offers ten courses from eight different universities with around 20 virtual and/or remote laboratories and covering topics such as physics, automatic control or mathematics. The secret of the fast growing of UNILabs is its web 2.0 features, extended to the addition of simulations, virtual and/or remote laboratories: in UNILabs, each teacher has editing rights over their own courses and therefore, any of them can add, in an easy and an autonomous way, the experimentation resources they need for their courses and subjects. Figure 1 shows UNILabs homepage.

UNILabs web portal is based on Moodle, a LMS that provides a social context for students collaboration. Moodle enriches virtual and remote labs by facilitating and promoting the tools for students to discuss the experiments between them and teachers, exchange their lab reports, etc. In addition, Moodle helps to distribute all the convenient resources for a complete online experiment. For instance, attached to the web-lab, a course in Moodle may include a description of the phenomena under study, videos, the task protocol that students must follow, a questionnaire, etc. Finally, Moodle allows creating open courses that are accessible and available for anyone, making our labs, both the virtual and remote ones, usable for any person who might be interested: for example, students who want to learn more on their own. While the VRLs on Physics are only accessible for students of those universities that participate in the UNILabs project, it is planned to make them freely accessible for anyone in a new open course focused on Physics topics.

More information about the UNILabs portal and the tools it is based on can be found in video format at our youtube channel: <http://www.youtube.com/user/UNEDLabs>.

3. New Physics experiments

The new Physics real and remote experiments in UNILabs count with a virtual (simulated) counterpart so students can familiarize with both the phenomena under study and the user interface before they access the actual, remote lab. The virtual labs offer a way of obtaining theoretical results students can use for contrasting and comparing with the real ones obtained from the remote experiments.

The screenshot shows the UNILabs homepage with a blue header. The main content area is divided into several sections. At the top, there's a navigation bar with 'UNILabs' and 'English (en)'. Below that, a central section titled 'Our interactive labs (1)' features a large image of a simulation interface. To the left, a 'MAIN MENU' sidebar lists guides for accessing lab applications and remote labs. Below the central image, there are three columns of text: 'EXPERIMENT!' (Perform your experimentation activities with our virtual and/or remote labs), 'ENHANCE YOUR EXPERIENCE!' (Store the data collected with the labs in the cloud, participate in collaborative sessions and much more), and 'STAY IN TOUCH!' (Be part of a teaching/learning community formed by several universities). At the bottom, there's a section titled 'Available courses' with a featured course 'Open Course with Free Access Labs on Control' by Luis de la Torre.

Figure 1. UNILabs homepage

The photoelectric effect

In this practice, fundamentals of the photoelectric effect are studied and an experimental determination of Planck's constant, h , is carried out. A commercial experimental setup from Leybold Didactic was used to allow students performing this experiment in a remote way. This setup consists of an optical bench with a mercury lamp, a collimator lens, a disc with a collection of interferential filters of different wavelengths and a photoelectric cell. A power supply for the mercury lamp, an amplifier circuit used to take measurements, a second small power supply for this amplifier circuit and a voltmeter are also part of this commercial setup.

The tweaks made over this commercial setup in order to support a remote use were: 1) replacing the original disc with the collection of filters by a larger and motorized disc (which allows a larger number of filters) thanks to the use of a stepper motor, 2) connecting an Arduino board for data acquisition (to complement the original voltmeter) and controlling the motor, 3) placing a webcam to provide visual feedback, and 4) programming the control of the instrumentation and the GUI (created using EjsS). The experimental procedure consists in registering the charge voltage in the capacitor (saturation value) when radiations of different wavelength act over the photoelectric cell. The selection of the different wavelengths is achieved by means of the corresponding filters. An analysis of the data registered in this experiment allows determining Planck's constant. Figure 2 depicts the assembly used for this experiment while Figure 3 shows a couple of pictures.

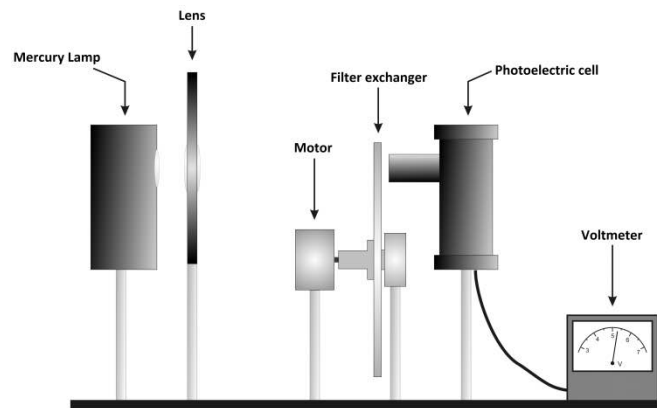

Figure 2. Diagram of the photoelectric effect experiment.

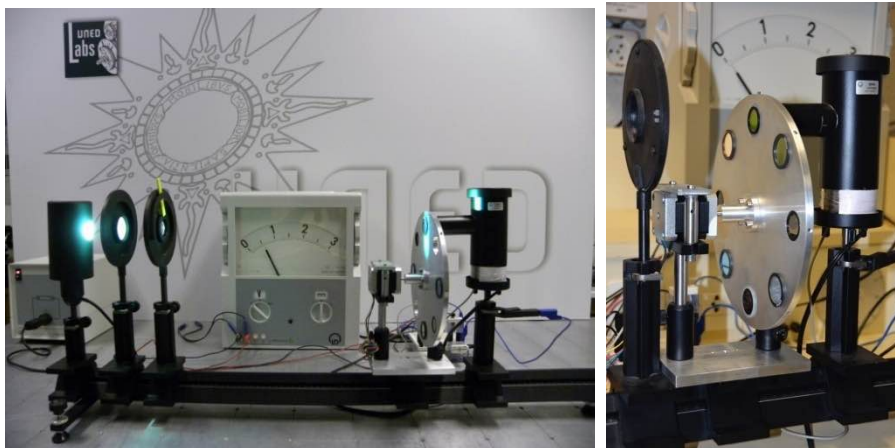

Figure 3. Pictures of the didactical setup for the photoelectric effect experiment.

The VRL applications for this experiment allow selecting the wavelength of the light that gets to the photoelectric cell, taking measures of the registered stopping voltages (see left image in Figure 4) and plotting both values (voltages against wavelengths) in order to make a linear regression and obtain h with good precision (see right image in Figure 4).

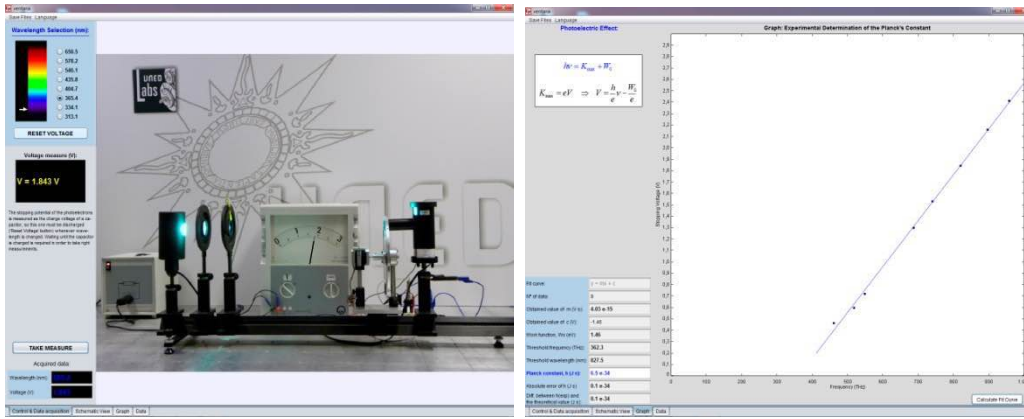

Figure 4. VRL application for the photoelectric effect experiment.

Study of the diffraction of light

The aim of the experiment is to study the diffraction patterns produced by different diffracting objects. First, students must observe the diffraction patterns projected over the translucent screen, thanks to the use of a webcam. From the visual analysis of these figures, they can check the validity of the light diffraction theory and, by determining the position of the intensity minima and maxima, estimate the size of those objects that produce such figures. As a second task, students obtain the intensity outline of a diffraction pattern acquiring intensity measurements with the photodiode; the later processing of such measurements allows the total characterization of the figure, checking the validity of the theory and determining the object size with higher precision.

For this lab, an experimental setup has been especially designed and built so that it can be used in a remote way. The experimental setup consists of a He-Ne laser, a collection of diffracting objects with easy geometries, a translucent screen with a coupled webcam and a photodiode connected to a digital multimeter. In order to allow the remote control of the experiment process, two motorized linear positioners are used: one (of 10 cm) in horizontal position and another one (of 25 cm) in vertical position. This X-Z positioning system allows choosing one particular diffracting object among the collection and calibrating its position. The translucent screen with the coupled webcam can also be moved thanks to a linear positioner of 2 meters, which allows adjusting the distance of observation (Y axis). Over the slide with the different diffracting objects, a mirror is also mounted. The mirror forms a 45° angle with the incident laser (Y axis) so that the ray can be diverted to a perpendicular direction (X axis) in order to project the figure of a different diffracting object over the photodiode, also mounted over a horizontal motorized positioner with micrometric precision. By placing or not the mirror in the incident ray trajectory, students can change between the measurement of intensities with the photodiode and the mere visual observation of the rest of figures. Figure 5 depicts the assembly used for this experiment while Figure 6 shows a picture of it.

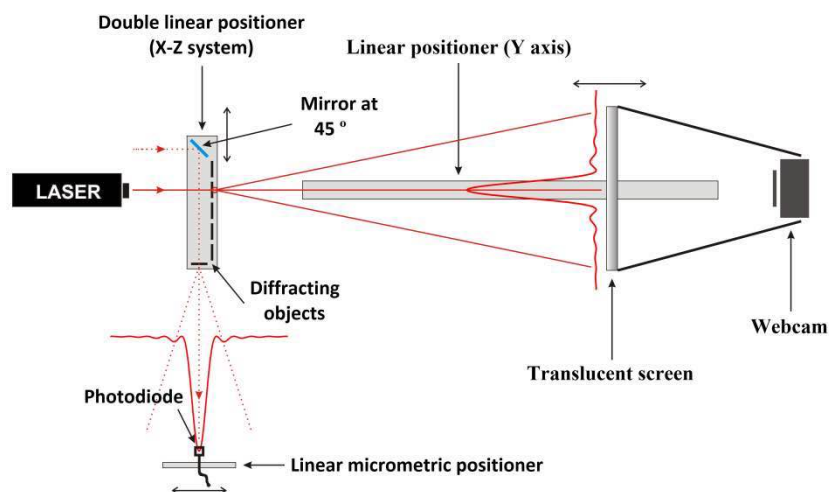

Figure 5. Diagram of the diffraction of light experiment.

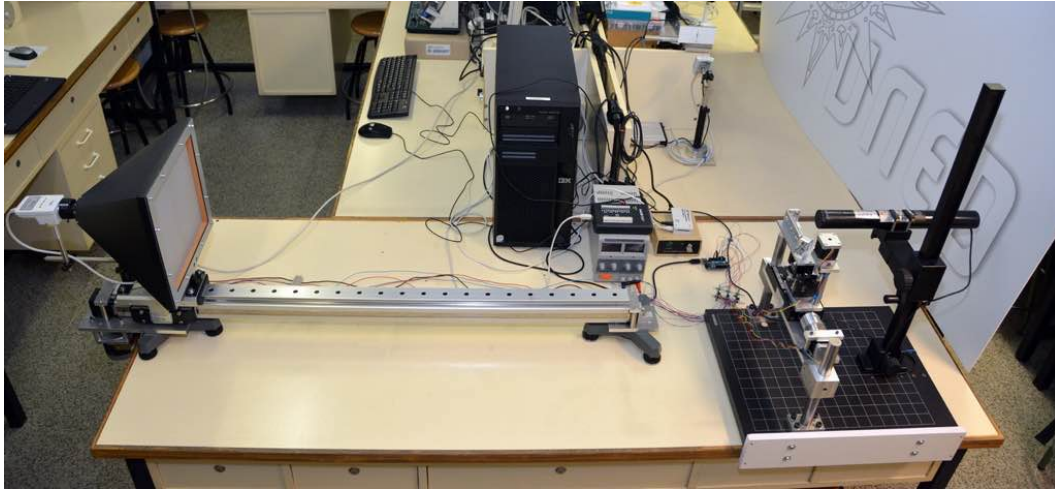

Figure 6. Picture of the didactical setup for the diffraction of light experiment.

The virtual laboratory application interface allows determining the size of the diffracting object using both a qualitative method (left image in Figure 7) and a quantitative method (right image in Figure 7). The remote laboratory application interface is very similar in terms of graphical design and usability (an example is given in Figure 8) and it also offers the previous two methods for determining the size of the diffracting objects. However, due to physical limitations, while in the virtual lab the second (quantitative) method can be used with all the objects, in the remote lab it can be used just with one.

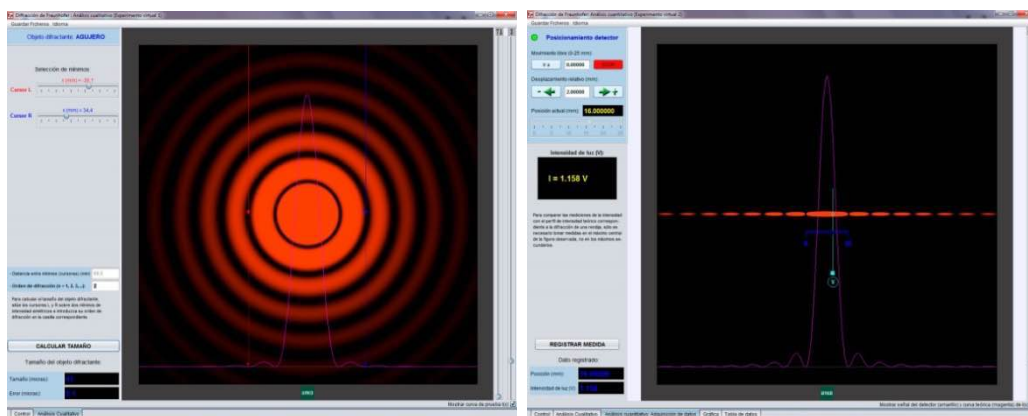

Figure 7. Virtual lab application for the diffraction of light experiment.

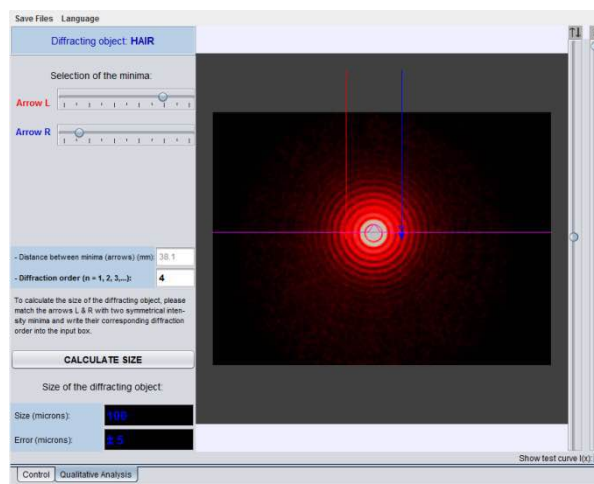

Figure 8. Remote lab application for the diffraction of light experiment.

4. Conclusion

The development of new virtual and remote laboratories is important to increase the subjects covered by the University Network of Interactive Laboratories web portal. Two new virtual and remote laboratories to carry out physics practices in the photoelectric effect and the diffraction of light are now available in UNILabs. At the moment of writing these lines, the virtual and the remote labs are only accessible for our students but we plan on making them freely accessible for anyone in a new open course focused on Physics topics.

With respect to the architecture used to develop the two new virtual labs, EjsS was selected due to its easy and power of use. Regarding the remote labs, their GUI were also built using EjsS while low-cost hardware boards (Arduino) were used for data acquisition, controlling motors and turning on and off the light sources.

References

- Chang, G. W., Yeh, Z.M., Chang, H. M. and Pan, S. Y. (2005). Teaching photonics laboratory using remote-control web technologies, *IEEE Transactions on Education*, **48**, 642–651.
- Christian, W. and Esquembre, F. (2007). Modeling physics with easy java simulations, *The Physics Teacher*, **45**, 475–480.
- Christian, W., Esquembre, F. and Barbato, L (2011). Open source physics, *Science*, **334**, 1077–1078.
- Ellis, R. K. (2009). Field guide to learning management systems, *ASTD Learning Circuits*, Tech. Rep.
- Gravier, C., Fayolle, J., Bayard, B., Ates, M. and Lardon, J. (2008). State of the art about remote laboratories paradigms - foundations of ongoing mutations, *International Journal of Online Engineering*, **4**, 2008.
- Guimaraes, E. G., Cardozo, E., Moraes, D. H. and Coelho, P. R. (2010). Design and implementation issues for modern remote laboratories, *IEEE Transactions on Learning Technologies*, **4**, 149–161.
- Heradio, R., de la Torre, L., Sanchez, J., Dormido, S. and Vargas, H. (2011). An architecture for virtual and remote laboratories to support distance learning, *Proceedings of the Research in Engineering Education Symposium*, 579-587.
- Salzmann, C. and Gillet, D. (2007). Challenges in remote laboratory sustainability, in *International Conference on Engineering Education*, Coimbra, Portugal, 2007.
- de la Torre, L., Sanchez, J. P., Heradio, R., Carreras, C., Yuste, M., Sanchez, J. and Dormido, S. (2012). “Unedlabs - an example of ejs labs integration into moodle,” *Proceedings of the World Conference on Physics Education*, 537-546.
- de la Torre L., Sánchez J., Dormido S., Sánchez J. P., Yuste M., Carreras C. (2011). Two web-based laboratories of the FisL@bs network: Hooke’s and Snell’s laws, *European Journal of Physics*, **32**, 571-584.
- Wannous, M. and Nakano, H. (2010). Nvlab, a networking virtual web-based laboratory that implements virtualization and virtual network computing tech.” *IEEE Transactions on Learning Technologies*, **3**, 129–138.

Affiliation and address information

Juan Pedro Sánchez, Carmen Carreras, Sebastián Dormido
 Department of Material Physics
 UNED
 Paseo Senda del Rey, s/n
 28040 Madrid, Spain
 e-mail: jpsanchez,ccarreras,myuste@ccia.uned.es

Jacobo Sáenz, Luis de la Torre, Sebastián Dormido, Rubén Heradio
 Department of Computer Science and Automatic Control
 UNED
 C/ Juan del Rosal, 16
 28040 Madrid, Spain
 e-mail: jsaenz@bec.uned.es; ldelatorre,sdormido@dia.uned.es; rheradio@issi.uned.es

Training and Assessment of Experimental Competencies from a Distance: Optical Spectrometry via the Internet

Lars-Jochen Thoms, Raimund Girwidz

Ludwig-Maximilians-Universität, Munich, Germany

Abstract

Assessment of experimental competencies is not yet well established. We just began an empirical pilot study, too. This study aims to examine if secondary school students may successfully use a predefined remote lab activity to introduce themselves to atomic physics. The analysis of spectra is a fundamental component for the understanding of wave optics and color perception. Hence, every student should have the opportunity to conduct own optical emission experiments. Since spectrometers are expensive and an accurate calibration is necessary to achieve energy distribution spectra of high quality, we developed a remotely controlled laboratory. We evaluated the experimental set-up and the accompanying worksheet with groups of two to four students in a laboratory condition. Additionally, the emerged learning material was brought to school and tested as a homework activity with 9th-graders replacing the regular introduction to atomic physics. The results show that the experiment presented here can be used by ninth grade students and is useful in connection with the created material for the self-regulated introduction to atomic physics in the context of homework.

Keywords

Experiment, Lab Work, Homework, Atomic Physics, Emission Spectra, Remotely Controlled Laboratory, Remote Lab, Experimental Competencies, Assessment

1. Introduction

Since Bohr discovered the relationship between optical spectra and the structure of atoms, spectrometry has been an important method in physics and chemistry. Furthermore, the analysis of spectra is a fundamental component for the understanding of wave optics and color perception. Every student should have the opportunity to conduct his or her own optical emission experiments. Since spectrometers are expensive and an accurate calibration is necessary to achieve energy distribution spectra of high quality, we developed a remotely controlled laboratory.

2. Experimenting in school

Experimenting is an essential part of physics and physics education (Duit and Tesch, 2010; Tesch and Duit, 2004; Hofstein and Lunetta, 1982). This applies to every kind of demonstration experiments or student activity. Students in German upper secondary education recognize the crucial role of experiments, even though demonstration experiments dominate and student hands-on activities are rarely carried out (Baumert and Köller, 2000). Demonstration experiments are often embedded in a teacher dominated, questioning-developing approach (Seidel et al., 2002; cf., Duit and Tesch). Student experiments are often constrained by precise instructions. However, instructional approaches that link theory and experiments and engage students actively should lead to a deeper understanding (Baumert and Köller). The way of integrating experiments into the lesson plan determines the learning success (Tesch and Duit; Harlen, 1999). For the development of the learner's performance, not only the experimental time on task is critical, but also the total processing time, including preparation and review (Tesch and Duit). Tesch & Duit assume that the large amount of time needed to carry out student experiments reduces the time for preparation and review in the classroom. They consider this as a possible reason, why student experiments do not generally lead to better performances (Hofstein and Lunetta, 2004).

3. Self-regulated learning

The idea of self-regulated learning takes cognitive and emotional perspectives of learning into account (e.g., Butler and Winne, 1995; Schraw, 1998). One intention amongst others is to foster interest (Krapp, 1999, 2005), self-determination (Deci and Ryan, 1993), or self-efficacy (Bandura, 1997). Since self-regulation is necessary for effective intentional learning (Bereiter and Scardamalia, 1989), learners should be able to self-regulate their learning process (Bransford et al, 2000). A suitable approach to foster self-regulated learning in physics education is discovery learning. On the one hand, discovery learning can lead to a deeper understanding. On the other hand, learners may encounter difficulties during discovery learning (De Jong and Van Joling, 1998). In addition, students' ability to engage in self-regulated learning depends on domain specific prior knowledge (Brown & DeLoache, 1978), what in fact stands in contrast to the initial idea of discovery learning. Research on problem-based learning showed that learners with lower prior knowledge use less efficient problem-solving strategies less effective (Alexander & Judy, 1988). This finding is transferrable to discovery learning (Lavoie & Good, 1988; Schauble et al, 1991; Hmelo et al, 2000). This leads to the question, which domain specific knowledge should be offered to students in a computer-based interactive learning environment inducing discovery learning? Thereby, it must be considered that the knowledge of the meaning of variables per se is not productive, it is very important that students understand how variables are interrelated with each other (Lazonder et al, 2009).

4. Experimental competencies

Many national science education standards define competencies in science and engineering that all students should be able to demonstrate at subsequent stages in their K-12 learning experience (e.g., National Research Council, 2013).

“Competencies are the cognitive abilities and skills available or learnable for individuals to solve specific problems, as well as the associated motivational, volitional and social willingness and abilities to utilize the problem solutions successfully and responsibly in variable situations.” Weinert (2001, 27f, transl.)

According to this definition, competencies are domain-specific, learnable, underlying, thus latent variables, which are not directly observable. They are functionally defined and manifest in problem-solving solutions.

5. Assessment of experimental competencies

Tools are needed which assess knowledge about scientific theories and findings, and skills of knowledge acquisition as well. Established instruments for assessment of experimental competencies are hands-on experiments (assessment by direct observation and by analyzing student's workbooks), computer simulations, and paper-and-pencil tests.

According to Shavelson, Ruiz-Promo and Weily (1999), the assessment results from hands-on experiments and computer simulations are directly exchangeable. Since hands-on experiments are not suitable for large-scale assessment, process-oriented experimental competencies may be assessed in virtual labs.

Considering the debate on minimally guided teaching techniques (e.g., Kirschner, Sweller and Clark, 2006; Schmidt, Loyens, van Gog and Paas, 2007; Hmelo-Silver, Duncan and Chinn, 2007; Kuhn, 2007; Sweller, Kirschner and Clark, 2007), assessment tools on experimental competencies including process-oriented inquiry techniques should be familiar to students to prevent cognitive overload while assessing competencies. Furthermore, the format of an assessment tool for a particular learning environment should be similar to the format of the learning environment itself (cf., Brünken, Steinbacher, Schnotz, and Leutner, 2001). Therefore, teachers should introduce these assessment tools in class as instructional tools.

6. Experimenting from a distance

If expensive, complex, or challenging experimental set-ups are not available or practicable in school, remotely controlled laboratories (cf., Gröber, Vetter, Eckert and Jodl, 2007) can offer new, additional possibilities, which enable experimental experience, develop experimental competencies, and furthermore assist discovery learning. For many reasons, experiments should be feasible in distance learning.

Remotely controlled laboratories are a useful supplement to in-class experiments, interactive screen experiments (cf., Kirstein and Nordmeier, 2007), animations and simulations, if ...

- the experimental set-up is difficult, lengthy or expensive,
- the processing includes dangerous tasks,
- the number of variable parameters is large, so that the experiment could not be implemented as an interactive screen experiment, or

- the processing needs distinct scaffolds, which is a special interest in educational research.

A homework-based activity in a remote lab may deliver a new approach to procedural learning. Furthermore, lab activity as homework could foster problem-based, discovery, and inquiry-based learning and support collaborative and cooperative learning as well.

Remotely controlled laboratories enable students to conduct demonstration experiments in a self-responsible, active and at the same time harmless fashion. In this situation, students can watch their peers during the implementation and learn from their successes and mistakes. Another advantage of remotely controlled laboratories is the ability to record actual data in real time, afflicted by measuring errors. The biggest benefit for the educational research is that fully detailed actions from active users are immediately registered and could be evaluated. All this happens in the absence of repercussion, which means that the user is not disturbed in any way.

7. Four levels of inquiry

Banchi and Bell (2008) proclaim four levels of inquiry in activities with rising opening and withdrawal of predefined structure, confirmation inquiry, structured inquiry, guided inquiry and open inquiry.

- On the first level—*confirmation inquiry*—students confirm a principle through an activity when the results are known in advance.
- On the second level—*structured inquiry*—students investigate a teacher-presented question through a prescribed procedure.
- On the third level—*guided inquiry*—students investigate a teacher-presented question using student designed or student selected procedures.
- On the fourth level—*open inquiry*—students investigate questions that are student formulated through student designed or student selected procedures.

Based on this classification, we developed a remotely controlled laboratory with predefined set-ups selectable according to the class. This reduces the complexity of the lab activity for students. Students can carry out real experiments online. E.g., they can choose from different light bulbs and analyze them with a spectrometer. All user activities are logged by the system without disturbing the students.

8. Development of a remote-lab experiment on optical spectrometry

For the presented experiment on optical spectrometry via the Internet, three aspects were at the foreground of the technical implementation:

First, the experiment should be usable across many grade levels and in various settings. This affects on the one hand the number of adjustable parameters of the experimental set-up and thus its complexity and on the other hand supports the decision to offer the experiment as isolated gauge and not necessarily to embed it in a learning environment.

Secondly, the operation of the experiment should also be possible via mobile devices such as smartphones and tablets. Furthermore, the measurement values should be displayed in real time also in mobile networks. This had implications for the programming of the operating software and the type of data transmission.

Last, no software installation or setting change should be necessary and a data transmission ensured even with restrictive firewalls. In addition, due to the use of a WebSocket service the experiment does not require its own static IP address.

Experimental set-up

The developed experiment on optical spectrometry allows the assessment of customary lamps with E 27 lamp sockets. For that purpose, the irradiation at a certain position is collected with an optical fiber and analyzed with a USB compact spectrometer. The spectrometer used projects the received light through a 25 μm entrance slit onto a linear silicon CCD array with 651 active pixels offering approximately 2.0 nm optical resolution full width at half maximum. Radiation within a wavelength range of 350-1000 nm is recorded with 12-bit A/D resolution. With this, “intensities” are measured within a range of 0-4096 arbitrary units.

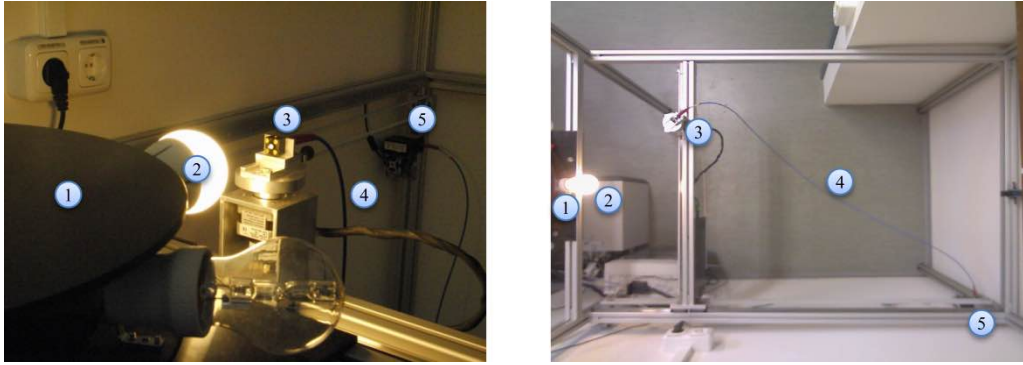

Figure 1. Experimental set-up of the spectrometer remote lab implementation (a) in detail and (b) from above: (1) carousel, (2) light source, (3) cosine-corrected probe, (4) optical fiber, (5) spectrometer.

The detector's field of view

Some experimental objectives take into account the radiant characteristics of different light sources. In order to analyze the radiation field around a particular light source under constant experimental conditions, the spectral irradiance on a probe is measured.

The irradiance is the total power of electromagnetic radiation per unit area incident on a surface, such as the fiber's cross-section at its tip. Nevertheless, with a bare fiber it is not possible to measure the true irradiance because the coupling of light into the fiber is highly dependent on the angle of incidence. Instead, the irradiance should be proportional to the cosine of the angle of incidence (cf. Eppeldauer, 1996). Furthermore, a probe with a 180-degree field of view is needed. The spectrometers' manufacturer provides a so-called cosine corrector: a window made from opaline glass mountable on the tip of the optical fiber creating a dependency on the angle of incidence that is nearly proportional to the cosine (cf. Eppeldauer *et al.*, 1998).

Spectral sensitivity and calibration of a radiometric detector

Unfortunately, the following aspect often is not sufficiently discussed. “*Knowledge of the spectral irradiance responsivity of a meter is critical for high accuracy measurements of sources with different spectral power distributions.*” (Larason *et al.*, 2001, 1)

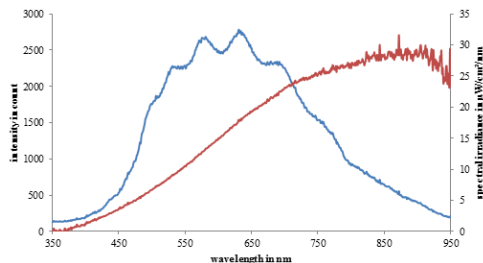

Figure 2. Measured spectrum of a tungsten halogen lamp (blue) and spectral irradiance (red).

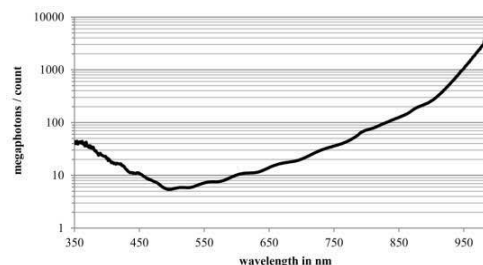

Figure 3. Spectral sensitivity of the detector system used for the experimental set-up.

Figure 2 shows the measured spectrum of a customary tungsten halogen lamp (blue curve). For learning purposes, this graph requires special considerations. Students may interpret this spectrum as blackbody radiation, on the one hand due to the form of the curve, and on the other hand based on their knowledge that thermal radiators like tungsten lamps may be regarded as blackbody radiators. Actually, a tungsten lamp radiates only a small part (about 4%) of its radiation in the visual part of the electromagnetic spectrum. The important point to keep in mind is that the spectral sensitivity of the detector system is extremely dependent on the irradiated wavelength. Figure 3 shows the measured spectral sensitivity of the detector system used for the experimental set-up with a logarithmic scaling. Attention should be paid to the fact that there is a factor of 1000 in the spectral sensitivity between 500 nm and 1000 nm. Without accurate calibration, neither two measured “intensities” at different wavelengths may be compared nor can any statements be made about the spectral power distribution of the radiation examined. For the calibration of the radiometric system used, the German distributor of the spectrometers' manufacturer kindly provided us with a NIST traceable radiometric calibration standard. In this case, it is a calibrated tungsten halogen light source with a well-

known spectral power distribution. This calibration standard provides absolute spectral irradiance in $\mu\text{W}/\text{cm}^2/\text{nm}$ at the fiber port. The spectrometer can be calibrated specifically for a bare fiber or a fiber with attached cosine corrector.

Experimental processing

Several parameters of the experimental set-up may be changed by the user. For example, the acquisition parameters for the spectrometer may be set, like the integration time, the boxcar width (averaging over neighboring pixels), or the samples to average (averaging over two or more subsequent spectra). Furthermore, users can choose from six standard light bulbs mounted on a carousel like tungsten incandescent light bulbs, halogen incandescent lamps, cool white and soft white compact fluorescent lamps, light-emitting diode lamps or special bulbs (see figure 1). The cosine-corrected probe may be moved and positioned in front of the bulb in a field of 115×65 square centimeters. The probe may be rotated too. These many different parameters provide many opportunities and guarantee an authentic experimental experience.

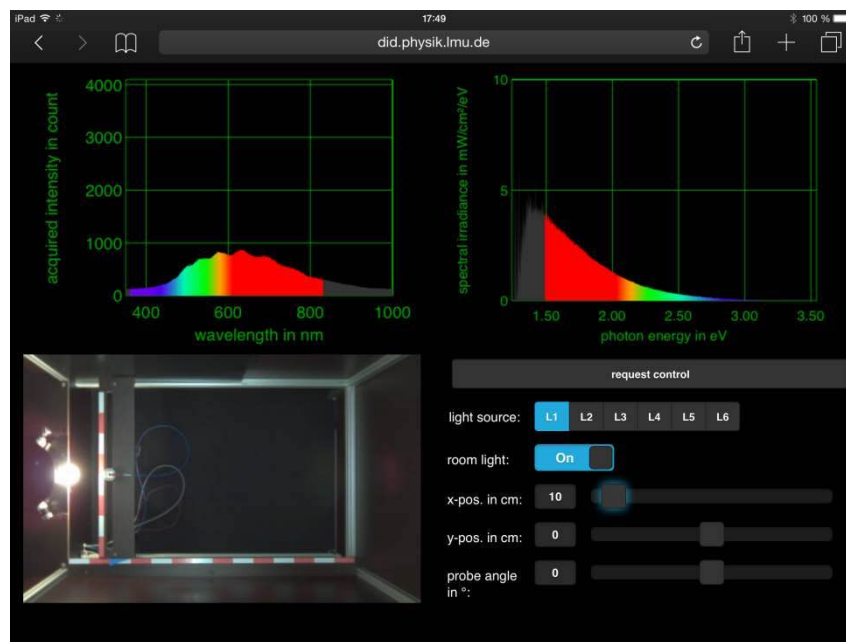

Figure 4. One exemplary implementation of the adjustable graphical user interface.

Experimental aims and objectives

With the experimental set-up described above, many different objectives can be followed by students. They may compare spectra from different lamps and thus rate the usability of the light sources for a certain purpose. Students may assess color temperature and color fault. They may compare the radiated light with the color sensitivity of the human eye. Students may distinguish between physical and physiological quantities. They can analyze the energy efficiency of customary lamps.

The free positioning of the probe allows further experiments like analyzing the decrease of the spectral irradiance in proportion to the square of the distance from the source or the spatial spectral radiant emittance. With compact fluorescent lamps, differences can be noticed between the light coming from the gas discharge and the light coming from the fluorescent layer.

Expert learners may examine, distinguish, classify, and rate the directional characteristics of radiation from different light sources. This is very interesting with light emitting diodes, which often radiate highly anisotropic.

9. Pilot study

The learning material for the introduction to atomic physics was created as an initial pilot study with ninth-grade students in a secondary school in Germany. While continuous and monochromatic spectra should already be familiar from prior teaching discrete spectra is a new concept. The appearing emission lines are identified with electron transitions in the electron shell and thus introduce the topic of atomic physics. The course material is designed for self-regulated study within the context of homework.

The following tasks should be tackled during the study of the work material:

Students are expected to...

- describe spectra of various light sources,
- name categories of spectra,
- investigate different light sources and assign them to these categories,
- measure the spectral irradiance during exposure to a compact fluorescent lamp,
- carry out quantitative comparisons of two spectral lines as well as
- perform energy conversions.

Research instruments

The work material itself initially is the instrument and object of this first exploratory study. The difficulty of the individual subtasks is of particular interest here. In addition, the actions of the students were recorded during the experiment.

Sample

A pilot study on the work material was conducted with four classes in secondary schools in Germany. Three classes from grades eight, ten, and eleven worked on the material under laboratory conditions, for a limited time, and in groups of two to four students. A ninth grade class was introduced to the material in school according to the intended purpose and had to work on it within a week as part of their homework.

Evaluation

In addition to the content evaluation of the solutions, the answers to problems with an open response format were subjected to a qualitative content analysis according to Mayring (2010). The frequencies of certain inductively determined response categories were analyzed.

For simple allocation tasks, the response frequencies were measured.

10. Results

This first exploratory study aims at reviewing the suitability of the developed experimental set-up, as well as reviewing the created course material for a self-regulated introduction to atomic physics in the context of homework at ninth grade level.

Verbal description of figurative displayed spectra

When verbally describing figurative and colorful represented spectra (monochromatic, continuous, discrete), students often named the spectrum shown or described the trend from left to right, from red to violet. Often, the spectrum was described as a curve together with its trend (such as "hyperbolic", "exponentially falling"). In addition, the intensities of different colors were compared. Occasionally, the width of the spectral range covered was described. A reference to the light source used was rarely made.

Naming categories of spectra

To build on previous lessons and reactivate prior knowledge, the students were asked to name the represented spectra. If no technical term was known, they were expected to give a short descriptive name. The technical terms were recalled only sporadically. Often, no information was remembered. Sometimes, other types of names were given. In this case, the students used associations with landscapes (for example "alpine spectrum", "stalagmite") or buildings (such as "half-pipe", "spire") or the spectrum was described as a curve (such as "hyperbolic spectrum"). Rarely, other associations were made (such as "lie detector", "ECG").

Assigning light from various lamps to categories of spectra

Tasked with assigning the investigated light sources to the above named categories of spectra, within the experiment, 65% of the students carried out all assignments as expected.

A LED color changer and a white LED lamp represented particular difficulties for the students, as was to be expected. The responses to the secondary question, "Which light sources were difficult to assign? Describe

in as much detail as possible, what you found difficult." show that the students hesitated between identifying them as monochromatic or continuous when asked to assign the spectra of the LED lamps.

Quantitative comparison of two emission lines and energy conversions

The quantitative comparison of two emission lines and the required energy conversions proved so difficult for many students of all grade levels that only few completely worked out this part of the problem.

The last task was *"Compare the two emission lines in relation to the number of measured photons, the photon energy and the corresponding total energy."*

A case study from the ninth grade provided the following response: *"Violet has higher photon energy than red-orange. However, the total energy is higher in red-orange because twice as many red-orange photons are emitted by the lamp. Nevertheless, the total energy is not much higher than in violet, because violet has higher photon energy."*

11. Discussion

The experiment on optical spectrometry via the Internet presented here can be used by ninth grade students and is useful in connection with the created material for the self-regulated introduction to atomic physics in the context of homework. Even if not all the tasks were fully completed by all the students, the described case study shows that the importance of the distinction between photon energy and radiant energy can be independently processed at ninth grade level.

Acknowledgements

The authors want to thank *Nanotec Electronic GmbH & Co KG*, Feldkirchen, Germany for supporting us with experimental hardware like stepper motors, stepper motor drivers, and power supplies. We also want to thank *Acal BFi Germany GmbH*, Gröbenzell, Germany for lending us a radiometric calibration standard. At least, we want to thank *Pusher Ltd.*, London, United Kingdom for offering us the unlimited use of their WebSocket service free of charge.

References

- Alexander, P. A., & Judy, J. E. (1988). The Interaction of Domain-Specific and Strategic Knowledge in Academic Performance. *Review of Educational Research*, 58(4), 375–404.
- Banchi, H., and Bell, R. L. (2008). The Many Levels of Inquiry. *Science and Children*, 46, 26–29.
- Bandura, A. (1997). *Self-efficacy: The exercise of control*. New York, NY: Freeman.
- Baumert, J., & Köller, O. (2000). Unterrichtsgestaltung, verständnisvolles Lernen und multiple Zielerreichung im Mathematik- und Physikunterricht der gymnasialen Oberstufe. In J. Baumert, W. Bos, & R. Lehmann (Eds.), *TIMSS/III: Bd. 2. Mathematische und physikalische Kompetenzen am Ende der gymnasialen Oberstufe*. Opladen: Leske + Budrich.
- Bransford, J. D., Brown, A. L., Anderson, J. R., Gelman, R., Glaser, R., Greenough, W. T., ...Phillips, M. J. (2000). *How People Learn: Brain, Mind, Experience, and School: Expanded Edition*: National Academy Press.
- Brown, A. L., & DeLoache, J. S. (1978). Skills, plans, and self-regulation. In R. S. Siegler (Ed.), *Children's Thinking: What Develops?*, 3–36. Hillsdale, NJ: Erlbaum.
- Brünken, R., Steinbacher, S., Schnotz, W., & Leutner, D. (2001). Mentale Modelle und Effekte der Präsentations- und Abrufkodalität beim Lernen mit Multimedia: Mental Models and Effects of Presentation and Retrieval Cue Codality in Multimedia Learning. *Zeitschrift für Pädagogische Psychologie*, 15(1), 16–27.
- Butler, D. L., & Winne, P. H. (1995). Feedback and Self-Regulated Learning: A Theoretical Synthesis. *Review of Educational Research*, 65(3), 245–281.
- Deci, E. L., & Ryan, R. M. (1993). Die Selbstbestimmungstheorie der Motivation. *Zeitschrift für Pädagogik*, 39(2), 223–238.
- Duit, R., & Tesch, M. (2010). On the role of the experiment in science teaching and learning – Visions and the reality of instructional practice. In M. Kalogiannakis, D. Stavrou, & P. G. Michaelides (Eds.), *HSci 2010. 7th International Conference Hands-on Science "Bridging the Science and Society gap", July 25-31, 2010, Greece*. Rethymno: The University of Crete.

- Eppeldauer, G. P. (1996). Near-infrared radiometer standards. In *SPIE's 1996 International Symposium on Optical Science, Engineering, and Instrumentation*. International Society for Optics and Photonics. 42–54.
- Eppeldauer, G. P., Racz, M. & Larason, T. C. (1998). Optical characterization of diffuser-input standard irradiance meters. *Proc. SPIE 3573, OPTIKA '98: 5th Congress on Modern Optics*. 220–224.
- Gröber, S., Vetter, M., Eckert, B., & Jodl, H.-J. (2007). Experimenting from a distance—remotely controlled laboratory (RCL). *European Journal of Physics*, 28(3), 127–141.
- Hofstein, A., & Lunetta, V. N. (2004). The laboratory in science education: Foundations for the twenty-first century. *Science Education*, 88(1), 28–54.
- Harlen, W. (1999). *Effective teaching of science: A review of research. SCRE publication Using research series: Vol. 21*. Glasgow: Scottish Council for Research in Education.
- Hmelo, C. E., Nagarajan, A., & Day, R. S. (2000). Effects of High and Low Prior Knowledge on Construction of a Joint Problem Space. *The Journal of Experimental Education*, 69(1), 36–56.
- Hmelo-Silver, C. E., Duncan, R. G., & Chinn, C. A. (2007). Scaffolding and Achievement in Problem-Based and Inquiry Learning: A Response to Kirschner, Sweller, and Clark (2006). *Educational Psychologist*, 42(2), 99–107.
- Hofstein, A., & Lunetta, V. N. (1982). The Role of the Laboratory in Science Teaching: Neglected Aspects of Research. *Review of Educational Research*, 52(2), 201–217.
- Jong, T. de, & Joolingen, W. R. van. (1998). Scientific Discovery Learning With Computer Simulations of Conceptual Domains. *Review of Educational Research*, 68(2), 179–201.
- Kirschner, P. A., Sweller, J., & Clark, R. E. (2006). Why Minimal Guidance During Instruction Does Not Work: An Analysis of the Failure of Constructivist, Discovery, Problem-Based, Experiential, and Inquiry-Based Teaching. *Educational Psychologist*, 41(2), 75–86.
- Kirstein, J., & Nordmeier, V. (2007). Multimedia representation of experiments in physics. *European Journal of Physics*, 28(3), 115.
- Krapp, A. (1999). Intrinsische Lernmotivation und Interesse. Forschungsansätze und konzeptuelle Überlegungen. *Zeitschrift für Pädagogik*, 45(3), 387–406.
- Krapp, A. (2005). Basic needs and the development of interest and intrinsic motivational orientations. *Feelings and Emotions in the Learning Process Feelings and Emotions in the Learning Process*, 15(5), 381–395.
- Kuhn, D. (2007). Is Direct Instruction an Answer to the Right Question? *Educational Psychologist*, 42(2), 109–113.
- Larason, T. C., Brown, S. W., Eppeldauer, G. P., & Lykke, K. R. (2001). Responsivity calibration methods for 365-nm irradiance meters. *Instrumentation and Measurement, IEEE Transactions on*, 50(2), 474–477.
- Lavoie, D. R., & Good, R. (1988). The nature and use of prediction skills in a biological computer simulation. *Journal of Research in Science Teaching*, 25(5), 335–360.
- Lazonder, A. W., Wilhelm, P., & Lieburg, E. van. (2009). Unraveling the influence of domain knowledge during simulation-based inquiry learning. *Instructional Science*, 37(5), 437–451.
- Mayring, P. (2010). *Qualitative Inhaltsanalyse: Grundlagen und Techniken* (11. Ausg.). Wein-heim: Beltz.
- National Research Council. (2013). *Next Generation Science Standards: For States, By States*. Washington, DC: The National Academies Press.
- Schauble, L., Glaser, R., Raghavan, K., & Reiner, M. (1991). Causal models and experimentation strategies in scientific reasoning. *The Journal of the Learning Sciences*, 1(2), 201–238.
- Schmidt, H. G., Loyens, Sofie M. M., Gog, T. van, & Paas, F. (2007). Problem-Based Learning is Compatible with Human Cognitive Architecture: Commentary on Kirschner, Sweller, and Clark (2006). *Educational Psychologist*, 42(2), 91–97.
- Schraw, G. (1998). Promoting general metacognitive awareness. *Instructional Science*, 26(1-2), 113–125.
- Seidel, T. Prenzel, M., Duit, R., Euler, M., Geiser, H., Hoffmann, L., Lehrke, M., Müller, C., Rimmel, R. (2002). "Jetzt bitte alle nach vorn schauen!" - Lehr-Lernskripts im Physik-unterricht und damit verbundenen Bedingungen für individuelle Lernprozesse. *Unterrichtswissenschaft*, 30(1), 52–77.
- Shavelson, R. J., Ruiz-Primo, M. A., & Wiley, E. W. (1999). Note on Sources of Sampling Variability in Science Performance Assessments. *Journal of Educational Measurement*, 36(1), 66–71.

- Sweller, J., Kirschner, P. A., & Clark, R. E. (2007). Why Minimally Guided Teaching Techniques Do Not Work: A Reply to Commentaries. *Educational Psychologist*, 42(2), 115–121.
- Tesch, M., & Duit, R. (2004). Experimentieren im Physikunterricht – Ergebnisse einer Videostudie. *Zeitschrift für Didaktik der Naturwissenschaften*, 10, 51–69.
- Weinert, F. E. (2001). Vergleichende Leistungsmessung in Schulen - eine umstrittene Selbstverständlichkeit. In F. E. Weinert (Ed.), *Beltz-Pädagogik. Leistungsmessungen in Schulen*. Weinheim: Beltz.

Affiliation and address information

Lars-Jochen Thoms
Chair of Physics Education
Faculty of Physics
Ludwig-Maximilians-Universität
Theresienstraße 37
80333 München, Germany
e-mail: l.thoms@lmu.de

Performance Task using Video Analysis and Modelling to Promote K12 Eight Practices of Science

Loo Kang Wee¹, Tze Kwang Leong²

¹Ministry of Education, Educational Technology Division, Singapore.

²Ministry of Education, Raffles Girl's School, Singapore.

Abstract

We will share on the use of Tracker as a pedagogical tool in the effective learning and teaching of physics performance tasks taking root in some Singapore Grade 9 (Secondary 3) schools. We discuss the pedagogical use of Tracker help students to be like scientists in these 6 to 10 weeks where all Grade 9 students are to conduct a personal video analysis and where appropriate the 8 practices of sciences (1. ask question, 2. use models, 3. Plan and carry out investigation, 4. Analyse and interpret data, 5. Using mathematical and computational thinking, 6. Construct explanations, 7. Discuss from evidence and 8. Communicating information). We will situate our sharing on actual students' work and discuss how tracker could be an effective pedagogical tool. Initial research findings suggest that allowing learners conduct performance task using Tracker, a free open source video analysis and modelling tool, guided by the 8 practices of sciences and engineering, could be an innovative and effective way to mentor authentic and meaningful learning.

Actual tracker files *.TRZ are down-able via Dropbox links on this links:

<http://weelookang.blogspot.sg/2014/05/tracker-koaytzemin-student-video-roller.html>

<http://weelookang.blogspot.sg/2014/05/tracker-deeakdev-student-video.html>

<http://weelookang.blogspot.sg/2014/05/tracker-wangyuxing-student-video.html>

<http://weelookang.blogspot.sg/2014/05/tracker-danielleleo-student-video.html>

<http://weelookang.blogspot.sg/2014/05/tracker-camelialim-student-video-ping.html>

Keywords

Tracker, Video Analysis, Video Modelling, 8 Practices of Science, ICT and Multi-Media in Physics Education, Pedagogical Methods and Strategies, Physics Curriculum and Content Organization, Physics Teaching and Learning at Elementary, Secondary and University Levels.

1. What

We used the K12 science education framework¹ to guide our use of the video analysis² and modelling³ approach to allow students to be like scientists.

2. Why?

Table 1: Comparison of traditional lessons versus the scientist research

<i>Traditional Lessons</i>	<i>Scientist Research</i>
Topics taught in isolation	Knowledge from various topics are required
Simplified theoretical scenario with many assumptions	Authentic collected data which often include anomaly
Knowledge apply to assessment questions Teacher directed;	Knowledge apply to real world situations Student directed;
Teacher decide on question	Ownership of research question
No differentiation; One size fits all	Research is individualized

Table 1 summarise the various reasons why high school science education should consider incorporating elements of the scientists' research as about a 10 week duration performance task as we speculate traditional lessons generally have weaknesses (Table 1 LEFT) in allowing students to experience⁴ physics phenomena of the student's choice.

3. How?

Flip video

A series of YouTube instructional video were created by the authors to demonstrate simpler tasks such as a) installing Tracker b) generate s vs t , v vs t and a vs t graphs and c) analyse graphs by finding gradient¹ and area².

Classroom activities

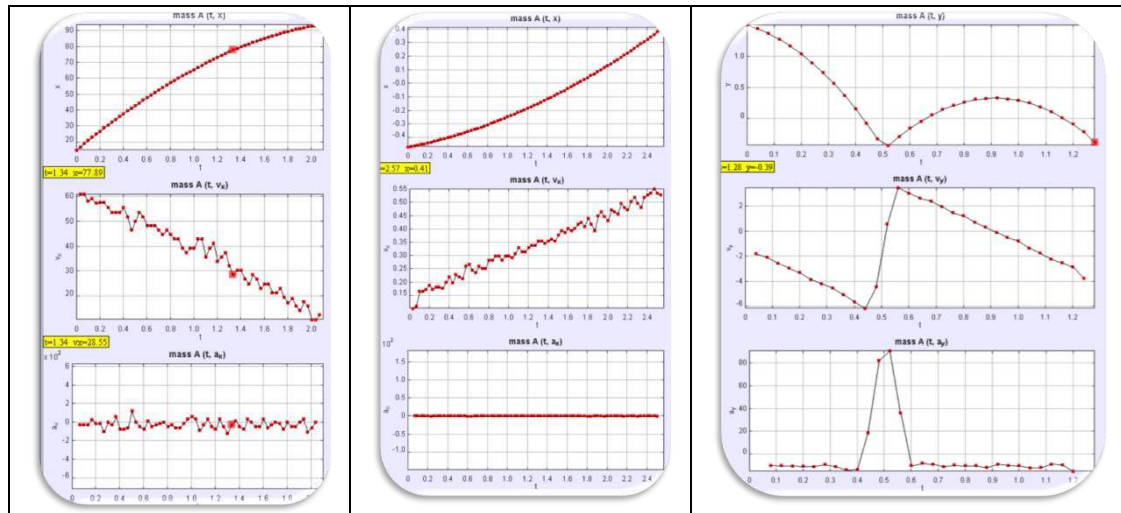

Figure 1. Left to right: a) cart push on level slope slowing down at constant negative acceleration) b) cart on slope speeding up at constant acceleration and c) bouncing ball, complex accelerating motion divided into phases.

A set of 3 video analyses (0) were provided to the students in groups of 3-4, where they will discuss, present and critic on the other groups' presentation. As students were introduced to Tracker's interface in the flip video at their own free time earlier on, the lessons stand a higher chance of allowing richer discussions in class. The selected video are a) cart push on level slope slowing down at constant negative acceleration) b) cart on slope speeding up at constant acceleration and c) bouncing ball, complex accelerating motion divided into phases.

Primer Scientist Activity

We also conducted a primer hands-on activity where a set of equipments (2 marbles, a ramp, metre rule etc) where students need to behave like a beginning scientists (0) such as

- Practice 1: Define a problem
- Practice 3: Plan out an investigation
- Practice 4: Analyse and interpret the data
- Practice 6: Construct explanations

Some interesting student's asking own questions involves experiments such as marble rolling up and down a ramp, bouncing marble down stairs or slope, projectile marble colliding with wall and colliding marbles³.

¹ https://www.youtube.com/watch?v=H_zrk116BNs

² https://www.youtube.com/watch?v=7_TgOSMqRQs

³ https://www.dropbox.com/s/4ypouk5hgc69hww/304-307valarylimmarble_analysisandmodel.trz

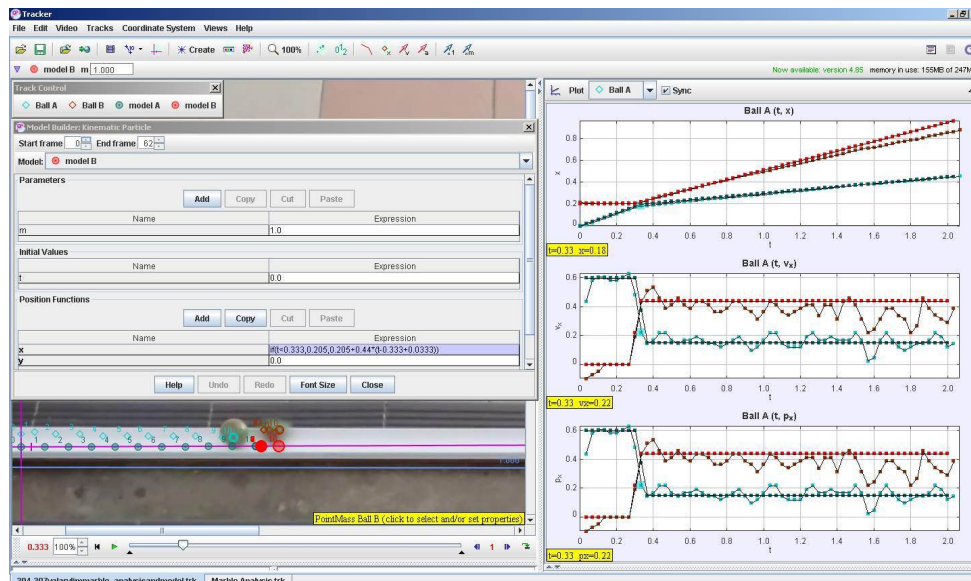

Figure 2. Students directed video analysis inquiring on the inelastic collision of 2 marbles on a track. Teal trail is the right moving marble and the Red trail is the right moving marble. Model A and B were added on later by the authors for teacher professional network learning purposes.

Dynamics Topic integrative lesson from Kinematics

Revisit gentle push on horizontal slope

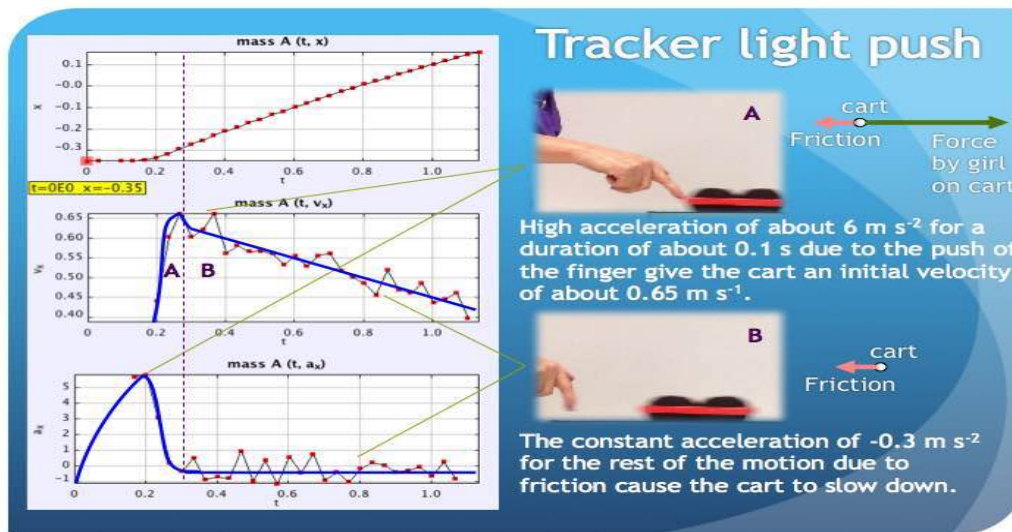

Figure 3. A dynamics lesson using tracker again to illustrate frictional forces bridging from kinematics topics allows students to build understanding based on what they have already experience themselves in kinematics topics with the now more familiar tracker x vs t , v_x vs t and a_x vs t graphs.

Students were asked to suggest what forces cause the motion where all previous kinematics videos are revisited to discuss the dynamics (0). There was no enough time for teacher professional development⁵ this year but the authors recommend getting students to use the Tracker's Dynamics model builder to incrementally suggest better models that represent the motion under investigations that has both practice 5: mathematical and computational thinking.

Practice 5: Mathematical thinking

For example, to model frictional force motion (0) of the cart moving horizontally, students can mathematically determine the gradient of the v_x vs t graph to determine acceleration in the x direction, a_x .



Figure 4. Tracker DataTool showing a Fit Line of $v_x = -0.2456*t + 0.7022$.

Practice 5: Computational thinking⁶

Having determined ax and knowing mass of cart to be $m = 0.2 \text{ kg}$, the computational line (0) with the if statement allows the push force $fx = 3.2*m$ from $t=0$ to 0.2 s , and frictional force $fx = -0.246*m$ to be present after time t is greater than 0.2 s .

$$fx = \text{if}(t < 0.2, 3.2*m, -0.246*m)$$

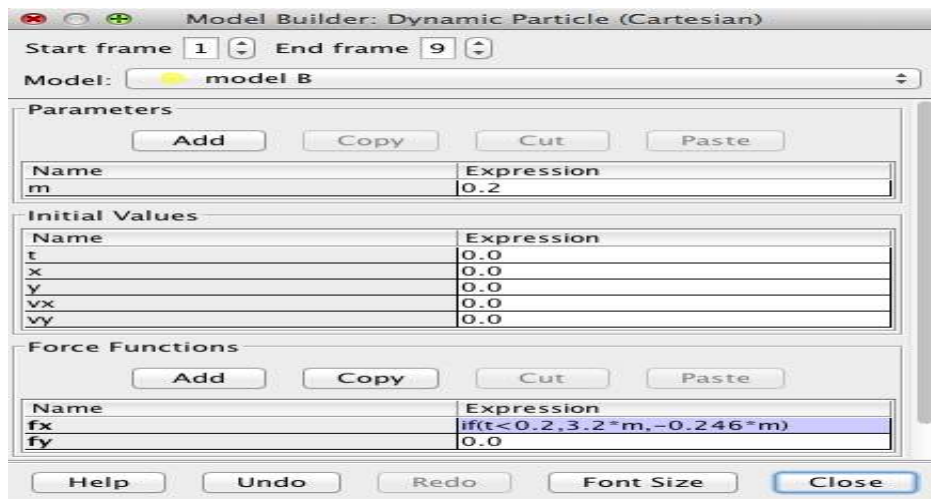

Figure 5. Tracker Dynamics Model Builder interface showing mass $m = 0.2 \text{ kg}$ and force model $fx = \text{if}(t < 0.2, 3.2*m, -0.246*m)$.

Atwood Machine

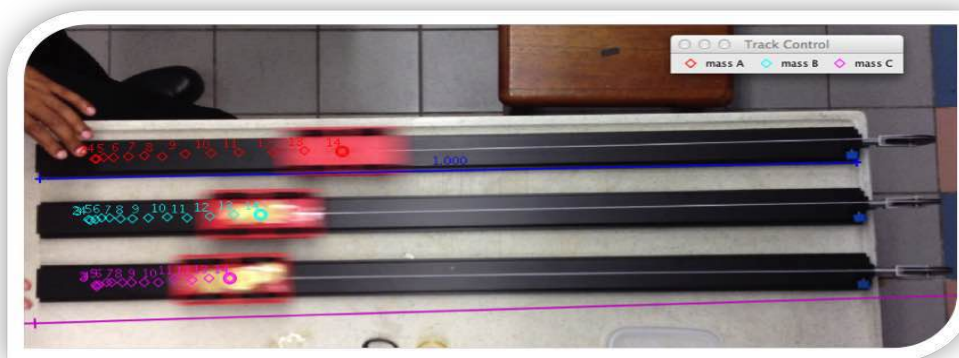

Figure 6. Atwood Machine video showing 3 different mass, m carts, pulled by the same weight F (RIGHT) and their respectively accelerations a_x .

Another example we tried was the Atwood machine (0) where 3 carts of different mass are pulled by identical weights. This activity aims to allow students to modelling instruction teaching approach to arrived

at a social meaning making process that the resultant force F pulling the carts is related to the carts' acceleration a and the mass of the carts as in Newton's second law.

$$F = ma$$

Assessment of Performance Task

Meaningful Scenario

We gave the students the scenario that mimics real scientists. For example, "You are a scientist who is tasked by A*Star (A local Research initiative) to explain a complex motion and the cause of the motion. You are to record a video of a moving object and to analyze the kinematics and dynamics involved in the motion with the aid of Tracker software. Your report will help the scientific community better understand the complex motion."

Assessment Rubrics(20% of exam score)

Table 2: Assessment Rubrics communicating clearly the expected performance indicators of excellent task. We found a constantly reference to assessment rubrics, see Table 2, to be able to provide the extrinsic motivation to get students to perform their own performance video tasks.

ASSESSMENT RUBRICS ON PT ON ANALYSIS OF MOTION USING VIDEO TRACKER YEAR THREE (RP PHYSICS)					
Level Criteria	Excellent (4m)	Proficient (3m)	Adequate (2m)	Limited (1m)	Insufficient / No evidence (0m)
Identify motion to be investigated (C1)	Identify a motion that is complex and well defined and involve non-rigid body, multiple objects or multiple phases	Identify a complex motion that is well defined .	Identify a motion that is well defined .	Identify a motion that is ill- defined .	
Plan the procedure and filming (C2)	Use a comprehensive and detailed procedure to film object in order to ensure precision and accuracy of measurement.	Use a clear and workable procedure to film object in order to ensure precision and accuracy of measurement.	Use a simplistic procedure to film object with some consideration of accuracy of measurement.	Use an ambiguous procedure to film object with little consideration of accuracy of measurement.	
Present graphs with annotation (C3)	Present graphs logically and clearly in an appropriate form with relevant annotation .	Present graphs reasonably well in an appropriate form with relevant annotation .	Present relevant but incomplete set of graphs	Present graphs with severe conceptual error .	
Provide a	Provide a detailed	Provide a	Provide a	Provide a	

discussion of the motion (C4)	and comprehensive discussion of the motion.	relevant discussion of the motion with no errors .	discussion of motion with some minor errors .	discussion of motion with severe conceptual errors .	
Explain the forces in relation to the motion (C5)	Explain the forces in relation to the motion by consistently making accurate inferences from graphs and video.	Explain the forces in relation to the motion by making some accurate inferences from graphs	Explain the forces in relation to the motion by making inferences from graphs with some errors .	Explain the forces in relation to the motion by with little attempt to make inferences from graphs.	

Close Teacher Mentorship

For the learning to go well, we find that a weekly schedule consultation time-table to be useful as students are given opportunities to discuss their analysis with the teachers both in class and outside class. Suggestions were made by teachers to refine their video, given direction for further readings or suggestion on analysis.

Students' Pre-Post Perception Survey

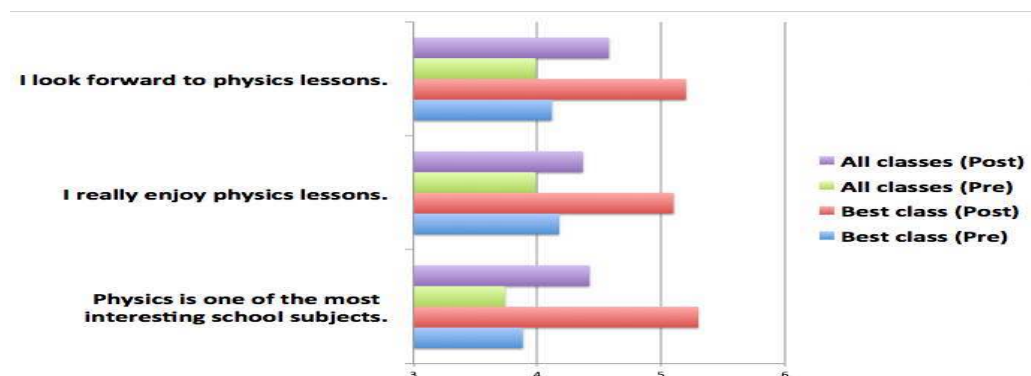

Figure 7. (N=273 pre-post) Students' perception survey on a Likert scale from 1 (strongly disagree) to 6 (strongly agree), middle is 3.5 point

Our initial analysis of N=273 students' pre-post perception survey on the experience of the performance task suggests only the best class registered a significant positive change (0) in the affective domains like "I look forward to physics lessons", "I really enjoy physics lessons" and "Physics is one of the most interesting school subjects" etc while the 273 students in the Secondary three level had smaller positive changes in the self reporting perfection survey.

More sample tracker files *.TRZ are down-able via Dropbox links on this links:

<http://weelookang.blogspot.sg/2014/05/tracker-koaytzemin-student-video-roller.html>

<http://weelookang.blogspot.sg/2014/05/tracker-deeakdev-student-video.html>

<http://weelookang.blogspot.sg/2014/05/tracker-wangyuxing-student-video.html>

<http://weelookang.blogspot.sg/2014/05/tracker-danielleteo-student-video.html>

<http://weelookang.blogspot.sg/2014/05/tracker-camelialim-student-video-ping.html>

4. Conclusion

This paper describes the what, why and how we promoted our students to be more like scientists in the context of our Secondary Three Physics performance task using Tracker and K12 Science Framework to guide our approach. The creative commons attribution resources we have created through our mentorship and lesson packages developed, forms the Singapore Tracker Digital Library collection downloadable

through Tracker as a Shared Library (0) as well as the following URL <http://iwant2study.org/lookangejss/> for the benefit of all.

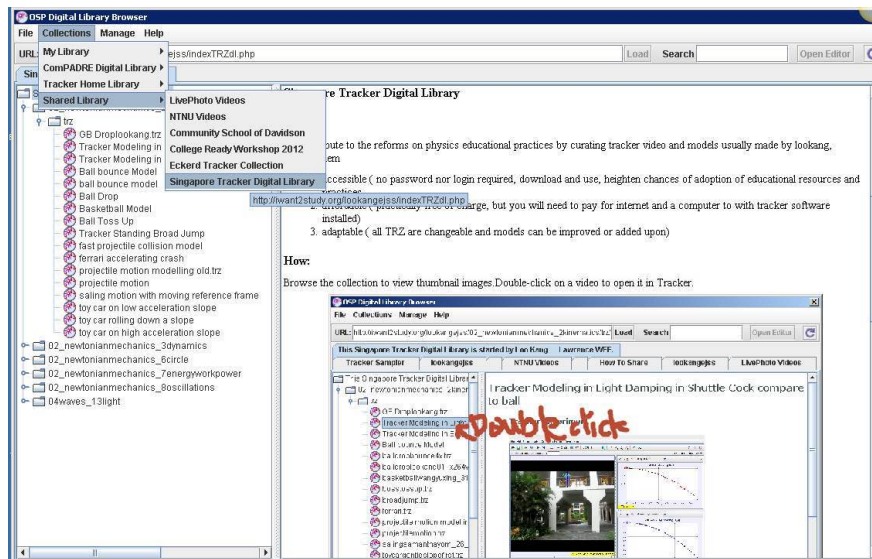

Figure 8. Officially in Tracker as Shared Library <http://iwant2study.org/lookangejss/indexTRZdl.php>

Acknowledgement

We wish to acknowledge the passionate contributions of Douglas Brown, Wolfgang Christian, Mario Belloni, Anne Cox, Francisco Esquembre, Harvey Gould, Bill Junkin, Aaron Titus and Jan Tobochnik for their creation of Tracker video analysis and modeling tool.

This research is made possible; thanks to the eduLab project NRF2013-EDU001-EL017 Becoming Scientists through Video Analysis, awarded by the National Research Foundation, Singapore in collaboration with National Institute of Education, Singapore and the Ministry of Education (MOE), Singapore.

References

- [1] Quinn Helen, Schweingruber Heidi, and Keller Thomas, *A Framework for K-12 Science Education: Practices, Crosscutting Concepts, and Core Ideas*. (The National Academies Press, Washington, DC, 2012).
- [2] Douglas Brown, "Tracker Free Video Analysis and Modeling Tool for Physics Education", (Open Source Physics compADRE, USA, 2012); Loo Kang Wee, Tracker Video Analysis: Bouncing Ball (2012).
- [3] Loo Kang Wee, Charles Chew, Giam Hwee Goh, Samuel Tan, and Tat Leong Lee, "Using Tracker as a pedagogical tool for understanding projectile motion," *Physics Education* **47** (4), 448 (2012); Wolfgang Christian and Francisco Esquembre, "Computational Modeling with Open Source Physics and Easy Java Simulations", in *South African National Institute for Theoretical Physics Event* (University of Pretoria, South Africa, 2012).
- [4] Loo Kang Wee, "One-dimensional collision carts computer model and its design ideas for productive experiential learning," *Physics Education* **47** (3), 301 (2012).
- [5] Loo Kang Wee and Tat Leong Lee, "Video Analysis and Modeling Tool for Physics Education: A workshop.", in *4th Redesigning Pedagogy conference* (National Institute of Education, Nanyang Technological University, Singapore, 2011).
- [6] Loo Kang Wee, "Open Educational Resources from Performance Task using Video Analysis and Modeling-Tracker and K12 science education framework", in *8th Joint Meeting of Chinese Physicists Worldwide (OCPA8)* (Nanyang Technological University, Singapore, 2014), Vol. arXiv preprint arXiv:1408.5992.

Affiliation and address information

Loo Kang Lawrence WEE

Ministry of Education, Educational Technology Division, Singapore.
1 North Buona Vista Drive, Singapore 138675, Singapore
e-mail: lawrence_wee@moe.gov.sg

Chapter 6

In-Service and Pre-Service Teacher Education

Project-Based Learning for Teacher Education in Brazil's State with the Lowest Literacy Rate

Marcos Henrique Abreu de Oliveira¹, Mara Fernando Parisoto², Robert Fischer¹

¹ Instituto Federal de Alagoas - IFAL, Brasil

² Universidade Federal do Rio Grande do Sul – UFRGS, Brasil

Abstract

Alagoas' educational system is among the worst performing in the world. To improve the situation for future generation of students, a better education for teachers is needed. While, for many years, teacher training in the region includes a theoretical discussion of modern didactic tools and methodologies, there exists a large gap between what future teachers hear at university and what they actually practice in their teaching. In this work we report on a pilot course to apply modern teaching methodologies during and as part of teacher training itself. More specifically, we employed Project Based Learning in an evening course for working adults aimed at training maths teachers in Alagoas.

Keywords

Mathematics, Project Based Learning, Educating Working Adults.

1. Introduction

When in 1941, Stefan Zweig, an Austrian novelist, famously titled a book 'Brazil, Land of the future', he inspired Brazilians to the still common joke that "Brazil is the country of the future – and always will be". The stagnated economic progress of this resource rich country, which features relative political stability and a potentially huge internal market, can be mainly attributed to its lack of an educated workforce. According to the Brazilian Federation of Industry (CNI, 2015), in 2013 only 48.7% of Brazil's industry workers have finished secondary education. The same report points out that in Alagoas, a state in the North-East of Brazil, this holds true for merely 18.9 % of the industry workers. A survey conducted in 2011 by the Brazilian government found that 24.6% of the Alagoan population above the age of 15 is illiterate and a total of 26.5% functionally illiterate (IBGE, 2012). Correspondingly, the students in Alagoas showed the worst results in all 3 areas (mathematics, literature and science) assessed by PISA in 2012 in Brazil (OECD, 2013b). Moreover, for all three areas their results are even below the respective score in any of the 65 countries and economies around the globe participating in the study (OECD, 2013a).

Addressing this urgent socioeconomic problem clearly begins with well trained and equipped teachers who inspire their students to become an educated part of this promised 'Land of the future'. One would therefore expect that improving teacher formation is a priority, and that future teachers receive the methodological, didactic and technical tools to incite their students to meaningful learning. Unfortunately, the very teacher formation courses consist of lectures upon lectures on theoretical discussions of methodology – yet never 'do as they preach', i.e. apply the advanced methodologies during the course itself. New teachers thus arrive at school without ever having seen or even experienced these methods in practice. It comes at no surprise that there is a big gap between what future teachers hear at university and what they actually do in class.

In this work we tested the hypothesis if applying teaching methodologies during the teacher formation increases the chances that new teachers later on will apply these methods themselves. We selected Project Based Learning (PBL) as the test-methodology and applied it in a class of mathematics 'licenciatura' students in the second half of 2013 at the Instituto Federal de Alagoas - IFAL (Alagoas' Federal Institute). In Brazil, 'licenciatura' courses prepare students as future teachers in a specific subject. Although trained as math teachers, recent research shows that these new teachers are very likely to be employed to teach science subjects such as physics, chemistry, and at times biology (Fischer, Fireman, & Gomes, 2013). The specific course chosen from the math licenciatura curriculum for this test was 'science education' (preparing for the teaching of interdisciplinary 'science' classes at primary schools), with 3 contact-hours per week, attended by 13 adult students in evening classes. This research was designed to pilot the approach of applying

different teaching methodologies at IFAL's teacher formation and identify the best way to embed it in the curriculum.

2. Methods

PBL is a didactic method that is known to increase most student's engagement and foster skills (Hattie, 2013; Planinšič, 2007), which is an increasingly important aspect in teaching (Bruns, Evans, & Luque, 2011). It is therefore a valuable tool in a teacher's toolbox and is discussed, in various variations, in many teacher education programs. In our research, we used Carl Roger's framework (Rogers, 1978), because of his emphasis on students bringing their own knowledge to the investigation and learning context, which combines well with andragogy (the majority of the course participants were over 30 years old). Malcolm Knowles (Knowles, 1970; Knowles, III, & Swanson, 2005) identifies the prerequisites for a successful formal learning situation with adults as: establishing a climate of mutual respect for each other's experience; involving the learner in the planning and evaluation of her instruction, clearly explaining the purpose and relevance of the learning objectives, and teaching problem-centered rather than content-oriented. Paying attention to the learning characteristics of this period of life (Coll, Palácios, & Marchesi, 1995), PBL is a suitable tool to incorporate the student's knowledge from work, hobbies, and personal interests into the learning experience, and, at the same time, to relate this knowledge and interests to the math and science teaching context and thus to their future professional activities.

The organization of the projects was purposefully held formal, to help the students develop valuable skills and abilities for their future profession, such as the capacity to work in groups, to write clear and objective reports, meet deadlines, gain intellectual independence and embrace the personal responsibility for their own learning. It has to be taken into account that almost all 'licenciatura' course participants at IFAL are working adults with family obligations, attending the course in evening classes. Due to competing duties at work, home and university, their course attendance is sometimes irregular and marked by fatigue, as observed by Togni and Carvalho (Togni & Carvalho, 2007). The course design therefore foresaw a limited time spend on course related activities outside the regular classes.

3. Theoretical Framework

Considering the formal learning context described above, Ausubel's theory of meaningful learning (Ausubel, 2000) can be applied to the discussed implementation of Carl Roger's project method (Rogers, 1978), which we choose as base for developing our PBL approach in teacher formation. Reflecting the course layout with these concepts helps to analyze the educational gain for the students and identify areas of improvements.

3.1 Meaningful Learning

According to Ausubel, the prior knowledge of students is the most influential variable in the learning process. In order to facilitate meaningful learning, it is therefore essential to gain an insight into the students knowledge and then teach accordingly. He goes as far as saying: "Teaching and learning are not coextensive – teaching is only one of conditions which may influence learning". (Ausubel, Novak, & Hanesian, 1978, p.14).

Moreira (Masini & Moreira, 1982), commenting Ausubel, explains that the central idea of this theory is the crucial influence of the learner's prior knowledge on the learning process. Each individual faces learning tasks with a already developed cognitive structure, and new information will be anchored on this structure when the learner interacts with them. This processes of anchoring new information to segments of the preexisting structure is called subsumption. Ausubel himself explain that

"In meaningful learning the very process of acquiring information results in a modification of both the newly acquired information and the specifically aspect of cognitive structure to which the new information is linked. In most instances new information is linked to a relevant concept or proposition. ... We will employ the term anchorage to suggest the role of the preexisting idea." (Ausubel, Novak, & Hanesian, 1978, p.57).

Ausubel (Ausubel, Novak, & Hanesian, 1978, p.41-44) identifies two basic conditions for meaningful learning taking place:

- a) The new material to be learned must be relevant to the apprentice;
- b) The apprentice must demonstrate a willingness to relate the new material non-arbitrarily and substantively to his cognitive structure.

Also according to Ausubel (Ausubel, 2000), the process of detailing, refinement and specification of a subsumer is called the *progressive differentiation* principle. In this concept, we start from the general (most important) and progress towards the specific (through examples, exercises and others situations). On the other hand, the process of exploring the links between knowledge, recombining them and relating them, seeking the differences and similarities between them, is known as *integrative reconciliation*.

3.2 Carl Rogers' and Oswaldo Frota-Pessoa 's approach of PBL

Carl Rogers, a psychologist, developed the so-called Project Method (Rogers, 1978) as a predecessor of PBL. For Rogers, people are intrinsically motivated. Unfortunately the educational system often forces students to learn what is considered relevant for the social and economical system, but not what the student himself considers relevant and motivating.

Nowadays technology and science changes rapidly. There is a lot of knowledge being produced permanently, so it is essential that people be able to learn how to learn, to search, to pursue knowledge itself, and to become responsible for their own learning. Formal education is only temporary and acquiring new knowledge and skills needs to be continued by an intellectually independent learner long after finishing school. Rogers states that "the only man who is educated is the one who has learned how to learn, how to adapt and change, the one who knows that no knowledge is secure, that no process of seeking knowledge gives a basis for security" (Rogers, 1978). In order to help students to 'learn how to learn', Rogers develops his project method around 6 principles, which also were used to develop the PBL lesson plan for our research: 1. In order to facilitate self-initiated learning, the student needs to face a problem that he recognizes as relevant for himself. 2. The teacher's responsibility is to provide adequate resources. 3. Students sign a contract detailing the project and learning objectives. 4. Students work in learning facilitating groups. 5. The teacher builds a positive environment, providing assistance and guidance without restricting independent learning. 6. The teaching approach makes use of simulations of real-world situation.

Another important author, related to the Project Method, is Oswaldo Frota-Pessoa (Frota-Pessoa, 2001). His work in this area has been very influential in Brazil. While his suggestions are in agreement with Rogers' recommendations, he added that this kind of practice must consist of short, successive jobs, developed by teams that should generate reports, and these reports, at least partially, will make up the review. He says these projects should be presented, for example, in science fairs, or in a comparable classroom setting to the peers. He stresses the importance of the group's responsibility to decide the project topic, plan its execution, manage its progress and report upon completion. According to Frota-Pessoa, the projects should be related to a common theme, which in the case of this our research, was the development of a tangible educational tool for primary school science education.

3.3 Application to the course design

Combining the concepts from Ausubel, Rogers and Frota-Pessoa, the course layout encouraged students incorporate their professional experience and personal interests, which John Dewey (Dewey, 1929) aptly called 'dawning capacities', in their project work. The implementation of PBL was accompanied by theory lessons that provided the necessary background on writing projects, reports, and meeting minutes, on managing group work and presenting results. The theory lessons also discussed the quality metrics of educational material for primary school settings, such as developed by the groups in their projects. This allowed for a more formal organization of the PBL, including the writing of project proposals (including the contractual commitment suggested by Rogers) and reports, as well as to document the project progress and the contribution of the team members by meeting minutes. Students presented their work in an intermediate progress report as short presentation with projected slides and a concluding 'fair' at the course end (as encouraged by Frota-Pessoa). Relative to younger secondary-level learners, a much greater importance in the course design was laid on self- and peer-evaluation; already for the practical reason that a fair evaluation of project work is one of the greatest challenges the new teachers will face when applying PBL later on in class.

4. Results

Overall, the PBL approach was very well received by the students. None of the students had previously experienced PBL or a similar methodology. The 6 groups developed educational resources for teaching science in form of 1. a solar powered water heater; 2. a board game for teaching math; 3. a low-cost distiller for chemistry classes; 4. a wind turbine to generate electrical energy; 5. an electromagnetic cannon; 6. a filter to generate portable water from rainwater (not completed during the course). Since the students will graduate in at least two years after the test, it is not possible to verify in how far they use this methodology or the educational tools they produced in their own teaching practice. However, a preliminary evaluation can be

derived from the statements made by the students, the teacher and an external observer who will later on evaluate the student's production in a more detailed study.

4.1 From the teacher's perspective:

The students were committed to the project in a surprising way, and demonstrated a positive attitude towards PBL methodology. Although most students (except two) had no teaching experience, they developed projects produced tangible educational tools suitable for teaching science at primary schools. However, I observed that most of the students lacked a deeper understanding of the science they were discussing. The course design was not successful at motivating the students to conduct research beyond the very minimum necessary to complete the project. Before PBL can be integrated in the curriculum, several changes have to be made in the course design and the curriculum. In order to translate the content of pedagogical theory into practice, students have to be confronted with PBL much earlier, beginning in the first half of the undergrad curriculum, and then continue to practice it throughout the formation. A single course is insufficient.

4.2 From the student's perspective:

The student's comments after the final project presentation highlight five recurring themes:

- 1) Connecting educational and social reality: "The construction of the [solar powered water] heater improved the condition of my family because it has brought some electricity saving. Today we wanted to bring the heater [to the presentation in class], but it is already installed in my home and my wife is now using it."; "We chose to develop a wind generator because in our state there are innumerable houses without electricity, especially in the countryside ...";
- 2) Understanding of PBL: "In the beginning we did not know what a project was, we couldn't make evaluations of our own work or the work of others, after all, we are used to be judged by others, and we did not know how to make a presentation [...] With the PBL methodology we created something new [a board game to teach math] and presented the project in an academic congress. With the teacher's support we are writing our first article of many we intend to do";
- 3) Self-efficacy: "When the teacher told us we could choose any subject to study I was paralyzed, not knowing what to do [...] In the beginning it was difficult, but together with my colleagues... [...] I also had to help some of my colleagues how to learn";
- 4) Assessment, feedback and reflection: "I had the responsibility to criticize myself and criticize the work of others. This is a hard work because we are not used to giving and receiving criticism. I was afraid that my colleague would get upset with my feedback, but, over time, we were seeing this as a useful evolution of our learning. Criticism, over time, became more natural";
- 5) Confidence to use PBL in class: "Based on the [short] time we've been working with PBL, I don't feel myself prepared to teach with this methodology. I think we need more subjects taught with this method ...".

4.3 In the external researcher's view:

"There were no observable dropouts with respect to the discipline or to projects, which were chosen and developed entirely by the students. With the exception of one group (water filter), the projects were completed and evaluated positively. Nevertheless, students showed deficiencies in conceptual knowledge as well as problems in completing the final reports with the information obtained from the meeting minutes. We observed that most students were inexperienced in basic methods to structure documents about their work. There were also significant differences between groups, their work approaches, in-group communication and activities carried out: Some groups, which had a regular class attendance, consisted of members who were committed to the project and produced good documentation. But the group members had to realize half way through the course that their goals were unachievable within the given timeframe. In contrast, another group had set for itself clear and achievable goals. They also consisted of committed members, who, though not always present in class, progressed rapidly, and even tested the prototype of the game they developed with students at an elementary school (one of the members has been working in this school as math teacher). Yet another group consisted of silent workers. Although their project planning observed in the classroom seemed to be weak and making only slow progress, this group demonstrated a high commitment to their work, held frequent meetings at student's homes and obtained excellent results in the end.

While in general the course participants developed a positive attitude towards PBL, they did not consider themselves sufficiently prepared to implement this methodology in their future professional activities. A single course in the curriculum using the PBL approach appears therefore insufficient to really move the participants to apply this didactic method themselves."

5. Conclusion

In order to address severe educational problems as they can be observed in Alagoas, it is essential to reform and improve the teacher formation process. Most of the professors training new teachers have gone to school at a time when the educational system was even worse than the current state, which is clearly marked by critical deficiencies, and have thus never experienced modern methodologies such as PBL at class. Likewise, students attending today the classes for teacher formation have never seen these methodologies in practice. To bring advanced teaching techniques and didactics to school, it is therefore important that future teachers experience them during their training.

In our research, which is meant to pilot such changes in the teacher training curriculum at a local institution, we found that using PBL is highly motivating for participating students, and that it helps them to relate their prior knowledge to the concepts they will later teach children in maths and science. The developed course layout is compatible with working adults studying at evening classes. However, students, teacher and an external researcher agree that a single course implementation of PBL is insufficient to prepare the participants for applying this method themselves. We also noted that the gain in conceptual knowledge was below the expectations, and that these deficiencies would need to be addressed by either adaptations in the course layout, demanding more research from students, or would need to be compensated in other courses.

References

- Ausubel, D. P. (2000). *The Acquisition and Retention of Knowledge: A Cognitive View* (2000 edition). Boston: Springer.
- Ausubel, D. P., Novak, J. D., & Hanesian, H. (1978). *Educational Psychology: A Cognitive View* (2nd ed.). New York: Holt, Rinehart and Winston.
- Bruns, B., Evans, D., & Luque, J. (2011). *Achieving World-Class Education in Brazil: The Next Agenda*. The World Bank.
- CNI. (2015). *Perfil da indústria nos estados* (p. 220). Confederação Nacional da Indústria.
- Coll, C., Palácios, J., & Marchesi, A. (1995). *Desenvolvimento psicológico e educação: psicologia evolutiva*. Artes Médicas Editora.
- Dewey, J. (1929). My pedagogic creed. *J. Natl. Educ. Assoc.*, 18(9), 291–295.
- Fischer, R., Fireman, E., & Gomes, J. R. (2013). Who teaches science in Alagoas? A quantitative analysis of non-specialist teaching at primary and secondary schools in Brazil. *B Phys. Educ.*, 1, 80–91.
- Frota-Pessoa, O. (2001). *Oscaminhos da vida I, II e III—Biologia no Ensino Médio*. São Paulo: Scipione.
- Hattie, J. (2013). *Visible Learning: A Synthesis of Over 800 Meta-Analyses Relating to Achievement*. Routledge.
- IBGE. (2012). *Pesquisa Nacional por Amostra de Domicílios, Síntese de indicadores 2011*. Instituto Brasileiro de Geografia e Estatística.
- Knowles, M. S. (1970). *The modern practice of adult education* (Vol. 41). New York: New York Association Press.
- Knowles, M. S., III, E. F. H., & Swanson, R. A. (2005). *The Adult Learner* (6th ed.). Amsterdam: Butterworth-Heinemann.
- Masini, E. F. S., & Moreira, M. A. (1982). *Aprendizagem significativa: a teoria de David Ausubel*. São Paulo: Moraes Ltda.
- OECD. (2013a). *PISA 2012 Results in focus*. Paris: Organisation for Economic Co-operation and Development.
- OECD. (2013b). *Relatório Nacional PISA 2012 Resultados brasileiros*. São Paulo: Organisation for Economic Co-operation and Development.
- Planinšič, G. (2007). Project laboratory for first-year students. *European Journal of Physics*, 28(3), S71. <http://doi.org/10.1088/0143-0807/28/3/S07>
- Rogers, C. (1978). *Personal Power: Inner Strength and Its Revolutionary Impact*. London: Trans-Atlantic Publications.
- Togni, A. C., & Carvalho, M. J. S. (2007). A escolaridade de ensino médio no Brasil. *Revista Iberoamericana de Educación*, (44), 61–76.

Affiliation and address information**Marcos Henrique Abreu de Oliveira**

Instituto Federal de Alagoas - IFAL
CEP: 57035-350, Maceió - Alagoas, Brasil
marcosabreu12@gmail.com

Mara Fernando Parisoto

Universidade Federal do Rio Grande do Sul – UFRGS
CEP: 91509900, Rio Grande do Sul – Porto Alegre, Brasil
marafisica@hotmail.com

Robert Fischer

Instituto Federal de Alagoas - IFAL
CEP: 57035-350, Maceió - Alagoas, Brasil
robert@septo.ifal.edu.br

The European TEMI Project Involves Italian Teachers: First Outcomes

Sara R. Barbieri, Marina Carpineti, Marco Giliberti

University of Milan, Italy.

Abstract

The aim of the European project TEMI (Teaching Enquiry with Mysteries Incorporated) is to help transform science and mathematics teaching practice in Europe, by giving teachers new skills to engage their students and exciting new resources together with the extended support needed to effectively introduce inquiry based learning into their classrooms.

In the present work, we will illustrate the pilot training session, performed by the University of Milan and addressed to a cohort of 14 secondary school teachers. During the session, teachers directly experienced a guided inquiry IBSE and became familiar with the method that they would subsequently implement with their students.

Here we will discuss strengths and weaknesses of the pilot cohort in order to refine the method implemented in the first cohort and to improve the results of the subsequent sessions planned by the project. Besides, we propose some results of the final test given to teachers to get an evaluation of the first training cohort.

Keywords

Pedagogical methods and strategies, in-service and pre-service teachers' training.

1. Introduction

In this work we describe the first training activity developed in the framework of the European project TEMI (Teaching Enquiry with Mysteries Incorporated) [TEMI, FP7/2007-2013]. The project, that involves 13 European partners in 10 different countries (United Kingdom, Ireland, Norway, Netherlands, Germany, France, Austria, Portugal, Israel and Italy) has the aim of implementing innovative training programmes (called inquiry labs) for teaching teachers a new methodology based on inquiry and, more in particular, on the 5E's learning cycle [Rocard report, 2007]. The general structure of an inquiry lab, that has been shared by the partners except for local needs, is based around the core scientific concepts and emotionally engaging activities of solving mysteries, i.e. exploring the unknown.

An inquiry lab consists of a preliminary phase, in which teachers are given written material (in local language) about IBSE and the 5Es cycle, plus two workshops, of 8 hours each, addressed to 10-15 teachers, and temporally separated by about 2 months, in order to permit teachers to implement in their classrooms the innovations discussed in the first workshop. The structure should facilitate the development of teachers' skill and make their teaching/learning process more alive.

As it is better described in the following, each of the two workshops treats two peculiar innovation of the TEMI project.

- Workshop1 deals with the importance of the students' engagement through mysteries, the enquire teaching/learning using the 5E's learning cycle, some basic notions about showmanship, how to plan an inquiry lesson; presentation and peer review.
- Workshop2 deals with the importance of *how* to refine inquiry lessons by means of the typical TEMI innovations, that is by: mysteries, 5Es and showmanship. Moreover workshop2 adds a particular attention to the GRR model, for the gradual release of the responsibility from teachers to students, in a way similar to what happened in the past when teaching and learning were realized through apprenticeship.

Each of the two workshops can be held in one day time, or divided into two afternoons, or sessions, according to teachers' needs. This last option was the one we adopted for our pilot training cohort in Milan. It was addressed to 14 supply teachers (2 physicists and 12 engineers) who were following university courses to get a qualification to become regular teachers, and with an almost poor disciplinary preparation, as it emerged from a pre-test and some oral interviews.

In the last part of this paper we present some outcomes of an evaluation form given to teachers at the end of the second workshop, in order to get some ideas about the effectiveness of the training.

2. Workshop 1

In workshop1, teachers become familiar with inquiry teaching, especially by means of the use of mysteries and by the appropriation of the 5E's learning cycle. The contents of this first phase are resumed in Fig.1. Teachers observe a TEMI-trainer who engages them with a mystery and uses the 5E's cycle to solve the proposed mystery. Therefore, in this phase, the trainer has a very important role for what concerns the description of the activities indicated in the 5E's cycle. Being the active role of the teachers in training quite reduced, workshop1 can be considered a practical example of level 1 inquiry, also called 'confirmation' inquiry.

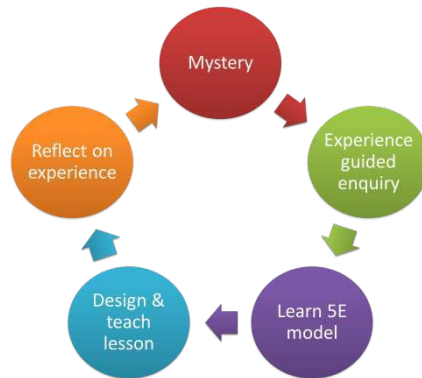

Figure 1. Schematic representation of the workshop1 contents.

The two main innovations that teachers should learn after workshop1 are, therefore, the importance of creating curiosity and motivation in students by means of the presentation of mysteries, and the investigation of mysteries by means of the 5E's cycle.

3. The 5E's learning cycle

In Fig.2 it is showed the 5E's learning cycle that is widely discussed in the literature (see for example [Bybee, 2006]). It puts in evidence the principal phases of an inquiry approach to solve problems. Although it is a cycle, it must not necessarily followed in just one direction, from the engage phase to the evaluate phase; in fact, for example it is possible to go back and forth between the explore phase and the explain phase until an idea for the resolution of the mystery comes out, while the evaluation phase can be performed by teachers and/or students when needed.

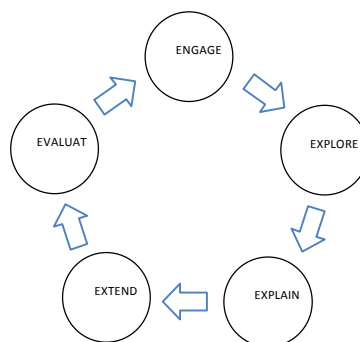

Figure 2. Schematic representation of the 5E's cycle.

During workshop1, it is mostly the trainer who clarifies each step and shows teachers how the 5E's cycle can be implemented. The meaning of the five stages of the cycle is briefly described here below.

- *Engage* is the step during which one gets involved, elicits ideas, and (if teacher) initiates teaching.
- *Explore* is the step during which one plans enquiry and collects observations.
- *Explain* is the step in which one makes sense of data, terminology and theory.

- *Extend* is the step in which one practices and extends the application of concepts, for example one becomes able to recognize the concept when applied in a different context.
- *Evaluate* is the step of the assessment that can be made by problems, questions or different performances both by students and teachers.

4. The role of the mystery in the project

Although the engage phase may take place in a lot of different ways, in the TEMI project it is mainly realized using science mysteries. Following the TEMI approach, a good science mystery for teaching is a science phenomenon that has the following characteristics:

- It is not already understood
- It can be solved in a few hours
- Surprises
- Raises questions
- It's simple enough to not scare students
- Stimulates reasoning
- Helps to develop inquiry skills

In the website of the project (<http://teachingmysteries.eu/it/>) some mysteries are collected, with suggestions related to their practical realization in classroom; and new mysteries are monthly added in order to give teachers more possibilities to fit with their curriculum.

5. Workshop1 Milan – 1st afternoon

Many different approaches are possible for workshop1 and, therefore, also different mysteries can be used to engage teachers and describe them how to solve the mysteries following the 5E's cycle. The risk with this approach is that the emphasis may be given more to the methodology than to the discipline (physics, for us). Therefore, the pilot enquiry lab performed in Milan was carried out with the peculiar aim of taking particular care in giving the same importance both to the physics and to the TEMI methodology. In order to deepen teachers' knowledge and teaching skills in implementing inquiry based lessons, it has been decided to face oscillations and harmonic motion, as they are widely presented school topics. Therefore, all the experiments, realized by the trainers during the first afternoon, engaged teachers with a tracking shot of oscillations, while other examples came from the world outside, through the vision of videos.

The final experiment that has been shown to teachers was the mysterious one: teachers saw a suspended vertical spring with a mass hanged to it. The trainer stretched the spring, and the mass oscillated up and down, as the simple oscillator mass-spring usually does. Then the trainer added another mass to the previous mass, and the oscillations remained of the same kind. But, when the trainer added a third mass, the oscillations changed abruptly: the up and down oscillations gradually turned in pendulum like oscillations which gradually returned to the up and down oscillations, and so on [Boscolo et al, 2013; Mystery of the month, 2014].

Although at first, teachers were not asked to find the solution of the strange behaviour of the mass-spring oscillator (since it presents too many difficulties), they have been very surprised and kept it in mind for many weeks.

Instead, we simply asked teachers, as a first step, to clarify what kind of motion was the usual (up and down) mass-spring motion: was it harmonic or not? We have to stress that, in our pilot inquiry lab, the mystery proposed to engage teachers was not the mystery they had to solve (in opposition of what suggested by the general TEMI scheme). Our choice had been driven by the aim of strongly involving teachers with the idea that even well-known physics (mono-dimensional oscillations) deserves surprises. This is the reason why the previously described intriguing experiment has been shown. Although it is too difficult and discouraging to be solved at the beginning of the training, it is however strongly related with similar and simpler experiment (it suffice to unhook a mass from the mysterious system and the strange behaviour disappears).

The 5E's cycle, started with the engage phase, then continued with the teachers that, divided in groups of three or four, went through the other phases guided by the trainers, behaving like they should ask their own students, if following the TEMI procedures presented. The first afternoon ended when each group finished collecting data, gave the answer, and filled a logbook with ideas and comments to be discussed in the second afternoon of workshop1.



Figure 3. The mass-spring system to be studied in the first afternoon.

6. Workshop1 Milan – 2nd afternoon

The second afternoon session was held a week later. The discussion of the results obtained in the previous afternoon has been discussed group by group. Afterwards, teachers, now a little bit more confident with the enquiry methodology based on the 5E's cycle, were given a new mystery to be solved. The mystery (again about harmonicity) is sketched in Fig.4: A seesaw placed on a flat and another one placed on a round pivot can perform small oscillations around their equilibrium position; are those oscillations harmonic or not?

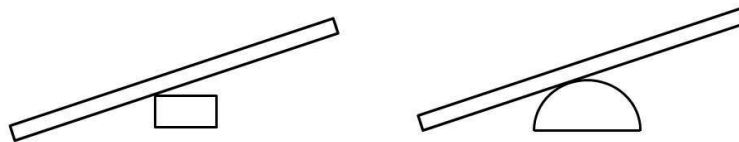

Figure 4. Left, a seesaw on a flat pivot. Right, a seesaw on a round pivot.

In their logbooks, teachers had to collect data, write down plans and comments about their work (as already done in the first afternoon); so to discuss them during subsequent oral interviews, realized again with the groups.

7. Workshop 2

The general structure of the TEMI cohort sessions expects the second workshop to be held 6-8 weeks after workshop1; because the time elapsed should be used by teachers for reflections on what they have learnt. They also have to carry out their first experimentation of the 5E's cycle with their class, and to read research papers (given them by the trainers and related to enquiry teaching) such as [Collins, 1991 and Windschitl, 2007]. In our pilot cohort the time between the two successive workshop has been of 6 weeks.

As represented in Fig.5, workshop2 focuses on two fundamental points: how to the teaching GRR and how to maintain motivation with showmanship. In order to enhance the connections between these two aspects, the unit of Milan explores the use of scientific theatre, in which it has a more than ten year experience [Spettacolo della fisica 2014]. For this reason, one week before the beginning of workshop 2, teachers of the Milan pilot cohort had to watch a physics theatre show. Therefore, during workshop2, teachers that had no prior knowledge of scientific theatre, were also required to learn some basic skills considered essential to make a short dramatization of simple specific physics topics.

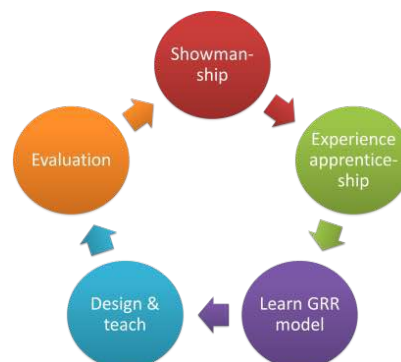

Figure 5. Schematic representation of workshop2 contents.

In this way, they could experience on themselves the process of GRR that they are supposed to teach their students, once in classroom again. In this sense, workshop2 can be considered a practical example of level 2/3 inquiry, also called ‘structured’/ ‘guided’ inquiry.

8. Showmanship innovation and the theatre

The vision of a scientific show is a peculiar part of the Milan approach to TEMI training cohorts. In fact, scientific (or better *physics*) theatre is seen by the Milan partner as extremely intriguing and effective in engaging teachers and students, in eliciting emotional engagement, in maintaining students’ motivation and, very often, it is also a source of mysteries. Moreover it is important to clarify some important aspects of showmanship that is one of the two pillar innovations of workshop2.

Some attention has to be paid to the fact that, although introduced through theatre, showmanship must not be confused with actor skills: it does not always need particular theatrical devices, and teachers need not to be exuberant or mummers. *But* theatre has devised many techniques to improve showmanship and master the art of performance that can be used also by teachers to present in a more effective way their lessons: teachers may think to themselves as directors of their classroom activities. In fact showmanship requires a theatrical grammar that has as roots (at least for what concerns physics teaching) the awareness that:

- The physical message cannot be proposed only in a conceptual way;
- Involvements and meanings come out also from emotional engagement;
- Particular care must be taken in focussing key-points and give suggestions.

More in particular, scientific showmanship demands:

- To present meaningful things in terms of students’ experiences
- To establish conceptual link that help to reduce cognitive difficulties
- To give clear and concise instructions
- To pay attention not only on *what* and *with* to begin with, but also on *how* to start
- To take roles that are different from that of the *standard* teachers, and make student take roles different from those of the *standard* students
- The ability to create disciplinary discussion
- The ability to enhance exploration activities
- The ability to listen to students’ questions without judging them

But, sometimes, also lights, darkness, music and silences can to be used in order to highlight experiments, or parts of them, or to give more meaning to some key sentences. In that way it becomes more likely that students maintain attention and motivation, and a teacher gives them more possibilities to grab new things.

Whatever the personal attitudes, unavoidable for getting a reliable showmanship, is the ability to give personal meanings to scientific topics and to put in evidence large and connected landscapes through which students can move.

9. GRR: gradual release of the responsibility

The GRR model can be well synthesized by the following sentences: “First I do it, then we do it, and finally you do it”, graphically resumed in Fig.6, that is a schematic picture of what may be called “cognitive apprenticeship”, and recalls the time when the boys were apprenticed to learn a trade.

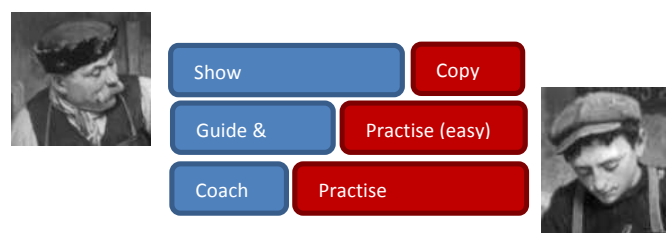

Figure 6. Schematic representation of GRR.

In the TEMI GRR model there are three stages for teaching an enquiry skill:

- At the beginning, the teacher demonstrates or models the skill – and in particular makes the thinking involved explicit and visible. The student basically just copies what the teacher does.
- Then, in a second phase, the student begins to take responsibility. This process can be helped by providing support (a process known as scaffolding) by making the task less complex, by breaking it into stages, or by giving the student only a part of it.
- At the end, the student takes on most of the responsibility, and practises a more challenging version of the task, with less support. The teacher's role is now to coach, providing feedback, and asking questions.

10. Workshop2 Milan – 1st afternoon

During the first afternoon of workshop2 teachers began their familiarization with the concepts of showmanship and GRR.

Since teachers had already seen the show “Let’s throw light on matter” before workshop2, it has been possible to recall them parts of the show to exemplify some key points of the theatrical grammar. The first afternoon has been divided into two parts: a first part in which the trainer explained the TEMI innovations (showmanship and GRR); and a second part in which teachers, divided in groups of 3-4 people, practiced what they have just learnt.

Therefore, each group chose a particular physics topic with the aim of realizing a short theatrical sketch to be presented to the other groups. Their draft sketches were discussed in the final part of the afternoon. Teachers told us that the discussions were necessary to better clarify the following step that they were asked to realize: doing with their students the same kind of work they had just started to appreciate with the trainers. In other words they had to practice GRR in their classrooms, in connection with theatrical grammar: students, divided in groups, would have to choose a topic and realize a sketch and a video that should have been shown to their teachers and classmates. Subsequently, during the second afternoon of workshop2, teachers had to show to the TEMI trainers the videos made by their students and discuss the achievements and difficulties encountered, both by them and by their students.

11. Workshop2 Milan – 2nd afternoon

During the second afternoon a very long discussion took place, as a consequence of the vision of the students' videos. Since the cohort collected teachers of 10th and 11th grades, the topics covered were usually simple and quite common, based for example on refraction, motion in presence of friction and simple oscillations. Although the videos had, in general, no particular or meaningful innovation for the presentation of such common topics, they were anyway realized with genuine engagement and diligence and became also part of the evaluation phase of the pilot lab.

12. Results of the evaluation questionnaire

In the following tables, some of the results of the evaluation questionnaire, that was given to the participants at the end of workshop2, are summarized.

Table 1. Expectation of the participants.

What were your expectations before coming to this training?	
Get new tools/ideas for teaching	64%
Face didactical problems	8%
No answer	28%

Table 2. Gain from the training.

What do you feel you gained from the training? (Multiple choices admitted)	
A new approach to teaching	72%
A motivation to renew my teaching	72%

A better understanding of the inquire based science education	36%
New tools for my teaching	36%
Useful practical examples	14%

Table 3. Overall satisfaction of the participants.

Did the training match your professional needs? (Multiple choices admitted)	
Entirely	71%
Marginally	22%
No answer	7%

Table 4. Best appreciated element of the training.

What element of the training did you like best?	
Explorative work in classroom and in lab, “real didactic”	50%
Knowledge of a new methodology for teaching	22%
No answer	28%

Table 5. Less appreciated element of the training.

What element of the training did you like the least?	
Communication difficulties inside the group	29%
Few time available	13%
No answer	58%

Table 6. Instant feelings.

What do you feel now? (Multiple choices admitted)	
It was worth it	57%
Great fun!	57%
I can improve enthusiasm in my students	38%
I want to experiment the method with my students	29%
Engaging	29%
Skeptical but curious	21%

13. Conclusions

All the 14 teachers of our first cohort have been teaching physics for at least three years in secondary school and were following an in-service teacher training course to get a teaching qualification. They did not choose to follow the inquiry TEMI lab for a particular personal interest, and therefore we believe that they may represent an “average” (not personally motivated) Italian teacher sample for the 10th and the 11th students’ grade, so that the results obtained could probably underestimate the effectiveness of a (voluntary) TEMI inquiry lab in Italy.

Teachers’ disciplinary poor competencies on basic physics (put in evidence by our preliminary written test, not presented here), are a critical point for the realization of a TEMI inquiry lab. In fact, teachers lacking of a satisfactory disciplinary background do not have the necessary awareness of the important conceptual knots that are required to completely appreciate TEMI innovations and, therefore they can probably gain only *one half* of the tools needed to implement IBSE in classrooms. In future trainings we are thus planning a much stronger connection between teachers’ disciplinary preparation and the 5E’s methodology. Nonetheless we want also to point out that teachers of the pilot cohort have certainly learnt a successful methodology (i.e. the use of mysteries to engage students; the 5E’s learning cycle to get the solution of a science mystery and to

build new scientific concept; the possibility of recognize the importance of the showmanship to maintain motivation in a classroom; and the GRR model to gradually encourage students in their conquest of autonomy) that they are also willing to adopt in their lessons. On the contrary, preliminary informal interviews made to much more disciplinary prepared teachers, make us suspect that they would be more reluctant in implementing innovative techniques in their classrooms. It is as if in Italy an *uncertainty principle* (!) between teachers' disciplinary and pedagogical preparation applies, so that, in general, the more they are prepared the less they are open to innovations and vice versa.

Acknowledgements: This work was partially supported by Project TEMI, FP7-Science-in-Society-2012-1, Grant Agreement N. 321403.

References

- Boscolo, I., Castelli, F., Stellato, M. and Vercellati, S. (2013) The parametric spring-mass system, its connection with non-linear optics, and an approach for undergraduate students, arXiv:1402.5318.
- Bybee, R., Taylor, J. A., Gardner, A., Van Scotter, P., Carlson, J., Westbrook, A., Landes, N. (2006). The BSCS 5E Instructional Model: Origins and Effectiveness. Colorado Springs, CO: BSCS.
- Collins, A., Brown, J. S. and Holum, A. (1991). Cognitive apprenticeship: making thinking visible. *American Educator*. <http://www.learnpbl.com/wp-content/uploads/2011/03/Cognitive.pdf>
- Mystery of the month (2014). <http://teachingmysteries.eu/en/mystery-of-the-month/201402/>
- Rocard Report: European Commission (2007). *Science Education NOW: A renewed Pedagogy for the Future of Europe* Luxembourg: Office for Official Publications of the European Commission.
- Spettacolo della fisica (2014). Available at <http://spettacolo.fisica.unimi.it>
- TEMI. European Community's Seventh Framework Programme (FP7/2007-2013) under grant agreement n° 321403 – 2012-1 <http://teachingmysteries.eu>
- Windschitl, M., Thompson, J. and Braaten, M. (2008). Beyond the Scientific Method: Model-Based Inquiry as a New Paradigm of Preference for School Science Investigation. *Science Education*. **92**(5), 941-967.

Affiliation and address information

Marco Giliberti
 UMIL_PERG (University of Milan Physics Education Research Group)
 Department of Physics University of Milano
 Via Celoria, 16
 20133 Milano, Italy
 e-mail: marco.giliberti@unimi.it

Interactive Methodologies in Physics Teacher Training in a Context of Curriculum Innovation: the Peer Instruction Method

Marcelo Alves Barros¹, Marina Valentim Barros²

¹Physics Institute of São Carlos, University of São Paulo, Brazil

²Postgraduate Program in Science Teaching, University of São Paulo, Brazil

Abstract

In general, researches on curriculum innovation in High School Physics have shown the need for a paradigm shift in education, switching from an approach that focuses on the transmission of content to one that actually addresses the needs of students, through interactive methods that aim to alter current classroom dynamics in order not only to promote conceptual learning but also the development of cognitive and social skills. In this work, our goal is to advance the perspective of the professional development of future physics teachers by inserting topics of introductory Quantum Physics in their initial training using an interactive teaching method called Peer Instruction (Mazur, 1997). This work aims to map and evaluate the professional formation of the prospective Physics teachers in Brazil, with emphasis on the teaching methodology proposed and the limits and reach of the teachers' actions after the *Peer Instruction* approach was implemented in their classrooms. Data was collected with a group of 12 preservice teachers on the Physics Teacher Training Course of the São Carlos Institute of Physics, at the University of São Paulo/Brazil. Data analysis focused on the professional development of future teachers regarding their approach on sharing contents and meanings in classrooms. The research provided insights on understanding the role of teacher-learner interactions, indicating the change in speech of future teachers. The results have also shown that the *Peer Instruction* method may be an efficient tool on preparing future teachers and enabling them to deal with methodological aspects in a context of curricular innovation, aiming to actively engage students in their own learning process. We hope to contribute to the advances on researches on the teachers training courses in a context of curriculum innovation, expanding our interpretation of the mechanisms and processes involved in the initial training of Physics teachers whenever they work with interactive teaching methodologies, in particular, the *Peer Instruction* method.

Keywords

Peer Instruction, teaching quantum mechanics, interactive methodologies, and teacher training.

1. Introduction

Research into curriculum innovation in Physics in the High School has focused on the need to shift from a paradigm-centered education in the transmission of content, to one that emphasizes the needs of students through interactive methodologies that aim to change the current dynamics of the classroom in order to promote both conceptual learning as well as the development of cognitive and social skills of communication and argumentation. Despite these advances in research, education based on the transmission of content has resisted change, largely due to teachers' knowledge and their beliefs about the nature of their disciplines as well as their personal and professional identities in the teaching and learning of specific content (Davis, 2003). In other words, the way in which teachers learn certain content, and learn to teach what they know and are able to pass it on to students are factors that need to be better understood during the process of curriculum innovation in the classroom (Couso, 2009; Pintò, 2005).

The following work presents a description and an analysis of the declared strategies that were part of a short course on topics of Quantum Mechanics for the High School taught by 12 prospective undergraduate teachers on the Exact Sciences Physics Course, at the USP Institute of Physics in São Carlos, all grant-holders on the Initiation to Teaching Scholarship Program (PIBID/CAPES) in 2013. The analysis was undertaken using the analytical tool proposed by Mortimer et al (2007). This analysis takes into account not only verbal language, but a set of modes of communication that are described in detail below. The group of prospective teachers prepared a teaching and learning sequence on topics of quantum mechanics using the

Peer-Instruction methodology (Mazur, 1997). The learning sequence was implemented in a short 8-hour course for students in the public school system, centered on the following topics: Mach-Zehnder interferometer; the double-slit experiment and the photoelectric effect. Student teachers used in their preparation of the short course a support text for Physics Teachers from the UFRGS entitled "Introducing quantum mechanics in the High School: a proposal for teachers" written by Márcia Cândido Montano Webber and Trieste Freire Ricci (Webber & Ricci, 2006) and implemented the exploratory activities in the text's proposed script and used the Doppelspalt open source software package. In addition to these activities, the group of teachers participating in the PIBID/CAPES project had weekly meetings with a supervising teacher at the University to discuss content, methodological issues and planning the learning sequence, devoting a period of 8 hours per week for the project over the course of one year. The research objective was to advance the professional development of prospective Physics teachers through the inclusion of topics of Modern and Contemporary Physics in their initial training, using an interactive teaching methodology, Peer Instruction (Mazur, 1997). The interest of this work is to map and evaluate the training of prospective teachers of Physics in Brazil with emphasis on: i) the proposed teaching methodology, and ii) the limitations and scope of teaching activity based on the implementation of the Peer Instruction method in the classroom.

2. The Peer Instruction Methodology

The short course on topics of Quantum Mechanics was structured using the Peer Instruction methodology and presents a proposal that aims to transform the learning environment and actively engage students. The main objective of peer instruction is to promote the learning of the fundamentals of Physics by discussing conceptual issues and creating engagement among students. Instead of merely watching the teacher impart information, based on this method, classes are structured in small presentations of key concepts followed by conceptual tests for students to respond to individually before discussing the concepts with colleagues. Instead of the teacher presenting the subject with the level of detail of a textbook or lecture notes, classes based on this method consist of a number of short presentations containing key content, followed by conceptual tests on the subject presented that will subsequently be discussed among students (Mazur, 2012). *Peer Instruction is flexible and easy to use on its own or in conjunction with other teaching methods* ". (Rosenberg, Lorenzo & Mazur, 2006, p.77).

The class based on the peer instruction methodology initially has a brief oral presentation by the teacher, followed by a conceptual multiple choice test usually to be answered by students individually using clickers (electronic devices in which the student makes the choice of alternative he judges to be correct). After the initial individual response, students discuss the concept among their peers and a second vote is held, followed by the closing remarks of the teacher, as outlined in Table 1 below.

Table 1. Scheme of the application of the Peer Instruction method (Crouch, Watkins, Fagen, & Mazur, 2007,p.6-7).

1. Question posed 1 minute
2. Students given time to think 1- 2 minutes
3. Students record/report individual answers
4. Neighboring students discuss their answers 2- 4 minutes
5. Students record/report revised answers
6. Feedback to teacher: Tally of answers
7. Explanation of correct answer 2 minutes or more

3. The analysis structure

In this paper we present an analysis and characterization of the discourse of a prospective teacher of Physics during an episode taken from the short course on topics of Quantum Mechanics for the High School. We outline the discursive and interactive movements of the prospective teacher using the category system proposed by (Mortimer et al., 2007). We chose these categories since our methodology (peer instruction) favors interactivity between teachers and students. The categories used in this work are: patterns of discourse interaction; the kinds of communicative approach used by the teacher, and the intentions and forms of teacher intervention.

The interaction patterns refer to modes of speech between teacher and students and how they alternate these dialogues. Mortimer & Scott (2003) define as the most common sequence of interaction what is termed I-R-E (Teacher Initiation, Student Response, Teacher Evaluation), which takes into account the Teacher-Student-Teacher Interaction. First the teacher asks the student a question (I), then the teacher awaits the student's response (R) and to close the sequence the student is evaluated by the teacher (E), a so-called triadic sequence. Another triadic pattern of discourse is the I-R-F in which the teacher, instead of evaluating the pupil's response, pupil gives him feedback, which aids the student in developing his point of view.

The communicative approach is the way in which the teacher works with students to address the different ideas that appear during a science lesson (Mortimer & Scott, 2003, p.469). There are four classes of communicative approach identified that are characterized based on the dialogue between teachers and students and can be defined in terms of two dimensions: either the dialogic or the authoritative dimension, that is, either an interactive or a non-interactive dimension (Mortimer & Scott, 2003). The dialogic dimension is characterized by the teacher's dialogue with students in which multiple points of view are shared, the teacher introduces new ideas and listens as students work with them, how they organize the information and ideas in different patterns (Mercer & Hodgkinson, 2008). In the authoritative dimension there is only one point of view, that of the teacher: the ideas of the students are not explored. Interactive or non-interactive dimensions are related to student participation or non-participation. Combining these dimensions there are four classes of communication approach, as illustrated in Table 2 below.

Table 2. Classification of communicative approach.

Dimension	Interactive	Non Interactive
Dialogic	Interactive/Dialogic	Non Interactive/Dialogic
Authoritative	Interactive/ Authoritative	Non Interactive / Authoritative

The intentions of the teacher correspond to aims that are present at the time the script is prepared and activities are selected, and thus will determine, to some extent, their performance in the social plane of the classroom (Silva, 2008, p.76). The intentions of the teachers in the classroom are identified by (Mortimer & Scott, 2003) and are summarized in Table 3 below.

The aspect of the tool of analysis of (Mortimer & Scott, 2003) called teacher's interventions relates to the manner in which the teacher intervenes in the development of the scientific story narrated in a science class. There are six ways to make this intervention already identified by research and outlined in Table 4 below.

Table 3. Teaching purpose (Mortimer & Scott, 2003).

Teacher purpose	Focus
Opening up the problem.	Engaging students intellectually, and emotionally, in the initial development of the scientific story.
Exploring and working on students views. Introducing and developing the scientific story.	Probing students 'views and understanding of specific ideas and phenomena. Making the scientific meanings (including conceptual, epistemological, technological, social and environmental themes) available on the social plane of the classroom.
Guiding students to work with scientific meanings, and supporting internalization.	Providing opportunities for students to talk and think with new scientific meanings, individually, in groups or in whole-class situations. At the same time, supporting students in making individual sense of, internalizing and those meanings.
Guiding students to apply, and expand on the use of, the scientific view, and handing over responsibility for its use.	Supporting students in applying taught scientific meanings in a range of contexts and handing over responsibility for using those meanings to the students.
Maintaining the development of the scientific story.	Providing commentary on the unfolding scientific story, to help students to follow its development and to see how it fits into wider science curriculum.

Table 4. Teaching intervention (Mortimer & Scott, 2003)

Teacher Intervention	Focus	Action the teacher might take
1- Shaping ideas	Working on ideas, developing the scientific story	Introduce a new term; paraphrase a student's response; differentiate between ideas
2- Selecting ideas	Working on ideas, developing the scientific story	Focus attention on a particular student response; overlook a student response
3- Marking key ideas	Working on ideas, developing the scientific story	Repeat an idea; ask a student to repeat an idea; enact a confirmatory exchange with a student; use a particular intonation of voice
4- Sharing ideas	Making ideas available to all the students in a class	Share individual student ideas with the whole class; ask a student to repeat an idea to the class; share group findings; ask students to prepare posters summarizing their views.
5-Checking student understanding	Probing specific student meaning	Ask for clarification of students ideas; ask students to write down an explanation; check consensus in the class about certain ideas
6- Reviewing	Returning to and going over ideas	Summarize the findings from a particular experiment; recap on the activities of the previous lesson; review progress with the scientific story so far

4. The teaching episode

The teaching episode selected corresponds to a proposed short course on the double-slit test, which asked whether interference is a phenomenon belonging to the quantum, to the classical or to both worlds (Table 5). The question is presented to students after reading an excerpt from the book *Alice in Quantumland* (Gilmore, 1998), which was given to students in a handout format. Prospective teacher Daniela, in the light of the individual students' responses, verifies that a discussion of the issue is necessary, since no more than 70% of student answers were correct (Lasry, Mazur, & Watkins, 2008).

Table 5. Question on the phenomenon of interference

Classify whether the <u>Phenomenon of Interference</u> exhibits characteristics belonging to the classical world, the quantum world or both worlds: a) classical world b) quantum world c) classical and quantum world

The reason for the choice of the presentation of this episode in this paper is because it deals with a critical issue for understanding the quantum world: that interference can occur both in the classical world and in the quantum world. This conceptual test was presented prior to the double-slit and the Mach-Zehnder interferometer experiments, and it was essential for the student to know that interference is also a quantum phenomenon. The fact that the interference phenomenon belongs to the classical and quantum world and that it occurs in waves, photons and electrons is an oddity for the student who is beginning the study of quantum Physics. Understanding the nature of wave-particle duality is fundamental to the understanding of the quantum world and its peculiarities (Feynman, Leighton, & Sands, 1969). Another reason for choosing this episode over others is the intense participation of students and the variety of arguments presented by them on the characteristics of both worlds. We chose to present only one episode due to the paper's limitations of space.

At the beginning of the episode the student teacher asks the students to begin the discussion by presenting arguments that justify their choice and confronting their choice with that of their peers. The teacher's role at this time is to stimulate discussion among students and make them organize their ideas, to understand why they chose a certain alternative and to create arguments to defend their choices. Students 1, 2 and 3 chose in the first vote the correct answer to the question, namely that interference occur both in the classical world and in the quantum world. However, when students are questioned by the prospective teacher about what they understand about the concept of interference, she then realizes that this concept was not clear to them,

even though they had chosen the correct answer. Daniela says that students did not understand the text that had been read, since they could not explain what interference was.

1 **Daniela:** Why did you put the letter C here? [the prospective teacher addresses the students closest to her]

2 **Student 1:** I put the letter C because...interference can happen in the classical world and the quantum world because, sort of, you know, the right atoms with the quantum world, isn't it? It's...the thing.. [student 1 addresses Daniela]

3 **Student 2:** both...right...interference...yes [student 2 addresses Daniela]

4 **Student 1:** It's because you have interference in both

5 **Daniela:** What is interference? Can you tell me what it is?

6 **Student 1:** Oh no, I'm getting confused

7 **Student 3:** which classifies the property of waves

8 **Student 1:** It talks about waves [student picks up the hand-out and looks for the place in the text]

9 **Daniela:** In the book it says, right

10 **Student 1:** it's [still looking for the part in the handout regarding the text]

11 **Student 2:** ...here it says...right

12 **Daniela:** then you didn't understand the reading...everyone here put the letter C...you people are really smart

13 **Student 1:** lucky [laughing]

14 **Daniela:** The question I asked...can you tell me what interference is?

15 **Student 1:** interference occurs in waves

16 **Daniela:** ...it occurs in waves...but what is it?

17 **Student 1:** It's when a wave collides with another wave [the student makes a gesture interlacing the fingers]

18 **Daniela:** It's when we have a superposition of waves, right? Can you tell me why it can happen in the classical world and the quantum world?

19 **Student 1:** Because there are waves in the classical world and in the quantum world! [Students and Daniela laugh at the answer given by the student 1.]

In this excerpt of the episode Daniela develops an interactive dialogic communicative approach with the students and tries to ascertain what they understand about the phenomenon of interference, and why they chose the answer that the phenomenon of interference belongs to both worlds. She makes interventions aimed at verifying the students' understanding of the phenomenon of interference through questions such as: "*the question I asked is can you tell me what interference is?*"; "*it occurs in waves...but what is it?*" "*Can you tell me why it can happen in the classical world and in the quantum world*". From turn 14-19 there is an open chain pattern of discourse of the I-R-F-I-R-F-I-R type, in which Daniela begins with an initiation in turn 14 and receives answers from students about what they understand by interference, such as the reply in turn 19 that "*there are waves in the classical world and in the quantum world.*" In turn 16 the prospective teacher repeats a phrase spoken by student 1, that interference "*occurs in waves*" in order to emphasize this idea. In turn 16 Daniela repeats the idea of student 1 that "*it is when a wave collides with another*" although she uses a scientific term "it is when a superposition of waves occurs, right?" helping the students to deal with Physics concepts.

Following this sequence Daniela makes an authoritative intervention modifying the focus of the conversation on what is interference, she asks the students about the differences between the two worlds and why waves are present in the classical and quantum world. In turn 24 the prospective teacher introduces a new issue, the measurement of the trajectory of a classical particle, which is different in the quantum world. Student 2, in turn 28, gives a correct answer to the question of the location of the particle in the quantum world; "no, it can go anywhere, we can't know for sure where."

20 **Daniela:** Ok...if we were...you understood the text you read, if we were to measure the differences between the classical world and the quantum world, right? Thinking about the differences between the two worlds, can you tell me why waves are present in the classical world and the quantum world?

- 21 **Student 2:** Ahhh because in the classical world the waves would have a correct direction like this [makes a gesture with his hand]
 22 **Bruna:** [the class teacher]: Ok
 23 **Student 1:** NO, I think it's because in the classical world the waves are like water waves and so on, and in the quantum world and I think it's waves...electromagnetic waves, sound waves and so on.
 24 **Daniela:** Well then, let's just think like this...in our classical world we have a particle and we can measure the specific trajectory of that particle, right? Only if this particle is a wave, we can measure the specific trajectory of a wave there
 25 **Student 2:** I think so
 26 **Student 1:** What?
 27 **Daniela:** Oh so just think in the classical world we have a particle and we can measure the specific position of that particle, right...we know exactly the linear momentum of this particle, where it is, its position...and now this particle behaves like a wave...do we know how to measure...do we know exactly where it is...? Think of a wave
 28 **Student 2:** No it can go anywhere, we're not going to know exactly where
 29 **Daniela:** Exactly, so for this...you saw the end of the chapter, we're left with this wave-particle duality...you'll see that a particle behaves like a wave.... I'll explain it better for you, ok?
 30 **Student 1:** Uh huh

In this part of the episode (turns 20-30) Daniela adopts an interactive authoritative approach, as she introduces new concepts such as measurement of trajectory and the wave-particle character, asking the students questions and evaluating their responses. We have in this part the presence of a speech pattern of the I-R-E type (turn 27-29) with an initiation by the teacher (turn 27), the response of student 2, and Daniela's evaluation in turn 29.

From this moment (turn 30) the prospective teacher draws the discussion to a close at the front of the classroom with a non-interactive authoritative speech telling the students that the interference phenomenon belongs to both worlds and that the correct answer was alternative C. In turn 33 Daniela makes an initiation asking students if they can discover the path of the particle if it behaves like a wave. Student 1 gives the answer aloud to the whole class; the same student who had shown not to have understood this issue of the trajectory in the group discussion (turn 26).

- 31 **Daniela:** Well class...let's see...can someone tell me the answer to this question?
 32 **Student 1:** Matheus knows [student 1 referring to fellow student 2]
 33 **Daniela:** The correct answer to this question would be the letter C, right? [Laughter of all students]. So, interference...it's a phenomenon that happens in the classical world and the quantum world, right? And...the answer and the final point...the answer to that question will be something...which we're going to get into now, ok? If we were thinking of the classical world and the quantum world, well just as we had commented on a particle in the other questions, a particle is going to have a trajectory in the classical world and a linear momentum which is quite specific, isn't that so? And now if this particle behaves like a wave is it possible to know? Can we know?
 37 **Student 1:** No
 38 **Daniela:** Can we know where its specific momentum is...well now I'm going to call on Tamara and she'll introduce a very cool thing for you and then we'll continue these activities.

The main points of this episode are summarized in Table 5 below.

Table 5. Episode summary

Teacher's Intentions	<ul style="list-style-type: none"> • Explore students' ideas about interference. • Engage students in understanding the question about interference occurring in both worlds. • Develop the scientific story that a particle can behave like a wave and that interference is a phenomenon belonging to both worlds.
Content	To classify whether interference is a phenomenon of the classical world, of the

		quantum world or of both worlds.
Communicative Approach		Interactive/ dialogic at the start of the episode. Interactive/ authoritative in the middle of the episode. Not interactive authoritative in the closing stage of the episode.
Patterns of Interaction	of	I-R-F-I-R-F-I-R (open chain) I-R-E
Forms of Intervention	of	<ul style="list-style-type: none"> • Verified the students' understanding through questions about what is interference. • Repeated the explanations of the students during the dialogue with the aim of highlighting certain important scientific content. • Paraphrased the responses of students in order to shape ideas about the phenomenon of interference. • Helped to identify portions of the book with the concepts of interference seeking clarification on the ideas of the students.

5. Conclusions

The prospective teacher alternates between an interactive dialogic communicative approach presenting an open chain pattern of speech and an authoritative communicative approach presenting a closed chain pattern of speech. She had an interactive dialogic communicative approach when she wants to discover what the student thinks about his answer and when she wants to face up the students answers, which occurs while assisting peer instruction. The authoritative communicative approach appears when the prospective teacher introduce new concepts such as measurement of trajectory and the wave-particle character and when she give the right answer aloud to the whole class. Our analysis structure shows the variation between these two classes of communicative approach, which meets different moments in a peer instruction classroom. These varying classes of communicative approach are also common in didactic sequences that involve abstractions in which the teacher wants to introduce scientific views on the content studied (Mortimer & Scott, 2003). In this paper we seek to contribute to advances in research into teacher education in a context of curriculum innovation, broadening our understanding of the mechanisms and processes involved in the initial training of Physics teachers when they work with interactive teaching methodologies, in particular, the Peer Instruction method.

References

- Couso, D. (2009). *Science Teachers ' Professional Development in Contexts of Educational Innovation Analysis of three initiatives*. Universitat Autònoma de Barcelona.
- Crouch, C. H., Watkins, J., Fagen, A. P., & Mazur, E. (2007). Peer Instruction : Engaging Students One-on-One , All At Once Abstract: *Research-Based Reform of University Physics*, (1), 1–55. Retrieved from <<http://www.per-central.org/document/ServeFile.cfm?ID=4990>>
- Davis, K. S. (2003). “Change is hard”: What science teachers are telling us about reform and teacher learning of innovative practices. *Science Education*, 87(1), 3–30. Retrieved from <http://doi.wiley.com/10.1002/sce.10037>
- Feynman, R. P., Leighton, R. B., & Sands, M. (1969). *Lectures on Physics*. (California, Ed.) (Volume 3.). Addison-Wesley Publishing Company.
- Gillmore, R. (1998). *Alice no País do Quantum* (p. 192). Rio de Janeiro: Jorge Zahar.
- Lasry, N., Mazur, E., & Watkins, J. (2008). Peer instruction: From Harvard to the two-year college. *American Journal of Physics*, 76(11), 1–17. doi:10.1119/1.2978182
- Mazur, E. (1997). *Peer Instruction A User's Manual* (p. 253). Saddle River, NJ: Prentice Hall.
- Mazur, E. (2012). Confessions of a converted lecturer. Estados Unidos: UNIL, Lausanne: UnilTV. Retrieved from <http://www.youtube.com/watch?v=ZpNjem3p0Ak> >.
- Mercer, N., & Hodgkinson, S. (2008). *Exploring talk in schools*. (N. Mercer & S. Hodgkinson, Eds.) (Segunda., p. 207). London: Sage.

Mortimer, E. F., Massicame, T., Tiberghien, A., & Buty, C. (2007). Uma metodologia para caracterizar gêneros de discurso como tipos de estratégias enunciativas nas aulas de ciências. In *A pesquisa em ensino de ciências no Brasil* (2007th ed., pp. 1–27). São Paulo: Escrituras.

Mortimer, E. F., & Scott, P. H. (2003). *Meaning making in secondary science classrooms* (p. 199). Philadelphia: Maidenhead: Open University Press.

Pintò, R. (2005). Introducing curriculum innovations in science: Identifying teachers' transformations and the design of related teacher education. *Science Education*, 89(1), 1–12. doi:10.1002/sce.20039

Rosenberg, J. L., Lorenzo, M., & Mazur, E. (2006). Peer Instruction : Making Science Engaging. In J. Leonard, J. Mintzes, & H. Willian (Eds.), *Handbook of College Science Teaching* (pp. 77–85). Arlington: NSTA Press.

Silva, A. da C. T. (2008). *Estratégias Enunciativas Em Salas de aula de Química : Contrastando professores de estilos diferentes. Tese (Doutorado em educação)*. Universidade Federal de Minas Gerais, Belo Horizonte.

Webber, M. C. M., & Ricci, T. F. (2006). Inserção de Mecânica Quântica no Ensino Médio : Uma Proposta para Professores. Programa de Pós- Graduação em Ensino de Física Mestrado Profissional em Ensino de Física.

Affiliation and address information

Marcelo Alves Barros

Instituto de Física de São Carlos

Av. Trabalhador São-Carlense, 400 - Pq. Arnold Schimidt

CEP: 13566-590 - São Carlos - SP - Brasil

e-mail: mbarros@ifsc.usp.br

Marina Valentim Barros

Universidade de São Paulo

Av. Prof. Almeida Prado, nº1280 - Butantã

CEP: 05508-070- São Paulo - SP-Brasil

e-mail: marina.valentim@usp.br

How Experimental Resources in Physics Teaching facilitate Conceptual Learning?

Carlos Buitrago, Maria Maite Andrés

Universidad Pedagógica Experimental Libertador-Instituto Pedagógico de Caracas Dpto. Matemática y Física. Venezuela

Abstract

In the physics teaching, frequently we use the discourse of the teacher and the solution of exercises as the main didactics resources. In most students, this does not seem to promote the construction of knowledge about the science and its nature. Following the proposal of the critical meaningful learning of Moreira, the application of the theory of conceptual fields of Vergnaud and the epistemological approaches derived from a non-standard view about science, we then asked: The intentional integration of traditional resources with the experimental resources, in one sequence of situations-problem of physics that put the student in cognitive action, will promote the conceptual learning? We have organized a sequence of didactic situations centred in problems, which refer to the situations regarding of the conceptual field that we have constructed from the physics. We incorporated to the traditional resources, three experimental resources (demonstration, simulation, experimental data) in a complementary manner and intentional. We assayed this proposal in action research with a group of student-teacher in training during a course of Fundamentals of Physics, for learning concepts about kinematics; which lasted six weeks, with two classes of three hours each per week. The students worked in cognitive and practice action while the teacher mediated the learning process guided by the model learning of the physics laboratory work (MLPLaW). The student's learning outcomes in action were collected through: initial and final tests, observation of teacher researcher and working guide delivered to them. Among the most relevant results, we have found that students in the final test were able to recognize many of the situations we presented them, identify goals and make anticipations and be able to account for new or modified cognitive elements (compared to the initial test) which we assume were developed during teaching. Also, the student was willing to participate and monitor their learning process. They qualified as positive the incorporation of experimental resources in the process of their active construction of meanings, and became aware of the theory experiment-model relationship. This work confirms that the establishment of the field conceptual in terms of situations, concepts and representations is a suitable tool for the organization of teaching and assessing the progressivity of meaningful learning of concepts; as well as the integration of theory and experiment in physics teaching would promote learning and the understanding of the nature of science.

Keywords

High School Teacher Education. Theory-Experiment. Teaching Strategies. Meaningful Conceptual Learning.

1. Introduction

Discourse of the teacher and solution of exercises does not seem to promote the construction of knowledge about the science and its nature. Considering the need for a conceptual development that approximates the conceptual structure of science and an integrated view between theory and phenomenon, we proposed the following question:

Put student in cognitive and practical action at a sequence of situation-problem of physics, where traditional resources are integrated to experimental resources that complement (demonstration, virtual simulation and experimental data), will promote the conceptual learning?

From the theory of conceptual fields of Vergnaud (2007) the learning of concepts is considered like a progressive development. Furthermore, a concept is an indissoluble triad: situation (sense), invariants operative (meaning) and representations (referents), which is part of the schemes that activate when the

person approaches a task. The students activate their schemes to solve problems; to the extent that the situations that we present are new (which can be resolved), we can *mediate* the incorporation of new concepts to their schemes (Figure 1).

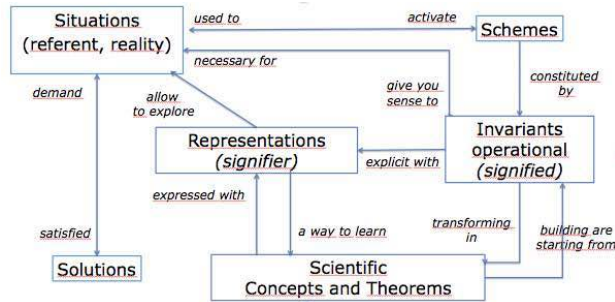

Figure 1. Cognitive dynamic in solving problems.

To achieve this mediation, we have organized a sequence of didactic tasks, which refer to the situations regarding of the conceptual field (CF) that we have constructed from the physics, and that set out a complex conceptual hierarchy (Figure 1; Table 1).

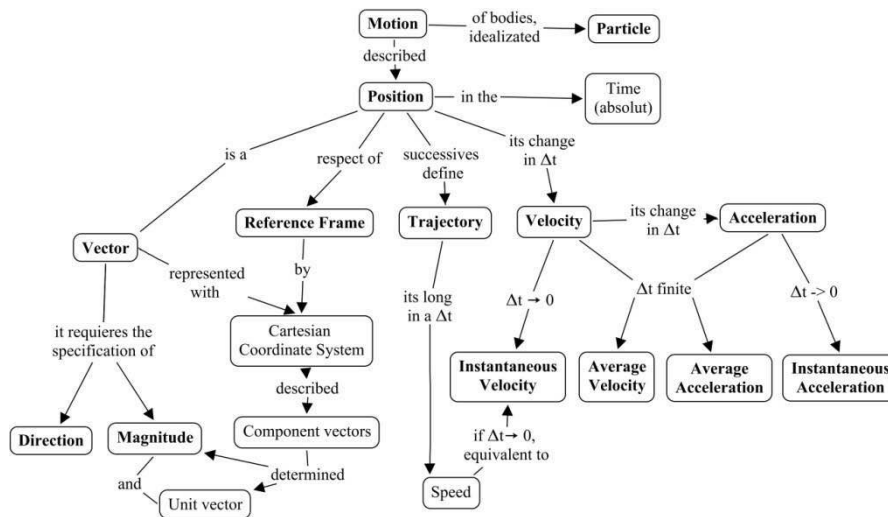
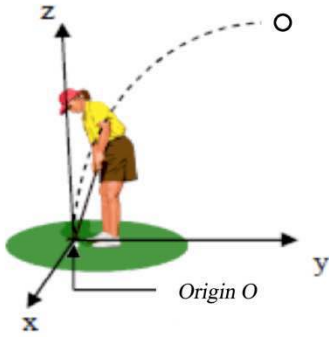
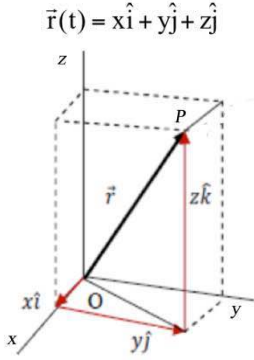
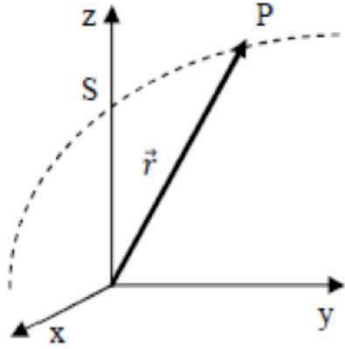
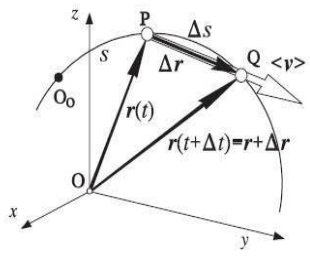

Figure 2. Comprehensive set of concepts and interrelationships of the conceptual field (kinematic).

Table 1. Set of situations and representations of the conceptual field (CF) for kinematic (S1 to S8).

Situation	Representations	Situation	Representations
<p>S1</p> <p>Formal representation of a vector and addition</p>		<p>S2</p> <p>Describe the vector position by using a Cartesian coordinates system</p>	$\vec{A}(t) = \vec{A}_x \hat{i} + \vec{A}_y \hat{j} + \vec{A}_z \hat{k}$

Situation	Representations	Situation	Representations
S3 Setting a reference frame		S4 Determine the position of a particle and its evolution in time	$\vec{r}(t) = x\hat{i} + y\hat{j} + z\hat{k}$ 
S5 Describe the trajectory		S6 Determine velocity and speed of the particle.	Velocity: Average Instantaneous $\vec{v}(t) = \frac{\Delta \vec{r}}{\Delta t}$ $\vec{v}(t) = \lim_{\Delta t \rightarrow 0} \frac{\Delta \vec{r}}{\Delta t}$ Speed $v = \frac{\Delta s}{\Delta t}$ 
S7 Determine acceleration of the particle	Acceleration: Average, instantaneous Graphics representations and $\vec{a}(t) = \frac{\Delta \vec{v}}{\Delta t}$ $\vec{a}(t) = \lim_{\Delta t \rightarrow 0} \frac{\Delta \vec{v}}{\Delta t}$	S8 Describe motion of the particle	Graphs-relations $\vec{r}(t)$ $\vec{v}(t)$ $\vec{a}(t)$

Following the proposal of the critical meaningful learning of Moreira (2006), in the teaching process we integrated traditional resources (lecture and exercises or paper and pencil) with three experimental resources: demonstrations, simulations and experimental data. This combination would promote the theory-experiment relationship (Andrés et al, 2007). We established didactic intentions potential for each experimental resource (Buitrago, 2012) (see Table 2).

Table 2. Didactic intentions potential of experimental resources.

Resources	Didactic intentions potential
Demonstration	<ul style="list-style-type: none"> • Get involved in a direct way with the phenomenon • Connect the theories underlying physical with the physical situations presented and everyday life • Involved in the development of explanations and critical discussion.
Virtual Simulation	<ul style="list-style-type: none"> • Operate with the model and the implicit relations through variety of recreated phenomena • Interact with the various representations of the concept
Experimental data	<ul style="list-style-type: none"> • Establish a logical connection between the variables that make up the structure of the concept and the actual physical situation developed

- | | |
|--|---|
| | <ul style="list-style-type: none"> • Build bridges between experimental data and theoretical data obtained (calculated). • Show the validity and usefulness of the concepts in the interpretation and representation of the physical world. |
|--|---|

Accordingly, we organized a potentially meaningful teaching sequence for the mediation of the situations that integrated theory and phenomena, in accordance with model learning of the physics laboratory work (MLPLaW) (Andrés, 2007). Interaction with peer, and didactic tasks, were oriented with worksheets. Below we describe the sequence of lessons:

- Lesson 1. Situation 1. Use two *Simulations*: 1. "Force in one and two dimensions" and 2. "Motion 2D". (<http://phet.colorado.edu>) associated with concrete physical situations, both in the straight line as in the plane, in order to give physical meaning to this mathematical object. Interaction with the simulations was planned.
- Lesson 3. Situation 3. Use two *Demonstrations*: 1. "Model a reference frame in three dimensions for the use of maps", we use the world map projected on blackboard, we take it as a inertial frame of reference in plane in order to the students make a vector representation of their position, for example from their country to one country home in Africa. 2. "Describe position of a book on the desk", we select a corner of the room like a representation of a Cartesian coordinate system of the space, the students measured the coordinates of the position vector.
- Lesson 4. Situation 4. We present one *Simulation*: "Projectile Motion" (<http://phet.colorado.edu>) to study the trajectory described by a projectile and the temporal dependence of its coordinates with respect to time, in graphical and symbolic mathematics forms; and *Experimental Data*¹ of position and time of motion of a sphere in two dimensions (XY) from video, which are represented in tables and graphics. In this case, we contrast the model with results of experiment.
- Lesson 5. Situation 5. In the classroom also we contrast the model results with of the experiment, first worked with one *Demonstration*: A tiny ball of lead moving in transparent hose inside. This assembly was on the table supported with universal brackets, showing an irregular trajectory. Students watched the path of the sphere from established the XY, XZ and YZ planes. Finally, interaction with one *Simulation*: "Motion in 2D" (<http://phet.colorado.edu>).
- In the remaining Lessons for Situations 6, 7 and 8, we worked with data and graphics obtained with Logger Pro software, from motion of various objects. In each session of analysis the data and the graphics, the meanings and representations of new concepts and relations were synthesized.

2. Methodology

This potentially meaningful teaching sequence was essay an action research where we worked with a group of Biology students in teaching training during a course of Fundamentals of Physics (F: 5 and M: 2), with kinematic's concepts. The testing lasted six weeks, two lessons of three hours each per week (Regular period: 16 weeks). The group worked in cognitive and practical action, using worksheets that guided their action during the didactic tasks. The teacher mediated the learning process with questions, orientations, suggestions and explanations, guided for the MLPLaW.

The student's learning outcomes regarding to the situations of CF, were collected of three forms:

- i) Initial and final tests, these included twelve physics problems (Annex two items) that correspond to the conceptual field situations, or set situations (Table 1). The final test included more questions about CF in similar items to initial test.
- ii) Observation of teacher researcher.
- iii) Worksheets delivered to the students at the end of each didactic situation as homework containing questions and problems.

3. Results

The written productions in tests and worksheets were categorized in attention to concepts and relationships expressed that is, meanings and representations (see legend of Table 3), with reference to the CF (Table 1). In *the initial test*, we found that students did not explicit any graphics, iconic and symbolic mathematical representations, nor perform calculations for obtaining the relations among the vector magnitudes: change of

¹ VideoPoint™ (v.2.5) Lenox Software Lenox, MA.01240, © 2001, license of Maite Andrés.

position, average velocity, instantaneous velocity, nor the scalars: distance or path length, average speed. Thus was established that, at the beginning, students had little comprehension (or none) of the meanings and of relational and geometric representation of the concepts associated to problems of the situations (Table 3). These results did not surprise, the students were from the area of Biology.

Table 3. Results of the students in the initial test.

Items / (Situation)	lin	zur	jon	hec	yul	kem	pab
1 - 2 / Formal representation of a vector and addition	1.1	NA	1.1	NA	1.1	NA	NA
3 - 4 / Describe the vector position	2	2	2	2	NA	NA	NA
5 - 6 / Determine the position of a particle and its evolution in time and trajectory	1.2	1.2	1.2	NA	NA	1.2	NA
7 - 8 / Determine the position of a particle and its evolution in time and trajectory	4	4	4	4	4	4	4
9 - 10 / Determine velocity and speed of the particle, graphics	4	4	4	4	4	NA	NA
11 - 12 / Describe motion of the particle, graphics	4	4	4	4	4	4	4

(1) Used all forms of representations of CF. (1.1) Only represented by graphs. (1.2) Only represents iconic form.

(2) Use the informal language.

(3) Used relations of CF. (3.1) Use some formal relations of CF.

(4) Did not use relations appropriated of CF o use informal relations.

(5) Use representations non appropriated

(6) Appropriated calculations

(NA) No answer

During teaching, to the end the didactic work with each situation of the CF, students solving problems outside of classroom that delivered in the next session. Below, a summary of the results in these homeworks:

- Most students associated the relevant concepts to the problems in each task. We observed difficulties in differentiating the concepts of average and instantaneous velocity.
- They showed the use of different representations: graphic, iconic and symbolic mathematics (algebraic); and also showed greater difficulties in vector representations.
- They exposed adequate algebraic expressions (from CF) associated with the concepts to various problems of each class of situations in the respective task; also they made appropriate physical interpretations thereof. However, when they were performing algebraic operations to obtain quantitative results, they showed difficulties when using some mathematical transformations.
- They were able to relate algebraic expressions associated to the concepts, with the symbolic representations of the underlying models for each situation.

In the *final test* (Table 4), we found that most students showed systematic and appropriate use of concepts through representations and the corresponding mathematical relationships, approaching the CF. Underlines that in the items 11-12, whose conceptual complexity was higher, 3 students responded well, while 4 students not respond some questions. Comparing with the results in initial test we can consider that the students achieved progress in the conceptual development, because in their initial responses prevailed the informal language, while it after the didactic sequence they responded in terms of the concepts of CF.

Table 4. Results of the students in the final test.

Students→ Items / (Situation)	lin	zur	jon	hec	yul	kem	pab
1 - 2 / Formal representation of a vector and addition	1	1	1	1	1	1	1
3 - 4 / Describe the vector position	3	3	3	3	3	3	4
5 - 6 / Determine the position of a particle and its evolution in time and trajectory	1	1	1	5	1	1	1
	1	1	1	NA	1	1	1

Students→ Items / (Situation)	lin	zur	jon	hec	yul	kem	pab
7 - 8 / Determine the position of a particle and its evolution in time and trajectory	3	3	3	3	3	3	5
9 - 10 / Determine velocity and speed of the particle, graphics and operational	1 6	1 6	1 6	1 6	1 6	1 6	1 6
11 - 12 / Describe motion of the particle, graphics and operational	1 1 1	1 1 1	1 1 NA	1 1 1	1 1 NA	NA 1 1	1 NA 1

(1) Used all forms of representations of CF. (1.1) Only represents by graphs. (1.2) Only represents iconic form.

(2) Use the informal language.

(3) Used relations of CF. (3.1) Use some formal relations of CF.

(4) Did not use relations appropriated of CF o use informal relations.

(5) Use representations non-appropriated

(6) Appropriated calculations

(NA) No answer

From the perspective of the teacher-researcher, students gained a more formal theoretical knowledge that they possessed at the beginning. This learning was evident because the students could act at new situations and to account for the use of their rebuilt mental schemes, which we infer from their external representations. Although we note that some students failed to fully incorporate all the elements of some concepts into their schemes; we think that it is probably they need to solve more problems.

The opinion of students about the resources used in classroom and didactic experiences were:

- Demonstration: Allowed to display positions of bodies from different reference frames and observed the trajectories.
- Simulations: Allows distinguishing between the concepts, and applying them appropriately.
- Experimental data: The used technology allowed to quickly obtain the data for its study and compare with of the theory model.
- These resources maintain a motivation and focusing during the lesson.
- The reflection on the didactic strategy allowed us to assess it as a positive activity for our work of science teachers.

4. Conclusions

Structuring the learning content through of the field conceptual expressed in terms of situations, concepts and representations (Vergnaud, 2007), resulted suitable for promoting the progressivity of meaningful learning of concepts in science.

The comparison between the solutions to the problems on the test, before and after teaching, showed that students activated more elements of the physics concepts and more relations conceptual at the end; we consider these results how evidence of the conceptual learning.

The use of the demonstrations, virtual simulations and experimental data with *specific didactic intentions in a complementary manner* (Table 2) and integrated to the speech of the teacher and problem solving of paper and pencil during lessons, contributed favourably to mediate the conceptual learning in students. This didactic sequence is one way to make students understand the integration of models and theories with the phenomena and experimental activity.

This work is a contribution to science didactics; in reviewing previous studies we only find researches separately evaluating the effectiveness of experimental resources described (Beichner, 1990; Barberá & Valdes, 1996; Veit & Solano 2004, Golombek, 2008).

Given the importance of the conceptual structure to perceive, know and talk about the nature, the conceptual development is a priority in science education (in this case in physics). It is then important that teaching strategies should be generated with a significant rationale, to acquire a vision of the nature more accurately than our senses would allow produce. Therefore, we need to mediate the development of the mental and logical processes so that the foundations of the scientific thought may be constructed.

References

- Andrés, M. M, Pesa, M. & Meneses, J. V. (2007). A Learning Model (MATLaF) for Conceptual Development in Laboratory: Mechanical Waves Group. In Onne Slooten, O., Van Den Berg, E. and Ellermeijer, T. (Ed.) *GIREP Conference 2006, Modeling in Physics and Physics Education*. Netherlands: Amsterdam
- Barbera, O. & Valdés, P. (1996) El trabajo práctico en la enseñanza de las ciencias: una revisión. *Enseñanza de las Ciencias*, 14(3). Spain. 365-379.
- Beichner, R. (1990) The effect of simultaneous motion presentation and graph generation in a kinematics lab. *Journal of Research in Science Teaching*. New York, 27(8), 803-815.
- Buitrago, C. (2012). *Complementariedad de los medios didácticos para el aprendizaje del dominio teórico de la física*. Tesis of Magister in Physics Education. UPEL-IPC. Venezuela
- Golombek, D. (2008) *Aprender y enseñar ciencias: del laboratorio al aula y viceversa*. IV Foro Latinoamericano de Educación – Aprender y enseñar ciencias. Desafíos, estrategias, y oportunidades. Argentina: F. Santillana. <http://www.oei.es/noticias/spip.php?article2669>
- Moreira, M. A. (2006) Aprendizaje significativo: de la visión clásica a la visión crítica. In, *V Encuentro Internacional sobre Aprendizaje Significativo*, Madrid, Spain, September 2006.
- Veit, E. & Solano, A. (2004) *Tecnologias computacionais no ensino de ciencias*. Programa Internacional de Doutorado em Ensino de Ciências. Universidad de Burgos, Spain, Universidade Federal de Rio Grande do Sul, Brasil. (24).
- Vergnaud, G. (2007). In what sense the conceptual fields theory might help us to facilitate meaningful learning?. *Investigações em Ensino de Ciências*. 12(2). 285-302.

Appendix

Two items (1 and 11) of initial test and final test.

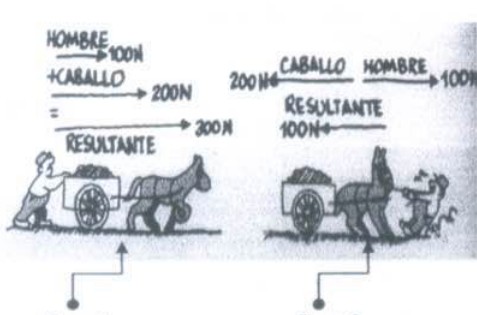
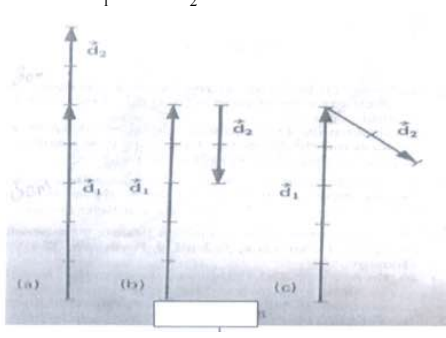
Item 1	
<p>(Initial test)</p> <p>In figure represent two cases:</p> <p><i>Case 1</i>, a man pushing the cart with a force of 100 newtons and a horse with a force of 200 Newtons in the same direction but opposite. We represent the resultant force.</p> <p><i>Case 2</i>, the horse resists with a force of 200 newtons force of 100 newtons applied by the man in the same direction but opposite. We represent resultant force.</p> <p>Imagine that a young and pushes the wagon in the same direction as the man with a force of 5 Newtons. Draw the resultant force in each case.</p>  <p style="text-align: center;">Caso 1 Caso 2</p>	<p>(Final test)</p> <p>Vectors \vec{d}_1 and \vec{d}_2 that shown in the figure represent displacements whose magnitudes are 5 cm and 2 cm respectively.</p> <p>a. Graphically represents the resulting vector in each case.</p> <p>b. Is appropriate to say that in all cases the resulting vector is the sum of the vectors \vec{d}_1 and \vec{d}_2?</p> 

Item 11	
<p>(Initial test)</p> <p>1. The following graph represents very roughly: position vectors A and B, the displacement vector from A to B, the vector average speed and instantaneous velocity vector for A.</p>	
<p>(Final test)</p> <p>2. An object initially located at $x = 100$ m at $t = 0$ s. It moves in direction x, 250 m each 10 s. Represents motion in a position-time graph. Describe a velocity-time graph movement.</p>	<p>2.1. An object initially located at $x = 50$ m at $t = 0$ s. It moves in direction $-x$, 250 m each 5 s. Represents motion in a position-time graph.</p> <p>2.2. For this object, determines the average speed and instantaneous speed for first 25 s and build velocity-time graph.</p>

Item 2 dealt with the same concepts and relationships of item 1.

Affiliation and address information

Carlos S. Buitrago

Universidad Pedagógica Experimental Libertador - Instituto Pedagógico de Caracas

Experimental Physics Teaching and Learning Research Group

Department of Mathematic and Physics. Torre Docente, piso 4.

Av. Páez, El Paraíso, Caracas 1020, Venezuela

e-mail: buitragoc36@gmail.com

Ma. Maite Andrés Z.

Universidad Pedagógica Experimental Libertador - Instituto Pedagógico de Caracas

Experimental Physics Teaching and Learning Research Group

Department of Mathematic and Physics. Torre Docente, piso 4.

Av. Páez, El Paraíso, Caracas 1020, Venezuela

e-mail: maitea2006@gmail.com

Inertial and Non-Inertial Frames: With Pieces of Paper and in an Active Way

Leoš Dvořák

*Department of Physics Education, Faculty of Mathematics and Physics,
Charles University in Prague, Czech Republic*

Abstract

A set of activities is described that can help the understanding of inertial and non-inertial reference frames. Using simple paper models, students can clarify and see on concrete examples how the same motion is described in different reference frames. Models enable the investigation of various types of reference frames: inertial, accelerated (moving in one direction) and rotated frames. Also, the motion of the object which is followed can be either uniform (with respect to inertial frames) or accelerated. This set of activities was piloted both in pre-service and in-service teacher training courses in Czech Republic.

Keywords

Classical mechanics, reference frames, simple models, active learning.

1. Introduction

Often, motion with respect to different reference frames is presented and described rather theoretically in textbooks and lectures for future physics teachers. Sometimes with nice drawings or photos, sometimes perhaps with some applets that can help understanding. In case of lectures, also experiments are of great help, of course. Nevertheless, often theoretical derivation is used as a simplest one.

To overcome this formal approach, a set of activities was developed that could enable teachers and students to perceive directly how transformations between different reference frames work. The activities use very simple paper models on which students “construct” various types of motion and their descriptions, with respect to different reference frames step by step. The purpose of these activities is to give students some concrete experience how motion is described in different frames, to provide tasks that can stimulate discussions and, in general, to help students to have a better understanding of this area.

To say this, we do not like to suggest that this approach should replace real experiments and video clips used in teaching this topic. Rather, it complements and supports them showing “how the theory works” or, to be specific, how transformations between different reference frames work.

Models enable the investigation of various types of motion and reference frames. In the workshop, we went through most of these possibilities, starting from simple uniform rectilinear motion (adding of velocities in one dimension) and ending at rotational frames (where Coriolis, centrifugal and Euler acceleration can be demonstrated and investigated). Surely, in real school teaching such concentration of activities would not be useful. Rather, different activities can be used when it is appropriate in short blocks. Also, these activities can be used at different levels: simple adding of velocities even at junior secondary level (pupils of age 12-15), activities including acceleration at senior secondary level (high school level) and activities concerning rotating reference frames at the end of high school level or at introductory university level. In fact, the basic idea of all these models is quite simple and teachers can easily modify the models and activities to suit the needs of their teaching.

This set of activities was piloted in both pre- and in-service teacher training courses. At the workshop in “Heureka Workshops 2013” conference in October 2013 in total more than fifty teachers participated at several runs of the workshop, with a positive feedback. Teachers appreciated that the models are very simple and low cost, can be easily modified and also that they can be used separately. Teachers reflecting on the workshop also stated that although the models and situations are basically simple, some parts of the activities were not so easy and really required them to think more deeply and to discuss some aspects of the tasks – which they, in fact, also appreciated. A similar rather positive feedback concerning flexibility, range of applications, simplicity and clarity of models was kindly expressed by participants of the workshop at GIREP-MPTL 2014 conference.

A detailed description of the models and their use was published in Czech in proceedings of Heureka Workshops 2013 conference (Dvořák 2013). Here, due to limited length of the paper, we describe the

principle of this approach and illustrate it by several examples. Worksheets of all twelve tasks done at the workshop at GIREP 2014 (in English) are available from the author upon request.

2. A common principle: simple paper models

All we need are just few pieces of paper and some paper rulers – such that are often available in some hobby markets. Alternatively, we can print the rulers at A4 sheets and cut them by scissors. Also, we need a sticky tape by which we will attach the rulers to a desk or to pieces of paper representing for example railway carriage. A paper tape which can be easily unstuck is ideal. All our models will have scale 1:100, i.e. each cm will represent one meter.

One reference frame (an inertial one) will be represented by a desk. A ruler parallel to the edge of the desk forms a coordinate system. We can say that, for example, the desk represents straight rails and a landscape around rails, the ruler measures the coordinate along the rails. A model of a railway carriage is just a piece of paper (we used one third of A4 sheet) folded so that it can slide along the edge of the table, see Figure 1.

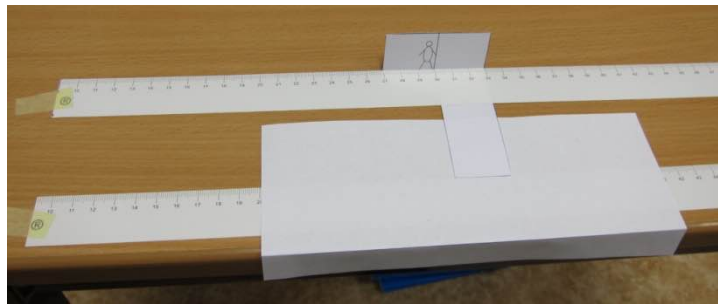

Figure 1. Basic components of paper modelling of reference frames.

As it can be seen in Figure 1, we can have also a very simple paper model of a man walking or running along the rails – second paper ruler attached to the desk enables to set position of the man. The prolonged part of the paper model of man enables to mark positions of the man with respect to the carriage, as Figure 2 shows.

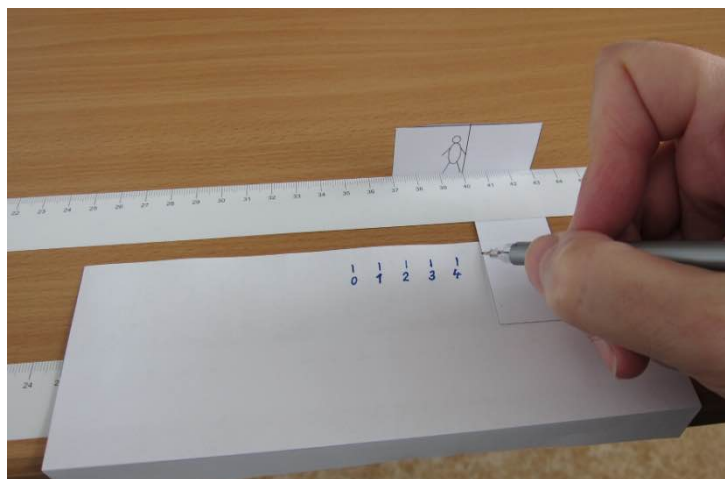

Figure 2. Position of the man in each second can be marked on the model of the railway carriage.

Students work in pairs. One student sets position of the carriage (the position of its left edge that can be easily read on the ruler), the other sets the position of the man. Either of them marks the positions at the carriage or at other reference frames. Motion – and our modelling – starts at $t = 0$ s. Then positions are set and marked at each second. It is useful to write the values of time next to the marks as it is shown in Figure 2. Then, motion of the object with respect to different reference frames can be analysed as we shall see in the examples below.

Basically, this is the principle of our modelling. It is very simple but it still requires students to realize which objects and reference frames move to which, on which rulers (i.e., in which coordinate systems) to read the values, to which piece of paper (i.e., to which reference frame) to draw the marks etc. And it visualizes the motion step by step, second by second. Also, it is not a passive visualisation done by some computer

software; students have to do everything by their own hands. Perhaps we can even say that they are, in a sense, part of the modelling. Or, to express it in a way of software modelling, they themselves are “the engine” that does the modelling.

Let us now look at several examples showing what situations can be modelled.

3. Inertial frames: motion in 1D

Perhaps the easiest possibility is shown in Figure 2. The railway carriage moves to the right with the speed 2 m/s, the man runs to the right with the speed 3 m/s (with respect to the rails). From the marks at the carriage one can clearly see (and measure) that the man moves with the speed 1 m/s with respect to the carriage. Various similar situations can be modelled, for example the case when the speed of the carriage is greater than the speed of the man. Also, either the man or the carriage or both can move to the left. (It is useful to use markers or pencils of different colours to draw marks for different velocities.) This activity can be used as a starting one, in which just the principle of our “paper modelling” is introduced and the known formula for adding (or, rather, subtracting) of velocities is confirmed – or students can discover the formula from the data they created.

We can also let the man move with respect to the carriage and mark its position to the landscape around rails. The motion of the man can be uniform but also accelerated, as Figure 3a shows. Now we have one ruler (one coordinate system) attached to the carriage, the positions of the man with respect to the carriage are set using this ruler. In the case shown in Figure 3a, the acceleration of the man with respect to the carriage is 1 m/s^2 . (It is convenient to have the table of distances from the starting position ready: 0, 0.5, 2, 4.5, 8, ...) Position in each second is marked both to the carriage and to the “landscape” (an A4 sheet of paper attached to the desk).

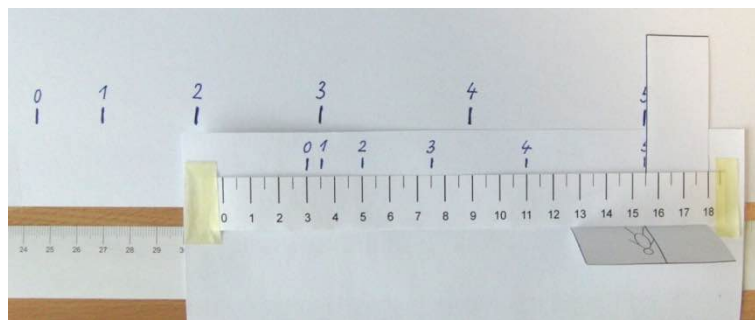

Figure 3a. Accelerated motion with respect to the railway carriage...

What can be derived from marks at the “landscape”? As can be seen in Figure 3b, it is clear that the motion with respect to the landscape is non-uniform. Also, distance of positions in consecutive seconds can be measured. Each of these distances was travelled in one second – therefore it represents an average velocity in the relevant second. For example, in case shown in Figure 3b, the average speeds are 2.5, 3.5, 4.5, 5.5, ... (all in m/s). So, the average speed is increased by 1 m/s in each second. From this students can directly infer that the acceleration with respect to the landscape is 1 m/s^2 , the same as the acceleration with respect to the carriage. (Of course, it must be so, both the landscape and the carriage are inertial frames, but here we see that the theoretical formula really works.)

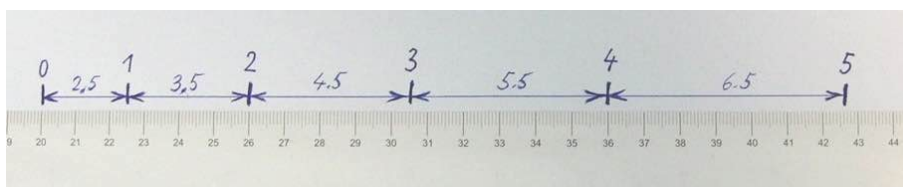

Figure 3b. ... is accelerated also with respect to the landscape; the acceleration can be found from distances of the marks.

4. Inertial frames: motion in 2D

Now, imagine that we look at the rails and the landscape from above. The railway carriage moves with constant speed (in the situation shown at Figure 4, it was 2 m/s). Somebody from the outside throws

something (for example a parcel) perpendicularly to the rails. What is the velocity of that object with respect to the carriage?

Figure 4 shows the motion of the object with respect to the carriage for two different speeds of the parcel (to the landscape, 1 m/s and 2 m/s in our case).



Figure 4. An object thrown from outside in the direction perpendicular to the rails.

Our model enables to see clearly that the direction of motion with respect to the carriage is not perpendicular to the rails; we can also directly measure the speed of the object with respect to the carriage.

Again, many different situations can be modelled – various combinations of speeds of the carriage and the object and directions of their velocities.

Let's add one general “technical note”: It is clear that the precision of setting positions of the carriage and the man and of drawing marks is not very high, errors of about 1 mm or even more can be expected as common. That's why the values of velocities in the worksheet to the tasks are such that distances of most marks are at least 1 or 2 centimetres. When compared to these distances, errors of 1 mm or so do not disturb us too much and we can persuade students that such errors can be ignored.

As an example of other situation in 2D, let us look at an accelerated motion of some object. Now we are looking at the carriage from side so in our model we will have two directions: direction of the rails and vertical direction. An object (a stone, a parcel or anything else) is dropped in a moving carriage. What is its motion with respect to the landscape?

Figure 5 shows both the model and the results for two different speeds of the carriage. Here, for the sake of clarity and simplicity, we take gravitational acceleration ten times smaller than the real acceleration on our Earth, i.e. 1 m/s^2 .

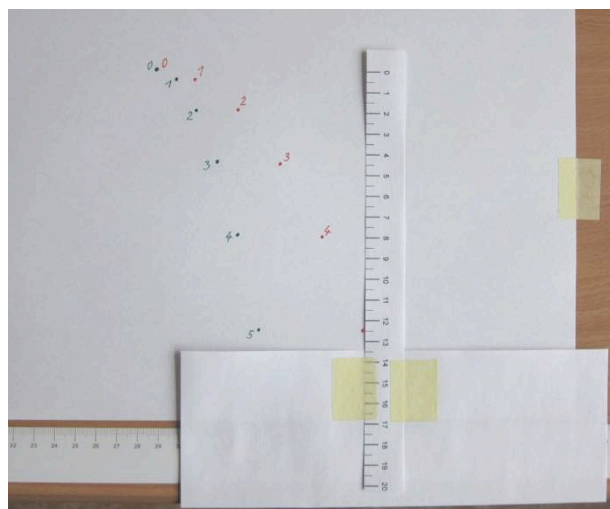

Figure 5. An object dropped in a moving carriage and its motion with respect to the landscape (side view).

5. Non-inertial frames: rectilinear motion

Paper models can be used also to model motion with respect to non-inertial frames. Now, the desk will represent inertial reference frame, our paper carriage an accelerated frame. Two simple tasks were part of the workshop: 1) accelerating carriage and the man standing still at the platform (which is at rest in inertial system) and 2) decelerating carriage and a man in it who is initially at rest with respect to the carriage and then continues to move with constant speed with respect to inertial reference frame (because no force acts to him, for example, he can stand on a skateboard). In both cases we see how the man moves with respect to the carriage, which can be a starting point of discussions on fictitious forces.

Even more interesting example is a falling elevator. Our model can illustrate why in such elevator we are in a state of weightlessness.

Our model is shown in Figure 6. At $t = 0$ the floor of the elevator is at height 20 m and its speed with respect to the Earth is zero – it just starts to fall. The man is standing in the elevator on its floor and jumps up with the speed 1 m/s. (We can discuss with students the fact that the speed is the same with respect to both the Earth and the elevator at $t = 0$.) Using simple high school formula $z = z_0 + v_0 \cdot t - g/2 \cdot t^2$ we can calculate the positions of both the man and the elevator in $t = 0, 1, 2, \dots, 6$ s. Again, for the sake of simplicity and clarity we take $g = 1 \text{ m/s}^2$. It is useful for students to write down the coordinates of both the man and the elevator in a table – setting of their positions is then easier.

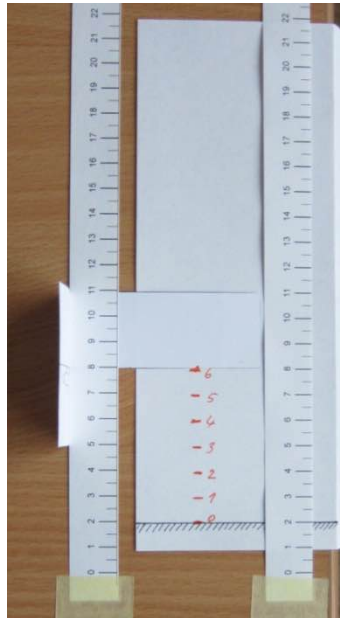

Figure 6. A man jumping in a falling elevator.

As can be clearly seen in Figure 6, the motion of the man with respect to the elevator is uniform (until the elevator hits the ground), as it is in absence of gravity.

6. Rotating frames

To model rotating frames, we need an axis around which a piece of paper – our model of a merry go-around – will rotate. Fortunately, there is no need to drill a hole into a desk to fix the axis. A drawing pin attached by a sticky tape to a desk will suit very well, see Figure 7.

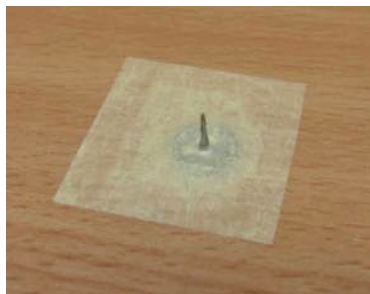

Figure 7. Drawing pin as an axis for our rotating frame (“merry-go-around”).

A sheet of paper attached to the desk will represent an inertial reference frame – we can say that it is an amusement park around our merry-go-around. It is useful to have a rose of directions on that sheet of paper – an angular scale, in our case the differences of marked directions are 10° and 5° , see Figure 8. A model of merry-go-around can be a paper circle or some symmetric shape. (We chose a hexagon because it is easier to cut it.)

It is easy to demonstrate and measure an effect of Coriolis force in our model, see Figure 8. An object, for example a ball, is thrown from the centre of rotating frame. Its motion is uniform and rectilinear with respect to the inertial reference frame. So, if we attach a ruler to the desk, our object moves (in our case to the right) along the ruler with constant speed (in our case 2 m/s, which means in our scale 2 cm for each step). Simultaneously, our merry-go-around rotates with constant angular speed $10^\circ/\text{s}$. (So, in each step we rotate it by 10° .) In each step we draw a mark at the rotating frame.

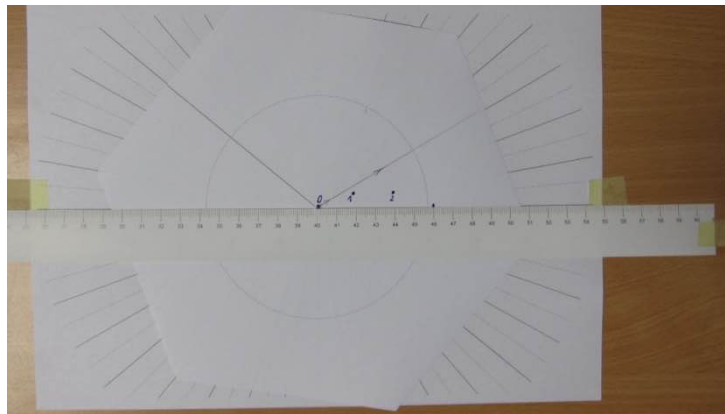

Figure 8. How to demonstrate an effect of Coriolis force on our paper model.

After removing the ruler we can see the trajectory of the ball with respect to the merry-go-around. In Figure 9, we rather roughly connected the marks to make the trajectory clearly visible. Students see that the trajectory is not rectilinear – it is as if something deflected it to the right from the direction of the velocity. This can be a starting point of discussion of Coriolis force. To show the variables on which Coriolis force depends we can change the angular velocity of rotation (also, to let the frame rotate in the opposite direction) and the speed of the ball. We can even measure the effect of Coriolis force quantitatively. However, it is necessary to have in mind that also centrifugal force influences the motion so satisfactory results concerning Coriolis force can be obtained only shortly after $t = 0$, when the distance from the axis is small and the ball moves more or less in radial direction.

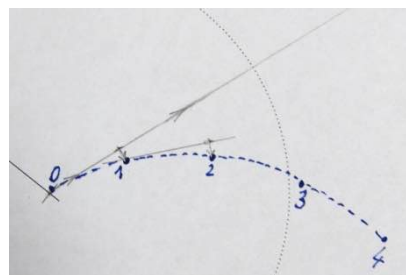

Figure 9. Result of modelling of the ball thrown radially from the axis: in rotating frame, the thrown object is deflected to the right.

Using similar modelling “experiments” we can demonstrate and measure also effects of centrifugal and Euler forces.

One advantage of these models lies in the fact that students clearly see that with respect to inertial reference frame the motion is rectilinear and uniform. (They construct this motion by their own hands!) This can be a good starting point for discussing whether e.g. Coriolis or centrifugal force can act in inertial reference frames and what the nature of these fictitious forces is.

7. Conclusions

All activities described above are in principle quite easy. However, students have to realize with respect to which reference frame they should measure which position – so, very concretely, which ruler to use to set some coordinate (of the man, of the carriage etc.). Also, when drawing marks showing positions in different times, they should realize to what frame to draw them. Even before starting to model any specific situation it is necessary to connect coordinate systems with relevant reference frames – i.e. to physically attach the rulers to objects representing reference frames (the desk, the paper model of a carriage etc.) It occurred that students (future teachers, in our case) really had to concentrate on the tasks. On the other hand, just this enables students to better grasp the transformation between reference frames. During these modelling activities, they really see and feel the transformation formulas “at work”.

As it was mentioned before, the models and activities can be adapted in various ways. They also enable students to express themselves even in some unexpected manners. For example, some teachers and future teachers drew some parts of landscape on a sheet of paper representing it – making it less abstract and more enjoyable. Therefore, we can expect that teachers will create different ways how to use these types of models to suit the needs of their teaching and their students.

In case you would like to try these activities, the author can provide upon request the English worksheets of all twelve tasks done at the workshop at GIREP 2014 (in pdf format) as well as simple templates of paper pieces of models described above (in cdr and pdf).

References

Dvořák, L. (2013). Inerciální a neinerciální systémy názorně. *Dilny Heuréky 2013/Heureka Workshops 2013. Proceedings of the conference of the Heureka project*, P3K, Prague, 14-34. (In Czech)

Affiliation and address information

Leoš Dvořák
Department of Physics Education
Faculty of Mathematics and Physics
Charles University in Prague
V Holešovičkách 2
180 00 Praha 8, Czech Republic
e-mail: leos.dvorak@mff.cuni.cz

“Elixir for Schools” – a New Initiative Supporting Czech Physics Teachers

Irena Dvorakova, Leos Dvorak

Faculty of Mathematics and Physics, Charles University in Prague

Abstract

This article describes a new initiative which aims at physics teaching and learning at lower secondary schools in the Czech Republic. The project is called “Elixir for Schools” and has two main parts – Regional Centres, and Tandems. We will discuss this project in detail with the aim to generalize our experience so that it can be useful for people from other countries who are engaged in physics education.

Keywords

Physics education, teacher training.

1. Introduction

Physics is not a favourite school subject in many countries. Pupils sometimes consider it boring, not interesting and not useful. The main goal of our project is to change this situation, to help pupils find the beauties of physics.

The Elixir for Schools project is an example of how a private company can support useful educational activities as part of its social responsibility. This project was prepared as the pilot project of The Depositum Bonum Foundation which was founded by the Czech bank Česká spořitelna. The first ideas of the project “Elixir for Schools” appeared in the autumn 2012. During the school year 2013/2014, which was the pilot year of the project, we gained positive feedback and many experiences which we plan to use in its further phases.

The project has two main parts: Regional centres and Tandems, see (Nadace Depositum Bonum, 2013). Moreover, the background ideas of the whole project are based on the “philosophy” of the long-term informal initiative Heureka; the project uses its experience and simultaneously supports its activities. Thanks to the project it was possible to create 18 regional centres where physics teachers can meet; during the school year, three more were opened. The other part of the project was teaching in tandems (physics teacher + master or PhD student) in eight schools.

2. Heureka

As mentioned before, the activities of the Elixir for Schools project are based on the experience of a long-term (more than twenty years) informal educational initiative, Heureka (already described at GIREP and some other conferences, see Dvořáková, 2014)). Elixir for Schools enabled us to scale up our previous work with teachers and to expand it to a higher level.

Heureka is based on the principle of active work in learning and teaching – both at school with students and in teacher training. Teachers in our seminars work the same way as students at schools – solving the same problems, doing the same experiments and sometimes even making the same mistakes. Our seminars provide long-term systematic training – the cycle of seminars for new participants takes ten weekends during the course of two years. That gives all participants the possibility and especially time to change their approach to teaching physics.

The character of our seminars is rather informal: the seminars are free of charge and teachers join Heureka on a voluntary basis, gaining no formal advantages or benefits at their schools. The seminars take place during weekends, with teachers staying (and sleeping) in classrooms. In the autumn of 2014, we will start already the 7th seminar cycle. Over the years, we have built a network of about 150 active teachers who have the possibility to meet at various advanced seminars and at the “Heureka Workshops” annual conference. The conference regularly attracts almost 120 participants and includes international guests.

3. Regional centres

During the preparatory phase of the “Elixir for Schools” project we discussed what were the main needs of teachers, what they are missing. We realized that teachers lack a community, and an opportunity to meet, to share experience and to discuss various problems.

We asked experienced primary and grammar school teachers from Heureka whether they would be willing to lead centres, which could support professional development of physics teachers in their regions. They agreed and in September 2013 the Depositum Bonum Foundation founded 18 Regional Centres for physics teachers all across the Czech Republic. The heads of the centres organize monthly meetings with other physics teachers who can share their experience there, discuss experiments and get new ideas for their teaching. They can also borrow some modern teaching aids from the Centre for their classes (e.g. a digital thermometer, digital microscope, model of steam engine, etc.) which individual schools either could not afford or have not bought yet. The value of teaching aids in each Centre is about 45 000 CZK (more than 1600 €). Excursions and lectures of invited guests could be other interesting parts of the program. The centre leaders can use some allocated money for paying the travel expenses for participants in excursions or for lecturers’ fees.

The meetings in the Centres are free and voluntary. The program is prepared by the leaders in accordance with the participants’ demands and needs. Approximately 200 people visit the Centres regularly and over 400 teachers have already attended the meetings. The feedback at the end of the school year proved that in many centres a community of teachers was already established, teachers appreciate the centres and actively participate in them.

To help participants to know more about the project “Elixir for Schools” we decided to organize the 1st conference for teachers from Regional Centres. It took place in May 2014. Some number that can characterize it: 174 participants, five plenary lectures, 31 workshops, 6 prominent guests in three days of conference program. What is more important is the fact that participants really appreciated the program and considered it very useful for their further work at schools.

It is our firm conviction that the idea of regional centres is transferable also to other subjects and we plan to find the ways how to support such new implementation.

4. Tandems

Within the TANDEM project’s activities, we have brought university students of some science and technology fields (e.g. students of Nanotechnology, Nuclear Physics, Astrophysics and Electro Engineering) into schools to work in tandem with teachers. The students usually did not have pedagogical education but they had at least some experience of working with children as leisure-time activity leaders.

Thanks to the unique opportunity to teach in a pair, teachers had more time for individual pupils and they could demonstrate more experiments in their classes. Also pupils appreciated the benefits of tandems very much. Detailed evaluation at the end of the school year revealed that after one year of tandem teaching, 77% of pupils described physics as interesting, which is 17% more than at the beginning of the project. 6% more pupils called themselves gifted or very gifted at physics and 5% more pupils now perceive physics as a popular or very popular subject. Another slightly unexpected benefit is the fact that children often saw for the first time how two adults collaborate and peacefully communicate during a class.

Our experience with these tandems was so good that we decided to offer tandem teaching as a form of ongoing teaching practice for future physics teachers at the Faculty of Mathematics and Physics, Charles University in Prague. This part of the project is now called Tandems 2.0. The old tandems (in some cases with new students because the old ones finished their studies) continue to work, now under the label Tandems 1.0.

5. How to generalize our experience

Can physics educators in other countries profit, at least partly, from our experience, or should they just state that we have been lucky to have a wealthy and enlightened sponsor? We think that some generalization is possible and our experience can perhaps be inspiring.

First, the sponsorship is not by any means extreme. In fact, it is orders of magnitude smaller than the scale of large national educational projects supported by, for example, the European social fund. Elixir for Schools rather tries to find and pilot new ways of support of teachers which, hopefully, can be financed by state or other subjects in the future. Also, the project is flexible and scalable. For example, Regional Centres could in principle run with rather small financial support. Money is a useful benefit, not the primary driving force. So, the first important ingredient of projects like this seems to be flexibility and scalability.

Second, the Depositum Bonum Foundation did not try to build the project top-down and from scratch. Instead, it looked for existing initiatives and informal projects that grew from below, through the activities of concrete teachers and groups of teachers. Thanks to that, Elixir to Schools could use the experience of a (moderately) large group of active and experienced teachers. So, the second lesson for similar projects could state: grow from below, use the potential, energy and experience of teachers.

Third, the Heureka initiative that was chosen as a starting point and background of Elixir to Schools was not some short lived or ad-hoc activity but rather a long-term informal project lasting for more than twenty years and still growing and evolving - a project, that can present respectable results. In the Heureka project we can find teachers whose experience and expertise was really proven by years – and this experience and expertise now plays a decisive role in the Elixir for Schools project. Our third lesson concerning educational activities and projects is therefore rather trivial but still worth to state explicitly: Long-time systematic work is not something obsolete, even in current fast changing world. Even in education, it can bear fruits. (Not to mention that it is satisfactory.)

The fourth aspect of our story is also not new: It pays off to connect people and encourage and support cooperation. Both Heureka and Elixir for Schools include physics teachers from all types of schools, from junior secondary, high schools up to universities. In Elixir, we cooperate with sociologists and experts on evaluation; our expert team includes teacher educators from eight universities in all parts of our country. We try to find other good, experienced and active teachers, other examples of good practice. In Heureka, we try to increase international contacts, to share ideas and experience and to gain further inspiration. It can be said that in both projects we try to give a very concrete content to today's fashionable word "networking".

The other ingredient which now proves to be important in Elixir for Schools is to offer a continuous support to people involved in the project. People should not be just "thrown in at the deep end" (neither in tandems nor in the role of leaders of regional centres). We will not specify here specific forms of such support, but one point should be stressed: it is necessary to find which support teachers really need, to ask them, to let them decide – and not just force upon them some "support" decided from above.

There might be some other aspects that can be discussed, but let us mention just one more. It is also a very natural piece of advice: Minimise bureaucracy, minimise administrative burden! Nowadays, various projects aimed at education offer good financial support and various advantages, but often at a price of enormous administrative burden (which, in addition, often seems more or less senseless). The management of Elixir for Schools really try to keep this burden at a minimal or at least very bearable level.

6. Conclusions

Detailed report on the first year of the project is available at web pages of the Depositum Bonum Foundation (2013), also in the English version. Anybody who is interested in our experience will be welcomed to come, see our activities and discuss any details. The project seems to have a perspective of at least several years (hopefully till 2020), so we plan its further evolution.

References

Dvořáková, I. (2014). Active learning in the Heureka Project. *Proceedings of the International Conference on Physics Education, ICPE-EPEC 2013*, Charles University in Prague, MATFYZPRESS publisher, 47-62.

Nadace Depositum Bonum (2013). Available online: <http://nadacedb.cz/en/elixir-for-schools/about-the-project>

Affiliation and address information

Irena Dvořáková
Department of Physics Education
Faculty of Mathematics and Physics, Charles University in Prague
V Holešovičkách 2, 180 00 Praha 8, Czech Republic
e-mail: irena.dvorakova@mff.cuni.cz

Effects of Gender and Teaching Practice in an Out-of-School Learning Lab on Academic Self-Concept of Pre-Service Physics Teachers

Markus Elsholz, Susan Fried, Thomas Trefzger

*Faculty of Physics and Astronomy, MIND-Centre for Science Teacher Education,
University of Wuerzburg, Germany*

Abstract

In this study the academic self-concept of pre-service physics teachers (N=63) has been assessed. The self-concept scale we used fits in the threefold structure of physics teacher education, which is physics, physics didactics and pedagogics. The three subscales thus can be linked to models of teachers' professional action competence, which include the three domains CK (content knowledge), PCK (pedagogical content knowledge) and PK (pedagogical knowledge). Effects of gender and teaching practice on the domain-specific self-concepts are investigated. We found significant interdependency-effects of gender and teaching practice on academic self-concept in the PK domain and main effects of gender in the PCK domain. At the second assessment point after a special course, which includes practical training in an out of school learning lab at university, almost none of these effects on academic self-concept can be stated anymore.

Keywords

Pre-service teachers, academic self-concept, professional action competence, science teacher education, out-of-school learning lab

1. Introduction

This study addresses the impact of teaching practice on the academic self-concept of pre-service physics teachers at the University of Wuerzburg (Germany). In particular it focuses on a special course at university, the 'teaching and learning lab' TLL. The course provides school-like interactions with school students at an out of school learning lab at university.

Interacting with students is a substantial part of teachers' profession. Pre-service in-class trainings therefore are very important experiences to prepare for the challenges of teachers' everyday life. During these trainings pre-service teachers get a realistic notion of their abilities and their potentials for development, especially in the PCK and PK domain. We therefore expect them to adjust their domain-specific academic self-concept.

2. Professional competence

According to Shulman (1986 & 1987) content knowledge (CK), pedagogical content knowledge (PCK), and pedagogical knowledge (PK) are basic elements of teachers' competence. But professional action competence as a tool to master job-related challenges includes much more facets than theoretical knowledge of content and strategies how to communicate it. Weinert (2001) outlines a definition of professional action competence: „The theoretical construct of action competence comprehensively combines those intellectual abilities, content-specific knowledge, cognitive skills, domain-specific strategies, routines and subroutines, motivational tendencies, volitional control systems, personal value orientations, and social behaviours into a complex system. Together, this system specifies the prerequisites required to fulfil the demands of a particular professional position.“

There has been much effort to build specific models that describe and operationalize this construct in relation to teachers' profession on international and national levels (e.g. TEDS-M: Döhrmann, 2014; COACTIV: Baumert, 2013a; MT21: Blömeke, 2008) . In Germany some groups currently work on models to fit for measuring teachers' competence in the fields of science and physics (Borowski, 2010, Riese, 2012; Gramzow, 2013). The model used in the COACTIV study (Baumert, 2013b) often provides a basis for that research. The model explicitly accounts for motivational aspects (Kunter, 2013), value orientations and beliefs about teachers and teaching as well as about learners and learning (Voss, 2013) to cover the notion of professional competence. However, most research focuses on the operationalization and the assessment of

CK, PCK and PK. Specific self-related constructs like teachers' academic self-concept are not systematically assessed.

3. Academic Self-Concept

The self-concept "refers to individuals' knowledge and perception about themselves in achievement situations" (Bong, 2003). It is a multifaceted, hierarchically ordered construct with the general self-concept on its top level and further academic as well as non-academic self-concepts (e.g. social self-concept) on subordinate levels (Shavelson, 1976; Marsh, 1985). At least two second-order academic factors - math and verbal academic self-concept - have to be assumed (Marsh, 1988) to sufficiently fit the data. The math/academic self-concept includes subjects like math, physical science, biology and economics, whereas the verbal/academic self-concept consists of self-ratings in the fields of geography, history and (foreign) languages. Marsh also published scales (self description questionnaire SDQI-III) to assess the different facets of self-concept for a broad age group (Marsh, 1984; Marsh, 1990). Its multifaceted structure also accounts for very weak gender effects in general self-concept due to counterbalancing sex-differences in the more specific self-concept facets on subordinate levels (Marsh, 1989). In their review Bong and Skaalvik (Bong, 2003) list certain key ascendancies of self-concept. Amongst others academic self-concept is affected by "reflected appraisals of significant others", "mastery experiences" and "frames of reference" against which to judge one's own accomplishments. Social comparison often is the most important source of information for self-concept. Marsh and colleagues (Guay, 2003; Marsh, 2005) showed that there is not an unique direction of causality in the coupling between self-concept and academic achievement in the sense that high self-concept increases academic achievement (self-enhancement model) or increased achievement causes higher self-concept (skill-development model). In fact academic self-concept and academic achievement are "reciprocally related and mutually reinforcing" (Marsh, 2005).

This short outline shows that academic self-concept is important for the discussion of professional competence not least because of its coupling to academic achievement. In the practical training course TLL described below, pre-service teachers (as in most other practical trainings) might undergo significant situations in contact with school students ('mastery experiences') and get feedback by experienced experts ('reflected appraisals of significant others') as well as by their fellow students ('social comparison'). We thus expect academic self-concept of pre-service teachers to be influenced by practical trainings.

4. Out of school teaching and learning lab

In 2009 a special course called 'teaching and learning lab' (TLL) has been implemented in physics teacher education at the Wuerzburg University. Its basic idea is that school students are taught in an out of school learning lab by physics pre-service teachers in order to enhance practical training in teacher education. TLL provides a school-like setting and the task for the pre-service teachers is to integrate and apply their content knowledge, pedagogical content knowledge and pedagogical knowledge. They work and teach in teams (social comparison) and receive feedback on their teaching from their team colleagues as well as from experienced experts (significant others). So the TLL-course takes up elements which are relevant for and should act on pre-service teachers' academic self-concept in particular in PK and PCK domain. The TLL-course spans 15 weeks of university training and is split into two larger periods.

4.1 Preparation Period

The preparation period covers the first 10-12 weeks of the TLL-course. During that period the pre-service teachers (about 25 per course) work together in small teams and design experiments and learning material for a certain physics unit (e.g. quantum physics, biophysics, optics) which focuses on inquiry based teaching. They have to recapitulate the underlying physics, choose content and experiments according to the school curriculum and agree to appropriate simplification and teaching strategies. The TLL lecturers thereby ensure the material to be appropriate in form and content. The preparation period ends in a session of role-play, in which half of the pre-service teachers enacting school students conduct the other team's experiments and provide feedback.

4.2 Practical Training

The remaining 3-5 weeks of the TLL-course are spent in practical training. A couple of school classes (about 6-8 classes) visit the lab on different dates for about 3-5 hours each. Pre-service teachers thereby supervise small group sessions with school students at the experiments they set up during the preparation period. After each session, pre-service teachers receive feedback from their fellow students (peer group) as well as from experienced experts and revise their units if necessary. Because pre-service teachers have dealt intensively

with the physics of their setup during the preparation period they can thoroughly focus on their teaching strategy and the school students' reactions to it during the practical training sessions. The practical training therefore offers a mock teaching situation to test different strategies teaching on a particular physics topic.

5. Research Interest

Amongst conventional in-class trainings the TLL-course is an essential training unit in physics teacher education at the University of Wuerzburg involving elements of team-teaching and feedback. An interview based pilot study (Trefzger, 2012) showed that after a TLL-course pre-service teachers report improvements in their preparation and instruction techniques. We assume the reflective practical training period of the TLL-course to support them in shaping appropriate teaching strategies and deriving professional acting routines.

Considering the mentioned ascendancies on academic self-concept (mastery experiences, reflected appraisals of significant others, social comparison) the research interest focuses on the impact of prior teaching practice and teaching practice during the TLL-course on the academic self-concept of pre-service teachers in physics teacher education.

6. Design and Methods

From April 2013 to July 2014 three TLL-courses took place. Data from overall $N = 63$ pre-service teachers (25 female, 38 male) has been assessed in a pre-post design during that period. Each pre-service teacher attended only one of the TLL-courses. Two-thirds attended the course in their 6th term at university, 15% attended already in lower terms (min term: 3rd), 13% attended in higher terms (max term: 10th), the remaining 5 % are missing values. The surveyed pre-service teachers had to answer a paper and pencil questionnaire at the beginning (T1) and the end (T2) of the TLL-course, respectively. At assessment points T1 (week 3 of TLL-course) and T2 (week 15 of TLL-course) academic self-concept has been assessed amongst some control variables like personal data (e.g. age, gender) and prior teaching practice (PTP).

Respecting the crucial role of frames of reference for the assessment of self-concept (Bong, 2003), we used self-concept scales, which consider four different reference norms (Dickhäuser, 2002). The pre-service teachers attending the study had to rate their individual skills in relation to the peer group (social reference frame, 's'), in view of individual achievements (individual reference frame, 'i'), regarding domain-specific requirements (criterion-oriented reference norms, 'c') and in terms of absolute statements (i.e. without any explicitly given reference norm, 'a'). Table 1 states some example items for the different reference norms in the self-concept scales: In the example, the 'challenge of learning new things' has to be rated four times considering four different frames of reference. Another argument in favour of the scales is that they had been constructed to assess the academic self-concept of university students.

Pre-service physics teachers are faced with a diversity of content and demands during their course of studies, which can roughly be structured into physics (CK), strategies for teaching physics (PCK) as well as psychological and pedagogical theories about teaching and learning (PK). As a global academic self-concept scale would not be sensitive to this diversity of demands, we slightly adapted the scales of Dickhäuser (2002) as follows: To cover the threefold structure in physics teacher education at university (CK, PCK and PK), we tripled the number of items in that each item of the original scale had been extended by three instructions of similar type, e.g. for the CK items: "Please rate this statement with respect to physics" (the term 'physics' being replaced by 'specific subjects of physics didactics' and 'general subjects of psychology and pedagogy' in the instructions for the PCK and PK items, respectively). Whenever domain specific self-concept values are reported in the following, they refer to this adaption of the instrument.

In addition, participants also had to rate their prior in-class teaching practice (PTP) by rating the item "How much in-class teaching practice have you been gathered up to now?" on a 4-point scale ("little", "rather little", "rather much", "much").

Table 1. Example items (translated by the authors) for the use of different reference norms in the construction of academic self-concept subscales (Dickhäuser, 2002).

reference norm	example items (7-point scale, semantic differentials)
Ref. (a): without explicitly stated norm (15 items in total – 5)	„Neues zu lernen im Studium fällt mir . . . schwer/ leicht.“ “In my course of study I learn new things ... with great

Ref (i): individual reference norm (18 items in total – 6 CK, 6 PCK, 6 PK)	„Wenn ich meine Entwicklung über die Zeit meines Studiums betrachte, dann fällt mir das Lernen von neuen Dingen heute . . . schwerer als früher/leichter als früher.“ “Considering my progress during the course of studies
Ref (c): criterion-oriented reference norm (15 items in total – 5 CK, 5 PCK, 5 PK)	„Gemessen an den Anforderungen des Studiums fällt mir das Lernen von neuen Dingen . . . schwer/leicht.“ “Considering the demands of my course of studies, it is ... hard/easy ... for me to learn new things.”
Ref (s): social reference norm (18 items in total – 6 CK, 6 PCK, 6 PK)	„Etwas Neues zu lernen fällt mir . . . schwerer als meinen Kommilitonen/leichter als meinen Kommilitonen.“ “Compared to my fellow students, it is ... harder/easier

7. Effects of gender and teaching practice on academic self-concept

In table 2 reliability coefficients, mean values and standard deviations of the domain specific academic self-concept ratings are reported for pre test data. We focus on PK and PCK domain because the TLL-seminar makes demands particularly on these domains but is expected to have only second order effects on self-concept in CK domain compared to physics lectures. Reliability coefficients are in good accordance with those reported in literature (Dickhäuser, 2002). In both PK and PCK domain the self-concept rating values in the individual reference norm (i) show the highest mean values whereas the mean values in the social reference norm (s) are significantly lower compared to the mean values of all the other reference norms. Figures 2 and 3 show the mean values of academic self-concept ratings for PK and PCK domain, respectively. The bars indicate the 95% confidence interval. Subplots are arranged in three rows and four columns. The plots in top row show the rating pre-values at the beginning of the TLL-course (‘Pre’). Self-concept gain during the course is plotted in the middle row (‘Delta’) and the bottom row finally shows post-values (‘Post’) at the end of the course about 15 weeks after the pre test. Pre and post values have been z-scaled (for mean values and standard deviations see table 2). Subplots in columns refer to one of the four different frames of reference used to construct the subscales of the instrument. In each plot rating values for male and female pre-service teachers are plotted against self-rated prior teaching practice (PTP). The PTP-ratings refer to the period before the beginning of the TLL-course, the PTP grouping thus being the same in pre and post data.

Table 2. Reliability coefficients (Cronbach's α), means (M) and standard deviations (SD) of the academic self-concept ratings in the PCK domain and PK domain. Letters (a), (c), (i), (s) indicate the subscales for different reference norms (see text for details). In each domain significant deviations in the distributions related to different reference norms are reported. Significance levels are indicated as follows: ‘.’ ($p < .1$), ‘*’ ($p < .05$), ‘**’ ($p < .01$), ‘***’ ($p < .001$)

PCK domain (rating range: 1 – 7)								PK domain (rating range: 1 – 7)							
	N	a	M	SD	(c)	(i)	(s)		N	a	M	SD	(c)	(i)	(s)
(a)	63	.90	4.84	0.84		.	***	(a)	63	.94	4.51	1.24			*
(c)	63	.88	4.85	0.89			***	(c)	63	.90	4.53	1.19			.
(i)	63	.87	5.10	0.92			***	(i)	63	.89	4.75	1.05			***
(s)	63	.89	4.31	0.74	***	***		(s)	63	.92	4.19	0.96	.	***	

Table 3. ANOVA results for the subplots of figure 2 and figure 3 (reported in case of $p < .1$).

	Ref	factor	p	η^2_{part}	p_s	$\eta^2_{s,part}$
PK domain						
Pre	(i)	SEX:PTP	.081	.060		
Pre	(s)	SEX:PTP	.050	.075	.080	.087
Delta	(a)	SEX:PTP	.025	.105	.006	.217
Delta	(s)	SEX:PTP	.008	.141	.024	.153
Post	(s)	PTP	.018	.110	.028	.138

<i>PCK domain</i>						
Pre	(a)	SEX	.022	.100	.006	.203
Pre	(i)	SEX	.040	.082	.094	.080
Pre	(s)	SEX	.049	.075		
Delta	(a)	SEX	.002	.192	.013	.184
Delta	(a)	PTP	.075	.067	.029	.145
Delta	(i)	PTP	.062	.074	.056	.113
Delta	(s)	SEX	.056	.077		

In Table 3 ANOVA results for the factors SEX and prior teaching practice PTP as well as their interdependency (SEX:PTP) are shown for the subplots of figure 2 and figure 3 (in case of $p < .1$). Results are reported for the complete group of surveyed pre-service teachers ($n=60$) as well as for the subgroup (index 's') of pre-service teachers who did not attend any further in-class training in addition to the TLL-course between pre and post test ($n=43$). Almost all significant effects of the factors SEX, PTP and SEX:PTP on the gain in academic self-concept ('Delta' data) remain significant in that subgroup with the effect sizes exceeding the effect sizes in the whole sample. So there is evidence that the reported effects can indeed ascribed to the TLL-course.

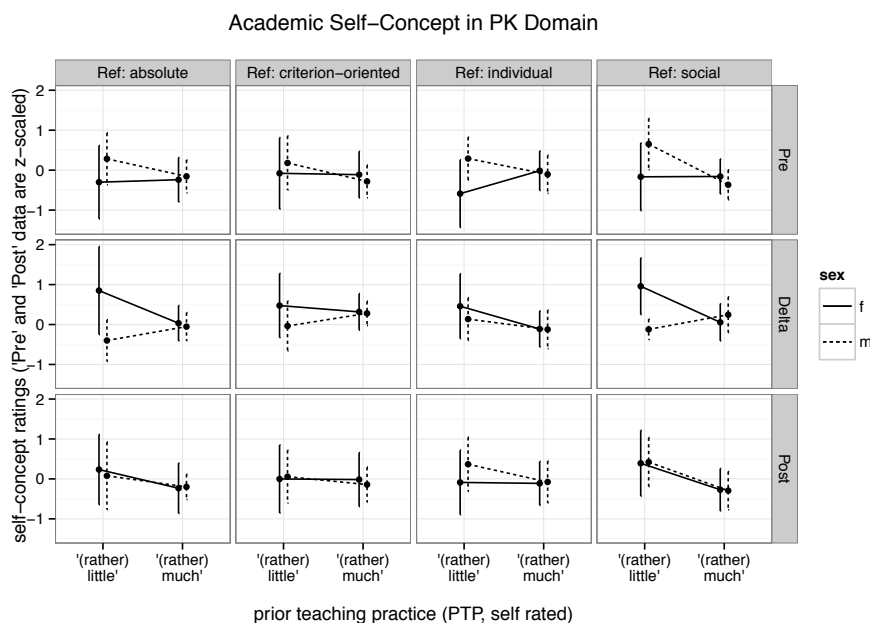

Figure 1. Means of self-concept ratings (PK domain). Bars indicate the 95% confidence interval for the mean. Plots in rows show rating values at the beginning of the course ('Pre', top), gain during the course ('Delta', middle) and the final values at the end of the course 15 weeks later ('Post', bottom). Columns represent the four different frames of references used to construct the subscale items (see text for details). Rating values are plotted against self-rated prior teaching practice (PTP) considering gender.

7.1 PK domain

In the PK domain ANOVA results show significant interdependencies of the factors SEX and self rated prior teaching practice PTP in both pre and delta data. Especially in the group of pre-service teachers who ascribe themselves '(rather) little' PTP, men tend to an above-average self-concept rating whereas women rate below average at the beginning of the TLL-course (see plots in top row of figure 2). Pre-service teachers (female and male) who declare to already have '(rather) much' PTP in contrast tend to an average rating value on the self-concept scale.

There seems to be a gender-specific re-evaluation of individual skills in the subgroup of pre-service teachers with low PTP. In particular we observe an obvious increase in women's academic self-concept during the TLL-course (see plots in middle row of figure 2, especially reference norms 'absolute' and 'social') whereas men's ratings almost remain stable. For the subgroup with no additional in-class training the interdependency

of SEX and PTP explains about 15% of variance in the ‘social’ reference norm and about 22% of variance in the reference-free subscale (see Table 3).

This re-evaluation of individual skills reduces the gender effect found in the pre data. After 15 weeks of TLL-course there is neither a significant effect of the factor SEX nor an effect of the interdependency of SEX and PTP on academic self-concept in the post data. Only in ‘social’ reference norm a main effect of PTP on academic self-concept can be observed in the post data.

7.2 PCK domain

While interdependency-effects play an important role in the PK domain, the PCK domain is dominated by the main effect of the factor SEX on pre and delta data. At the beginning of the TLL-course female pre-service teachers rate their PCK skills lower than their male fellow students with no effect of prior teaching practice (see plots in top row of figure 2). During the seminar women obviously adjust their self-rating (see plots in middle row of figure 3) with significant effects in the reference frames ‘absolute’ and ‘social’. Effects of PTP indicate that persons with low-rated PTP benefit slightly more than those with high-rated PTP. At the end of the TLL-course there are no significant differences in the self-concept ratings of males and females (see plots in bottom row of figure 2).

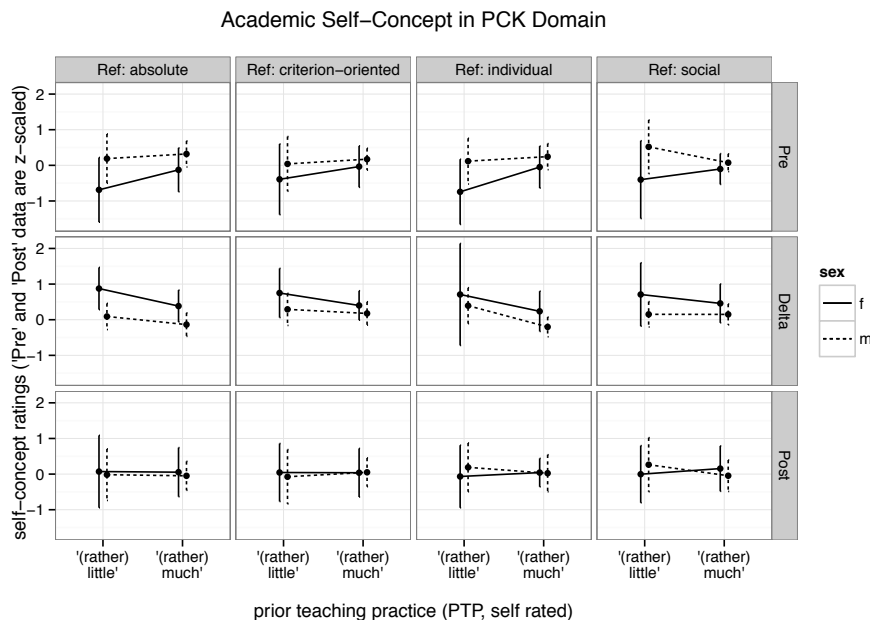

Figure 2. Means of self-concept ratings (PCK domain). Bars indicate the 95% confidence interval for the mean. Plots in rows show rating values at the beginning of the course (‘Pre’, top), gain during the course (‘Delta’, middle) and the final values at the end of the course 15 weeks later (‘Post’, bottom). Columns represent the four different frames of references used to construct the subscale items (see text for details). Rating values are plotted against self-rated prior teaching practice (PTP) considering gender.

8. Conclusion

Almost all of the pre-service teachers who attended this study gathered some prior teaching practice in several conventional in-class trainings before they attended the TLL-course. At the beginning of the TLL-course we find significant interdependency effects of the factors SEX and PTP on their academic self-concept in the PK domain (see plots in top row of figure 2). Gender differences are present in the subgroup of pre-service teachers who state to have ‘(rather) little’ PTP but vanish in the subgroup with ‘(rather) much’ PTP. We thus conclude that gender-effects on academic self-concept in the PK domain can be effectively reduced by gathering teaching practice during conventional in-class trainings. In addition, the TLL-course seems to be a chance particularly for female pre-service teachers with (in their own perception) little teaching practice. Their self-concept considerably increases, especially in the social reference norm (see plots in middle row of figure 2), which maybe ascribed to extended periods of team working and team teaching during the seminar enabling social comparison to the fellow students. After the TLL-course no gender effect on academic self-concept can be stated anymore, even in the subgroup of pre-service teachers who had ascribed themselves ‘(rather) little’ teaching practice at the beginning of the course.

In the PCK domain we don't find significant interdependency effects of SEX and PTP on the academic self-concept ratings in the pre data, i.e. more prior teaching practice PTP does not fully cancel gender-effects (see plots in top row of figure 3). But we find significant main effects of the factor SEX (see table 2). In almost all reference norms female pre-service teachers rate their domain specific skills significantly lower compared to their male fellows. Although women's self-concept slightly increases with PTP, as we don't see a decrease in self-concept for male pre-service teachers (with the exception of the social reference norm) the difference due to gender almost remains stable. During the preparation period of the TLL-course the participants have to deeply reflect on PCK-related issues of the learning material and the experimental setup they prepare for the school students (see also 4.1). Analysing the academic self-concept 'Delta' data (see plots in middle row in figure 3) it can be stated that female pre-service teacher benefit much more than male and those with low PTP ratings benefit slightly more than those with higher PTP ratings.

In both PK and PCK domain gender-effects and/or effects of interdependencies between gender and prior teaching practice on academic self-concept of pre-service physics teachers are present at the beginning of the TLL-course. We suppose teamwork during the preparation period of the course and team teaching during the practical training in combination with structured feedback to set up an appropriate frame, which causes pre-service teachers to re-evaluate and adjust the rating of their individual skills - in particular due to social comparison. After a 15 weeks period of TLL-course almost all of the differences in academic self-concept have been vanished, primarily due to obvious adjustments in academic self-concept of female pre-service teachers.

References

- Baumert, J., Kunter, M., Blum, W., Klusmann, U., Krauss, S., & Neubrand, M. (2013a). Professional Competence of Teachers, Cognitively Activating Instruction, and the Development of Students' Mathematical Literacy (COACTIV): A Research Program. In M. Kunter, J. Baumert, W. Blum, U. Klusmann, S. Krauss, & M. Neubrand (Ed.), *Cognitive Activation in the Mathematics Classroom and Professional Competence of Teachers* (pp. 1–21). Springer US.
- Baumert, J., & Kunter, M. (2013b). The COACTIV Model of Teachers' Professional Competence. In M. Kunter, J. Baumert, W. Blum, U. Klusmann, S. Krauss, & M. Neubrand (Ed.), *Cognitive Activation in the Mathematics Classroom and Professional Competence of Teachers* (pp. 25–48). Springer US.
- Blömeke, S., Lehmann, R., Schwarz, B., Kaiser, G., & Seeber, S. (2013). Untersuchungen zum mathematischen und mathematikdidaktischen Wissen angehender GHR- und Gymnasiallehrkräfte. *Journal für Mathematik-Didaktik*, **30(3-4)**, 232–255.
- Bong, M., Skaalvik, E. M. (2003). Academic Self-Concept and Self-Efficacy: How different are they really? *Educational Psychology Review*, **15(1)**, 1-40.
- Borowski, A., Neuhaus, B. J., Tepner, O., Wirth, J., Fischer, H. E., Leutner, D., ... Sumfleth, E. (2010). Professionswissen von Lehrkräften in den Naturwissenschaften (ProwiN)–Kurzdarstellung des BMBF-Projekts. *Zeitschrift für Didaktik der Naturwissenschaften*, **16**, 341–349.
- Dickhäuser, O., Schöne, C., Spinath, B. and Stiensmeier-Pelster, J. (2002). Die Skalen zum akademischen Selbstkonzept. *Zeitschrift für Differentielle und Diagnostische Psychologie*, **23(4)**, 393-405.
- Döhrmann, M., Kaiser, G., & Blömeke, S. (2014). The Conceptualisation of Mathematics Competencies in the International Teacher Education Study TEDS-M. In S. Blömeke, F.-J. Hsieh, G. Kaiser, & W. H. Schmidt (Ed.), *International Perspectives on Teacher Knowledge, Beliefs and Opportunities to Learn* (pp. 431–456). Springer Netherlands.
- Gramzow, Y., Riese, J., & Reinhold, P. (2013). Modellierung fachdidaktischen Wissens angehender Physiklehrkräfte. *ZfDN (Zeitschrift für Didaktik der Naturwissenschaften)*, **19**, 7-30.
- Guay, F., Marsh, H. W., & Boivin, M. (2003). Academic self-concept and academic achievement: Developmental perspectives on their causal ordering. *Journal of Educational Psychology*, **95(1)**, 124–136.
- Kunter, M. (2013). Motivation as an Aspect of Professional Competence: Research Findings on Teacher Enthusiasm. In M. Kunter, J. Baumert, W. Blum, U. Klusmann, S. Krauss, & M. Neubrand (Ed.), *Cognitive Activation in the Mathematics Classroom and Professional Competence of Teachers* (pp. 273–289). Springer US.

- Marsh, H. W., O'Neill, R. (1984). Self Description Questionnaire III: The Construct validity of Multidimensional Self-Concept Ratings by Late Adolescents. *Journal of Educational Measurement*, **21(2)**, 153-174.
- Marsh, H. W., & Shavelson, R. (1985). Self-concept: Its multifaceted, hierarchical structure. *Educational Psychologist*, **20(3)**, 107-123.
- Marsh, H. W., Byrne, B. M., & Shavelson, R. J. (1988). A multifaceted academic self-concept: Its hierarchical structure and its relation to academic achievement. *Journal of Educational Psychology*, **80(3)**, 366-380.
- Marsh, H. W. (1989). Age and sex effects in multiple dimensions of self-concept: Preadolescence to early adulthood. *Journal of Educational Psychology*, **81(3)**, 417-430.
- Marsh, H. W. (1990). A multidimensional, hierarchical model of self-concept: Theoretical and empirical justification. *Educational Psychology Review*, **2(2)**, 77-172.
- Marsh, H. W. (1990). Causal Ordering of Academic Self-Concept and Academic Achievement: A Multiwave, Longitudinal Panel Analysis. *Journal of Educational Psychology*, **82(4)**, 646-656.
- Marsh, H. W., Trautwein, U., Lüdtke, O., Köller, O., & Baumert, J. (2005). Academic Self-Concept, Interest, Grades, and Standardized Test Scores: Reciprocal Effects Models of Causal Ordering. *Child Development*, **76(2)**, 397-416.
- Riese, D. J., & Reinhold, P. D. P. (2012). Die professionelle Kompetenz angehender Physiklehrkräfte in verschiedenen Ausbildungsformen. *Zeitschrift für Erziehungswissenschaft*, **15(1)**, 111-143.
- Shavelson, R. J., Hubner, J. J. and Stanton, G. C. (1976). Self-concept: Validation of construct interpretations. *Review of Educational Research*, **46**, 407-441.
- Shulman, L. S. (1986). Those who understand: Knowledge growth in teaching. *Educational Researcher*, **15(2)**, 4-14.
- Shulman, L. S. (1987). Knowledge and teaching: Foundations of the new reform. *Harvard Educational Review*, **57(1)**, 1-22.
- Trefzger, T., Völker, M. (2012). Ergebnisse einer explorativen Untersuchung zum Lehr-Lern-Labor. In S. Bernholt (Ed.), *Konzepte fachdidaktischer Strukturierung für den Unterricht* (pp. 134-136). Münster: LIT-Verlag.
- Voss, T., Kleickmann, T., Kunter, M., & Hachfeld, A. (2013). Mathematics Teachers' Beliefs. In M. Kunter, J. Baumert, W. Blum, U. Klusmann, S. Krauss, & M. Neubrand (Ed.), *Cognitive Activation in the Mathematics Classroom and Professional Competence of Teachers* (pp. 249-271). Springer US.
- Weinert, F. E. (2001). Concept of competence: A conceptual clarification. In D. S. Rychen & L. H. Salganik (Ed.), *Defining and selecting key competencies* (pp. 45-65). Ashland, OH, US: Hogrefe & Huber Publishers.

Affiliation and address information

Markus Elsholz
M!ND-Centre for Science Teacher Education
University of Wuerzburg
Emil-Hilb-Weg 22
97074 Wuerzburg, Germany
e-mail: markus.elsholz@uni-wuerzburg.de

Revisiting Derivatives in Physics with Pre-Service Physics Teachers in K-12 Classes

Olga Gioka

Department of Secondary Science and Mathematics Education, Bogazici University, Istanbul, Turkey

Abstract

We report on our attempt to help pre-service physics teachers link concepts from different curriculum areas through the mathematical tool of derivatives and then, ask them to teach the particular content to K-12 students. The focus of the study was firstly, to document physics teachers' conceptions about derivatives and then, to develop a course for teacher education. In their 'teaching internship', pre-service teachers applied what they have learned in relation to derivatives and differentiation. The physics curriculum areas were those of kinematics, gravity, thermodynamics, R-L-C circuits and oscillations. We worked with thirty-two pre-service physics teachers during one academic year and developed instructional materials for K-12 classes. The study investigated how the designed tasks and our study groups supported physics understanding. We conducted interviews with students based on their marked coursework and audio-taped discussion between instructors and students. We also collected students' coursework and homework. Data analysis aimed at identifying their reasoning, difficulties and changes in performance on physics tasks. Although students improved their understanding of derivatives, some of the designed tasks were challenging even for the highest achieving of them. It is argued that students have difficulty in understanding fundamental concepts of physics as well as relating those concepts to the mathematics they have already learned in math courses. We conclude with some recommendations for pre-service physics teacher education and physics education research.

Keywords: Mathematics in physics, derivatives, pre-service teacher education.

1. Introduction

Mathematics is a critical part of physics learning. It is perceived as a language in physics. Mathematics, for many students, becomes a barrier to physics understanding and problem-solving. Students in calculus-based physics courses are often expected to have sufficient mathematical knowledge and skills to be applied to physics problems. Yet research on physics problem solving indicates that students' application of mathematics knowledge in physics problem solving does not happen as often, easily and fast as we expect. As Tuminaro and Redish (2004) argued, this is not because students do not have the necessary mathematical background but because they cannot appropriately activate those resources in a physical context.

Differentiation is a powerful mathematical tool widely used in many areas of physics. Understanding of differentiation and derivatives requires not only good mathematical knowledge but also a good understanding of the physical meanings of the variables and the quantity to be differentiated. In typical problems in calculus mathematics courses, students are given derivatives to compute. In contrast, problems in physics courses usually do not indicate that differentiation is needed to solve the problems. Students should recognize the need for differentiation, set up the expression for the derivative and compute it. More importantly, they should be able to explain its physical meaning: what differentiation and the derivative represent.

This research is part of a larger, ongoing project on how best to prepare pre-service physics teachers to teach in secondary schools (e.g., Gioka, 2012). The project is placed within the undergraduate program for physics students in our physics department. In the first three years of their undergraduate studies, our students take modules on mathematics, physics and participate in laboratory courses. In the fourth year, those who want to become teachers, participate in a program mainly oriented to physics teacher preparation and their certification as qualified teachers. The design of our pre-service teacher program is based on the argument made by McDermott (1990) about the need to design 'special' courses for prospective physics teachers.

In this paper, we report on our study aiming to support pre-service physics teachers to revisit physics problems of different domains through the mathematical tool of derivatives. We want to take a close look at student understanding and reasoning when applying the differentiation concept in physics problem solving. The following question guided the study: “*To what extent do students recognize and/or understand the relationship between the underlying mathematics of derivatives and the physics concepts involved?*”

A literature review is presented in the next section. In the following section we describe the context and research methodology of the study. The findings section follows with discussion and conclusions.

As part of the larger project, we have developed a series of instructional materials to address these problems with pre-service physics teachers. The content for both the research and curriculum development within this project is “Mathematics in Physics”. In particular, in this paper we will present the topic of “Differentiation and Derivatives”.

2. Literature Review

Research on students’ application of calculus in physics suggested that students may not conceptually understand mathematical processes although they can easily carry out the calculations (McDermott, 2001).

Thompson and his team (Thompson *et al.*, 2005) investigated teaching and learning in upper-level thermal physics courses. The particular topic was student understanding of partial derivatives in thermodynamics and Maxwell’s equations. Their results showed that students are often unable to apply the appropriate mathematical concepts and operations to the physical situations encountered in the related physics, although they had taken the prerequisite mathematics courses. In general, most students either explicitly mentioned or implied that other variables need to be held constant when dealing with partial derivatives, even if they did not constantly acknowledge this in their responses. Students also seemed to recognize that, given a partial derivative that contains well-understood physical variables (e.g., V, T, P), the mathematical expression represents “*the change in physical variable X as a result of a change in physical variable Y*”. Finally, most students extracted Maxwell’s equations from a given set of thermodynamic equations without much difficulty, but certainly after instruction.

Another study conducted by Christensen and Thompson (2012) looked at graphical representations of slope and derivative. By analyzing students’ use of mathematics in responses to conceptual physics questions, they found evidence that students often enter upper-level physics courses lacking the assumed prerequisite mathematics knowledge and the ability to apply it productively in a physics context. Among their findings are investigations on students’ understanding of kinematics, with particular attention to graphical representations of position-, velocity-, and acceleration-versus-time graphs. Underlying those physical quantities were relationships that depended on derivatives and slopes. Responses in question items related to the second derivative were not likely to be an issue of reading the slope of the curve.

In order to look at the same topic, Orton (1983) conducted clinical interviews with 110 students to investigate their understanding of derivatives. Overall, he found that the errors made by students were conceptual or fundamental and students found that the execution of the differentiation procedure was relatively easy. In an interview on the topic of rate of change and differentiation, various types of incorrect responses were apparent in students’ understanding of the notion dx . Orton pointed out that “*some students were introduced to differentiation as a rule to be applied without much attempt to reveal the reasons for and justifications of the procedure*”. In addition, the study conducted by Artigue and her team (1990) showed that students did not have a deep conceptual understanding of calculus concepts. That is, students learn the concepts as procedures and their understanding lacks of contextual meaning.

3. Research Methodology

3.1 The pre-service teacher education program and the participants

In our undergraduate curriculum, physics education modules are taught in classes of 100-120 students and they are mainly lecture-based. During the last years (2007 onwards) we have run a larger project designed to prepare prospective teachers for particular aspects of secondary physics teaching (e.g., Gioka, 2012). In order to be able to work with smaller numbers of students and implement particular strategies, we organized two seminars with thirty students in each one. We worked with these sixty students during the first semester and the same students from the same cohort in the second semester. The sixty students who participated were at the final year of their undergraduate studies and volunteers for the research study. During the seminars, they worked in smaller groups of three. The participants had successfully completed all the mathematics and calculus-based physics modules in the undergraduate curriculum.

In addition to helping students develop the in-depth content understanding that is imperative for success in the classroom, the courses encourage students to reflect on instructional strategies they experience (McDermott, 1990). During the course, the pre-service teachers begin the process of translating their own learning experiences into effective classroom practice. During their 'teaching internship' pre-service teachers implement their lessons which include differentiation and derivatives. The aims of the one-year seminars were to develop coherent conceptual understanding, promote problem-solving skills and draw students' attention to the physics '*behind*' mathematics. More specifically, the aim was to help them relate problems of different curriculum areas through the mathematical tool of integrals (Gioka, 2013) and derivatives. Our seminars started with a focus on helping students learn the meaning of the infinitesimal quantity (e.g., dx , dr , $dt...$) in the integral and the accumulation process underlying the integral. We developed a series of tutorials based on this research that focus on these difficulties related to differentiation and derivatives.

Over the five years, students were of similar attainment. However, in this paper we report on data from last year, since students' performance was the highest. We attribute students' best performance only to instructors' experience and support to pre-service teachers which has been improving with time.

In the seminars, teaching was explicit. We wanted to support them by employing 'scaffolding' and questioning strategies to advance their thinking.

Teachers collected coursework and homework problems and they gave back them to students with written feedback. In many cases we asked students to re-work on them by taking into account the provided written feedback. We wanted them to respond to provided feedback in order to improve their solution and understanding.

The problems we used were either taken from the standard physics textbooks or designed by us. All involved differentiation and calculation of derivatives (first- and second-class). They were problems on various topics and in various contexts of physics. We used the problems in the teaching and assessment process. The format of problems would vary during the period of one year. At the beginning of the academic year, we wanted to give more guidance on how to proceed (The details of the problem and its statement are provided in Figure 1). With time, we would give them freedom to choose the way they would work out the solution. Or, we would guide students through oral and written feedback to improve (Gioka, 2006). All problems were clearly asking students to make their reasoning explicit. This was proved to be a valuable source of their difficulties and likely improvement toward better understanding of derivatives and differentiation.

3.2 Research methods

In order to document students' understanding of differentiation in physics problems, we are primarily interested in looking closely at students' reasoning, which means to look at how they explain and justify what they are doing when they work out a problem. Therefore, students were asked to 'think aloud' while working on problems and in groups of three during the seminars. Seminars were observed by two researchers and discussions during seminars were videotaped. Careful observations of students during the seminars can provide important insights that can help us interpret student responses. All interviews were transcribed verbatim.

Also, semi-structured interviews were conducted with students on the basis of their marked coursework and the problems used in instruction. This is what we call 'problem-based' interviews. The purpose of the interviews was to explore their way of thinking and reasoning in more depth and detail. (Some interview questions are given in the Appendix). We developed interview protocols by taking into account research data from previous research studies in order to address related difficulties with concepts in the different curriculum areas (e.g., Beichner (1994) on kinematics, Formica et al (2010) on Newtonian dynamics, Kohlmyer et al (2009) on electromagnetism, Loverude, Kautz and Heron (2002) on the first law of thermodynamics, Cochran and Heron (2006) on the second law of thermodynamics). We also collected students' coursework and homework and looked through mistakes, difficulties and reasoning. Informal interviews provided additional information when required. This information together with the results obtained by the other methods of research can provide the kind of detailed knowledge necessary to answer our research questions.

3.3 Data analysis and limitations

In analyzing students' answers and reasoning (quantitatively and qualitatively), we attempted to trace changes and possible improvement in students' understanding of derivatives. We looked for the most common errors and difficulties and the emergent themes. One goal of the study was to document changes and improvement in their understanding of differentiation across the various curriculum areas of physics. There are obvious difficulties in monitoring the trajectories of students from initial performance on problem-

solving to expert and improved. Therefore, Gupta, Redish and Hammer (2007) argued that the alternative is to study a cross-section of the population at various stages of development. In our case, we decided to look at students' reasoning, difficulties and understandings during the one-year teacher education program. We want to make full use of the advantages of the selected research methods to get into the detail of student difficulties and progress. On the other hand, the context of only one physics department and the certain number of the participants limit the generalizability of results. Our findings cannot be generalized.

4. Results and Discussion

We found that there were a number of ideas related to differentiation and derivatives which although covered in math classes, many students were unable to apply in physics.

At the beginning, students could solve sets of practice problems as long as they knew which chapter the problems came from and so automatically used this information to decide which concepts and formulas were relevant.

S: *It will help me a lot if you tell me, in which chapter this problem is from. I then try to remember the appropriate equations ...*

I: *Is this what you really need?*

S: *Yes, because I am not sure if I should use equations for velocity and displacement.....*

I: *What about this graph? What does this graph tell you?*

They were able to perform the calculus necessary to solve a problem (although some calculus errors were occasionally observed). A small number of students did not recognize the physical meaning of the differentials treating them merely as algebraic equations. Although they possess the necessary mathematical skills, they failed to use or interpret them in the context of physics. "... *mathematics can be against my intuition...*"

In general, they were able to discuss the mathematical distinction between a partial and a total derivative. But they struggled with interpreting its physical meaning or applying it to unfamiliar contexts. A challenging problem was the RLC circuits and oscillations.

At the beginning, they tended to 'forget' mathematics (derivatives and so on), while they relied on equations and intuition because in secondary science teaching there are no derivatives and differentiation, hence, you do not need to know about them. "*I cannot think about difficult math in physics when I am a secondary school teacher*"

Some of the problems were challenging even for the most highly motivated and highest achieving students. Students were unable to apply the appropriate mathematical concepts and operations to the physical situations in difficult or unfamiliar curriculum areas (Maxwell's equations).

- *Now, mathematics makes more sense and makes teaching and learning of physics more meaningful* (their own expression) and,
- *'... that helps me a lot. I wish I had done it in my first year physics courses'*.
- *"We had not clearly understood all of this, even though we passed our exams"*

Many participants tended not to use calculus taught in mathematics courses (derivatives and so on), while they would rely on physics formulae, secondary school mathematics and intuition. Furthermore, when numerical values are not given in the problems, students are likely to rely on intuition. Students develop strategies for solving problems and pass physics without developing meaningful and deep understanding. According to their explanations, this is because in secondary physics teaching they are not supposed to be using differentiation. Or, they said that they expected that physics education modules not to include complex mathematics. This expectation is connected to the belief (also held by faculty members) that all physics and mathematics modules taught in the undergraduate program may be heavy, whilst physics education is much simpler and more straightforward. One can agree with Redish and colleagues that student expectations play a powerful role in how they think they are supposed to use mathematics in their physics classes (Redish *et al.*, 1998).

We identified several conceptual, mathematical and reasoning difficulties related to what it means to understand and perform differentiation in a physics context. First of all, we found that students had difficulties in distinguishing variables and constants within a derivative and the variable to differentiate.

Most of our students did not have difficulty recognizing the need for differentiation in solving the problems. Some of the problems were challenging even for the most highly motivated and highest achieving students.

Students were unable to apply the appropriate mathematical concepts and operations to the physical situations in difficult or unfamiliar curriculum areas (Maxwell's equations).

However, we found that students could set up an incorrect expression for the infinitesimal quantity. This would be in the case they could not interpret its physical meaning. For example, in the problem in which they were asked to find the maximum rate $(\frac{di}{dt})_{max}$ at which the current I changes in a L-C circuit, the key idea was that the equation of the current I is given by:

$$i = -\omega Q \sin \omega t$$

Then, by taking the derivative, one has:

$$\frac{di}{dt} = \frac{d}{dt}(-\omega Q \sin \omega t) = -\omega^2 Q \cos \omega t$$

We can simplify this equation by substituting CV_C for Q (because we know C and V_C but no Q) and $\frac{1}{\sqrt{LC}}$ for ω . We then, get:

$$\frac{di}{dt} = -\frac{1}{LC} CV_C \cos \omega t = -\frac{V_C}{L} \cos \omega t$$

This tells us about the current changes at a varying (sinusoidal) rate and we are able to calculate its maximum rate of change.

Most of our participants were not confident in describing and explaining its physical meaning.

Students significantly improved their understanding of derivatives and associated physics ideas with differentiation. Our participants' proficiency with derivatives was better and substantial in the later lessons around the end of the second semester. Better performance on derivatives means that the participants were more able to apply the already taught mathematical knowledge from calculus to the physics context. Also, students' improved attainment in the later lessons provided evidence of improved conceptual physics understanding. They could better solve physics problems using the concept of differentiation. As they noted in the seminars, instruction helped them better understand the mathematical processes and how mathematics expressions are related to the physics concepts. Also, the majority of them said that the seminars helped them to cross the gap between the mathematics, taught in a non-meaningful way, and physics which often learnt by heart. *'Now, mathematics makes more sense and makes teaching and learning of physics more meaningful'* (their own expression). Also, quite many of them said that they would wish that they had had such seminars in the first year of their studies and not in the final one because *'that helps me a lot. I wish I had done it in my first year physics courses'*.

5. Conclusion

Our findings align with and extend those from other research on students' understanding and difficulties with differentiation. We identified several conceptual, mathematical and reasoning difficulties. We found that the major difficulties students encountered when attempting to solve physics problems involving differentiation were due to:

- a) students' inability to understand the infinitesimal term and,
- b) failure to understand the physical meaning of derivatives.

Explicit teaching, instructors' support and feedback, as well making explicit their reasoning were important for students' improvement and better understanding.

We argue that good performance on differentiation requires mathematical skills but also a deeper understanding of the underlying physics. Many difficulties are interrelated and interdependent with conceptual difficulties in mathematics and therefore, must be treated together. However, the difficulties are primarily conceptual, rather than mathematical. Consequently, if as physics educators we want to improve understanding of derivatives, we should work on the particular aspects of teaching and learning.

This study is not an evaluation of our instructional approach and seminars. Nor we want to make recommendations for the teaching of mathematics and physics modules at the undergraduate level. Our intention is solely to look at prospective physics teachers' understanding of derivatives and help them improve through our pre-service teacher education program. Research should inform the development of programs for initial teacher education. Further research is necessary to look at the same issues but by involving in-service physics teachers. *'What do physics teachers think about mathematics and physics*

separation?' Also, we want to emphasize that physics staff should teach mathematics in their physics classes and not rely on students' mathematical understanding acquired from mathematics modules.

Findings from our study show that the particular problem requirements encouraged students to express their reasoning in their own words and hence, develop and improve deeper understanding. The participants significantly improved, deepened their understanding and could better solve problems by using the same mathematical tool of derivatives. Also, students reported that working on such format problems was a very meaningful process for them resulting to coherent understanding across various curriculum areas. They also appreciated the time and opportunities for more practice provided in seminars and much repeated practice. Development and expression of reasoning requires effort, practice and requires time.

In this paper, we have described how we investigate student difficulties with differentiation and derivatives and use the results of this research as a guide to curriculum development and preparation of pre-service physics teachers during their 'teaching internship' to K-12. We are currently using the curriculum developed at the University of Bogazici. In addition to carrying out preliminary study on the effectiveness of our materials, we are continuing to investigate the nature of student difficulties with differentiation and derivatives. The results of this ongoing research feed back into the curriculum development as part of an iterative process of research, curriculum development, and instruction.

References

- Artigue, M., Menigaux, J. and Viennot, L. (1990). Some aspects of students' conceptions and difficulties about differentials. *European Journal of Physics*, 11, 262-266.
- Beichner, R. J. (1994). Testing student interpretation of kinematics graphs. *American Journal of Physics*, 64(6), 714-719.
- Cochran, M. J. and Heron, P. R. L. (2006). Development and assessment of research-based tutorials on heat engines and the second law of thermodynamics. *American Journal of Physics*, 74(8), 734-740.
- Christensen, W. M. and Thompson, J. R. (2012). *Investigating graphical representations of slope and derivative without a physics context*. Physical Review Special Topics-Physics Education Research, 8, 023101.
- Formica, S. P., Easley, J. L. and Spraker, M. C. (2010). Transforming common-sense beliefs into Newtonian thinking through Just-In-Time Teaching. *Phys. Rev. ST Phys. Educ. Res.* 6, 210106.
- Gioka, O. (2006) Assessment for learning in physics investigations: Assessment criteria, questions and feedback in marking. *Physics Education*, 41(4), 341-346.
- Gioka, O. (2012). Preparing teachers to teach effectively in the school laboratory. In A. Lindell, A.-L. Kähkönen & J. Viiri (Eds.) *Physics Alive! Proceedings of the GIREP-EPEC 2011 Conference* (31-36). Jyväskylä: University of Jyväskylä. ISBN978-951-39-4801-6.
- Gioka, O. (2013) *Instructional Materials for K-12 physics classes*. Ioannina: Department of Physics, University of Ioannina (in Greek).
- Gioka, O. (2013). Linking different domains of physics through the mathematical tool of integrals. In the Proceedings of the First World Conference on Physics Education, "The role of context, culture and representation in physics teaching and learning". Bahcesehir University, Istanbul.
- Gupta, A., Redish, E. F. and Hammer, D. (2007). Coordination of Mathematics and Physical Resources by Physics Graduate Students. *Proceedings of the Physics Education Research Conference*, Greensboro, NC, *AIP Conf. Proc.* 951, 104-107.
- Kohlmyer, M. A., Cabellero, M. D., Catrambone, R., Chabay, R. W., Ding, L., Haugan, M. P., Marr, M. J., Sherwood, B. A. and Schatz, M. F. (2009). Tale of two curricula: The performance of 2000 students in introductory electromagnetism. *Phys. Rev. ST Phys. Educ. Res.* 5, 020105.
- Loverude, M. E., Kautz, C.H. and Heron, P. R. L. (2002). Student understanding of the first law of thermodynamics: Relating work to the adiabatic compression of an ideal gas. *American Journal of Physics*, 70(2), 137-148.
- McDermott, L. C. (1990). A perspective on teacher preparation in physics and other sciences: The need for special courses for teachers. *American Journal of Physics*, 58(8), 734-742.
- McDermott, L. C. (2001). Oersted Medal Lecture 2001: "Physics education research - The key to student learning". *American Journal of Physics*, 69, 1127-1137.

- Orton, A. (1983). Students' understanding of differentiation. *Educational Studies in Mathematics*, 14, 235.
- Pollock, E. B., Thompson, J. R. and Mountcastle, D. B. (2008). Student understanding of the physics and mathematics of process variables in P-V diagrams. *Proceedings of the Physics Education Research Conference, AIP Conf. Proc. 725*, 18-21.
- Redish, E.F, Saul, J. M. and Steinberg, R. N. (1998). Students' expectations in introductory physics. *American Journal of Physics*, 66, 212-224.
- Thompson, J. R., Bucy, B. R. and Mountcastle, D. B. (2006). Assessing student understanding of partial derivatives in Thermodynamics. In P. Heron, L. McCulloch and J. Marx (eds.) *Physics Education Research Conference* (pp. 77-80).
- Tuminaro, J. and Redish, E. F. (2004). Understanding students' performance on mathematical problem solving in physics. *Proceedings of the Physics Education Research Conference, Madison, WI, August 2003, AIP Conf. Proc. 720*, 11-14.

Table: Common difficulties and errors with differentiation and derivatives

Explain and make explicit their reasoning
Distinction between constants and variables
Make a distinction on which variable(s) to differentiate
Understand the formulae for differentiation
Practice with formulae for differentiation and derivatives
Understand the physical meaning of slope and continuity of derivation
Understand the concepts of slope and continuity of a line
Need to understand that continuity is a necessary condition for a derivative to be meaningful.
Understand the physical meaning of slope and continuity of a line.
Drawing the tangent line at a point of a curve and relate it to the limit.
Students need to calculate, if they exist, the maximum and minimum points of a function.
Understand that the second-class derivative of a function determines whether a critical point has extreme value or not.
Understand the critical points of a function by calculating out the first-class derivative in order to determine the maximum and minimum values of a function
Carrying out differentiation from $f(t)$, $f(x)$
Calculate the rate, average rate and instantaneous rate
Calculate the rate of change from a straight line graph
Calculate the average rate of change from a curve
Gradient of tangent to curve by differentiation
Understanding the physical meaning associated with differentiation

Appendix

Questions used in the interviews:

- What does [this] derivative mean?
- Why do you need to calculate the derivative?
- What is the physical quantity that dW represents?
- In your differentiation, what are the small pieces dx , $d\Phi$, dQ , dT that you add? Can you explain the physical meaning of these terms?
- Can you think of something you did earlier that might be relevant?
- Could you please explain to me how you worked this out?

Problem

A potential difference ΔV is connected across a device with resistance R , causing current i through the device. Rank the following variations according to the rate at which electrical energy is converted to thermal

energy due to the resistance, greatest change first: a) ΔV is doubled with R unchanged, b) i is doubled with R unchanged, c) R is doubled with ΔV unchanged and d) R is doubled with i unchanged. Explain your reasoning.

Affiliation and address information

Olga Gioka

University of Bogazici

Department of Secondary Science and Mathematics Education

North Campus, 34342 Bebek, Istanbul, Turkey

email: Olga.Gkioka@boun.edu.tr

In-service and Pre-Service Teacher Education in IBSE – the ESTABLISH Approach

Zuzana Ješková¹, Marián Kireš¹, Eilish McLoughlin², Odilla Finlayson²,
Christina Ottander³, Margareta Ekborg⁴

¹ Faculty of Science, Pavol Jozef Šafárik University in Košice, Slovakia,

² Dublin City University, Ireland,

³ Umea University

⁴ Malmo University, Sweden

Abstract

One of the main goals of the ESTABLISH 7fp project (<http://www.establish-fp7.eu/>) was the development and implementation of the professional development teacher education programmes (TEP) to support teachers in adopting inquiry-based strategies in their teaching. Within the project there was a model for in-service and pre-service teacher training in IBSE designed and implemented across 12 participating countries. The programme is based on 4 core elements and 4 additional elements that are built around the IBSE teaching units developed within the project. As accepted by ESTABLISH partners, all teacher training programmes includes the minimum of the four elements, i.e. introduction to IBSE, industrial content knowledge, teacher as implementer and teacher as developer of IBSE teaching materials. There are also four additional elements designed in detail, i.e. ICT for IBSE, argumentation in the classroom, research and design projects for students, assessment of IBSE. These can be added to the programme optionally with regard to the level of teachers' IBSE skills and current situation in education and teachers' professional development within the country.

This ESTABLISH model of TEP was followed in participating countries in order to change teachers' attitudes from traditional ways of teaching towards adopting inquiry strategies and their successful implementation in the classroom. Within the face-to-face workshops teachers experienced and developed their inquiry based teaching strategies using specifically developed materials. In addition, the e-platform has been developed to provide on-line support. This platform provides educators and teachers with all the necessary materials for the training and IBSE teaching units and other teaching materials for teachers' ongoing help.

The teacher training programme was successfully implemented in Slovakia. There were two runs of teacher training workshops on IBSE already carried out. Moreover, the additional element ICT in IBSE was developed more deeply designing a separate teacher training course for it. The contribution discusses in more details the success and problems of implementation in the context of Slovak educational environment.

Keywords

Teacher education programme, in-service teacher, inquiry, inquiry-based science education

1. Introduction

The main goal of ESTABLISH project has been the wide dissemination and use of inquiry-based education (IBSE) for second level students (aged 12-19) across Europe by bringing together, within a collaborative environment, the key stakeholders in science education. This goal has resulted in two main project outcomes: generating a suite of substantial teaching and learning materials (Units) and development of a series of educational supports for both in-service and pre-service teachers. The latter one involves development of Teacher Education Programmes (TEP) designed to promote the use of Inquiry-Based Science Education (IBSE) in classrooms across Europe. However, the challenge to develop and implement teacher education programmes in order to successfully implement IBSE in classrooms faces many obstacles. The background knowledge of inquiry varies greatly among teachers, as does the role of inquiry within the national curricula. Teachers as key elements of education are expected to change their methods of instruction towards more inquiry practices; however their strong beliefs and the way how they were educated can strongly influence their affection towards IBSE. Teachers' past education and the methods that they experienced during their own study can be strongly rooted in teachers' minds. Majority of teachers underwent traditional teaching based on transmission of knowledge rather than methods of instruction that are interactive and inquiry-based.

One of the main project challenges has been to try to change teachers' beliefs and teaching strategies. As a result there has been a model for in-service and pre-service teacher training in IBSE developed and implemented.

2. Teacher education programmes

The ESTABLISH consortium agreed to design a series of Teacher Education Programmes that have been developed around an agreed Framework for Teacher Education. The framework is based on four core elements as a minimum that all teacher programmes should include and four supporting elements that can be added to the programme optionally with regard to the level of teachers' IBSE skills and current situation in education and teachers' professional development within the country (fig.1, tab.1). The ESTABLISH framework calls for a programme of at least ten hours. However, overall duration may be dictated by the availability of participants and will also be decided influenced by the overall structure of the planned programme.

2.1 Introduction to IBSE

This short course presents a number of activities, scenarios and challenges to introduce IBSE. The main learning objectives of this part are to provide direct experience of inquiry, outline ESTABLISH view of inquiry and show benefits of learning by inquiry.

2.2 Industrial content knowledge (ICK)

This short course outlines a number of areas to show how the connection between science in the classroom and science in the real world can be strengthened, together with a number of activities to make science learning a more authentic and fruitful experience. The learning objectives are to encourage participants to be aware of the relevance and benefits of ICK in IBSE, appreciate the diversity and variation of ICK experiences and develop ICK for the inquiry lessons.

2.3 Science teacher as Implementer – Management

This short course should help to implement IBSE in the classroom using a number of activities and hints in order to:

- Reflect on practice of inquiry within the classroom
- Become effective in asking / owning ; managing / encouraging questions that can be investigated
- Design investigations that support analysing and interpreting data
- Find ways to help students to support their claims by generating / searching out evidence
- Manage and encourage communication within classroom
- Discuss different ways to perform an IBSE lesson
- Support the curiosity of students in the classroom

2.4 Science teacher as Developer – Feedback, Evaluation

This short course should help teachers in adapting or developing their own teaching materials once they reach the point of an advanced implementer of IBSE methods. In addition to the goals of the third element there are activities to:

- Outline criteria for inquiry levels, recognising the different levels of inquiry available (from guided to open)
- Design activities and develop lessons that are appropriate for the level of students' knowledge and curriculum content
- Demonstrate how to turn activities into inquiry
- Discuss which skills are needed for a teacher to scaffold inquiry
- Appreciate the variety of resources available online and in print media to source possible topics, scientific background etc.
- Appreciate the importance of giving time for reflection on self-developed inquiry lessons
- Outline and discuss classroom issues when teaching by inquiry
- Support colleagues to use IBSE in their own teaching and develop a community of practice to share experiences.

2.5 Information and Communication Technologies (ICT)

The aim of this element is to develop confidence and competence in the effective use of ICT in teaching and learning of science and in its appropriate use in inquiry-based teaching/learning.

2.6 Argumentation in the classroom

This element addresses skills to develop and manage effective argumentation in the classroom.

2.7 Research and design projects for students

This element is aimed at providing authentic experiences – address the development of these ideas, what aspects provide authenticity, student ownership and endorsement.

2.8 Assessment of IBSE

This element addresses assessment of many aspects of inquiry; how assessments can be changed to recognise the skills (cognitive, affective etc.) linked to IBSE.

It was envisaged that each country would implement elements I – IV in their in-service and pre-service science teacher education programmes but would incorporate elements V-VIII as required. The list of Support Elements is not exhaustive and may be added to, particularly for pre-service teachers, following experience of running these programmes. The elements of TEP are built around the units in physics, chemistry, biology and integrated science developed by ESTABLISH partners.

Table 1. Elements of Teacher education programme

	Core/supporting	Element
I	Core	ESTABLISH view of IBSE – intro to IBSE
II	Core	Industrial content knowledge ICK
III	Core	Science teacher as Implementer – Management
IV	Core	Science teacher as Developer – Feedback, Evaluation
V	Supporting	ICT
VI	Supporting	Argumentation in the classroom
VII	Supporting	Research and design projects for students – Evaluating evidence
VIII	Supporting	Assessment of IBSE

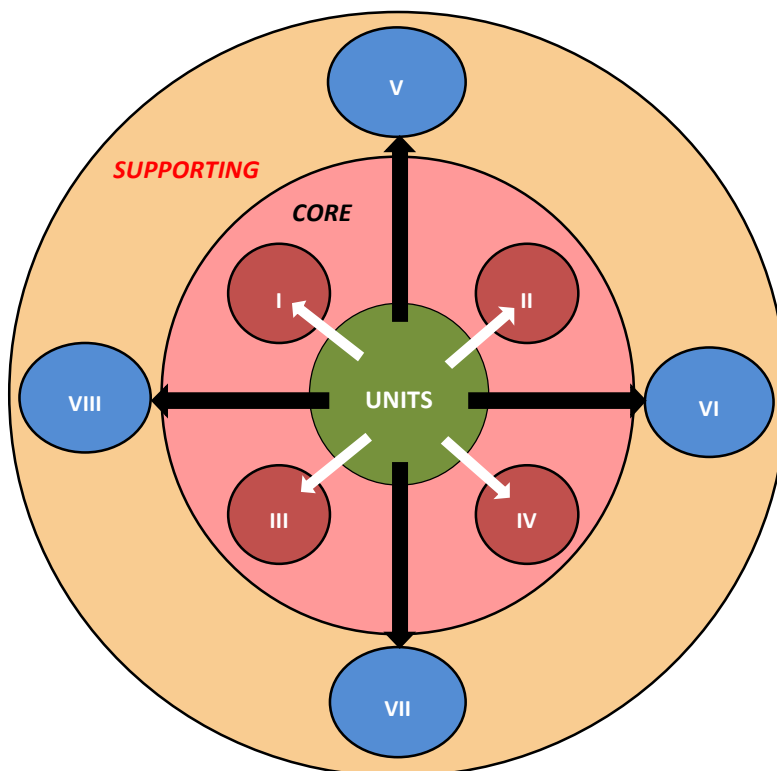

Fig.1 Framework for teacher education

3. Implementation of Teacher Education Programmes across partner countries

The ESTABLISH model of TEP was followed in participating countries in order to change teachers' attitudes from traditional ways of teaching towards adopting inquiry strategies and their successful implementation in the classroom. Within the face-to-face workshops teachers experienced and developed their inquiry based teaching strategies using specifically developed materials. In addition, the e-platform has been developed to provide on-line support. This platform provides educators and teachers with all the necessary materials for the training and IBSE teaching units and other teaching materials for teachers' ongoing help. In ESTABLISH partners have worked with teacher education in pre- and in-service programmes.

For TEP implementation there were common criteria agreed. Considering the extent of the education programme it was agreed that the minimum total time for in-service teacher training is 10 hours. It was strongly encouraged that the materials are trialled in real classroom. It was also recommended that training should be delivered over a minimum of three stages and minimum of two teachers per school should attend the workshops.

For pre-service teacher training the criteria were difficult to identify because of existing timetables for pre-service teachers. The workshops were recommended to integrate within the existing science education courses with particular module devoted to IBSE teaching. It was also encouraged implement IBSE in own teaching practice in the classrooms, or in microteaching sessions depending on the local conditions.

The number of teachers and students who have participated in programmes is shown in table 2.

Table 2. Number of in-service and pre-service teachers in teacher education programmes

Beneficiary	In-service teachers during 2011-13 Minimum criteria fulfilled	Additional in-service teachers during 2011-13 TEP shorter or lack of some Core Element	Pre-service teachers during 2011-13
Dublin City University	60	36	38+11+10
AG –Educational Services		17	0
University of Cyprus	67		33+29
University of Umea	25+6 teacher educators	117	10+34
Jagiellonian University	52	150 on lectures	64
Charles University, Prague	80		50
AcrossLimits Malta	23		5
P.J.Šafárik University Košice	50	40	17+8+5
University of Tartu	59	6	8+15+5
Palermo University	57	200	17+26
Malmö University	59	19	20
IPN Kiel	2+30	146	25+15
CMA Amsterdam	29		27
Martin Luther University Halle	24	65	200+6

4. Case study from Slovakia

Background of the TEP implementation

The teacher education programme was successfully implemented in Slovakia. The implementation has reflected the specificities of the educational system:

- The existing system of continuous education of in-service teachers ensures a systematic approach to teachers' professional development guaranteed by Ministry of Education. Within this system teachers are awarded credits for completion of accredited teacher training courses or for successful defence of the so-called 1st or 2nd attestation thesis. Formally, teachers are allowed to take 5 days off per school year in order to participate at teacher education programmes.
- There is a long-term tradition of teacher education programmes offered by universities (teacher training faculties) or educational institutions for teachers to enrol.
- There is an educational reform running from 2008 across all levels of primary and secondary education. The reform strongly emphasizes students' active learning with implementation of elements of IBSE that is explicitly included in science curriculum (tab.3).

Table 3. Elements of inquiry in science curriculum at upper secondary level, Slovakia in comparison with other countries (Cyprus, Czech Republic, Germany, Estonia, Ireland, Italy, Malta, Netherlands, Poland, Slovakia, Sweden). The elements are based on the definition of inquiry (Linn, Davis and Eylon, 2004)

Element of inquiry	CY	CZ	DE	EE	IE	IT	MT	NL	PL	SK	SE
Diagnose a problem		y	y	y		y	y	y	y	y	y
Critiquing experiment	y	y	y	y	y		y	y	y	y	y
Distinguishing alternatives		y	y	y		y		y	y	y	y
Planning investigations	y	y	y	y	y	y	y	y	y	y	y
Searching information	y	y	y	y	y	y		y	y	y	y
Constructing models		y	y	y		y		y			y
Debating with peers	y	y	y	y	y			y	y	y	y
Forming coherent arguments		y	y	y	y			y	y	y	y

The background positive side is that the system of TEP running in Slovakia enables teachers to participate at educational courses without significant obstacles. Also, as it can be seen from tab. 2, the current curriculum involves using IBSE teaching strategies. On the other hand, Slovak teachers are not educated in the field of IBSE and there are generally traditional methods based on transmission of knowledge used in teaching. There is also a lack teaching materials for teachers to use and there are mainly old textbooks based on traditional approaches available at schools. This way, teachers are in a conflict between the necessity of the implementation of inquiry activities and no experience and no materials available for it.

TEP implementation and its scenario in Slovak context

The model of TEP designed by ESTABLISH project partners was successfully implemented with in-service and pre-service teachers.

For in-service teachers the complete designed model was used with 12 hours of life sessions with 50 participants, i.e. physics (19), chemistry (13) and biology (18) teachers. The course scenario followed the model involving the TEP four core elements together with ICT element (tab.4). The elements were build around the existing teaching units developed within the ESTABLISH project that have been translated into Slovak and shared with teachers. Almost all of the participating teachers trialled selected activities in their own classroom. In addition, there was a single course on the role of ICT in IBSE developed in cooperation with CMA Amsterdam that has been successfully implemented with 39 participants (Ješková, et al., 2014).

Table 4. In-service teacher education programme in Slovakia

Session	Content
1st	Intro to IBSE, what is inquiry, hierarchy of inquiry activities, examples of good questions/ problems to answer, discussion on current situation concerning the use of IBSE in classroom
2nd	Group work on selected activities at different levels of inquiry, (mainly lower level), stress on interactivity and feedback Analysis of performed activities from the point of view of inquiry skills
3rd	Group work on inquiry activities enhanced by ICT, how to implement IBSE
4th	Inquiry activities with emphasize on industrial link How to turn activity into more IBSE activity, preparation for units piloting for volunteers

From the original number of 50 teachers, 25 (12 physics, 7 biology and 6 chemistry teachers) of them followed on with the accredited course in blended learning environment with 40 hours of life sessions and 25 hours of distant learning. The course was supported by the Moodle e-learning platform. Each of the participant was obliged to develop his own IBSE activity on the selected level of inquiry keeping the ESTABLISH units format (involving materials for teachers as well as for students – worksheets, files for computer, etc.). Teachers' projects were presented at the final defence (15 minutes presentation followed by discussion) in front of 3-members board.

Pre-service teachers of biology (17), chemistry (8) and physics (5) participated in IBSE module within the regular science education courses with different number of lessons (biology - 16 lessons, chemistry – 10 lessons, physics – 12 lessons).

Results

All the 50 teachers enrolled in the course completed the 12-hours programme. In addition, 25 teachers out of 50 continued and finished the course in the extended format within the accredited teacher training programme. In service teachers found inquiry teaching a rewarding experience. Based on their own experience with exemplary inquiry activities from the course teachers were highly motivated towards changes in teaching instruction. Majority of them implemented selected activities in their own classroom. For their final defence teachers were expected to develop their own inquiry activity that they did at good level with good understanding of what makes activity inquiry activity. However, based on observation of real lessons and videorecordings made during the lesson, it could be seen that teachers still lack the necessary skills for consistent application of IBSE methods in the classroom. Even after the training teachers tend to talk too much not letting students enough freedom and space to express their ideas and work on their own. The traditional methods are strongly rooted in teachers mind. The education programme motivated them towards wider use of IBSE methods; however they still need help in ongoing professional development to support the increased and correct use of IBSE in the classroom. The other important question is about the sustainability of their changing approach. Based on the interview and discussion with teachers it can be seen that teachers lack of support from the school management as well as from their colleagues. As a result, they usually remain alone in their efforts and this can lead to the loss of interest.

The course outcomes analysis resulted in general agreement on several steps that should be followed in order to provide teachers with ongoing help:

- Creating science teachers' teams with teachers educated in IBSE who can support each other within the school
- Support in designing projects at teachers own schools aimed at innovative methods and their implementation
- Influencing school management in order to make them supportive towards implementation of IBSE approach
- Designing national projects on inquiry-based science education involving schools with groups of teachers of different subjects that will be educated together and implement IBSE activities regularly and systematically across several subjects. This resulted already in a national project with 6 participating schools involving physics, mathematics and informatics teachers (national project VEMIV 2013-16).



Fig. 2 Implementation of inquiry activities on sound in the classroom

5. Conclusion

One of the main outcomes of the ESTABLISH project is the existing model of teacher professional development. This model has been successfully implemented in all project partners' countries. In Slovakia, there were specific conditions for its implementation regarding to the current situation in educational system. Nevertheless, the teacher education programme was successfully and effectively implemented and even developed into the existing accredited course. This course resulted in developing teachers' own IBSE activities with good understanding what IBSE means. On the other hand, there are still a lot of problems in appropriate implementation since the traditional approach methods are deeply rooted in teachers' attitudes towards students. However, the project ESTABLISH with its main outcomes (model of TEP, teaching and learning materials on IBSE) proved to be a very important milestone on the way towards changes in the Slovak classroom. Its' key ideas has become not only the motivation and starting point for IBSE but also the important basis for development of follow-up activities resulting in projects at national level that guarantee the continuation of the process towards successful implementation of IBSE approach in Slovakia.

Acknowledgement

Development and delivery of the course was carried out with the support of the ESTABLISH project (FP7/2007-2013 under grant agreement n° 244749).

References

- ESTABLISH project, available on <http://establish-fp7.eu/>
- Finlayson, O., McLoughlin, E., Brady, S. (2014). Evaluation of the impact of ESTABLISH IBSE Teacher education Programme on participating teachers, Proceedings of the SMEC conference: SAILS: Thinking Assessment in Science and Mathematics, 24-25 June 2014, Dublin City University, 7
- Ješková, Z., Tran, T., Kireš, M., Ellermeijer, T. (2014). Implementation of an in-service course on integration of ICT into Inquiry Based Science Education: A case study in Slovakia, Proceedings of GIREP conference in Palermo, 7-12 July, 2014, in press
- Linn, M.,C., Davis, E., A., Eylon, B.C. (2004). The scaffolded knowledge integratin framework for instruction, in Internet environments for science education, M.C. Linn, E.A. Davis and P.Bell, Editors. 2004, Lawrence Erlbaum Associates: Mahwah, NJ, 47-72
- McLoughlin, E., Finlayson, O., Brady, S. and Kireš, M. (2014). Establish – a model for widespread implementation of Inquiry Based Science Education, Book of abstracts of the SMEC conference: SAILS: Thinking Assessment in Science and Mathematics, 24-25 June 2014, Dublin City University, 6
- National project VEMIV, available on http://ufv.science.upjs.sk/_projekty/vemiv/
- Slovak national curriculum in physics for secondary schools, available on <www.statpedu.sk>
- Wenning, C., (2005). Levels of inquiry: Hierarchy of pedagogical practises and inquiry processes. Journal of Physics Teacher Education Online, 2 (3), 3-11

Affiliation and address information

Zuzana Ješková
Institute of Physics, Faculty of Science
Pavol Jozef Šafárik University in Košice, Slovakia
Šrobárova 2, 041 80 Košice, Slovak Republic
e-mail: zuzana.jeskova@upjs.sk

The Influence of Mathematical Representations on Students' Conceptualizations of the Electrostatic Field

Ricardo Karam¹, Terhi Mäntylä²

¹*Department of Science Education, University of Copenhagen, Denmark*

²*School of Education, University of Tampere, Finland*

Abstract

The electrostatic field can be conceptualized in different ways and in order to be able to connect them one must understand why vector and calculus formalisms are used to model electromagnetic phenomena. In this work, we categorize the mathematical representations used by physics teacher students to define central concepts of electrostatics and the physical justifications given by them for using certain mathematical formalisms. The results of our analysis show that many of the students were not able to make sense of essential mathematical tools for this theory (vectors and integrals), which prevents most of them from making meaningful connections between the different conceptualizations of the electrostatic field.

Keywords

Electrostatic field, Concept network, Physics teacher education, Mathematics in physics.

1. Introduction

The abstract character of the field concept poses a major challenge for physics education. In fact, a deep understanding of this theoretical construct seems to correlate with the ability to represent it in different ways (e.g. field lines, vectors, functions, differential operators, etc). Considering the electrostatic field, one student of an introductory course at university level will be introduced to (at least) three different ways to conceptualize it: SK1¹) *Coulomb* ($\vec{E} = \vec{F}/q$), where the field is defined in terms of the force acting on a test charge located in some point in space; SK2) *Potential* ($\vec{E} = -\text{grad}V$), which is derived from energy considerations and is enabled by the conservative character of the electrostatic field and SK3) *Gauss* ($\oint \vec{E} \cdot \hat{n} dS = Q/\epsilon_0$), where the notion of electric flux is central and symmetry arguments play an essential role.

In this sense, understanding the concept of electrostatic field is associated with the ability to recognize these different conceptualizations, to identify their applications as well as their limitations, and also to *connect* them through reasoning. Focusing on this latter aspect, we are mainly interested in the following question: What is the relation between a sound knowledge of mathematical representations and one's ability to connect different conceptualizations of the electrostatic field?

In this study, we analyze the influence of mathematical representations in the way physics teacher students structure their knowledge of electrostatics. Half-semester courses called "Concepts and Structures of Physics II" and "Concept Formation of Physics II" were given with the goal of deepening students' understanding of the electromagnetic theory and also to introduce them to a particular way of representing their knowledge with concept networks (similar to concept maps). A part of the course was dedicated to the teaching of central concepts, experiments and principles of electrostatics. One of the final products of the course was the students' creation of concept networks that express their knowledge of the electrostatic field and encompass the development of this concept. Together with the networks, the students wrote reports where they explained in detail the meaning of each node (concept, principle, experiment, model or law) and their connections. In this work, we correlate the mathematical representations used to define the core concepts of electric force, work, and flux with the connections they established between the three conceptualizations of the electrostatic field.

¹ SK is the abbreviation for Sähkökenttä, which means electric field in Finnish

2. Knowledge structure and concept networks

Physics teachers need an organized and coherent picture of physics and traditional lecture-based teaching seldom offers opportunities for physics teacher students to organize their knowledge in a coherent whole (Koponen, Mäntylä & Lavonen, 2004). For this reason, the technique of ordered concept networks, which emphasize the role of models and experiments in connecting physics concepts (such as quantities and laws), has been developed and evaluated for the purposes of physics teacher education (Mäntylä & Nousiainen, 2014). The concept networks have been applied in different topics, such as temperature (Mäntylä & Koponen, 2007) and electromagnetism (Nousiainen, 2013). The results show that the concept networks that students produce by themselves under the guidance of the instructor, help physics teacher students to organize, consolidate and reflect their knowledge of physics (Mäntylä & Nousiainen, 2014). Therefore, the concept networks are also applied in this study. They help students to visualize the structures of their knowledge and to concentrate on explaining the order and the connections of the concepts.

3. Expert knowledge: Feynman lectures on electrostatics

Even though concept networks are subjective representations of knowledge structures, the normative dimension plays an essential role in analyzing the quality of the networks, especially in such a hierarchically structured discipline like physics. In this work, we take Chapter 4 (Volume 2) of Feynman lectures (Feynman et al., 1964) as a reference for what expert knowledge in electrostatics looks like.

In the beginning of this chapter, Feynman states that Coulomb's law and the superposition principle is "all there is to electrostatics". Considering that the fundamental problem of electrostatics is to find the electric field when the charges' magnitudes, locations and distributions are given, in Section 4-2 Feynman derives a rather "frightening" expression for the x component of the electrostatic field:

$$E_x(x_1, y_1, z_1) = \int_{\text{all space}} \frac{(x_1 - x_2)\rho(x_2, y_2, z_2)dx_2dy_2dz_2}{4\pi\epsilon_0 \left[(x_1 - x_2)^2 + (y_1 - y_2)^2 + (z_1 - z_2)^2 \right]^{3/2}}$$

in which the field at a point (1) is determined by the charge distribution at an arbitrary point (2). Along his explanation, Feynman makes clear the necessity of using certain mathematical representations (vectors and integrals) in order to describe the physical situation fully. Even though he states that "there is nothing else to the subject besides this integral", Feynman stresses that the difficulty in calculating such complicated integrals over three dimensions motivated physicists to look for other ways to conceptualize the electrostatic field. This necessity leads to the concepts of electric potential (SK2) and electric flux (SK3).

In the following sections (4-3 and 4-4), Feynman calculates the work done against the electrostatic field to carry a unit charge from one place (a) to another (b). Due to the radial character of the electrostatic force, the calculation shows that the work is path independent, i.e., the electrostatic field is *conservative*. It is this conservative character of the electrostatic field that allows one to derive an expression relating the work done by the field (force per unit charge) with an expression that depends only on the initial and final positions of the charge:

$$W_{\text{unit}} = -\int_a^b \vec{E} \cdot d\vec{s} = -\frac{q}{4\pi\epsilon_0} \int_a^b \frac{dr}{r^2} = -\frac{q}{4\pi\epsilon_0} \left(\frac{1}{r_a} - \frac{1}{r_b} \right)$$

Then, the concept of electric potential is defined and its relation with the electric field ($\vec{E} = -\text{grad}V$) is derived.

It is important to note that the connection between SK1 (Coulomb's law) and SK2 (Electric potential) is only made possible if one represents the definition work of a force by an integral, since the electric force varies with the distance. Had work been defined by $\vec{F} \cdot \vec{d}$, it would have not been possible to connect Coulomb's law with the formulation of the electric field in terms of electric potential. This is one particular example where a mathematical representation (integral) affects the possibility of making meaningful connections between physical concepts.

In the next two sections (4-5 and 4-6) Feynman focuses on the notion of electric flux and emphasizes its modeling character by associating the field with the spreading of light or flying bullets. The core idea is to think that the inversed squared law is related with the natural way things spread out and that it might be a good strategy to use the same structure to think about the electric field. To avoid naïve literal interpretations, Feynman stresses that "there is no harm in thinking this way, so long as we do not say that the electric field is *made* out of bullets, but realize that we are using a model to help us find the right mathematics".

The concept of flux through an arbitrary closed surface is then defined by the integral $\oint \vec{E} \cdot \hat{n} dA$ and the need to consider only the normal component of the field is emphasized. Moreover, the fact that the shape of the closed surface does not influence the result of the integral is conceptually explained. The conclusion is that the integral of the scalar product between \vec{E} and the normal vector \hat{n} , taken over any closed surface A , is proportional to the net amount of charge inside it. This leads to the formulation of Gauss' law ($\oint \vec{E} \cdot \hat{n} dA = Q / \epsilon_0$) and enables the derivation of Coulomb's law from Gauss' in Section 4-7.

It is again worth mentioning that both the vector character of the field as well as the integral formulation are needed in order to make sense of this derivation. Thus, if one wishes to understand the deep connection between Coulomb's and Gauss' law, one must have a solid understanding of these mathematical representations. If the flux were defined as $\vec{E} \cdot \vec{A}$ or if the vector character of these entities had not been taken into account, it would have not been possible to establish such relation.

It is important to stress how certain mathematical structures (vectors and integrals) are needed in order to establish meaningful connections between Coulomb's law (SK1) and other ways of conceptualizing the electrostatic field (Electric potential - SK2 and Electric flux - SK3). The main focus of this study is to investigate the correlation between students' mathematical formulations of core concepts in electrostatics and the quality of the connections they make between these conceptualizations of the electrostatic field. In the next section we describe our research design and the categories of analysis.

4. Research context and design

The study was conducted in half-semester courses called "Concepts and Structures of Physics II" (5 ects) and "Concept Formation of Physics II" (5 ects). The participants of the former course had physics as their major subject and of the latter course as the minor subject. Both courses had the same curriculum and were aimed for physics teacher students with the focus on developing and consolidating students' knowledge of electromagnetism. The major students had studied physics at the university minimum 60 ECTS and the minor students minimum 25 ECTS before entering the courses. Therefore, although the curricula of the courses were the same, there were of course some differences in the depths of discussions during the courses due to the different backgrounds of the students.

The data was collected in two sets. The first set was collected in fall 2012 from the course "Concepts and Structures of Physics II" with five physics major students (3 females, 2 males) attending to it. Second set was collected in spring 2013 from the course "Concept Formation of Physics II" with twelve physics minor students (4 females, 8 males) attending it. The background knowledge concerning the students is presented in Table 1. The data consists of the students' final concept networks with the written explanations of the networks.

Table 1. Background knowledge about the participants and their scores of electrostatic questions (1-20) of CSEM² in the beginning and in the end of the courses. The grades in Finland go from 1 to 5.

Course	Student	Major subject	Starting year	Physics studies (ects)	Grade (average)	CSEM 1-20 pre	CSEM 1-20 post	CSEM Diff.
Concepts and Structures of Physics II	1	Physics	2009	67	3	14	17	3
	2	Physics	2006	183	5	17	18	1
	3	Physics	2008	60	3	13	16	3
	4	Physics	2009	62	4	18	19	1
	5	Physics	2007	90	2	20	18	-2
Concept Formation of Physics II	6	Mathematics	2010	25	4	15	17	2
	7	Mathematics	2008	60	4	17	18	1
	8	Chemistry	2004	25	4	14	15	1
	9	Mathematics	2008	29	2	14	15	1
	10	Mathematics	2010	42	2	10	15	5
	11	Mathematics	2012	38	3	19	20	1
	12	Biology			at least 25		19	19

² CSEM stands for Conceptual Survey on Electricity and Magnetism (see Maloney et al., 2001).

13	Mathematics	1999	32	4	18	19	1
14	Mathematics	2010	40	4	6	6	-
15	Geography	2010	52	4	15	18	3
16	Mathematics	2010	32	2	12	19	7
17	Mathematics	2011	30	4	17	18	1

The students were already familiar with the concept networks; they had done them in the previous course (the part I) in the area of mechanics. The concept network consists of nodes and links. The nodes are concepts such as quantities, laws and principles. They are also models and experiments, which justify the order and the connections in the networks. Links include short link words such as defines, analysis, analogy, is measured, is varied. The links and nodes are numbered, which shows the order of the network. In the written explanation, which follows the order of the network, the nodes are described and explained in detail.

The task given to the students was to produce a concept network with a written supplement, which represents their understanding of formation, development and generalization of the electric field concept. The task was organized around the three conceptualizations of the electrostatic field and the most central concepts (mainly quantities and laws) were given to the students. However, students had to design themselves how to connect the concepts to each other using mainly models or experiments. The mathematical representations were inherent part of the descriptions of the concepts, models and experiments.

The duration of the teaching sequence of the electrostatic field was about two weeks. First, students produced the initial versions of the concept networks. Then, in the lessons, the electrostatics was discussed in run-through-like at the introductory physics level. The students were paired and they gave feedback to each other on their initial networks. In addition, the instructors gave feedback to the students. Finally, students revised their initial versions based on the feedback and lessons and returned the final reports including the concept network and its written explanations concerning the electrostatic field. Altogether, the data consist of 17 final reports and in following, the analysis of the students' use of mathematical formalism in their reports is described.

5. Categories of analysis

Given the afore mentioned correlation between the kinds of mathematical structures and the possibility to make meaningful connections between different conceptualizations of the electrostatic field, our first categorization addresses the type of mathematical formalism used by the students to define central concepts of electrostatics in their reports. The concepts chosen were Force & Field (SK1), Work & Potential (SK2) and Flux (SK3). We categorized their representations according to the presence (or not) of calculus and vector notations. This categorization is summarized in Table 2.

Table 2. Categorization of the kind of mathematical representations used by the students to define central concepts in electrostatics. The first row distinguishes merely algebraic (ALG) representations from the ones utilizing calculus (CAL) notations such as differentials and integrals. The second row focuses on the difference between scalar (SCA) and vector (VEC) representations.

	Force & Field - SK1	Work & Potential - SK2	Flux - SK3
(ALG)	$F = \frac{1}{4\pi\epsilon_0} \frac{q_1q_2}{r^2}$ $Q = \rho V$	$W = Fs$ $V = U/q$	$\Phi = EA$
(CAL)	$Q = \iiint \rho dV$	$W = \int_{s_1}^{s_2} F \cdot ds$ $V(r) = -\int_{\infty}^r E \cdot ds$	$\Phi_E = \int E \cdot dA$
(SCA)	$F = \frac{1}{4\pi\epsilon_0} \frac{q_1q_2}{r^2}$ $F = Eq$	Fs $Fs \cos\theta$	EA $EA \cos\theta$
(VEC)	$\vec{F}_{12} = \frac{1}{4\pi\epsilon_0} \frac{q_1q_2}{r_{12}^2} \hat{r}_{12} = -\vec{F}_{21}$	$\vec{F} \cdot \vec{r}$	$\vec{E} \cdot \vec{A}$

The kind of mathematics used in these definitions is already a strong predictor of the students' capability to make meaningful connections between different domains (SK1 \rightarrow SK2 and SK1 \rightarrow SK3). As previously mentioned, solely algebraic representations will prevent students from deeply understanding situations where magnitudes are not constant (e.g. Coulomb's force dependence on the distance). The lack of vector formalism will be particularly problematic for understanding the projections (scalar product) involved in 3-dimensional situations.

Nevertheless, the kind of mathematical representation used in their reports is not sufficient for ensuring that deep connections will be established, since it is still necessary to investigate how the students make sense of these representations. Thus, another category to analyze the justifications/explanations given by them was created. This aspect was categorized into the following three hierarchical levels:

Level 1 - Authority

The concepts are simply presented without any kind of justification.

Example (S7): When the charge is moving in the electric field, the electric force makes work, which is given by the usual definition from mechanics: $W = Fs$

Level 2 - Procedural or inductive derivation

Mathematical derivations are presented in a procedural way; no or insufficient explanation/interpretation of the procedure is given.

$$\text{Example (S1): } \phi_E = \int_A \epsilon E \cdot dA = \int_A \epsilon \frac{1}{4\pi\epsilon} \cdot \frac{Q}{R^2} \cdot dA = \frac{1}{4\pi} \cdot \frac{Q}{R^2} \int_A dA = \frac{1}{4\pi} \cdot \frac{Q}{R^2} \cdot 4\pi R^2 = Q$$

Or the law or quantity is represented in mathematical form and justified as being derived from an experiment.

Level 3 - Sense making

Clear physical justifications for the use of particular mathematical representations are given. Calculation steps are explained along the derivations. Often analogical and/or visual reasoning is provided.

Example (S2): In a conservative field, when you move the charge from point A to point B, the work does not depend on the path. Furthermore, the total energy is conserved. Thus, it is possible to define a place-dependent potential energy. Consider a situation in which a particle charge Q is at rest and calculate the work to move a particle with a charge q , from a distance infinitely far away from the charge Q to a distance r from it.

$$W = \int_{\infty}^r F \cdot dr = \int_{\infty}^r -F_e \cdot dr = \int_r^{\infty} F_e \cdot dr = kQq \int_r^{\infty} \frac{1}{r^2} dr = k \frac{Qq}{r}$$

Assuming that the particles are at rest in the beginning and end, and the principle of conservation of energy, we can now define the electric potential energy as $E_p = k Qq/r$. The zero level is set at infinity.

6. Results

We analyzed how the students defined central concepts of electrostatics in their reports according to the categorization dimensions presented in the previous section. The results are synthesized in Table 3.

Table 3. Categorization of both the kind of mathematical representations (Algebraic or **Calculus**; Scalar or **Vector**) used by the students to define central concepts in electrostatics (Force & Field, Work & Potential and Flux) and the quality of explanations given in the reports (1, 2, 3).

St	F & E			W & V			Flux		
	Alg/Cal	Sca/Vec	Exp	Alg/Cal	Sca/Vec	Exp	Alg/Cal	Sca/Vec	Exp
1	Alg	Sca	2	Alg	Sca	2	Cal	Sca	2
2	Alg	Sca	3	Cal	Vec	3	Cal	Vec	3
3	Alg	Sca	1	Alg	Sca	3	Cal	Sca	2
4	Alg	Vec	3	Cal	Vec	3	Cal	Vec	2
5	Alg	Vec	3	Cal	Vec	3	Cal	Sca	2
6	Alg	Sca	2	Alg	Sca	2	Cal	Vec	2
7	Alg	Sca	1	Alg	Sca	1	Cal	Sca	1
8	Alg	Sca	1	Cal	Sca	1	Cal	Sca	1
9	Alg	Sca	1	Alg	Sca	1	Cal	Sca	1
10	Alg	Sca	1	Cal	Sca	1	Cal	Sca	1
11	Alg	Vec	2	Cal	Vec	2	Cal	Vec	2
12	Alg	Sca	1	Cal	Sca	2	Cal	Sca	1
13	Alg	Sca	3	Cal	Vec	3	Cal	Vec	1

14	Alg	Vec	3	Alg	Sca	1	Cal	Sca	1
15	Alg	Vec	1	Alg	Sca	1	Cal	Sca	1
16	Alg	Sca	1	Alg	Sca	1	Alg	Sca	1
17	Alg	Vec	2	Alg	Sca	2	Cal	Vec	2

Concentrating the analysis on the three electrostatics concepts (columns), the main findings are:

F & E: All the students represented Coulomb's law algebraically. This implies that they disregarded situations where charge density came into play, i.e. they treated interactions mainly between point charges, but did not mention situations involving charge distributions. 6 students used the vector notation and they were usually better at explaining the mathematics. Most students presented Coulomb's law without any justification and many stated it as the mathematical representation of an experiment (Pure induction - Level 2), focusing only on the inverse squared dependence disregarding the vector character.

W & V: The calculus representation is essential for connecting Coulomb's law with the electric potential and only half of the students used it in their reports. The others defined work algebraically ($W = Fd$) and were able to talk about electric potential only for situations in which the field was constant. Regarding the explanations related to the mathematical formalism, a considerable difference is seen here between the students who have physics as a major and the ones who have it as a minor.

Flux: It is noticeable that almost all students used the calculus representation of the flux and Gauss' law ($\oint \vec{E} \cdot \hat{n} dA = Q / \epsilon_0$). However, only one was really able to make sense of the mathematics. Most of them just defined flux as an integral but were not able to reason within the formalism. In fact, the mathematics of the flux conceptualization of the electrostatic field (SK3) is more abstract since it involves calculating an integral over a scalar product. In other words, it brings together both the idea of adding infinitesimals (integral) and considering the perpendicular component (scalar product).

In general, it is possible to observe a considerable difference between major and minor students regarding the quality of their explanations. Even though many of the minor students have mathematics as a major subject, it seems that they are not able to use the math in a meaningful way in a physics context.

The CSEM test is often used for assessing students' conceptual understanding in the area of electromagnetism. When comparing the CSEM pre-test scores and the level of explanations of students, it can be seen that those students with high CSEM scores (>15) were more likely to provide mathematically more meaningful explanations (students 2, 4, 5, 11, 13, and 13). However, there are three students with lower CSEM scores (1, 3, and 6), who also provided better quality explanations. In addition, two students with high CSEM scores (7, 12) were not able to justify their explanations in mathematically meaningful way. Therefore, the knowledge that the students possess does not mean that they are able to apply it in their justifications. When comparing the pre- and post-test scores and the quality of explanations, there are three students with level one justifications (10, 15, and 16), whose test scores have improved. This means that although their justifications are lower quality, they learn content knowledge while doing the concept network of electric field.

7. Conclusions and Perspectives

In this work we categorized the kind of mathematical representations used by physics teacher students to define central concepts of electrostatics. Moreover, we analysed the quality of their justifications for using certain mathematical structures to model physical situations. The results show that mere mastering of mathematics is not enough when it comes to reason with it in physical situations. Clearly context-dependent practice is needed, as can be seen from the better quality of explanations given by the physics major students. When the mathematical formalism is abstract (e.g. Flux), it is more challenging for students to reason and explain.

The next step of this research is to take a closer look at the concept networks made by the students and analyze deeply the nature of links between the nodes representing essential concepts. We expect to find considerable differences between the structure of these networks depending both on the mathematical representations used as well as on the quality of justifications.

Acknowledgments

We thank Dr. Maija Nousiainen for providing us the data from the course “Concept Formation of Physics II”, spring 2013. This work was partly supported by the Academy of Finland (TM - Grant SA257400) and the Alexander von Humboldt Foundation (RK - Grant BRA 1146348 STP).

References

- Feynman, R. P., Leighton, R. B., & Sands, M. (1964). *The Feynman lectures on physics* (Vol. 2). Reading, MA: Addison-Wesley.
- Koponen, I. T., Mäntylä, T., and Lavonen, J. (2004). The role of physics departments in developing student teachers' expertise in teaching physics, *European Journal of Physics* **25**, 645–653.
- Maloney, D. P., O’Kuma, T. L., Hieggelke, C. J., Van Heuvelen, A. (2001). Surveying students’ conceptual knowledge of electricity and magnetism. *American Journal of Physics* **69**, S12–S23.
- Mäntylä, T., and Koponen, I. T. (2007). Understanding the role of measurements in creating physical quantities: a case study of learning to quantify temperature in physics teacher education, *Science & Education* **16**, 291–311.
- Mäntylä, T., and Nousiainen, M. (2014). Consolidating Pre-service Physics Teachers’ Subject Matter Knowledge Using Didactical Reconstructions, *Science & Education* **23**(8), 1583–1604.
- Nousiainen, M. (2013). Coherence of Pre-service Physics Teachers’ Views of the Relatedness of Physics Concept, *Science & Education* **22**(3), 505–525.

Affiliation and address information

Ricardo Karam
University of Copenhagen
Department of Science Education
Øster Voldgade 3
DK-1350 Copenhagen K
Denmark
E-mail: ricardo.karam@ind.ku.dk

Terhi Mäntylä
University of Tampere
School of Education
Åkerlundinkatu 5
FI-33014 Tampere
Finland
E-mail: terhi.mantyla@uta.fi

Understanding and Explaining Equations for Physics Teaching¹

Ricardo Karam¹, Olaf Krey²

¹ University of Copenhagen, Denmark

² Martin Luther University Halle-Wittenberg, Germany

Abstract

In this work, we describe the structure of a course that was given to physics teacher students at the end of their master's degree at a German University. The course was designed to provide opportunities for students to learn about the interplay between mathematics and physics from a historical and philosophical perspective as well as to expand students' repertoire of explanations regarding possible ways to derive certain school relevant equations. The course design was evaluated with a multi method approach. Here we offer a first impression of how this course was perceived by our students and in what regards they were able to benefit from it. It seems encouraging that, based on a case study, our course was able to help students to change their conceptions about the role of equations as intended.

Keywords

Equations, mathematics, physics, interplay, physics teacher education

1. Introduction, motivation and background

Students often regard physics equations as calculation tools into which numbers are “plugged in” and answers are “chugged out”. In fact, this is a widespread approach found both in research and practice. This instrumental view has been identified in the literature as recursive plug-and-chug (Tuminaro & Redish, 2007), plug-and-chug unstructured (Walsh et al., 2007), calculation framing (Bing & Redish, 2009), technical dimension (Uhden et al., 2012), formulas epistemological beliefs (Hammer, 1994), fixation with formulas (Schecker, 1985), among others. The list of complains about this student behaviour is endless and the problem that comes with it – a lack of conceptual understanding and inadequate strategies in problem solving are well known. You could say physics is caricatured by the use of equations in typical “given-sought” tasks demanding little more than mere calculation skills identified in previous work.

The fact that this seems to be the general way of applying equations in physics seems to be problematic. The same goes for how equations are often introduced in our physics classrooms. It is not unusual to find a naïve inductive approach in which equations are treated as descriptions of empirical regularities. The passage from experimental data to the algebraic expression is often presented as trivial, despite the major epistemological incompatibility of these two domains (Falk, 1990).

Fundamental ideas, principles and laws in physics are often stated in an algebraic way, usually as equations. One of the essential characteristics of a physics expert therefore is to make sense out of, to *understand* these equations. But what exactly does it mean to understand an equation? Some research is available grounded in different theoretical frameworks, each of them offering an interesting perspective to get a better grasp on what understanding equations includes.

2. Understanding equations

Vom Hofe (1995), a mathematics educator, develops a concept called “Grundvorstellung” (“basic conceptions” or “basic notions”, for a lack of a better description). His approach is very similar to the more widely known concept of *symbolic forms* as proposed by Sherin (2000). He sustains that students can understand equations by bringing together rather sensorial meaning and formal operations into a conceptual schema, which again is associated to a symbolic pattern. Two examples are: the physical notion of *balancing* (symbol pattern $\square=\square$), often found in equilibrium situations, the more general idea of *competing terms* ($\square\pm\square\pm\square\dots$), commonly present in problems involving directed quantities like forces. Another perspective of “understanding equations” is found in the work of Bagno et al. (2008). Based on the multiple task view regarding understanding (Perkins & Blythe, 1994), the authors argue that students can demonstrate their

¹ For more details about this research, please see our article published in Science & Education 2015.

understanding of a formula by performing several activities related to it, such as presenting an association map of the formula, describing its components with their own words, identifying special cases, applying it in problem solving, among others. Other studies have investigated students' views on what it means to understand a physics equation. Domert et al. (2007) and Hechter (2010) interviewed university and high school students and categorized their answers into certain *epistemological mindsets* that range from the superficial identification of descriptive aspects (e.g. recognize the symbols of the equation) to a more theoretical understanding (e.g. recognize the underlying physics of the equation or its structure). Hechter's categories are similar but entail a different view of what understanding equations means. He emphasizes that understanding is a polysemic and subjective notion and that physics educators should make efforts to teach all "kinds of understanding".

Compared to the mentioned approaches, our proposal is more specific, since from an epistemological perspective, an equation may have quite different roles. Thus, we propose an overall *epistemological categorization of equations*, which involves different views on their epistemological nature. Although this categorization is built on theoretical ground and not a result of the analysis of empirical data, we argue that it allows classifying one's conception about the origin of a particular equation, based on one's answers to questions like: Where does the equation come from? What does it represent? Why is it expressed in this way? Our proposal is to classify the subjective epistemological status of equations into the following categories: 1) principles (e.g. $\Sigma \vec{p} = 0$ and $\delta S = 0$), 2) definitions (e.g. $\vec{v} = d\vec{r} / dt$ and $\vec{p} = m\vec{v}$), 3) empirical

regularities (e.g. Balmer's formula), 4) derivations (e.g. $a = v^2 / r$ and $E = mc^2$). Thus, we argue that the "understanding equations" issue must be considered separately in each specific case (category). Furthermore, being aware of this distinction seems crucial, since ways to explain a certain equation - and to structure lessons to teach it - may depend strongly on its epistemological character. *Principles* can be presented as plausible truths confirmed by observations and experiments; *definitions* need to be somehow justified concerning the needs to conceive particular physical quantities; *empirical regularities* are normally clarified by performing experiments; whereas equations resulting from *derivations* should be explained by formal deductions showing how they can be obtained from general principles and/or definitions. It is important to stress, however, that this is not to be thought as a strict set of mutually exclusive categories, due to the intrinsic flexibility of theoretical constructs and the changes in the epistemological status of equations through history (e.g. Kepler's laws shifted from category 3 to 4). In this work we focus on equations that can be conceptualized as derivations (category 4). For those equations (e.g. $a = v^2 / r$) we would expect and find it quite natural (indeed desirable) if a learner would sooner or later ask questions like *Why* does this formula have this particular structure? *Why* is the v squared, but not r ? *Why* is r the denominator, not v or v^2 ?

To answer these questions the inductive approach (doing experiments that more or less directly lead to this equation) might be one way to superficially satisfy our curiosity. However, as Feynman (1964, p. 26, our emphasis) puts it: „In the further development of science, we want more than just a formula [...] *the real glory of science is that we can find a way of thinking such that the law is evident.*“ When trying to define what is a physical explanation, Rivadulla (2005, p. 166) stresses that "any physical construct can only receive a theoretical explanation when it can be deduced mathematically in the framework of another physical construct of higher level". In physics education, this kind of understanding is hardly assessed by the standard view of equations as calculation tools to solve quantitative problems or as regularities extracted from experiments. Thus, highlighting this *explanatory* role of mathematical reasoning in physics is the first goal of the course designed to pre-service teachers. Achieving this goal, we believe, would not only enhance the content matter knowledge of our students, but also increase their awareness about the nature of physics and the role of mathematics.

However, if considered from a didactical perspective, the issue of approaching the explanatory role of equations in teaching is far from being trivial. Usually most students are not able to understand every step of such a deduction at once, either simply because it is a very demanding process or perhaps even because some mathematical knowledge is not available yet. In these cases a teacher's *explanations repertoire* is needed. In fact, this is one of the most important components of what Shulman called Pedagogical Content Knowledge (PCK). According to him "PCK includes the most useful forms of representation, [...] analogies, illustrations, examples, and demonstrations [...] Since there are no single most powerful forms of representation, *the teacher must have at hand a veritable armamentarium of alternative forms of representations*" (Shulman, 1986, p. 9, our emphasis). Quite often, different representation are grounded in different approaches that involve starting from different physical assumptions, using various models and

mathematical structures. We wish to stress the importance of knowing how to do this in several ways. Similarly, after presenting an alternative derivation of the kinetic theory of gases, Pfeffer concludes: “Apart from the novelty and the challenge of the intellectual exercise involved, *each approach gives different insights* and, when taken together, they serve to *deepen the students’ appreciation* of the subject” (Pfeffer, 1999, p. 237, our emphasis).

3. Course description

The course under consideration here was given to 13 physics teacher students at the Technical University of Dresden in Nov-Dec 2013. This version of the course is an improved version of earlier courses conducted at the University of Hamburg and the University of Helsinki.

The course structure reflects our two major goals, namely to 1) *epistemologically* recognize the explanatory role of mathematics in physics by means of derivation of equations and 2) *didactically* acquire a broad repertoire to explain (derive) relevant equations of secondary level physics. The 6 meetings (3 h each) were divided into a theoretical part (2 x 3 h) – in which historical and philosophical aspects of the relationship between physics and mathematics were approached – and a more practical one (4 x 3 h) – where four different equations and possible derivations were presented (one per session) and discussed. The equations under consideration were 1) free fall: $s = gt^2 / 2$, 2) centripetal acceleration: $a = v^2 / r$, 3) period of a simple pendulum: $T = 2\pi\sqrt{l/g}$ and 4) Snell’s law of refraction: $\sin\theta_1 / \sin\theta_2 = v_1 / v_2$.

During the first two sessions we were mainly concerned with a) consequences of the mathematization during the history of physics on a social, epistemological and ontological level as outlined by Gringas (2001), b) significance of basics mathematical conceptions (multiplication, functions, real and complex numbers) as discussed by Bochner (1963) or Falk (1990) and c) the role of mathematics in physics: mathematics as a language, physical explanations through mathematical deduction, diverse mathematical formulations of the same phenomenon.

Considering the focus of this paper on understanding and explaining equations, we will provide a more detailed description of the practical part, in which four equations typically taught in high-school level were approached. In each meeting, the class was divided into groups that received different ways to explain (derive) the equation, based on different lines of argumentation, mathematical formalisms, physical models, etc. Each group had the task of presenting their explanation to the whole class, as if it were a high school lesson (micro teaching). After each presentation, the lecturer moderated a discussion with the whole group concerning pros and cons of the explanation, such as typical difficulties faced by students, mathematical prerequisites, curricular constrains, etc. Additionally, a brief overview of the historical development of the equation was presented. The idea will be illustrated using the case of centripetal acceleration.

4. Example case study – centripetal acceleration

The fact that a uniform circular motion is accelerated already poses a major difficulty for students and is well documented in the literature (e.g. Viennot, 1979; Clement, 1982; Hestenes et al., 1992; Galili & Bar, 1992). But the centripetal acceleration equation ($a = v^2 / r$) carries a deeper mystery: Where does the v^2 come from? There are numerous ways to obtain this equation and the ones approached in the course were:

Group A) vector difference – similar triangles

This derivation is commonly found in high school textbooks. A material point moves in uniform circular motion. The positions (r_1 and r_2) and velocities (v_1 and v_2) are vectors separated by an infinitesimal time interval (see Figure 1a). This assumption enables one to make the approximation that the point’s displacement is a line segment and the desired equation is obtained by triangle similarity ($\Delta OAB \sim \Delta BCD$ – see Figure 15):

$$\frac{dr}{r} = \frac{dv}{v} \quad \therefore \quad \frac{vdt}{r} = \frac{dv}{v} \quad \therefore \quad \frac{dv}{dt} = \frac{v^2}{r} \quad \therefore \quad a = \frac{v^2}{r}$$

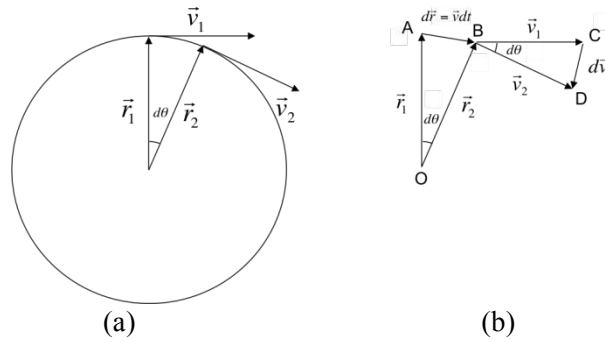

Figure 15 Point mass in uniform circular motion.

Although the mathematics needed for this derivation is quite simple, its physical interpretation is far from being trivial. The biggest problem seems to be the conciliation of two very abstract ideas, namely vector subtraction ($\vec{v}_2 - \vec{v}_1$) and infinitesimal increase ($d\theta, dr, dv$). This is especially complicated when one tries to draw infinitesimal triangles that exist only in our minds. During the course, students reported that they became more aware of many of these difficulties after thinking carefully about this derivation and facing the challenge of explaining it to the whole class.

Group B) analogical circles

Velocity is the rate of change of position. Acceleration is the rate of change of velocity. In a uniform circular motion, velocity is always perpendicular to position whereas acceleration is always perpendicular to velocity. These similarities lead to an astonishingly simple derivation of the centripetal acceleration equation (Wedemeyer, 1993). The whole argument is based on the fact that the three vectors involved ($\vec{r}, \vec{v}, \vec{a}$) take the same time to complete one revolution (see Figure 16).

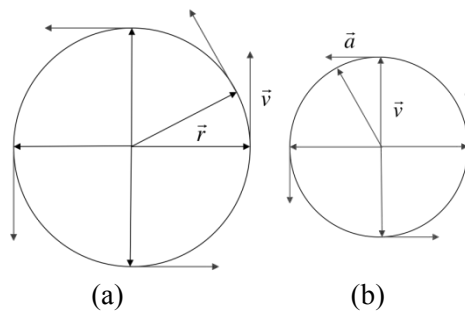

Figure 16 Point mass in uniform circular motion.

The period of the left circle (2a) is $T = 2\pi r / v$ and of the right circle (2b) $T = 2\pi v / a$. Since they are equal $2\pi r / v = 2\pi v / a$ it follows $a = v^2 / r$. If one represents the analogy between the vectors mathematically, there is actually no need to consider revolution periods: $v/r = a/v \therefore a = v^2 / r$. This derivation has the advantage of being extremely simple and stresses the formal analogy between velocity and acceleration. However, the downside is that circle 2b can be rather abstract for students, since it is represented in velocity space.

There were two more possible derivations given to the students. Group C was assigned to “Moon’s constant fall towards the Earth”, which involves considering the Moon’s orbit and analysing its movement if the Earth were to vanish (Gamow, 1962; Corrao, 2012). Group D was assigned to “Infinite collisions”, an approach that goes back to Newton, who modeled circular motion by considering elastic collisions inside a circle (Newton & Henry, 2000). Depending on the speed and angle with which the particle collides, regular polygons are obtained. The circle is achieved through an ad infinitum argument. Due to geometrical arguments, it is possible to justify why the force (acceleration) acting on the particle during each collision points to the center (centripetal). Students appreciated the “concreteness” of this derivation, but criticized its mathematical complexity.

5. Research Design

The methods used were systematically chosen and combined to answer our research questions. The one we are focusing on in this paper is: In what regard are students' conceptions on a) the relationship between physics and mathematics and b) the role of equations and their derivations in physics lessons, affected after the course? To answer these questions, we used a *pre-post-design* (questionnaire and mind maps for each of the equations), but also gathered *process data* by asking the students to write a course diary (at the end of each session (mandatory) and at home (voluntary)), conducting interviews with four students before, in between and after the equation based group work, and videotaping each session.

6. Results and Discussion

For the purpose of this paper we illustrate our findings based on a case study. Our student "Michael" is 23 years old. He is studying to become a physics and history teacher, and took advanced courses in Physics and German in high school. On a 1-5 scale, he finds experimental physics interesting (4), whereas theoretical physics less interesting (2). He chose physics as one of his teaching disciplines because he believes a science teacher can easily get a job and he is more interested in physics than in biology or chemistry.

Physics, mathematics and the interplay

In his pre-questionnaire Michael assigns a rather positive and phenomenological function for physics when he defines it as "the study of nature". For him, this science "describes natural phenomena", makes them "useful for humans" and offers knowledge that "protects us from danger". Only after emphasizing its utilization and application for human welfare he also points to a human desire to know/understand, when he states that "physics offers infinite knowledge about inner processes of the universe". As to mathematics, he regards it initially as a "useful tool" to "categorize, structure and measure the world" and stresses that "there is no modern science without mathematics". However, a rather negative view is perceived in many of Michael's answers, e.g. when he states that "mathematics brings students to despair and is responsible for many family conflicts". Overall, we perceive that he ascribes a rather negative emotional connotation to mathematics, usually referring to its authoritarian nature. This posture was confirmed not only in his written material, but also in the seminar videos and interviews. Concerning the role of mathematics in physics, Michael states that the former enables a "precise description of phenomena" and allows to "standardize or generalize measurement data". For him, measurement data are the starting point of theoretical work, since they are close to the actual phenomenon. When asked to express the relationship between physics and mathematics metaphorically, Michael describes the importance of physics for mathematics by saying that the former is for the later like "the annoying little brother, who does not deserve much attention, but is meant to be dominated by means of axioms, equations and theories". Michael clearly perceives a dominating role of mathematics and is emotionally attached to his statements. This goes well with what he writes to describe the role of mathematics in physics. In his words, mathematics is for physics "the eternal twin, a foothold to study nature, without which it is impossible to get along". Moreover, mathematics is like "a cage in which any form and beauty is imprisoned due to its precision and exactness". This seems to imply that for him mathematics has some sort of imposed (unjustified or even threatening) authority.

Considerable differences were found in Michael's post-questionnaire. The most significant is the absence of negative connotations regarding mathematics. When expressing his view on the role of mathematics in physics he now writes that the former is useful in "describing, stating more precisely and generalizing natural phenomena", that it "supports a better understanding of different theories", "expands our knowledge" and "provides a universal language to better comprehend [...] nature". The metaphors used to describe the interplay also changed considerably: mathematics is for physics "like a language that categorizes natural phenomena and provides a general construct that allows to generate new knowledge" and physics is for mathematics like "a possibility to confirm theories and concepts in the real world". Michael is aware of the fact that his view has changed significantly. In Interview 3 he states: "A lot has changed here." (7:20) and later he also jokes "I have been enlightened"(15:25). On the other hand he is not brain washed and states that he still holds his initial view "a little" (8:20). However, during the seminar he made experiences and gained insights that he didn't have before. "To deal with mathematics [short pause] – it can be fun. This is something I realized" (8:30-8:45). The physical reality and the phenomena are the core of his view of physics and experimental data still remain crucial in his theorizing. However the line of thought sometimes changes direction, e.g. when he states that "mathematics can help to explain a phenomenon" and in regards to Snell's law "Mathematics provides a construct that helps to conclusively describe the situation" (10:00). There are also signs that point towards a view of mathematics in physics as a structuring instrument: "To

summarize different aspects of nature in the language of mathematics and to better connect ideas to generate new knowledge” (10:45).

Considering the pre-post comparison and the reasons given by Michael in the interviews, it seems that the course had an impact on his general conceptions about mathematics, physics and their interplay. Moreover, Michael himself is aware of major shifts in his perception of the role of mathematics in physics. Most remarkable is the fact that, at least directly after the invention, there is not only a cognitive change perceivable, but also an emotional one.

Explaining $a = v^2 / r$ in a physics lesson

When asked to outline a lesson in which the equation for the centripetal acceleration ($a = v^2 / r$) should be explained, the emphasis on description and application is rather evident in Michael’s plan. For him, it is important to “explain the meaning of each of the equation’s symbols”, situate “contexts of application” (such as carousel, curves) and “discuss the use of the formula”. The focus on description and application is again expressed in the four steps of the proposed teaching sequence: 1) identify and explain the meaning of each of the equation’s symbols; 2) make hypotheses concerning the change in one magnitude caused by the change in others; 3) describe the equation with the help of pictorial representations and examples; 4) discuss applications in everyday life. When asked to answer one student’s question (Why is the equation like this?) Michael presents the following deduction:

$$a = \frac{v}{t} \wedge t = \frac{s}{v} \Rightarrow a = \frac{v}{(s/v)} = \frac{v^2}{s} \Rightarrow a = \frac{v^2}{r} \text{ where } s \text{ was substituted for } r.$$

The confirmative role that Michael addresses to formal deductions is evident in this derivation, in which a series of manipulations is performed without an attempt to make sense of the steps taken. This leads him to accept a desired conclusion based on inappropriate and even contradictory assumptions.

A very different teaching proposal designed to explain the centripetal acceleration formula is found in Michael’s post-test. Already the goals have changed significantly. He now says that students should be able to “explain why v^2 , why $1/r$, why the acceleration points to the center and understand one derivation of the formula”. His new lesson plan is the following: 1) present a case in which the centripetal acceleration appears (e.g., the orbital motion of the moon around the Earth); 2) sketch the problem pictorially (What would happen if the Earth was not there?); 3) deriving the equation using the Pythagorean theorem (group C); 4) a is directed to the center: visualization through the direction of the gravitational force pointed to the Earth. He justifies his choices by saying that “it seems important to show students where this equation comes from. With a visual sketch of the problem it becomes clear what equations are needed to derive this new equation. Additionally, one can present other derivations that are more geometrical. Thus, pictorial representations and language go hand in hand, which is more meaningful according to learning psychology”. The hypothetic student’s question (Why is the equation like this?) is now answered with the schematic representations of three different deductions (groups A, B and C).

Understanding equations

When asked to express the necessary conditions for him to be satisfied with his understanding of a particular formula in the first questionnaire, Michael says he “must know where the formula comes from, how it was originated and be able to explain it with everyday life examples.” A significant change is also noticed in Michael’s description of what it means to understand an equation. In the post-questionnaire he now clearly states that an equation is fully understood when he has “no problem in deriving it in many different ways” and is able to “explain and understand the origin of its terms”. The positive role attributed to the derivation of the formula is again highlighted when he states that “it is only possible to really grasp an equation when one fully understands its derivation”. This substantial modification is confirmed in his new answer to the item 3 “In physics, the deduction of a particular formula only confirms that it is ok to use it” (strong agreement (4) in the pre-test to slight disagreement (2) in the post-test).

In the interviews, Michael repeatedly addressed a crucial role to one particular derivation of the centripetal acceleration equation (group C) when he justifies most of the differences in his answers in the pre-post comparison. However, he does not seem to have had such a meaningful experience with the other equations approached in the course. It certainly is not a coincidence that Michael was a member of group C and was responsible for the presentation of this particular derivation. He was certainly looking into this derivation more carefully and more deeply than in any of the others.

When asked for his most important gain from this course he said: “We often asked ourselves: What is actually behind this formula? The most important thing was to **learn to ask these questions** [our emphasis]; where does this and that come from? Derivations are very important for this purpose [...] My favourite formula is now the centripetal acceleration: I know where it comes from, I know what is behind it and I can derive it in a meaningful way. And that is when we really understand a formula. [...] A lot is happening when we derive a formula – considering examples, special cases etc.” (Int 3 - 20:55- 21:20)

7. Discussion

Michaels case illustrates, that ideas about the role of mathematics can be changed. Apparently it is an important ingredient to base the discussion on concrete ground, e.g. a specific equation “well known” to the students. At least Michael’s arguments and reflections always go back to specific experiences, not general descriptions of philosophical or epistemological considerations (as discussed in the first part of the course). It seems rather indispensable to engage students in the struggle of understanding the derivations and to give them enough time (in our case one week) to prepare their explanations to the whole class (micro teaching). This provides an authentic learning experience and makes them aware of the difficulties that can be faced by their students.

This work was motivated by our impression that a structural role of mathematics in physics is not adequately represented in our teachers’ (students’) conceptions and/or teaching routines. In order to contribute to an effort that aims at going beyond “plug & chug” or the “inductive perspective”, we designed, applied and evaluated an original course to physics teacher students. We hope to have offered an initial proposal to be further improved and to have increased the interest of physics educators in integrating similar approaches into teacher education.

References

- Bagno, E., Berger, H., Eylon, BS. (2008). Meeting the challenge of students’ understanding of formulae in high- school physics: a learning tool. *Physics Education* **43**(1), 75-82.
- Bing, T. & Redish, E. F. (2009) Analyzing problem solving using math in physics: Epistemological framing via warrants. *Phys. Rev. ST Phys. Educ. Res.* **5**, 020108.
- Bochner, S. (1963). The Significance of Some Basic Mathematical Conceptions for Physics. *Isis*, **54** (2):179-205.
- Clement, J.: 1982, Student Preconceptions in Introductory Mechanics. *AJP* **50**: 66- 71.
- Corrao, C. (2012): Gamow on Newton: Another Look at Centripetal Acceleration. *The Physics Teacher*, **50**(3), 176.
- Domert, D., Airey, J., Linder, C., Kung, R.L. (2007). An exploration of university physics students’ epistemological mindsets towards the understanding of physics equations. *NorDiNa* **3**(1):15-28.
- Einstein, A. (1956). *Mein Weltbild*. Frankfurt: Ullstein Tachenbücher-Verlag.
- Falk, G. (1990). *Physik: Zahl und Realität. Die begrifflichen und mathematischen Grundlagen einer universellen quantitativen Naturbeschreibung*. Basel: Birkhäuser Verlag.
- Feynman, R.P., Leighton R.B., Sands M. (1964). *The Feynman Lectures on Physics*. Addison-Wesley, Reading, MA.
- Gamow, G. (1962). *Gravity*. London: Heinemann Educational Books.
- Gingras, Y. (2001). What did mathematics do to physics? *History of Science* **39**:383-416.
- Hammer, D. (1994). Epistemological beliefs in introductory physics. *Cognition and Instruction*, **12**: 151-183.
- Hechter, R.P. (2010). What does “I understand the equation” really mean? *Physics Education* **45**, 132.
- Hestenes, D., Wells, M., & Swackhamer, G. (1992). Force concept inventory. *The Physics Teacher*, **30**(3), 141-158.
- Hofe, R. V. (1995). *Grundvorstellungen mathematischer Inhalte*. Heidelberg: Spektrum Verlag.
- Lakoff, G. & Nunez, R. E. (2000). *Where Mathematics Comes from*. New York.
- Newton, I.; Henry, R. C. (2000): Circular motion. *American Journal of Physics*, **68**(7), 637-639.
- Perkins, D.; Blythe, T. (1994): Putting Understanding Up Front. *Educational Leadership*, **51**(5), 4-7.

- Pfeffer, J.I. (1999). An alternative derivation of the kinetic theory of gases. *Physics Education* **34**(4):237-
- Rivadulla, A. (2005) Theoretical explanations in mathematical physics. In: Boniolo, G.; Budinich, P.; Trobok, M. (eds): *The Role of Mathematics in Physical Sciences*, Springer, Dordrecht.161-178.
- Schecker, H. (1985) *Das Schülervorverständnis zur Mechanik*. Doctoral dissertation, University of Bremen.
- Sherin, B.L. (2001). How students understand physics equations. *Cognition and Instruction* **19**(4) 479-541.
- Shulman, L. (1986). Those Who Understand: Knowledge Growth in Teaching. *Educational Researcher*, **15**(2): 4-14.
- Tuminaro, J. & Redish, E. F. (2007). Elements of a cognitive model of physics problem solving: Epistemic games. *Phys. Rev. ST Phys. Educ. Res.* **3**, 020101.
- Viennot, L. (1979). Spontaneous reasoning in elementary dynamics. *EJSE*, **1**(2), 205-221.
- Wedemeyer, B. (1993). Centripetal Acceleration - A Simple Derivation. *The Physics Teacher* **31**(4): 238-39.

Affiliation and address information

Ricardo Karam
University of Copenhagen
Department of Science Education
Øster Voldgade 3
DK-1350 Copenhagen K, Denmark
e-mail: ricardo.karam@ind.ku.dk

Olaf Krey
Martin Luther University Halle-Wittenberg
Didaktik der Physik
Hoher Weg 8
06120 Halle/Saale, Germany
e-mail: olaf.krey@physik.uni-halle.de

Investigation of a Reflective Pedagogy to Encourage Pre-Service Physics Teachers to Explore Argumentation as an Aid to Conceptual Understanding

Greg Lancaster, Rebecca Cooper.

Science Education Research Group, Faculty of Education, Monash University, Australia.

Abstract

An emerging focus of recent science education research advocates the benefits of using argumentation as an approach in which teachers can better engage students in a more authentic experience of the epistemic work of scientists, (Bricker & Bell, 2008). Logical argument and critical thinking are considered essential skills for an effective and successful undertaking of scientific inquiry and analysis. Early research suggests the practise of encouraging students to engage in scientific discourse in the classroom (Kuhn, 2010) can provide rich experiences for students and teachers to hone their cognitive abilities. This paper explores the use of critical ‘discussion problems’ purposefully designed for pre-service physics teachers to investigate their own alternative conceptual understandings of key physics ideas. It also discusses how these problems are then used to generate classroom discourse which focuses on the importance of developing effective pedagogical content knowledge (See Shulman, 1986 for a detailed explanation of pedagogical content knowledge) rather than just mastery of scientific content and its mathematical applications. Further, the paper will detail a preliminary study in which pre-service physics teachers were introduced to a number of discussion problems via an online learning environment and asked to first consider the problem and post a solution in isolation from their peers. A considerable challenge was persuading the pre-service teachers to resist the common practice of ‘Googling the answer’ via the internet before posting their solution attempt. Although most students initially appeared to believe that posting ‘the correct’ answer was the main task objective, the vast majority eventually came to realise that discussing the range of unresearched solutions was much more beneficial for their conceptual understanding and professional practice. Over time, this approach generally encouraged students to post original ideas and to be less influenced by the arguments or analysis of other students.

Following the completion of the online posts, the range of ideas included in the postings were then explored during a face to face workshop where the ideas were debated and frequently defended and the implications for pedagogy and their students learning discussed. The initial feedback from the pre-service teachers during this preliminary study is encouraging and suggests there is merit in exploring the benefits of argumentation for pre-service teachers and their students in a subsequent expanded study.

Keywords

Argumentation, conceptual understanding, meta cognition

1. Introduction

Jerry Wellington and Jonathan Osborne in their book (Wellington & Osborne, 2001) on the use of language in science education, identify at the outset a fundamental premise which underpins their notion of what constitutes a quality science education. They view learning the language of science as a key objective (“if not *the* major part”, p2) of the purpose of science education. Further to this they propose that science educators should embrace the notion that “every science lesson is a language lesson”. It is during rhetorical communication that students are more likely to realise the strengths and shortcomings of their current science understandings (Bell & Linn, 2000). This view that students need to become proficient in their use of scientific language is an emerging focus of recent science education research (Duschl, & Osborne, 2002; Norris, & Phillips, 2003; Sampson & Clark 2008; Osborne, 2012;) and has provided impetus to the notion of

developing scientific literacy in all citizens to ensure that they are skilled sufficiently to fully participate in an increasingly technologically focused society.

Since the term scientific literacy was coined in the late 1950s it has remained nebulous and researchers have continued to struggle to achieve a widely accepted definition. Some fifty years after its emergence, Rüdiger Laugksch (Laugksch, 2000, p.71) in his comprehensive analysis of the term still described it as an “ill-defined and a diffuse concept”. Although the complexities of scientific literacy continue to be debated by researchers (Shamos, 1995; Bybee, 1997; Driver, Newton & Osborne, 2000) there are essential inquiry skills and knowledge about the nature of science and how it is undertaken which are increasingly seen by many educators as essential competences for a scientifically literate citizen. These competencies are important in order to equip citizens to make the scientifically informed and socially responsible decisions required to engage successfully in a 21st century world. Critical to the foundation of an understanding of scientific literacy is the knowledge of the social construction of science and the many practices and processes of science that inspire debate and disagreement from both within scientific communities, the media and the political arena. Being able to participate in logical debate, construct coherent arguments and appraise the arguments of others is an increasingly important skill. Hence, the skill of argumentation is seen by many science educational researchers as an essential component of a quality science education and further, the development of scientifically literate citizens.

2. What is argumentation?

Van Eemeren and Grootendorst (2004) define argumentation as “. . . a verbal, social, and rational activity aimed at convincing a reasonable critic of the acceptability of a standpoint by putting forward a constellation of propositions justifying or refuting the proposition expressed in the standpoint” (p. 1). This definition has met with wide acceptance however the use of the word ‘verbal’ is commonly associated with spoken language but can arguably be regarded to include written, graphical and mathematical communication. The term ‘social’ is particularly pertinent as the approach most frequently practiced (but not exclusively) is a dialogue between two or more people. Argumentation is also “rational” in that “it is aimed at defending a standpoint in such a way that it becomes acceptable to a critic who takes a reasonable attitude” (Van Eemeren, Grootendorst, & Henkemans, 2002, p.11). Initially, the use of the term ‘reasonable’ appears to lack the clarity one would aspire for however when one considers the very social nature of the task, what may be accepted as logical and reasonable by one person may remain confusing and unreasonable for another.

Van Eemersen and Gootendorst (2004) propose that argumentation is fundamentally different from other forms of discourse, such as instruction, explanation or clarification because argumentation includes the notion of a positional standpoint. They argue that other forms of discourse involve either an overt or covert mutual acceptance of key propositional ideas that are never disagreed with or challenged. Alternatively, the purpose of argumentation is to deliberately challenge or defend a standpoint whose correctness can eventually be agreed upon through use of a logical evidence based rhetorical argument. Although this distinction is seen as helpful by many, it has prompted some disagreement by those who see that explanation based discourse can also include disagreement and hence involve elements of argumentation as well, (Simosi, 2003).

In his influential work on the structural analysis of argument Stephen Toulmin (Toulmin, 1958) proposed a radically new framework (Fig 1.) that replaced the use of the traditional terminology of ‘premise’ and ‘conclusion’ with a new schema. His study of the way people argue in natural settings gave rise to a range of new terms such as; data, claim, warrant, rebuttal and backing. Firstly in his proposal the claim is equivalent to the conclusion whose merit is to be established by the claimant. The data is considered to be the evidence or facts that lay foundation to the claim to be established. The warrant is then used to bridge or link the data or evidence with the claim. If the warrant is not considered to be strongly convincing then an additional backing point is used to support or credential the warrant. In addition a qualifier can be used by the claimant to indicate the strength of their conviction or the degree of certainty with which they advocate the claim. A rebuttal is sometimes also used to qualify the claim in recognition of restrictions dependant on context. The claim (conclusion), data (evidence) and the warrant are considered to be essential elements of Toulmin’s framework. His approach attempts to decontextualise the process providing an analytical framework with which to argue rationally or scientifically. Although there have been many subsequent amendments proposed to Toulmin’s original work it continues to provide a framework which still provides a valid model today although a substantial limitation is that it does not lead to judgments about the correctness or quality of the argument. Assessments on the quality and correctness of an argument clearly demand expert content knowledge to gauge the validity of the data and its logical application within the context.

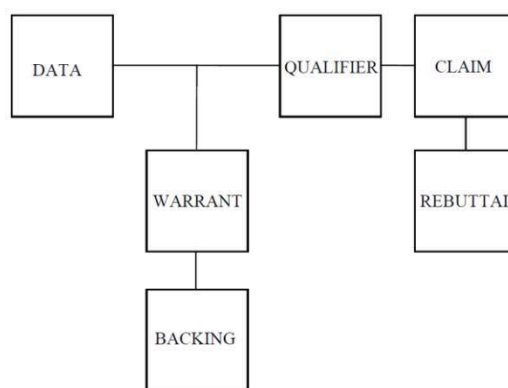

Figure 1. Toulmin's argument schema

3. Reported benefits

Effective argumentation is an approach that requires critical thinking, logical construction and evaluation of argument. Although these skills are by no means unique to the domain of science there is no doubt that they are critical to how the scientific community uses skilled scientific arguments to support or challenge the creation of new knowledge and to logically scrutinise the merit of evidence with peers. An increasing number of science educators now view argumentation as an important instructional approach that provides science students with authentic opportunities to investigate how scientists use skilled scientific arguments to undertake the social construction and consolidation of new knowledge; the core epistemic work of scientists (Bricker & Bell, 2008). Previous classroom research has shown that teacher intended student classroom discourse occupies very little class time. Findings in the US from Goodlad (1984), found that open discussion occupied an average of 4-7% of total class time. This compares similarly with more recent research in 1997 in the UK by Newton et al. (1999), where their study of 34 lessons revealed that on average 2% or less of class time was spent on student collaborative discussion. With the growing adoption of inquiry based learning and the use of collaborative practical investigations one would be hopeful that these numbers have increased in recent times. However, they do highlight how important it is that greater attention is given to the processes of planning, analysis and interpretation with argumentation being acknowledged as an integral part of these processes (Kuhn & Pease, 2008).

As a consequence of her extensive research in this area, Deanna Kuhn (1991, 2010) concludes that providing opportunities for students to engage in scientific discourse in the classroom can provide rich authentic experiences for students and teachers to engage in scientific reasoning and the construction and analysis of logical argument. In one study she explored the capacity of 160 individuals ranging from primary school students to adults to use reasoned argument when considering problematic social issues. Her findings suggest that both children and adults (particularly those with limited formal education) were very poor at co-ordinating and constructing the essential relationships between, Toulmin's 'data' (evidence) and 'claim' (conclusion) for a logically reasoned argument. She advocates that students need to be taught that 'data' (evidence) is qualitatively different from theory and that evidence is critical in supporting or disproving a theory.

Kuhn and Reiser's (2005) findings have been cited as evidence by many education researchers that the majority of people struggle to demonstrate effective argumentation skills and that students should be provided with more opportunities to engage in the construction and analysis of reasoned arguments. Teaching science using an argumentation frame is seen by many educators as an essential approach with which to engage students in an experience of science more representative of the formal cognitive work undertaken by scientists.

4. Research methodology

Given the potential benefits of an argumentation framework as highlighted in the literature, the researchers were keen to explore how the practice of argumentation could be introduced to pre-service physics teachers and the potential benefits explored within the tight time constraints of a teacher education course. The approach trialled was to establish a small pilot study during a second semester unit and to introduce the ideas on multiple occasions rather than a single workshop. It was anticipated that revisiting the ideas would create opportunities to progressively develop the notion of argumentation and to gauge the effectiveness of the approach in shaping the thinking and professional practice of pre-service science teachers.

Four purposefully designed ‘discussion problems’ were introduced using an online discussion forum in which the pre-service teachers ($N=23$) could post brief solutions (~150 words) with an accompanying argument. This forum would also provide the pre-service teachers with data for a meta-analysis of their alternative conceptual understandings of the ‘key’ physics ideas underpinning the problems and provide an opportunity to make the different understandings of their peers more explicit. After posting their solution online, the discussion problem and the range of views were then discussed in subsequent face to face workshops conducted the following week. During these workshops individuals were invited to discuss, defend and argue the merits of their solutions with the collective intent of arriving at an explanation acceptable to all. It was envisaged that these workshops would provide an opportunity for the pre-service teachers to explore the benefits of argumentation in achieving both rational solutions to the problems using a dialogic process and to clarify each other’s conceptual understanding of the key physics ideas. This approach would also introduce a collegial learning model and encourage the investigation of related pedagogies which they may choose to explore further in their own practicum experiences.

The online discussion forum was established using a Moodle (Virtual Learning Environment) and required the pre-service teachers to post their solutions to the forum before accessing those of their peers. This restriction was adopted by the researchers as it was felt that it would help create a low threat environment where the pre-service teachers were able to take the time they needed to formulate an individual considered response. It also encouraged every class member to undertake some degree of preliminary thinking about the problem before engaging in a dialogic analysis of the problem during the workshop debrief.

Experience with many past physics method pre-service teachers suggests that a high proportion are mature age and academically high performing (many possess post graduate or doctoral qualifications). Maybe more than most students, the physics graduates demonstrate a reluctance to be seen as ‘incorrect’ amongst their peers and lecturers, and so are frequently slow in volunteering possible solutions which they are unsure of, or opinions which they hold but know to be incorrect or inconsistent with the accepted scientific view. The pre-service teachers were instructed not to ‘Google’ or research problem solutions before posting their initial attempts because achieving the ‘correct’ answer was not the most beneficial outcome. It was explained to the pre-service teachers that their unresearched solutions were much more likely to provide insights into commonly held alternative conceptions and appropriate pedagogical approaches that could be used to shift their students towards an understanding consistent with the current scientific view.

Four qualitative discussion problems were initially designed to loosely target the Victorian state senior physics curriculum and provide a range in difficulty and context. Each problem although capable of numerical analysis did not require the students to provide more than a qualitative explanation of the solution with the possible addition of suitable evidence to support their thinking. However, in this pilot study students were deliberately given no instructions or models on how to compose or argue a convincing solution for their forum posts or for use in the face to face workshops.

5. Discussion Problems

Two of the four discussions problems used in the pilot study are included below with some analysis.

Discussion Problem (1) – Two connected balloons

Two balloons with similar properties are inflated to different diameters and connected by a short length of tube as shown below (Fig 2.). The tube is initially clamped tight to prevent any air flow but then released. Both balloons are free to expand or reduce to accommodate a change in volume as needed. Will there be any change in the balloons when the air is able to flow freely between them? Describe what will happen. What do you think your students would predict will happen and why?



Figure 2. Two connected balloons

Discussion Problem (2) – Weighing your finger in a glass of water

A beaker containing a small measure of water is placed on an electronic balance. The weight is recorded and a finger is lowered into the beaker until it is partially submerged but not touching the beaker as shown in figure 3 below. Will the weight of the beaker stay the same or change and if so how? Discuss how you arrive at your solution. What do you think your students would predict and why?



Figure 3. Weighing your finger in a glass of water

6. Preliminary findings and analysis of online posts

As stated, this research was undertaken in the form of a small pilot study consisting of just four discussion problems for use with 23 pre-service teachers. The anecdotal evidence used to gauge the impact of this approach is based on an analysis of 87 solutions posted to the online forum and the interpretation of the lively discourse generated during the four face to face workshops (approx. one hour of discussion in total) where the solutions were debated and defended by many of the pre-service teachers. In addition, the students were asked to complete written reflections on their learning at three points throughout the 12 week unit and many of these contained comments about their experiences with the problems. As a consequence of research ethics compliance, none of the pre-service teacher responses from the study will be quoted, however their general analysis by the researchers will be used to assess the impact of the argumentation approach trialled and to shape the design of a more qualitative research methodology for future study.

Discussion Problem (1) – Two connected balloons

The task was new and understandably many of the pre-service teachers described feeling unsure about the format of their online response. The average response was 160 words with 16 pre-service teachers posting correct and 10 posting incorrect solutions to the problem. Of the 16 correct solutions, 13 constructed arguments that were consistent with Toulmin's argument schema, in which they included a claim (e.g. the small balloon would reduce in size while the large balloon would increase), evidence (e.g. it is harder to blow up a small balloon because the internal pressure is higher than in a larger balloon) and a supporting warrant (e.g. identifying the Young-Laplace or Laplace's pressure equations for gas bubbles in a liquid) to construct their argument. All 10 incorrect proposals were poorly constructed with a tentative, incorrect or ambiguous claim. A number of these also attempted to use a warrant instead of evidence to support the claim or used a warrant which identified an alternate physics law which was not applicable to the context.

Discussion Problem (2) – Weighing your finger in a glass of water

Most pre-service teachers posted succinct online responses to the second problem. The average response was 136 words with 18 pre-service teachers posting correct solutions stating that the weight of the beaker increases, compared with just four posting incorrect or confused responses with no clear claim. The 18 correct solutions all appeared to reflect reasoning consistent with Toulmin's argument schema and many showed greater attention to the choice of relevant evidence (e.g. identifying the existence of reaction forces) and relevant warrants (e.g. buoyancy forces, Archimedes principle or Newton's third law) compared with the previous problem. The majority of solutions were better constructed and argued than in the previous problem with a higher proportion achieving a correct solution compared with the first problem. This improvement may reflect a problem which is less counterintuitive than the first or it may be more likely the result of improved efforts to research the answer in an attempt to ensure an improved chance of a correct solution. A small number of the pre-service teachers admitted to investigating the solution at home using kitchen scales and a glass of water to explore the answer before attempting the online posting.

7. Preliminary findings – analysis of workshops and reflective comments

The vast majority of pre-service teachers reported finding the problems highly engaging and they particularly welcomed the opportunity for a follow up face-to-face workshop to debate the range of alternate arguments posted online. Several pre-service teachers described the discussion problems and their analysis as one of the highlights of the unit with more than half the cohort acknowledging their benefits in their reflective comments. No negative comments regarding their use were recorded and only a few students remained ambivalent to their inclusion in the unit. Anecdotal comments made during the workshops suggested that many of the pre-service teachers admitted to undertaking some cursory internet research to investigate the problems before posting their solutions to ensure their attempted answers were “on track”. Given the nature of ubiquitous Wi-Fi and easy access to mobile devices it remains unclear how this form of investigation could be completely discouraged other than by rationalising the intent of the exercise as was attempted.

Approximately half of the pre-service teachers acknowledged in their reflective comments the benefits of the workshop discussion in making explicit the range of alternative conceptions relevant to the problem contexts. Many reported that they felt these insights would enable them to make better informed pedagogical choices and equip them to more skilfully address the range of alternate views likely to be encountered in their classrooms. Some pre-service teachers recounted how they had introduced some of the problems into their practicum classrooms where they had caused considerable debate and discussion to the interest of their teacher mentors. The comments and feedback from the pre-service teachers suggests that the face-to-face workshops were instrumental in providing them with highly interactive forums in which they could construct logical arguments and verbally present them to their peers for critical comment. Several pre-service teachers reported that they welcomed the opportunity to test their thinking against the expert knowledge of other physics content specialists. Several pre-service teachers also remarked that their introduction to an argumentation framework was valuable and not something that they recall encountering during their undergraduate or post graduate studies in science.

The face to face workshops provided valuable opportunities for the pre-service teachers to present and refine ideas and develop their skills in the construction and critique of logical arguments. During the first two workshops the pre-service teachers were comfortable with contributing ideas and analysis in a general class discussion managed largely by one of the researchers. However, in the final two workshops, several individuals volunteered to present their solutions as a starting point for class critique and this learner centred approach appeared to generate engaging discussion resulting in more polished and logical argument development. Eventually, the vast majority of the class members appeared to be quite satisfied with the solutions, which were improved through a process of class consensus.

8. Conclusions and opportunities for further research

The preliminary findings suggest that the use of discussion problems can act as a positive stimulus for pre-service science teachers to consider the merits of adopting an argumentation framework in their professional practice. In addition, the careful choice of suitable problems can promote considerable debate and assist pre-service teachers to reflect on the potential range of alternative conceptions they are likely to encounter among their students for specific physics contexts. Equally important for the preparation of skilled science teachers is the development of their pedagogical content knowledge and a growing awareness of how skilled pedagogical choices can successfully challenge and shift their students’ understanding to better reflect the current scientific explanation. Critical to the success of this approach is the fostering of trusting relationships within the class where pre-service teachers can feel at ease in sharing their alternate understandings with their peers without the pressure to always be seen as ‘correct’. Although the researchers acknowledge the limited nature of this pilot study, they are encouraged by the preliminary findings and suggest that an expanded investigation that considers alternate instructional approaches and the use of rich technology may better promote the use of productive argumentation in science classrooms.

References

- Bell, P., & Linn, M. (2000). Scientific arguments as learning artifacts: Designing for learning from the web with KIE, *International Journal of Science Education*, **22(8)**, 797-817.
- Bricker, L. A., & Bell, P. (2008). Conceptualizations of argumentation from science studies and the learning sciences and their implications for the practices of science education. *Science Education*, **92(3)**, 473-498.

- Bybee, R. W. (1997). *Achieving scientific literacy: From purposes to practices* (Vol. 88). Portsmouth, NH: Heinemann.
- Driver, R., Newton, P., & Osborne, J. (2000). Establishing the norms of scientific argumentation in classrooms, *Science Education*, **84**(3), 287-312.
- Duschl, R. A., & Osborne, J. (2002). Supporting and Promoting Argumentation Discourse in Science Education, *Studies in Science Education*, **38**, 39-72.
- Goodlad, J. L. (1984). *A place called school: Prospects for the future*, NY: McGraw-Hill.
- Kuhn, D. (2010). Teaching and learning science as argument, *Science Education*, **94**(5), 810-824.
- Kuhn, D. (1991). *The skills of argument*. Cambridge, UK: Cambridge University Press.
- Kuhn, L., & Reiser, B. (2005). Students constructing and defending evidence-based scientific explanations. *Annual meeting*, National Association for Research in Science Teaching, (NARST), Dallas, USA.
- Kuhn, D., & Pease, M. (2008). What needs to develop in the development of inquiry skills? *Cognition and Instruction*, **26**, 512-559.
- Laugksch, R., C. (2000). Scientific literacy: A conceptual overview, *Science Education*, **84**(1), 71-94.
- Newton, P., Driver, R. & Osborne, J. (1999). The place of argumentation in the pedagogy of school science, *International Journal of Science Education*, **21**(5), 553-576.
- Norris, S. P., & Phillips, L. M. (2003). How literacy in its fundamental sense is central to scientific literacy. *Science education*, **87**(2), 224-240.
- Osborne, J. (2012). Exploring the landscape of scientific literacy. *Studies in Science Education*, **48**(1), 119-123.
- Sampson, V., & Clark, D., B. (2008). Assessment of the ways students generate arguments in science education: Current perspectives and recommendations for future directions, *Science Education*, **92**(3), 447-472.
- Shamos, M., H. (1995). *The myth of scientific literacy*, New Brunswick, NJ, Rutgers University Press.
- Shulman, L. S. (1986) Those who understand: Knowledge growth in teaching, *Educational Researcher*, **15**(2), 4-14.
- Simosi, M. (2003). Using Toulmin's framework for the analysis of everyday argumentation: Some methodological considerations, *Argumentation*, **17**, 185 – 202.
- Toulmin, S. (1958). The layout of arguments. In Toulmin, S. (ed.), *The Uses of Argument*. Cambridge: Cambridge University Press, 94-145.
- Van Eemeren, F., H., & Grootendorst, R. (2004). *A systematic theory of argumentation: The pragma-dialectical approach*, (Vol. 14), Cambridge University Press.
- Van Eemeren, F., H., Grootendorst, R., & Henkemans, A., F., S. (2002). *Argumentation: Analysis, evaluation, presentation*, Routledge.
- Wellington, J., & Osborne, J. (2001). *Language and literacy in science education*, Buckingham, Open University Press, UK.

Affiliation and address information

Greg Lancaster & Rebecca Cooper,
Faculty of Education,
Monash University,
Clayton, Australia, 3800.
greg.lancaster@monash.edu ; rebecca.cooper@monash.edu

Towards a PCK of Physics and Mathematics Interplay

Yaron Lehavi^{1,2}, Esther Bagno², Bat-Sheva Eylon¹, Roni Mualem¹, Gesche Pospiech³, Ulrike Böhm, Olaf Krey, Ricardo Karam

¹ *Weizmann Institute of Science;*

² *The David Yellin Academic College of Education;*

³ *Technische Universität Dresden*

Abstract

The present study examined the intertwining of physics and mathematics within the context of physics teaching (Phys-Math interplay) through interviews conducted with experienced high school physics teachers from two countries. The teachers were asked about their views with regard to the importance of the topic at hand and to provide examples of how they address it in their teaching. The examples were categorized and fitted to an adopted theoretical PCK framework. Implications with regard to physics teaching were suggested.

Keywords:

Secondary education: upper (ages about 15-19), Physics and Mathematics Interplay, Physics Teachers, Teaching.

1. Introduction

The intertwining of physics and mathematics has a long history and was studied from the perspectives of history of science and its philosophy. Physics and mathematics are also heavily interwoven in learning physics at many levels. However, research indicates that learners, at different ages and levels, lack the ability to construct the mathematical models of physical processes or to describe the physical meaning of mathematical constructs. Clement et al. (1981) reported on the pitfalls freshman engineering majors encounter when asked to construct equations to match situations described in words. Bagno et al. (2007) carried out diagnostic studies showing that high-school students face difficulties describing the physical meaning of formulas. Cohen et al. (1983) found that both high school students and their teachers often fail in qualitative reasoning on DC circuits despite the fact that they are able to apply correctly the relevant mathematical algorithms. Rebmann and Viennot (1994) discuss the difficulty of many university physics students in applying and interpreting algebraic sign conventions consistently in a variety of topics. In the past, mathematics within the physics education context was mainly examined within the context of problem solving (Bagno et. al., 2007; Redish & Smith, 2008). Some researchers pointed out that there is a blending of conceptual and formal mathematical reasoning during the mathematical processing stage (Kuo et. al., 2013, Hull et. al., 2013).

With regard to teachers' mathematical competency, Baumert et al. (2010) have shown that teachers' mathematical knowledge highly reflects on the quality of their explanations of physical phenomena. Recently, a broader view has been suggested, according to which the context of physics teaching invites interplay between physics and mathematics (Eylon et. al., 2010).

We report here on a bi-national study in which we have studied expert high school physics teachers' views with regard to the "Phys-Math" interplay and the measure they take to implement it.

We have attempted to reveal from our data the teaching treks employed by the instructors when travelling between physics and mathematics, and their strategies in doing so. The treks, referred by us as teaching patterns, were then fitted to a general PCK framework. The existence of such patterns was suggested earlier (Lehavi et. al, 2013). We have further inspected our data to reveal how the teaching patterns were manifested by different teaching sequences.

In the present study we adopted the PCK framework suggested earlier (Magnusson et al., 1999). (figure 1):

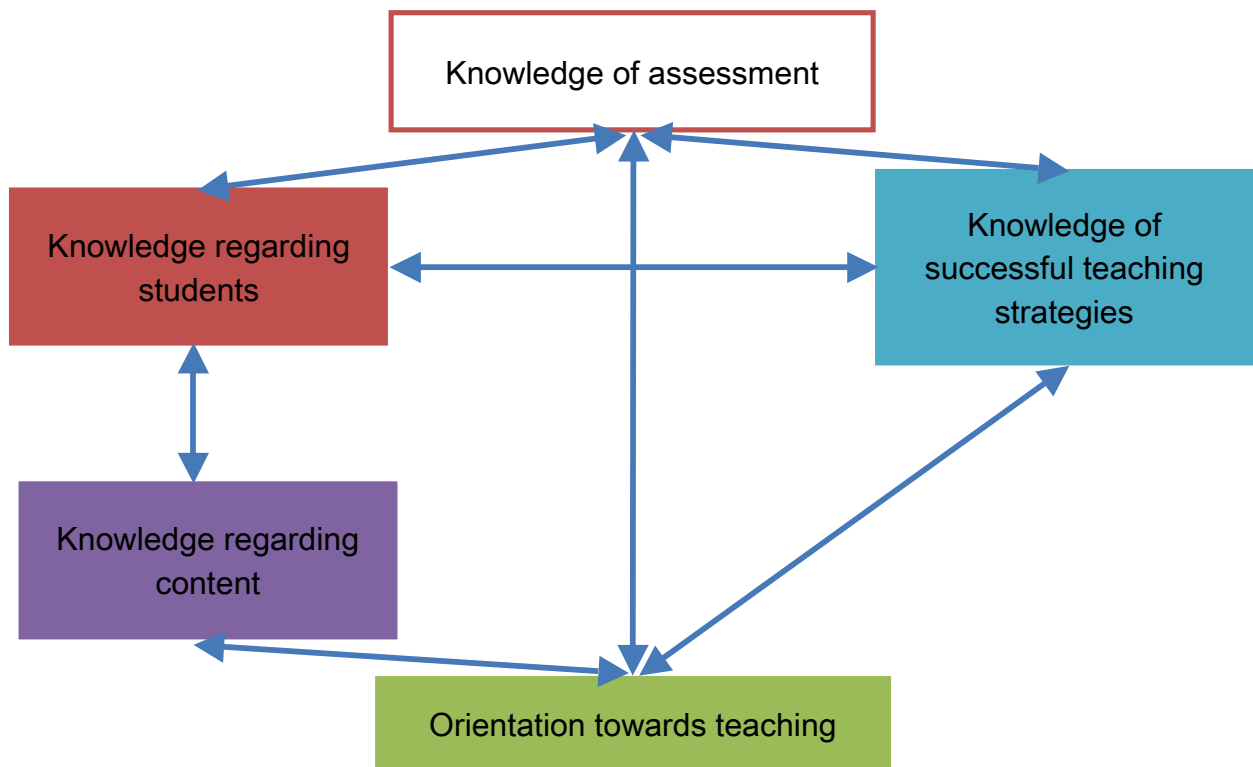

Figure 17. The adopted PCK framework

Magnusson mentioned several orientations toward science teaching: Help students develop the ‘science process skills’; Represent a particular body of knowledge; Transmit the facts of science; Facilitate the development of scientific knowledge by confronting students with contexts to explain that challenge their naïve concepts; Involve students in investigating solutions to problems; Represent science as inquiry; Constitute a community of learners whose members share responsibility for understanding the physical world, particularly with respect to using tools for science.

We limited our analysis of the interviews to the following components of the PCK framework: teachers' orientations towards teaching the Phys-Math interplay as it is related to knowledge regarding the content of this interplay and their knowledge of successful teaching strategies.

2. The research method

In pursuing the goal of finding the characteristics of the teachers' orientations towards teaching the Phys-Math interplay, we have interviewed highly experienced high school physics teachers (N = 9) from Israel (N = 8) and Germany (N = 1). Some of the teachers in our sample are considered to be master teachers.

We employed open interviews in which we asked the teachers how they construct the Phys-Math interrelation in their classroom and how they use it to enhance students' understanding of physics. Our interviewees were asked to address such questions as:

How do you construct the Phys-Math interrelation within your teaching? What mathematical insights do you use in developing insights in physics? What insights in physics are impossible to be developed without the aid of mathematics? Are there some important aspects of the interrelation between math and physics that you do not succeed in bringing them into your teaching?

The teachers provided us with examples from their own experience and also pointed out at challenges that arise in constructing this interplay.

3. Findings and first interpretation

Our findings reveal that teachers practice the use of phys-math interplay in order to foster different teaching goals. They employ physics to construct mathematical tools and descriptions and to simplify mathematical representations. Mathematics is often used to explore the behavior of a physical system, to solve a physical

problem, and to study the general context of a physical problem. In analyzing the interviews we found that the examples provided by the teachers can be grouped and arranged according to such goals.

Group A. The examples in this group are descriptions of how our interviewees demonstrate the use of mathematical exploration in examining possible behavior of a physical system. The examples cover such aspects as examination of borders of validity, borders of approximation, extreme cases and the physical ramifications of changing the value of certain parameters.

Examples

- A.1. "In Optics: the student will examine Snell's law in the format: $\sin\theta_2 = (n_1/n_2)\cdot\sin\theta_1$. No problem arises when light passes from a low refractive index medium to a medium of greater refractive index. But in the opposite direction a real problem appears. Here mathematics gently suggests to us that we may be facing a fascinating new phenomenon"

This example illustrates that the teacher find it important to demonstrate to the students how mathematical knowledge (the behavior of the sine function) can be used to study the borders of validity of a physical law. Furthermore, the teacher equips the students with a powerful physical insight: whenever the mathematical investigation of a physical law indicates a mathematical difficulty, direct your attention back at nature.

- A.2. "Consider the case of the minimum force required to move the object on a table (see figure 2).

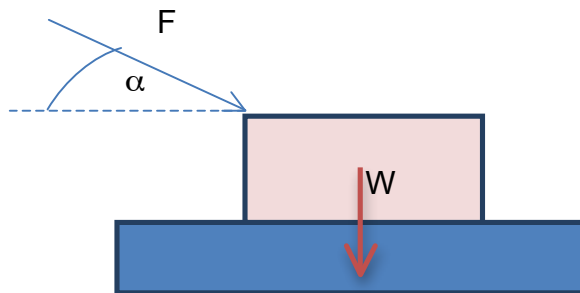

Figure 18. The minimal force required to set an object in motion

The answer is: $F_{min} = \frac{\mu \cdot W}{\cos\alpha - \mu\sin\alpha}$. I ask the students to look at the denominator (where all the demons are...) and figure out what happens when it goes to zero, or even worse, gets negative."

Here the teacher demonstrates to the students what can be gained from studying mathematical extremities of an expression that was derived for a physical problem. In the next example we can see a demonstration of how one can ask questions on the behavior of a physical system, based on exploring the parameters of a certain mathematical representation:

- A.3. "There is the equation of the "oscillating circuit". I tell the children that this [equation] has been found; what has to be changed in order for the frequency to increase? Maxwell said I need a very high frequency in order to generate electromagnetic waves. I have the theoretical prediction of Maxwell.... Then I can look with the help of the equation. What has to be changed in the circuit? The area of the capacitor has to be smaller; the number of turns has to be increased."

The teachers also stressed the importance of a good mathematical knowledge in order to be able to examine physical cases, by referring to the consequences of a lack of such knowledge.

- A.4. "... We have no point-like objects in the world. [But] we find ourselves saying: do not think about a human being, you must not think about your experiences or on a swing or a car. Anyone who begins to think about a car gets lost: what do the wheels do, the engine, whatever. No, no, no. Only point-like objects."

- A.5. "The whole algebra course, that I agree should be done, is a course which actually conceals from the eyes of the students that Newton's Second Law is a law of continuity - a differential equation. [It tells you:] go to cases with constant F then constant acceleration then all is a quadratic equation, and that's where it ends."

The teacher feels that a partial mathematical knowledge restricts the integration of math and physics and thus limits the possibility to examine borders of approximation (of point-like objects) or the true nature of physical laws with the students.

- A.6. "I would want someone else to do the work [teach the required math] for me. ... In Grade 10 Snell's Law uses up a lot of time. We used to eat gravel before we were successful in teaching them what sine is. And suddenly they learn in mathematics about sine earlier. Life became simpler."

This example provides a different perspective on the challenge encountered when students arrive to class with limited knowledge of math. The teacher finds herself required, against her own will, to teach math in order to be able to teach physics. According to her view of the phys-math interplay, the mathematical knowledge is a necessary tool for the physics teacher that should be drawn from a previously prepared "mathematical drawer".

Group B. Here we grouped examples of the means by which the teachers construct and develop mathematical representations for a physical system. They were found to do so either from experimental data or from first principles.

Examples

- B.1. "Yes, let's look at what the object actually does in the lab as problem solving.... I will teach from the behavior, or characteristics of behavior [of a system], the mathematical properties of that system. Right."
- B.2. "[With regard to refraction] I begin with experimental data and challenge them to arrive at a general relationship [between the angles]. They always try to draw a graph of one angle with respect to the other, and fit this graph with a linear function. This doesn't come out very well. So I draw for them a representation of the phenomena (see figure 3a) and ask them how can we compare the distance of the incidence ray and the refracting ray from the normal. In some cases they come up with the idea to draw a circle around the point of incident and sometimes I suggest this idea to them phenomena (figure 3b). Then they measure the distances and find out that their ratio is constant. Usually I am lucky and they draw different circles and we discuss what the mathematical meaning of this is. We then arrive from here to the sine representation of Snell's law."



Figure 19. A geometrical construction of Snell's law

- B.3. "If I want to analyze more exactly the magnetic field dependence on the number of turns [of a coil], then I have to conduct appropriate experiments, then I can develop a formula and then test this formula."

These examples demonstrate how a mathematical representation of a physical law can be constructed from empirical findings and then further elaborated within the mathematical playground and tested within the domain of physics.

Group C. Here we grouped examples that demonstrate how teachers employ mathematics to provide their students with a bird's-eye view on a specific physical problem. These examples cover the use of general laws of physics, symmetries, similarities and analogies in order to simplify the solution of a problem or to reveal how it might be related to wider aspects and contexts of physics. We included in this group also examples of a deductive derivation of physical statements.

Examples

C.1. "...A body slides with friction on another body which is placed on a frictionless surface (figure 4). I begin with Newton's laws. I have a very long board. I start at the top corner, draw the forces on each



Figure 20. Analyzing the sliding of an object from different physical perspectives lead to different mathematical analysis

body individually, write the equations for this axis and that axis, find the acceleration and from kinematics I get the speed versus time,... I then say, mmm.... can we do it in two rows? We know that there are no external forces so let's use momentum conservation... I hear voices and then I say: but two rows are too much... The CM velocity does not change, so I have V ... In one row! ...*At that instance they cannot hold back their enthusiasm and applaud... they cannot hold back their pure pleasure*"

The teacher here demonstrates how one can use physical considerations - fundamental laws and symmetry - in order to simplify the required mathematics. He further depicts that the students are not indifferent with regard to such a thread of argumentations.

C.2. "Symmetries. OK, so it is always about *symmetrical aesthetics*... For example, connecting springs and connecting resistors. I can switch between them...[or] two objects interacting through [gravitational] force, how the expression should look like so it would be symmetric as required by the third law? Addition or duplication? ... Certainly not a minus. Now, where did this requirement of symmetry comes from? *I do it explicitly, always.*

C.3. The third law, I mean, it entails mutual interaction. We therefore expect mathematics to be symmetrical. Finally, I can say [to the students] that symmetry is related to conservation."

C.4. According to Newton's second law, under a force proportional to the mass of the object on which it acts [i.e.: $F = Km$], all bodies have the same acceleration ($a = K$). We know about four such forces: (1) A force acting on a body resting in a linearly accelerated system; (2) Centrifugal force (3) Coriolis force and (4) Gravity. The first three forces are called "imaginary forces"... Maybe the same mathematical pattern suggests that there is something in common between all four forces. And maybe, God forbid, the force of gravity is also an imaginary force? And here we find ourselves in the delivery room of general relativity ..."

C.5. I use mathematics as a tool to address various phenomena that are essentially identical. I did this for harmonic motions and afterwards when we spoke about the formation of electromagnetic waves.... In other words, I take the mathematical tool as, in fact, an *organizer of knowledge* in order to see the similarity between the phenomena even if it seems that they are completely unrelated.

Physicists often look for mathematical similarities as implying similarities in nature. This example demonstrates how teaching can direct the students' attention to such mode of physical thinking. Moreover, the teacher suggests that such awareness on behalf of the students, renders introducing deep and advanced physical ideas possible. Such a teaching approach may assist students in developing a general view of physics and reduce their tendency to consider separately different topics in a textbook.

The next example demonstrates how a teacher refers to the historical evolution of physics in order to highlight the importance of a deductive derivation of physical statements:

C.6. "At some places you can arrive at [physical] insights you would not have seen in the reality, only with the aid of equations. Maxwell has thought, from his equations, that there have to be electromagnetic waves in space, and only 20 years later Hertz found these electromagnetic waves with his inductor. First was the theoretical physics, then one has tried to highlight this practically; sometimes first is the practice and then you try to mathematize it. Both aspects I try to show the children.... If I have an equation I can take many things out of it and imagine what is practically behind."

Group D. The examples in this group demonstrate how our interviewees use mathematics as a tool to solve physical problems and arrive at a better physical understanding. For some of the teachers this was the most obvious and clear demonstration of the Phys-Math interplay.

Examples

D.1. "... The [mathematical] capability will allow the students..., to acquire the tools that will enable them to deal with solving problems in physics."

D.2. "[With regard to] motion at constant acceleration, the student must be able to answer the question at what time will a body be at some point X. He will arrive [mathematically] at two solutions. He must understand that there are two physical states corresponding to the two solutions. In other words, if only one solution results, he must explain what that solution is and why there is no other solution to the equation that he wrote, for the specific problem that he addressed... he has to understand that... if mathematics is a tool, any solution that he gets by mathematics must apply to the specific case that he is investigating and that they are not two separate, unconnected drawers."

4. Phys-Math "patterns"

The interviews revealed that the teachers employ phys-math interplay as part of their practice. They use it to foster a better understanding of physics as it enables analyzing extreme cases, examining solutions and creating functional relations between physical entities. For some teachers the interplay is central in organizing and structuring the knowledge of physics: it creates webs of concepts and relationships and reveals similarities between different phenomena. Some teachers emphasized that the interplay is manifested in problem solving as it enables working with various mathematical representations.

We observed that the teachers' strategies for introducing the Phys-Math interplay follow different patterns. By patterns we do not mean here teaching sequences but rather different treks from physics to mathematics and within each of the two domains. All patterns begin with a physical description of a phenomenon, continue with mathematical manipulations and end in seeking new physical insights. However, the patterns differ by the number of steps going back and forth between the domains of physics and mathematics and within each domain and by the nature of these steps.

The patterns are listed below:

- An exploration pattern (group A): Exploring within math ramifications for the physical system: borders (of validity, of approximation), extreme cases, etc.

The trek characterizing this pattern begins with a certain physical phenomenon or system, then a mathematical representation is derived and studied purely mathematically. Then the ramifications of the mathematical analysis for the case in hand are discussed with new physical insights.

- A construction pattern (group B): Constructing and developing (from experiments or from first principles) mathematical tools to describe and analyze physical phenomena.

This trek begins either from an empirical data or from a description of a physical phenomenon using basic physical laws. Then a mathematical representation (graph, formula) is constructed. The mathematical construct is then applied to the initial physical case to provide new physical insights.

- A broadening pattern (group C): Adopting a bird's-eye view and employing general laws of physics, symmetries, similarities, analogies.

Here again the trail begins from a phenomenon or a physical case, employs an already known mathematical representation, broadens them and then broadens the physical scope and seeks for new insights.

- An application pattern (group D): Employing already known laws and mathematical representations in problem solving.

The steps characterizing this pattern go from the physical case to its already known mathematical representation, conduct mathematical manipulations and arrive at a mathematical solution which is then tested against the case in hand.

To summarize: Groups A-D might be represented by the following categories of the various aspects that are manifested in the phys-math interplay as practiced within physics teaching (table 1):

Table 17: Categories of the practices A-D

Category	The phys-math aspect	The teaching practices
A. Exploration	Mathematics is used to explore the behavior of physical systems.	Examination of: <ul style="list-style-type: none"> • Borders of validity • Borders of approximation • Extreme cases
B. Construction	Mathematical model can be constructed for physical systems.	Constructing mathematical model from: <ul style="list-style-type: none"> • Empirical data • First principles
C. Broadening	Mathematics can broaden the scope of a physical context.	Employing mathematics to seek for: <ul style="list-style-type: none"> • Similarities • Symmetries • Analogies
D. Application	Mathematics provides aid in problem solving.	Manipulating with mathematical representations in order to arrive at a solution for a given problem

The considerations within each of the two disciplines are presented in table 2.

Table 18

Physical considerations	Mathematical considerations
<ul style="list-style-type: none"> • Description of a physical case • Examining applicability for the physical system • Scrutinizing laws of physics • Broadening the physical applicability • Seeking for new physical insights 	<ul style="list-style-type: none"> • Applying an existing mathematical representation • Exploring the representation mathematically • Constructing simple mathematical representation • Sophisticating the mathematical tools • Manipulating with the mathematical representations

One may visualize how different steps which comprise a certain pattern are conducted between the two disciplines and within each of them:

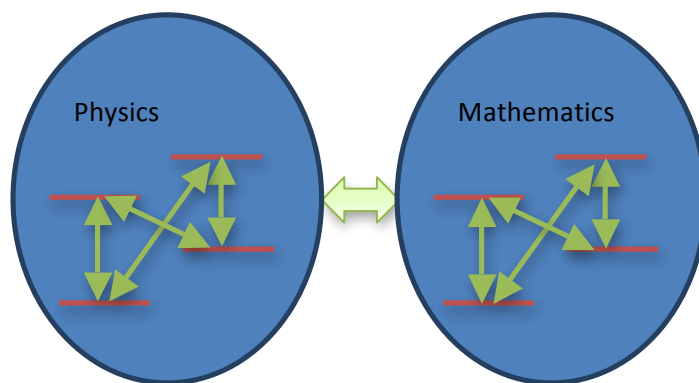

Figure 21. Optional treks within each domain and between them. A specific trek represents a teaching pattern which addresses certain goals of the Phys-Math interplay.

5. Phys-math "patterns" and the teachers' PCK

Teaching orientations is highly important in teachers' PCK as they serve as 'conceptual maps' that guide a teacher's instructional decisions concerning curricula, classroom activities, classroom materials, student assignments and the evaluation of students' learning (Magnusson et al., 1999). The examples provided by the teachers clearly address most of these aspects of teaching physics. They mentioned the role of Phys-Math knowledge in deductive reasoning, in the relation of experiment and theory, in constructing students' broad view of physics and in problem solving.

In our research the teachers' orientations towards teaching the phys-math interplay was manifested in the patterns they have chosen as each pattern is employed to serve specific teaching goals. The teachers demonstrated to their students how each of the patterns: phys-math exploration, construction, broadening and application facilitate different aspects of physics understanding. Thus, these patterns may represent different answers to the question: what approach would foster the understanding of a certain aspect of the Phys-Math interplay (see table 1) which is important for me (the teacher) to teach? Each choice served the teachers as a guide by which they designed their teaching.

Our study supports the claim that orientations play a critical role in distinguishing the quality of teaching (Abell, 2007). Most of the examples in groups A-C were provided to us by teachers who are considered to be master teachers. These teachers were very clear on rendering students *aware* of various aspects of the phys-math interplay. They also addressed in the interviews the deep relations between physics and mathematics in philosophical and historical perspectives.

6. Summary

The teachers in our study demonstrated knowledge about the interplay between physics and mathematics in different perspectives. They demonstrated different levels of awareness regarding the various patterns of the interplay and the teaching methods for each pattern. The level of awareness differentiated the master teachers from the other expert teachers.

In order to address the question what are the teachers' orientations towards teaching the phys-math interplay we first categorized their teaching practices in that respect.

Our interviewees also described various teaching strategies that they employ within the phys-math interplay. Those strategies might be related to another aspect of the PCK framework: Knowledge of successful teaching strategies (figure 1). As we proceed with the analysis of our data, we shall address the question what do teachers regard as good teaching approaches to foster students' mastering the aspects of the Phys-Math interplay? We also plan to reach a wider range of teachers than our group of selective top teachers. We have also started working with a small group of teachers on developing examples of math-physics interplay patterns and strategies to use and try in classroom. We will then study their effects on both teachers' instruction and students learning.

References

Abell, S. K. (2007). Research on science teacher knowledge (Chapter 36). In S.K. Abell and N.G. Lederman (Eds.), *Research on Science Teacher Education*, pp.1105-1149, New York: Routledge.

- Bagno, E., Eylon, B., and Berger, H. (2007). Meeting the challenge of students' understanding formulas in high-school physics - a learning tool. *Physics Education* 43(1), 75-82.
- Eylon, B., Cohen, E., and Bagno, E. (2010). The interplay of physics and mathematics in a graduate quantum mechanics course for physics teachers, talk given in GIREP-conference 2010 in the Symposium: Addressing the role of mathematics in physics education.
- Hull, M., Kuo, E., Gupta, A., and Elby, A. (2013). Problem-solving rubrics revisited: Attending to the blending of informal conceptual and formal mathematical reasoning, *Physical Review Special Topics - Physics Education Research*, 9, 1.
- Lehavi, Y., Bagno, E., Eylon, B-S., and Cohen, E. (2013). Can math for physics teachers impact their conceptual knowledge of physics? An oral presentation given in the 2013 Girep conference, Prague.
- S. Magnusson, J. Krajcik, & H. Borko, Nature, sources and development of pedagogical content knowledge for science teaching. In J. Gess-Newsome & N. G. Lederman (Eds.), *Examining pedagogical content knowledge: The construct and its implications for science education* (pp. 95-133). (Kluwer Academic Publishers, Dordrecht, 1999).
- Pospiech, G. and Matthias, S. (2011). Quantum physics in teacher education, proceedings of the 12th international symposium Frontiers of Fundamental Physics [FFP12], Udine.
<http://www.fisica.uniud.it/~ffp12/proceedings.html>
- Kuo, E., Hull, M. M., Gupta, A., and Elby, A. (2013). How students blend conceptual and formal mathematical reasoning in solving physics problems, *Sci. Educ.* 97, 32.
- Redish, E. F., & Smith, K. A. (2008). Looking beyond content: Skill development for engineers. *Journal of Engineering Education*, 97(3), 295 – 307.

Research Based Activities in Teacher Professional Development on Optics

Marisa Michelini, Alberto Stefanel

Research Unit in Physics Education, DCFA, University of Udine, Italy

Abstract

The aim of this research is to understand how teachers take ownership of content given them in formative intervention modules and transform it into suggestions and materials for teaching. To this end a module on optics was designed for a group of kindergarten, primary and lower secondary school teachers which sought to integrate meta-cultural, experiential and situated approaches with various context specific factors. The study investigated how teachers deal with conceptual difficulties in the module and how they adapt it to their school situations with data being gathered through a variety of tools. It emerged that the most difficult concepts teachers encountered at the formative stage were those they most often incorporated into their materials. The steps taken in this process of appropriation were then reviewed via a collaborative discussion among the teachers themselves on the materials they had produced.

Keywords

Primary teachers professional development; Optics, ownership, appropriation

1. Introduction

The knowledge society and its rapid change have led to the need for new professionals and it is the teacher who perhaps has to change the most (Duffee, Aikenhead 1992; van Driel, Beijaard, Verloop 2001; Guskey 2002; Berger, Eylon, Bagno 2008). A wide research literature indicates that education based on resources and the transmission of content (the banking model) is not sufficient even when it promotes active student learning (Borko 2004; Gess-Newsome 1999; Oakes et al. 2000; Michelini 2004; Viennot et al. 2005). Education thus needs to take into account differences between trainee teachers (Lieberman, Wood 2001; Siskin 1994), and what they individually learn (Klein 2007; Lampert, Ball 1999) so that communities of professionals who ground learning in practice both as regards content (Ball, Cohen 1999; McLaughlin, Talbert 2006) and context (van Driel et al. 2001; Guskey 2002; Klein 2007) can be created. It is argued that with the help of professional teacher development teachers can become personally involved in specific contexts to transform those competencies that are most resistant to change (Klein 2007; Wayne et al. 2008; Borko 2004), especially as in any didactic innovation there tends to be a relapse phase that results in the reproduction of school practice, styles and traditional methods (TIMSS 2007; Angell 2012).

The focus in previous research has been on how professional development helps teachers to adapt their teaching practice so that their children can take an active role in the construction of knowledge and on how teachers transform the subject matter they are given in formative modules into suggestions and materials for teaching. In primary school the preparation of teachers in science raises a serious issue concerning subject content and the way such content can be taught to children in the form of games and ludic exploration based on conceptual challenge (Davis, Smithey 2009; Metz 2009; Mikeska et al. 2009; Michelini, Stefanel 2014). Thus, in the present research project a Formative Intervention Module (FIM, henceforth) on optics was designed for three groups of kindergarten, primary and lower secondary school teachers. Here we discuss the characteristics of the FIM, the way teachers face the conceptual problems on optics in the module and how they appropriated the concepts for use in the classroom.

2. The formative intervention module - FIM

To help teachers improve their professional competence in the basic concepts of geometrical optics, design education activities to practice such concepts, assist their students in dealing with the conceptual challenges and learning difficulties involved and finally become aware of their own learning path a specific FIM was implemented. This was conceived as a formative path characterized by close interaction between researchers and teachers and following a modular format in which each teacher was supported in designing their own

activities and implementing them autonomously in the classroom. It was the result of a collaborative process involving special agreements between the University of Udine and institutions including different kindergarten, primary and middle schools in three little towns in the area around Udine, and developed within the framework of a national school / university project ¹.

Collaboration took place between university researchers, school teachers and the principals of the institutions. The FIM was designed by university researchers, discussed with teachers in all three schools and divided into three specific activities conducted in parallel in the three schools in five sessions of three hours each by (usually) a pair of researchers working together. It sought to integrate meta-cultural, experiential and situated - context specific teacher education approaches (Michelini et al. 2013) and started with an introduction to the history of optical concepts so as to gauge how teachers engaged with the interpretative problems on the mechanism of vision, basic optical phenomena and the nature of light. These issues were then re-explored operatively by teachers through simple experiments and a test (CK-PCK test below), based on problem solving, designed to encourage reflection on both the specific conceptual difficulties that occurred, and how they could be addressed in the classroom.

The design and implementation of microteaching activities were interspersed with formative sessions, to ensure both the active role of teachers in the construction of their conceptual basis and to enable them to reutilize this experience as a method of inquiry with their own students. The steps suggested for teacher – student interaction were as follows: Pupils –

- A) search autonomously for information (in the form of photos, pictures ..) from books, cartoons, newspapers that illustrate light phenomena
- B) decide how to classify their various information using their own criteria
- C) discuss with teacher a new classification according to criteria based on physics phenomena classification
- D) do experiments with simple apparatus in the classroom on the phenomena that have emerged
- E) explain the information they collected in A on the basis of the physics criteria discussed in C
- F) visit an online gallery and identify light phenomena in selected pictures
- G) individually produce their own picture of one or two phenomena, explaining it with a short text and uploading their work onto the web for “I-like” and quality jury evaluation.

Table 1. Outline of the FIM on optics for primary school.

Session – Content
I - Historical conceptions of light as evidenced in research on: optical phenomena; mechanism of vision <ul style="list-style-type: none"> • Reconstruction of the meanings of the concepts involved (through experiments): • Re-construction of what is involved in the mechanism of vision (properties of light, interaction light-object, role of light (reflection, diffusion, entrapment) • Rectilinear propagation of light and experimental evidence for it • Experiments to explore reflection, refraction • Shadow formation by sun-light (sun motion and the reference system) • Smoke chamber and the phenomena of light-matter interaction
II - Operative path on sun astronomy: direction of the sun’s rays; illumination and the seasons
III - Experiment on refraction laws and image formation via a lens. Operative path on light and colors (interaction between light-object, light-eye)
IV - Conceptual problems in optics as background for educational design
V - Interplay between the educational direction taken in teacher formation

¹ The activity “Adopting Science and Art in Primary Schools” is a section of the project IDIFO promoted by the Research Unit in Physics Education of the University of Udine in collaboration with 20 Italian Universities, in the National Plan for Science Degrees of the Italian Ministry of Education, Research and Universities.

and the process teachers implement in the classroom with their pupils.

3. Goal of the present study and the research questions

The present study in the area of professional teacher development seeks to explore the process by which teachers take a particular educational direction, by focusing on the following research questions:

RQ1: how do teachers engage with the conceptual knots on light and the mechanism of vision explored in the MIF?

RQ2: how and how far do they adopt and use in classroom the historical premises, experiments and problem solving activities suggested in such sessions?

RQ3: how do they transform the educational path offered them in MIF?

4. Monitoring Instruments

The data on the process activated in the FIM were collected using a variety of different instruments and sources:

- A) A researcher took written notes on the dynamics that developed in the training sessions, noting in particular how the teachers reacted to the suggestions made by the researcher in charge of the session, and what questions they posed during each session, and what their learning problems and suggestions were;
- B) The teachers also made written notes, creating a personal record of what they felt they had learnt during the FIM and what was still unclear to them so that a general picture of what concepts were clear, what problems had been faced but overcome and what was still problematic could emerge from the sessions.
- C) A test (the CK-PCK), described in figure 1 below, was used to monitor learning problems. The teachers answered the questions at home both at the beginning of the FIM and after content sessions
- D) A series of microteaching tasks were developed by the teachers at the end of the module. These were tested out in class and analyzed to see how far they had modified the proposals made by the FIM. Finally, the further materials produced by their pupils was also analyzed to gauge how much such pupils had learnt from the process.
- E) Learning outcomes of the teaching / learning process, as documented by the teachers, were used to gain indirect information on the educational direction taken, how the teachers worked in the classroom and how the pupils learnt.

Results and findings emerge by the triangulation and cross check of data.

BLE

The CK-PCK test on optics

Two questions (Q1, Q11) are designed as PCK items, with a part concerning the conceptual aspect (the CK part) and a related part where teachers are request to analyze typical students' answers individuating the reasoning at the origin of each answer

Q1.

- What represent the lines ST₁ and ST₂?
- Considering the points a, b, c, d and the point t on the surface of the screen, from which of them is visible the light source ?
- In what areas there is light?
- In what areas there is shadow?

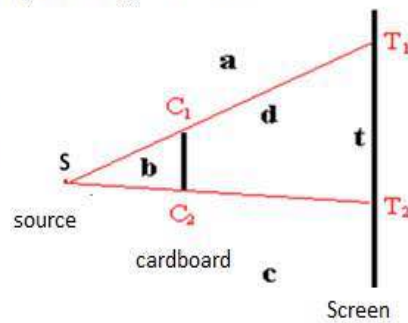

1.1 What answers to each question?

1.2 The questions was posed by a teacher and three children trigger a discussion:

- Michele: lines are the rays of light coming out from the flashlight and you will see the screen lit up around the shadow
- Teresa: if they were all the rays coming out from the torch, the cardboard would not be illuminated
- Aldo: in t you cannot see the light of the torch, but perhaps in d a bit

Discuss the position of each student, indicating the conceptual learning knot underlying it.

Q3.

- represent a light source
- is a black screen
- is a mirror placed on the wall P

Can a person who is in the room to see the reflected image of the source?
If yes where should position?
Draw the locations and explains the drawing.

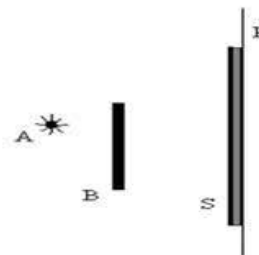

Figure 1. The PCK question Q1 and the CK question Q3 of the test

A CK-PCK test was designed to address the main learning problems considered in the FIM. The test comprises 20 items (Q1-Q20), each of them concerning a specific conceptual knot: the mechanism of vision (Guense 1984, Galili 1996); the rectilinear behavior and the formation of shadow from a source point, from two source points, from a diffused source (Wosilait et al. 1998); reflected light travel (Bouwens 1987, Colin et al. 2002); how an image is formed with a flat mirror; the illumination of perfectly reflecting walls in a room with a little bulb (Rone, Eylon 1993; Viennot 1996); the light pattern passing from one medium of propagation to another; how images are formed by refraction (Fredlund, Airey, Linder 2012); and image formation by means of a tin lens (Goldberg, McDermott 1987). Two questions are designed as PCK items, with one part concerning the contents and conceptual aspect (the CK part) and another part where teachers are requested to individuate reasoning behind typical student answers and suggest interventions modality. Here we consider the PCK question Q1, concerning the rectilinear propagation of light, and the CK Q3 question on reflection (Fig.1).

5. Methodology of analysis

The analysis of the open responses in the CK-PCK test followed the criteria of qualitative research (Erikson 1998; Niedderer 1989) and sought to individuate qualitatively different typologies, or categories, of answers (Niedderer 1989; Stephanou 1999). To this end it set out to construct mutually exclusive profiles, by means of a phenomenographic methodology (Marton 1981). The categories of answers concerning CK questions were based on interpretative criteria (which elements of the scientific model were included, and how comprehensive or naïve the understanding shown was), descriptive criteria (which elements were focused on), trainee conceptions and learning problems. The categories of answers relating to PCK questions considered the ways the teachers suggested facing any learning problems in the classroom.

The data emerging from the CK-PCK test distributed at the beginning of the FIM were compared with the notes taken by the researcher / observer and with those written in free form by the teachers to highlight the issues they had understood and the areas that remained problematic.

The educational materials and procedures prepared by teachers were first subjected to a content analysis to identify the ideas they included and how they intended to implement them in the classroom. They were then given a project design analysis using instruments and criteria established in previous research (Borghini et al 2004, Michelini et al. 2004, Michelini, Bisesi 2008). The educational paths outlined by teachers were evaluated on the basis of the elements listed below, assigning a point, from 0 (element absent) to 3 (excellent element):

A) Rationale of the path taken; B) Coherence/logic of the educational path taken; C) inclusion of experiments; D) Student centred approach; E) Discussion of the motivation for their choices.

6. Analysis of CK-PCK test (implemented during the FIM)

As far as trainee learning problems are concerned we can consider here the answers to question Q1 (From which point the light source can be seen; at which point there is light and in which shadow; and what comments were made on the children's responses) and Q3 (fig.1), on rectilinear propagation and reflection.

Table 2. Categories of answers of Q1 item.

Question	Category A	Category B	Category C
What do the lines ST1 and ST2 represent?	Rays passing beyond the card (3/18)	Light beam/rays (9/18)	Limits of the light cone from the torch (6/18)
B) Considering points a, b, c, d and point t on the surface of the screen, from which of them is the light source visible?	abc (13/18)	ac or bc (3/18),	b (2/18)
C) In what areas is there light?	abc (8/18 – all 13) abc and partially in the region T1C1C2T2 “because light diffused” (2/18).	in b and along ST1 e ST2 (4/18)	«on the screen» (2/18)
D) In what areas is there shadow?	in d and t (8/18)	in t (6/18) in d (2/18)	in acdt (2/18)

With regard to the first two points of question Q1 there were quite different responses, although teachers would probably have expected the same answer (Tab.2). The source is seen from: the areas ABC (13/18); only two zones (either AC or BC) (3/18), only the area B (2/18). It has light: in the areas ABC (8/18 - all of the 13 above), along ST1 and ST2 (4 / 18), on the screen (2/18) on ABC and partly in the region T1C1C2T2 "because the light spreads" (2/18). There is shadow in d and t (8/18), t (6 / 18); in d (2/18); in ACDt (2/18). As for the way the teachers analyzed student sentences (Michele: «lines ST1 and St2 are the rays emerging from the light source»), it emerged that they essentially individuate those aspects they consider problematic for students: light propagates in a rectilinear way (11/18) and “S-t1 S-T2 are border rays” (3/11); Michele perceives light only at its limits (2/18); he describes the situation (2/18); “He tells the truth, identifying the illuminated area” (2/18); the cardboard prevents the rays from passing (1/18).

The difficulties encountered in the analysis of rectilinear propagation of light situations were then overcome at the end of the FIM by the teachers, who succeeded in transforming these situations and problematic questions into teaching activities.

As regards the reflection situation proposed in question Q3 (fig. 1), the typical representation of the teachers is shown in fig 2, concerning the points from where it is possible to see the image of source A reflected by mirror S. The frequencies of occurrence are: A) 2/18; B) 8/18; C) 5/18; D) 2/18. A fifth category includes the assertion “behind the screen” (1/18). Although these teachers knew the law of reflection, they adopted alternative models to indicate areas from where the image of the source is visible. As can be seen, only in case B is there a local application of the law of reflection.

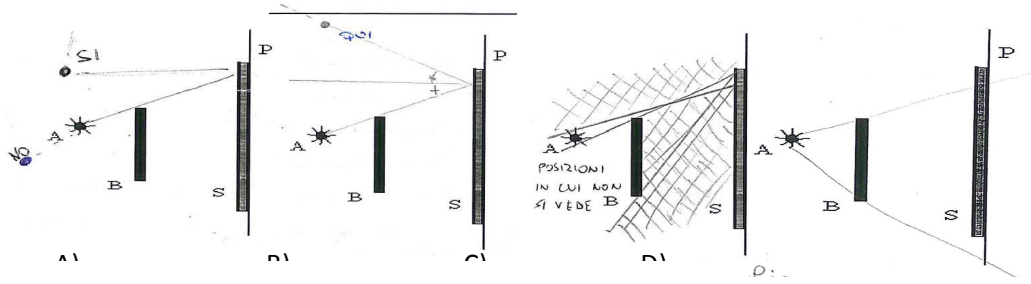

Figure 2. Typical representation of the teachers concerning the points from where it is possible to see the image reflected by the mirror of the source.

Considering the teacher home work “Analysis of the single items of the test”, there were two main problem areas: how the image is formed by reflection emerged at an explicit level (“I am not clear how an image is formed by reflection”); and refraction emerged a problematic area at different levels (image formation, refraction law) and remained problematic. The items that they suggested teaching pupils were reflection presented in a symbolic form and refraction presented with photos of real situations.

In the teacher written work “what I learned during the FIM”, it is possible to make the list of the subject matter of the MIF that constitute the explicit learning of teachers: A) Mechanism of vision; B) Rectilinear propagation; C) Color formation; D) Parallelism of sun rays; E) Ray deviation in refraction, while the consideration most widely shared was the conviction that they had changed their “way of teaching” and extended their “own safety zone” in dealing in the classroom with themes in the field of optics.

This change effectively emerged also from the analysis of the educational project designed by the teachers. The themes of the educational paths designed by N=15 teachers are summarized in table 4, for each of the three teacher groups: kindergarten, primary, middle school.

Table 4. The content included in the educational paths. Ki: teacher of kindergarten; Pi: teacher of primary school; Mi: middle school teacher. The numbers indicate the sequence designed.

Teacher	of interaction light-matter	rectilinear propagation	To see the light	Light sources	Vision mechanism	Reflection as phenomenon (inc angle=refl angle)	formation and symmetry of the reflected image	Diffused reflection	Refraction as phenomenon	Imagine viaa lens	Absorption phenomenon	Shadow formation source	Colors	Dispersion		
K1	1	3			2	4	5									
K2	1	3			2	4			5							
K3	1	3			2	4			5							
K4	2	4			1	5	6		9			3	7	8		
P1	5	4	1	2	1	7	8	9	10			6	3			
P2		1				3			4			2				
P3		1				3			4			2				
P4	1	2				3	4		5	6						
P5	1	6	5	2	3	7	8		9			4				
P6		2		1		4	5		6			3				
P7		4	3	2	1	6	7	8	9	10		5				
P8	5	4	3	2	1	9	10		7	11	6	8				
M1		1	2			3			4					5		
M2		2			1	3	4		5	6				7		
M3		1				2			3					4		
Tot	8	15	5	5	9	15	5	6	3	13	3	1	8	1	4	1

In the following we discuss how teachers appropriated content and transformed it into teaching plans. Among the issues that took up most time in the FIM both in terms of the situations discussed and the experiments carried out, all or almost all of the teachers identified the rectilinear propagation of light and the recognition of reflection and refraction phenomena as core nuclei to be presented to the students. The approach adopted by the teachers for their students was most often limited to the recognition of the phenomenon and only 1/3 of them included the law underlying the phenomenon of reflection, how it is possible to “see” light (for instance using a smoke chamber), and how shadows are formed. 2/3 of the teachers explicitly included the physical mechanism of vision in their educational project in line with the emphasis given to it during the FIM as a prerequisite for an approach to the phenomena of light. For the remaining 1/3 of the teachers this aspect remained at an implicit level or was completely neglected. Individual aspects, such as image formation in a lenses, or absorption, were included as issues to be dealt with by only a few teachers, while the colour of objects was a topic touched upon by all the middle school teachers. The study of the sources, usually classified into primary and secondary sources, as is often done in textbooks, was included by 1/3 of teachers, although it was barely mentioned in the FIM. The conceptual difficulties that emerged as problematic during the formative sessions, such as those related to the formation of images by plane mirrors and the reconstruction of the path taken in the propagation of light in the case of refraction, were also those most taken into consideration in the teachers’ plans.

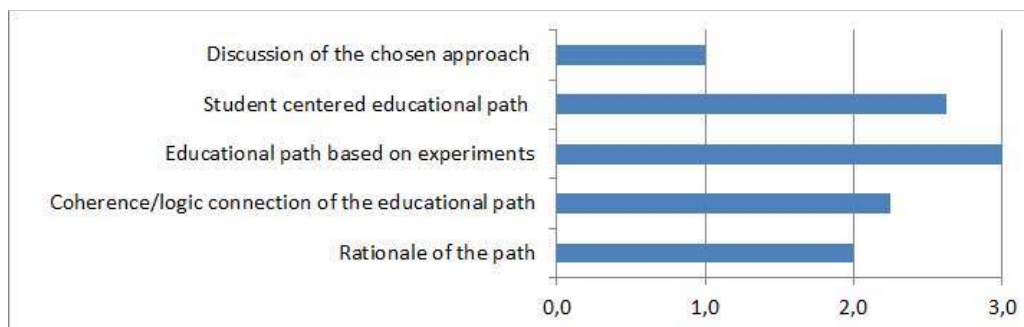

Figure 4. Typical representation of the teachers concerning the points from where it is possible to see the image reflected by the mirror of the source.

The analysis of the educational paths proposed by the teachers on the basis of the design criteria is shown in figure 4. This indicates that a general use of experiments, a student centered focus and ease of transferability in putting the paths into practice were important features. This was confirmed by the analysis of the pictures created by the pupils at the end of their learning path, where a major role was played by the experimental situation explored, the symmetry of the reflected image, the features of the refracted images and the use of simple apparatus that could easily be reproduced.

7. Conclusion

The study presented here focused on the professional development of teachers. It looked at the process of appropriation by teacher teachers of an educational path in optics. A Formative Intervention Module on optics was designed in a research collaboration between the University of Udine and some schools in the neighbourhood of the town of Udine. It was characterized by close interaction between researchers and teachers, had a modular nature, and integrated, in the activities and personal work of the teachers, meta-cultural, experiential and situated approaches. To collect data different instruments and sources were used, to extract information on the formative process from different points of view.

As regards the way teachers engaged with conceptual difficulties concerning light in their formative module (RQ1), it emerged from the data that they experienced the following areas as problematic: image formation by reflection (symmetry); shadow formation and rectilinear propagation of light. Only 1/3 of them chose the mechanism of vision, important for their overall understanding, as a learning goal. More than the laws of reflection, the teachers tended to focus on reflection/refraction as phenomena (where it is possible to recognize them) and on features of the reflected/refracted images. The conceptual problems that remained were also problematic in the teaching, as for instance how to explain an image in terms of the law of reflection, how to explain images in terms of the law of refraction, and how to choose examples to represent them (RQ1).

As regards the way and the extent to which teachers selected and used the historical premises, the experiments, the proposed problem solving (RQ2) in their classrooms, it emerged that crucial for their appropriation of the educational path explored in the formative module were experiments performed by themselves/constructed by themselves; the coherence of the conceptual path followed in the formative module; the problem solving activities and reflection; and the analysis of the questions of the CK-PCK test. Moreover, maximum attention was given, in the educational paths designed and implemented in the classroom by teachers, to creating an active role for the students and more in general to ensuring student learning. The concepts included were those that were clearer to the teachers such that problematic concepts in their personal formation remained unresolved in the teaching sequences. The historical premises in optics were retained by teachers as part of their personal culture, but did not appear to influence the content of the educational path designed and implemented in their classrooms. (RQ2)

As for the way teachers transformed the educational path outlined in their training (RQ3), a variety of content was selected: they tended to focus on the themes connected with the reflected image and its symmetrical properties while generally speaking they did not include diffused reflection or, as stated above, the mechanism of vision. They transferred their learning path into teaching sequences paying attention to pupils own learning activities activated by experimental exploration.(RQ3)

In conclusion what emerges from the study was the important role in the formative module, first, of a research based educational path as a point of reference for the design activities of the teachers and, secondly, the hands on activities they experienced that helped them to understand how to teach very young pupils important concepts, how to reflect on conceptual difficulties to clarify the concepts and how to face such problems with their students in the classroom.

References

- Angell, C. (2012). TIMSS Advanced, In GIREP-EPEC Conference 2011, August 1 – 5, Jyväskylä, Finland.
- Ball, D. L., & Cohen, D. K. (1999). Developing practice, developing practitioners. In L. Darling-Hammond, G. Sykes (Eds.), *Handbook of policy and practice* (pp. 3-31). S.Francisco: Jossey-Bass.
- Berger, H., Eylon, B-S. and Bagno, E. (2008). Professional Development of Physics Teachers, *Journal of Science Education Technology*, **17**, 399–409.
- Bisesi, E. and Michelini, M. (2010). *Comparative teaching strategies in special relativity*, in *Physics Curriculum Design*, Constantinou CP, Papadouris N eds, The Learning in Science Group, Cyprus.
- Borghi, L., De Ambrosis, A., Mascheretti, P. (2004). From University courses to teaching practice in schools: an example, in *Quality Development in teacher Education and training*, Udine, Forum, pp. 420-424.
- Borko, H. (2004). Professional development and teacher learning. *Educational Researcher*, **33** (8), 3–15.
- Bouwens, R.E.A. (1987). Misconceptions among pupils regarding geometrical optics. In *Proc.of the third Seminar on Misconceptions and Educ. Strategies in science* (pp. 23-38). Ithaca Cornell University, Vol III.
- Colin, P., Chauvet, F., & Viennot, L. (2002). Reading images in optics: Students' difficulties and teachers' views. *International Journal of Science Education*, **24** (3), 313–332.
- Davis, A. and Smithey, J. (2009). Beginning Teachers Moving Toward Effective Elementary Science Teaching, *Science Education*, **93**(4), 745–770.
- Duffee, L. and Aikenhead, G. (1992). Curriculum change, student evaluation, teacher practical knowledge, *Science Education*, **76**, 493-506.
- Erickson, F. (1998) Qualitative research methods for Sci. Educ. In Int.H. of Sci. Educ.. Part 2. Ed Fraser B. J., Tobin K. G. (p. 1155-1174). Dordrecht, Kluwer Ac. Publ.
- Fredlund, T., Airey, J., Linder, C. (2012). Exploring the role of physics representations: an illustrative example from students sharing knowledge about refraction, *European Journal of Physics*, **33** (3), 657-666.
- Galili, I. (1996). Students' conceptual change in geometrical optics, *International Journal of Science Education*, **18** (7), 847-868.
- Gess-Newsome, J. (1999). PCK: an introduction and orientation. In J. Gess-Newsome, N. G. Lederman (Eds.), *Examining PCK* (S. 3–17). Dordrecht: Kluwer.
- Goldberg, F.M. and McDermott, L. (1987). An investigation of students' understanding of the real image formed by a converging lens or concave mirror, *American Journal of Physics*, **55**, 2, 108-119.

- Guense, E. (1984). Children's ideas about light / les conceptions des enfants sur la lumière, *New Trends in Physics Teaching*, Vol IV UNESCO, Paris, 179-192.
- Guskey, T.R. (2002). Professional Development & Teacher Change. *Teachers & Teaching*, **8** (3), 381-391.
- Klein, E. J. (2007). Rethinking Professional Development, *The New Educator*, **3**, 179-197.
- Lampert, M. and Ball, L. (1999). Aligning teacher education with contemporary K-12 reform visions. In Lieberman, A. and Wood, D. (2001). When teachers write: Of networks and learning. In A. Lieberman, L. Marton F. (1981) Phenomenography. *Instructional Science*, **10**, p. 177-200.
- McLaughlin, M. W. and Talbert, J. (2006). *Building school-based teacher learning communities: Professional strategies to improve student achievement*, Teachers College Press, New York, USA.
- Metz, K. E. (2009). Elementary School Teachers as “Targets and Agents of Change”., *Reform Science Curriculum*, **93** (5), 915-954.
- Michelini, M ed. (2004). *Quality Development in the Teacher Education and Training*, selected papers in Girep book, Forum, Udine, Italy. Michelini M. Ragazzon, R., Santi, L., Stefanel, A. (2004). *Implementing a formative module on quantum physics*, in *Quality Development in Teacher Education*, Michelini M ed., Forum, Udine, pp.429-435.
- Michelini, M., Santi, L. and Stefanel, A. (2013). La formación docente: un reto para la investigación, *Revista Eureka sobre Enseñanza y Divulgación de las Ciencias*, **10** (Núm. Extraordinario), 846-870.
- Michelini, M., Santi, L. and Stefanel, A. (2014). PCK approach for prospective primary teachers on energy. In Tasar F. (ed.), *Proceedings of The WCPE 2012* (pp. 473-478), Istanbul: Pegem Akademiel.
- Michelini, M. and Stefanel, A. (2014). Prospective primary teachers and physics PCK's. In Kaminski W. and Michelini M. (eds.), *Teaching and Learning Physics today*, (pp.148-157). Udine: Girep, LithoStampa.
- Mikeska, J.N, Anderson, C. W. and Schwarz, C. V. (2009). Principled Reasoning About Problems of Practice, *Science Education*, **93** (4), 678-686.
- Liederman, A. and Miller L. (Eds.) (2001). *Teachers caught in the action* (pp. 174-187). New York: Teachers College Press.
- Niedderer, H. (1989). Qualitative and quantitative methods of investigating alternative frameworks of students. Paper presented to the AAPT-AAAS meeting.
- Oakes, J., Hunter Quartz, K., Ryan, S., & Lipton, M. (2000). *Becoming good American schools*. S. Francisco, USA: Jossey-Bass.
- Rone, M. and Eylon, B.-S. (1993). To see or not to see: geometrical optic, *Physics Education*, **28**, 52-59.
- Siskin, L.S. (1994). *Academic departments in secondary schools*, Falmer, Washington DC, USA.
- Stephanou, A. (1999). The Measurement of Conc. Understanding in Phys., Early conf. TIMSS (2007). Trends in International Mathematics and Science Study, <http://www.timss.bc.edu/>
- van Driel, J. H., Beijaard, D. and Verloop, N. (2001). Professional Development and Reform in Science Education, *Journal of Research in Science Teaching*, **38** (2), 137-158.
- Viennot, L. (1996). *Raisonnement en physique*, Ed. De Boeck Université, Paris, Bruxelles.
- Viennot, L., Chauvet, F.O., Colin, P. and Rebmann, G. (2005). Designing Strategies and Tools for Teacher Training: The Role of Critical Details, Examples in Optics, *Science Education*, **89** (1), 13-27.
- Wayne, A.J., Yoon, K.S., Zhu, P., Cronen, S. and Garet, M. S. (2008). Experimenting with Teacher Professional Development. *Educational Researcher*, **37** (8), 469-479.
- Wosilait, K., Heron, P.R.L., Shaffer, P.S. and McDermott, L.C. (1998). Development and assessment of a research-based tutorial on light and shadow, *American Journal of Physics*, **66**, 906-913.

Affiliation and address information

Marisa Michelini, Alberto Stefanel
Research Unit in Physics Education
Department of Chemistry, Physics and Environment
University of Udine
Via delle Scienze, 206

33100 Udine, UD, Italy

e-mail: marisa.michelini@uniud.it, alberto.stefanel@uniud.it

Exploring Sliding Friction: an Inquiry-Based Experience for Pre-Service Science Teachers.

Vera Montalbano.

Department of Physical Sciences, Earth and Environment, University of Siena, Italy.

Abstract

In order to engage pre-service science teachers in an active learning process, a qualitative introduction to friction was presented. The exploration of different kind of materials suggested which aspects could be relevant and which interaction was involved in explaining their different behaviours. Many participants encountered some cognitive conflicts in the activity and rarely were able to overcome them by themselves. Learning difficulties in modelling are presented and compared with the ones encountered by students from a scientific high school (age 16 – 17 y) that performed the same exploration on friction.

Keywords

Friction, active learning in laboratory, secondary school, pre-service teacher education, modelling

1. Introduction

Physics plays a fundamental role in science education as an accessible context for experimental design, scientific argumentation, problem solving and the development of multi-step reasoning skills. Especially in the physics lab, students can actively develop scientific processes and habits of mind typical of physics and science in general. Nevertheless, pre-service science teachers have few opportunities, in higher education, of experiences in topics meaningful for secondary education. An unavoidable aim of teacher education is to improve and develop skills in this direction. A very effective way for achieving this results is to engage teachers directly in active learning on selected and meaningful topics. They worked in small groups in an inquiry-based activity performed in conditions very similar to ones that it is usual to encounter at school (e. g. few and poor materials, missing or ill-equipped laboratories). The next step is to render teachers aware of which activities had been effective and which role had had the teacher in favouring scientific argumentation, problem solving and learning process in laboratory.

The choice of a qualitative inquiry-based exploration arises from the consideration that pre-service science teachers experienced very different undergraduate and graduate formation. Moreover, it is useful to show, especially to physics or chemistry graduate, that qualitative laboratory can be a rich experience, if it is well designed. The inquiry-based exploration is briefly described in the next section.

The laboratory was proposed within the course on Physics Lab Didactics to pre-service science teachers attending the first regular course in Formative Active Training for obtaining teacher qualification. A second group of participants were teachers with at least 3 years of teaching experience at school with a temporary position, attending a Special Qualification Course. All participants were characterized by filling an anonymous questionnaire. Analogies and differences between the two groups are described in the next section.

Results are presented in the following section. In particular, the focus is on modelling before and after the experience of a cognitive conflict by participants.

Finally in the next section, these results are compared with those obtained previously with groups of high school students and expert teachers.

All activities are performed and supported by the Italian National Plan for Science Degrees in order to foster student enrolment in basic sciences (Montalbano 2012).

2. Exploring sliding friction

Starting from the results in a recent study in higher education (Corpuz and Rebello 2011a, Corpuz and Rebello 2011b), a qualitative explorative path on friction was designed in order to connect observations and modelling in the context of secondary school and tested with students (Montalbano and Benedetti 2014).

Participants were invited to predict the behaviour of different sliding surfaces by using their previous knowledge and experience. Then, they could realize and observe what really happens. New previsions were made and checked. Some hints were given by proposing an activity designed for selecting relevant aspects and involved interaction. Their description of the phenomenon changed during this qualitative path on friction.

Participants were guided in the exploration by a detailed worksheet and supported by a researcher.

During the activity and in the following discussion, focus was put on their engagement, how to work in group, how cooperative learning can be checked and facilitated. In this way, pre-service science teachers were engaged in an active learning process and invited to reflect on their actions as students and on the effectiveness of some teaching practice with special regards to learning process in physics laboratory.

3. Participants

The laboratory on friction was proposed within the course on Physics Lab Didactics to pre-service science teachers attending the first regular course in Formative Active Training (Tirocinio Formativo Attivo, i. e. TFA) for obtaining teacher qualification. A second group of participants were teachers with at least 3 years of teaching experience at school with a temporary position, attending a Special Qualification Course (Percorsi Abilitanti Speciali, i. e. PAS). There were 65 participants, 37 of them enrolled in TFA and 28 in PAS.

Moreover, participants were enrolled for different teaching qualifications: Mathematics and Physics in secondary school of 2nd grade (9 TFA and 3 PAS) and Mathematics and Sciences in secondary school of 1st grade (28 TFA and 25 PAS).

The participants' age is reported in fig. 1. Since TFA is the only pre-service course after graduation designed for introducing to educational profession, young participants were expected. This is partially true, since their age is centred in thirty.

On the other side, PAS students are distributed from thirty to fifty with a maximum in forty confirming the fact that in Italy a part of teaching is performed by supply teachers with no teaching qualification that remains the same for a long time.

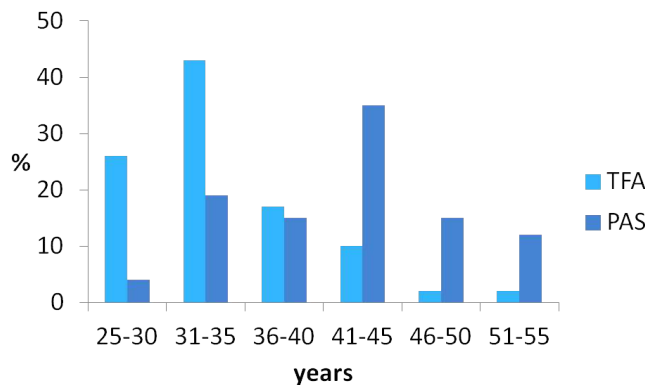

Figure 1. The age distribution of participants: pre-service teachers TFA and young teachers PAS

Many pre-service teachers had a Ph. D. degree, a qualification for teaching in other subjects (following the previous pre-service training for teachers named Scuola di Specializzazione all’Insegnamento Secondario SSIS, i.e. Advanced Schools for Teaching in Secondary Schools) or other advanced formation after the graduation. Only two PAS students had a formation post-graduation, like showed in fig. 2.

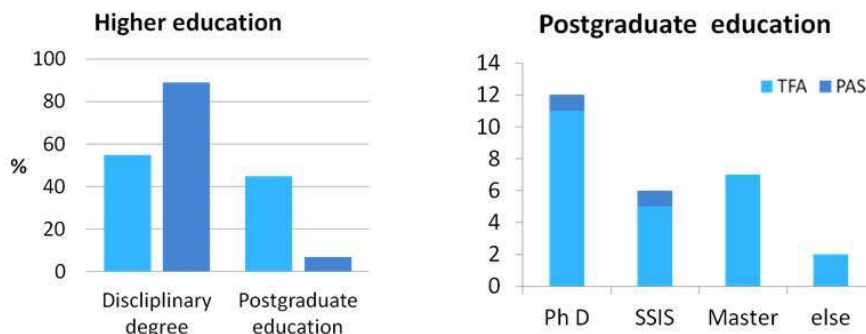

Figure 2. Participants with only a disciplinary degree compared with participants with postgraduate education (on the left), kinds of postgraduate education owned by participants (on the right).

Furthermore, TFA students were selected by an examination on disciplinary contents in order to be admitted to pre-service training.

4. Results

One important reason for improving the teaching of the physical science is the deep relationship between physics and mathematics. The description of physical processes by mathematical tools is one of the most characteristic traits of physics itself. The main goal of physics is to make predictions, to determine values of physical quantities and eventually to verify whether the assumptions of an explanation might be correct. The efficient interplay of experiment and theory needs the mathematical description through a modelling process of physical phenomena. Therefore, the role of modelling must be taken into account in the educational process (Pospiech 2008, Uhden 2012).

Models are a bridge between scientific theory and observations (Gilbert 2004). They can be simplified depictions of a reality-as-observed, produced for specific purposes, to which the abstractions of theory are then applied.

Promoting modelling in the pre-service teacher education program might affect the pre-service physics teachers' perceptions of modelling positively and lead them to use models in their teaching (Ogan-Bekiroglu 2008).

After touching surfaces with different roughness, participants predicted which one exhibits larger static friction and tested soon after their predictions. Afterward, an explicit modelling is requested and described through a graph and answering some questions in order to explicit the main aspects of the model.

Students were guided by a detailed worksheet and the qualitative exploration lasted about 90 minutes, while a tutor was available to provide clarification. All activities were realized with low-cost materials in a classroom (see fig. 3 and Montalbano 2014 for further details).



Figure 3. Surfaces proposed in the inquiry-based exploration on sliding friction: wood, sandpaper and steel.

The results from the exploring activity were examined focusing on the modelling process. In particular, the modelling performed by teachers after the initial observations and after some unexpected observations.

Modelling I

Smooth and rough wooden surfaces and different types of sandpaper were examined. Sandpaper and wood were touched, predictions on sliding behaviour for surfaces with the same and different material or roughness were requested. Soon after they tested their prediction and usually confirmed the day life knowledge, i.e. smooth surfaces slide easily than rough ones. After these observations, participants had to guess and draw how static friction depends on roughness.

The most part of participants drew a linear increasing function (some examples are shown in fig. 4 on the left). A few teachers proposed a non linear increasing function. It can be argued that participants who drew a decreasing function (fig. 4 on the right) had in mind a different behaviour for sliding surfaces that was not confirmed by the previous observations but their conviction was stronger than the direct observation, i.e. their model is in contrast with direct experience.

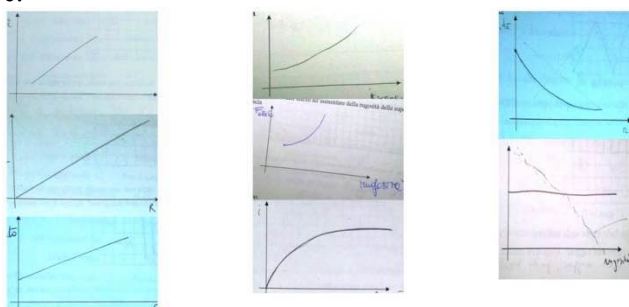

Figure 4. Modelling after first observations: linear dependence (on the left), not linear increasing functions (center), flat or decreasing dependence (on the right).

The complete results for modelling 1 is show in fig. 5.

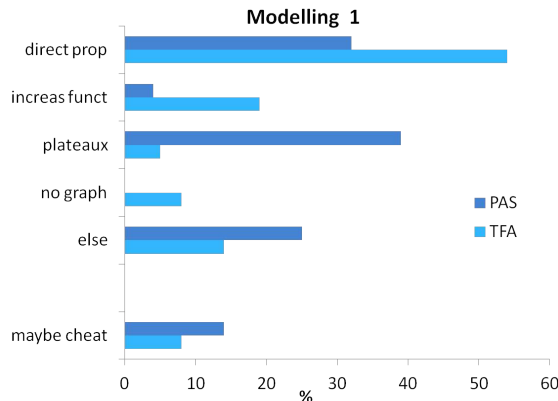

Figure 5. Modelling 1 results

Almost all teachers recognized an increasing behaviour but not everyone. Most part of TFA and a consistent part of PAS described it by using direct proportionality.

A few teachers proposed a model fully coherent with observations, i.e. increasing but not linear (there were no quantitative info) with no info on extreme cases, i.e. 0 and infinity. More than one showed a suspect graph (corrections in opposite sense usually incoherent or contrary to observation). It seemed than they cannot admit to have done an incorrect prevision even in an anonymous worksheet.

Modelling II

After touching metal surfaces with different roughness, participants predicted which one can have the max or the min static friction, soon after they tested their prediction and usually did not confirm it. In these case, almost all participants faced a cognitive conflict: rough surfaces slide easily than smooth ones.

Other activities were proposed (Montalbano 2014) suggesting the correct interaction involved in friction and correlations with apparent and real area of contact. The correct phenomenological law (Rabinowicz 1992) was shown on the left side of fig. 6.

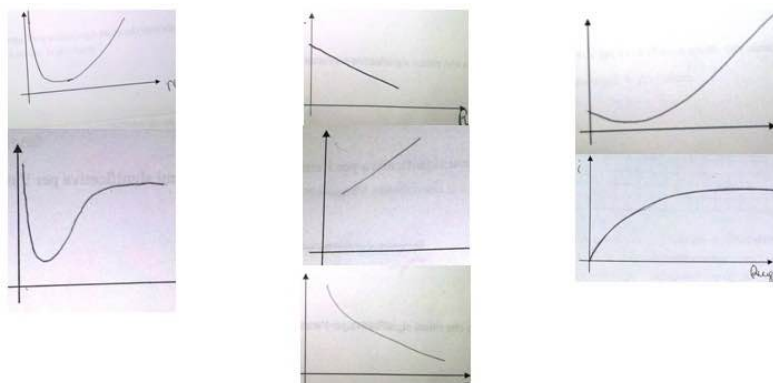

Figure 6. The correct phenomenological behavior (on the left), dependence that take in account only part of direct observation (center), other dependences (on the right).

At this point, participants could change their prediction on dependence from roughness. Some new graphs are shown in fig. 6 and the results are given in fig. 7.

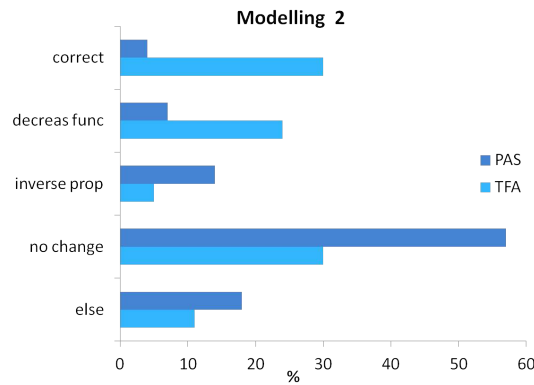

Figure 7. Modelling 2 after the full activity.

Only one teacher in PAS recognized the correct behaviour (about 35% in TFA). Math & Phys 2nd grade teachers failed in both groups.

Most part of PAS and more than 30% of TFA were unable to resolve the cognitive conflict by proposing a different model (no change).

The TFA group had reacted better, with more open mind (especially Math & Science 1st grade teachers).

5. Discussion and remarks

In order to discuss the modelling skills of pre-service teachers, it is useful to compare the results obtained by proposing the same activity to two different groups: expert teachers and students.

The qualitative explorative path on friction was designed initially for stimulating discussions in a workshop in which physics teachers and students were attending. In the workshop, expert teachers participated to the activity on friction. All expert teachers were Math & Phys 2nd grade teachers involved in teacher professional development or in pre-service education (like tutor or teacher) and their age is shown in fig. 8.

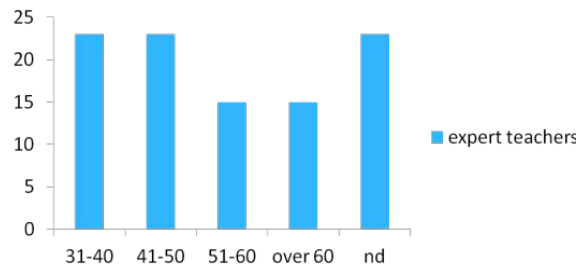

Figure 8. Age distribution for expert teachers

Expert teachers’ reactions were the starting point for this research: they were very offended to observe and answer these *obvious* questions. Their results were compared with the other groups in fig. 9.

Nevertheless, only 46% were able to connect correctly observations and models and younger teachers succeeded more than older ones. Despite this, expert teachers succeeded more than pre-service teachers.

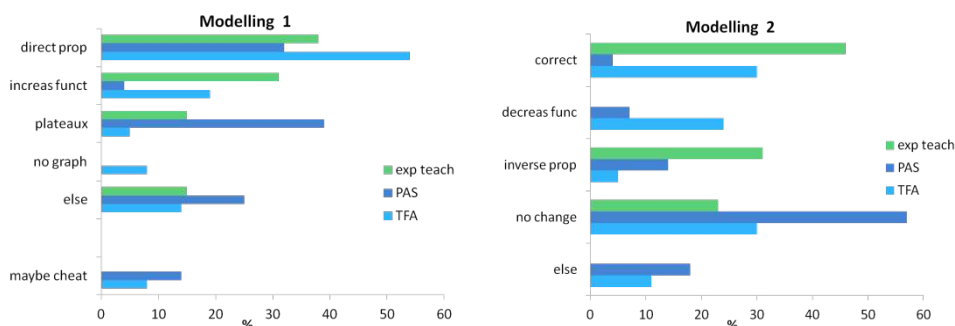

Figure 9. The results of expert teachers compared with the ones of pre-service teachers.

Two 3rd classes of a scientific high school (44 students aged 16-17), during an educational trip at department, tested the laboratory on friction. Sliding friction and Leonardo's laws were introduced, discussed and assessed in previous school time by their teacher. Their results in modelling are shown in fig. 10.

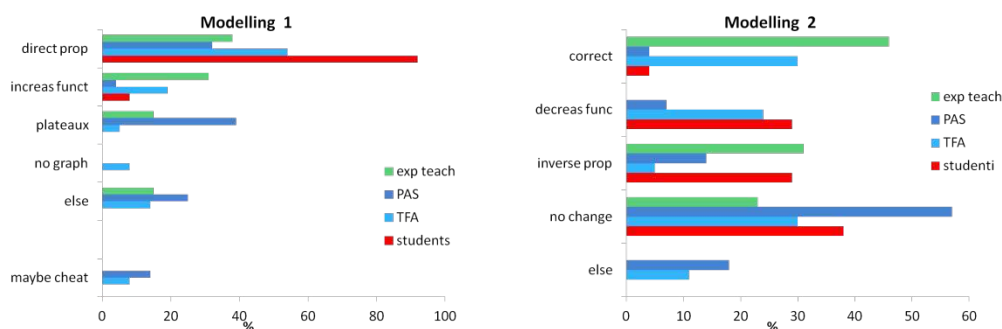

Figure 10. The results of students compared with the other groups.

High school students observed correctly phenomena in laboratory but their modelling is poor (only direct or inverse proportionality is commonly used).

Final model for students is very similar to PAS teachers but more linear (no creative model far from observations). Finally, students and expert teachers did not try to cheat.

6. Conclusions

Friction is an intriguing and difficult topic but the proposed qualitative activity was very effective and interesting for students as well as for teachers. Many participants, which were teaching, tried this activity with their classes and found it useful for promoting active learning. Moreover, this inquiry-based activity can be the starting point for introducing more advanced topic such as nanosciences, or interdisciplinary activity like how sensible is our sense of touch (Skedung 2013).

Nevertheless, more attention in the correct use of functions in mathematics, in laboratory and in modelling is requested.

Correct observations in laboratory and modelling skills are essential for transmitting scientific knowledge and methodology at school but this is an impossible aim if teachers are not aware of the importance of modelling, especially if they do not know to apply it in simple experimental contexts.

Actions for changing pre-service and in-service teachers skills in modelling are necessary and unavoidable but not easy. Participants to pre-service formation in secondary school of 2nd grade are usually mathematicians or physicists which feel their disciplinary skills and ability in modelling superabundant for teaching. The presented activity can be a starting point for improving their awareness on this important topic and for fostering their educational action in modelling.

References

- Corpuz, E. D. and Rebello, N. S. (2011a). Investigating students' mental models and knowledge construction of microscopic friction. I. Implications for curriculum design and development, *Phys. Rev. ST Phys. Educ. Res.* **7**, 020102.
- Corpuz, E. D. and Rebello, N. S. (2011b). Investigating students' mental models and knowledge construction of microscopic friction. II. Implications for curriculum design and development, *Phys. Rev. ST Phys. Educ. Res.* **7**, 020103.
- Gilbert, J. K. (2004). Models and Modelling: Routes to More Authentic Science Education, *International Journal of Science and Mathematics Education* **2**, 115–130
- Montalbano, V. (2012). Fostering Student Enrollment in Basic Sciences: the Case of Southern Tuscany. *Proceedings of The 3rd International Multi-Conference on Complexity, Informatics and Cybernetics: IMCIC 2012*, International Institute of Informatics and Systemics, 279-284
- Montalbano, V. (2014). An inquiry-based laboratory on friction. *ICPE-EPEC 2013 Conference Proceedings*, 1010-1017

Montalbano, V. and Benedetti, R. (2014). Active learning in pre-service science teacher education. *ICPE-EPEC 2013 Conference Proceedings*, 570-578.

Skedung, L., Arvidsson, M., Chung, J.Y., Stafford, C. M., Berglund, B., Rutland and M. W. (2013). Feeling Small: Exploring the Tactile Perception Limits, *Scientific Reports* 3, doi:10.1038/srep02617.

Ogan-Bekiroglu, F. (2008). Examination of Pre-service Physics Teachers' Knowledge of Models and Perceptions of Modelling. *Proceedings GIREP conference 2006: Modelling in Physics and Physics Education*, 968-972.

Pospiech, G. (2008). Promoting the competence of mathematical modeling in physics lessons. *Proceedings GIREP conference 2006: Modelling in Physics and Physics Education*, 587-595.

Rabinowicz, E. (1992). Friction Fluctuations. In Singer, I. L. and Pollock, H. M. (Eds.) *Fundamentals of Friction: Macroscopic and Microscopic Processes* (pp. 25-36) Dordrecht: Kluwer Academic.

Uhden, O., Karam, R., Pietrocola, M. and Pospiech, G. (2012). Modelling Mathematical Reasoning in Physics Education, *Sci & Educ* **21**, 485-506, doi:10.1007/s11191-011-9396-6.

Affiliation and address information

Vera Montalbano
Department of Physical Sciences, Earth and Environment
University of Siena
Via Roma, 56
53100 Siena, SI, Italy
e-mail: montalbano@unisi.it

Wave-Particle Complementarity: Teaching Quantum Physics with a Virtual Mach-Zehnder Interferometer

Jader da Silva Netto¹, Cláudio José de Holanda Cavalcanti², Fernanda Ostermann³

¹ *Post-Graduate Program in Physics Education, Federal University of Rio Grande do Sul, Brazil.*

² *Institute of Physics, Department of Physics, Federal University of Rio Grande do Sul, Brazil.*

³ *Institute of Physics, Department of Physics, Federal University of Rio Grande do Sul, Brazil.*

Abstract

We present the results of a research conducted with a computational simulation of the Mach-Zehnder Interferometer, which allows one to perform several experiments involving single photons. In this study, we have investigated how undergraduate students (pre-service teachers) adopt discursive strategies to understand the concept of wave-particle complementarity when they work collaboratively, paying special attention on the software, used as a mediational tool in these discursive interactions. Based on the Vygotsky's ideas on learning and development and assuming that language is the main cultural human mediational tool, the sociolinguistics of Mikhail Bakhtin has been adopted to increment analysis on the students' verbal interactions, which revealed interesting strategies adopted to understand the concepts involved.

Keywords

Teacher Education, Complementarity Principle, Virtual Mach-Zehnder Interferometer

1. Introduction

Researches on physics education have been conducted in the twentieth century in Brazil, pointing the need and feasibility of insertion of modern physics topics in high school level. Since the first studies related to the teaching of this subject in Brazil, conducted in mid-1990s, several possibilities to promote the insertion of this topics have been proposed (Pietrocola, 2005). Considering the period up to the present day, it can be said that there is still much to be done to put forward the consolidation of Modern and Contemporary Physics (MCP) in high school. In a country with continental dimensions like Brazil, national assessments are performed and the results reveal large learning disparities between different regions and schools (public schools have worse results if compared to private schools). There are frequently complaints about deficient conditions of schools (mainly the public ones), the low amount of physics classes and teachers' lack of self-confidence to teach MCP in their schools.

In fact, the twentieth century physics is taught in some schools, but this does not always happen. When it happens, time is usually dedicated to explore topics such as the special theory of relativity, blackbody radiation and atomic models, and some other physics topics of early twentieth century. Fundamental aspects of quantum physics are simply left out. On the other hand, one can also question about the way physics teachers are being taught in their undergraduate courses. It is common to listen teachers say that their physics courses were too much centered on mathematical procedures, most often with a considerable degree of complexity. Moreover, these approaches often ignore epistemological and ontological aspects of quantum objects, which could be helpful to conceive a more conceptual approach. The rejection feeling on many physics teachers regarding to implementation of quantum physics in the high school curriculum, may be caused due to the image that was created in their formative experience, reminds unfamiliarity with mathematical formalism and other serious difficulties (Monteiro *et al.*, 2009). Considering these difficulties, we opted to take a stance towards improvement of the initial training of physics teachers, since among the difficulties alleged by the teachers is lack of self-confidence to teach quantum physics. More familiarity with this topic can provide more confidence to teachers, leading them to feel more comfortable to teach fundamental concepts of quantum theory in high school.

Several researchers have developed studies on the teaching of quantum physics in undergraduate courses in the last decade. Among other issues, the researches are aimed to investigate students' difficulties on their understanding of the core of this theory, to conceive alternative teaching methodologies and/or to develop teaching resources. These researches include development of experimental activities (Galvez *et al.*, 2005), use of interactive tutorials (Singh, 2008), teaching of quantum interference with Virtual Mach-Zehnder Interferometer (VMZI) (Pereira *et al.*, 2009), tutorial for simulating the Stern-Gerlach experiment (Zhu and Singh, 2011), a collection of interactive animations of quantum physics and proposal of a new curriculum to teach it (Kohnle *et al.*, 2012; Kohnle *et al.*, 2014). Use of experimental activities and computational simulations as didactical resources are highlighted as ways to promote conceptual approaches to some quantum phenomena. One of these resources is the VMZI, a computational simulation of the Mach-Zehnder Interferometer, wherewith one can perform several experiments involving single photons (e.g. quantum interference, non-demolition detection, photon polarization, etc.).

2. The Virtual Mach-Zehnder Interferometer and the wave-particle complementarity

This software, developed originally in 2004 by our research group, was remodeled in 2012-2013 to account several additional phenomena. The original version was used in teaching activities on introductory quantum physics undergraduate disciplines, as part of research projects conceived by our group. With this newer version, our intent is to take a step into more advanced topics, allowing more parameter configurations. The figure 1 shows a simplified diagram of Mach-Zehnder interferometer, along with examples of interference patterns. In figure 2 is depicted the layout of the current software version. This diagram represents an overview of the interferometer. There are two input ports (I and II) and two output ports (1 and 2). A monochromatic photon source is placed at input port I and screens at output port 2. To avoid unnecessary physical complications, we consider that the beam splitters (BS_1 and BS_2) are cubic and symmetric (Zeilinger, 1981; Hamilton, 2000; Holbrow *et al.*, 2002). Also, we consider that each path, A or B, has equal lengths. Among other possibilities, it's possible to change values of reflection (R_1 and R_2) and, thus, of transmission coefficients ($T_1 = 1 - R_1$ and $T_2 = 1 - R_2$) in both beam splitters.

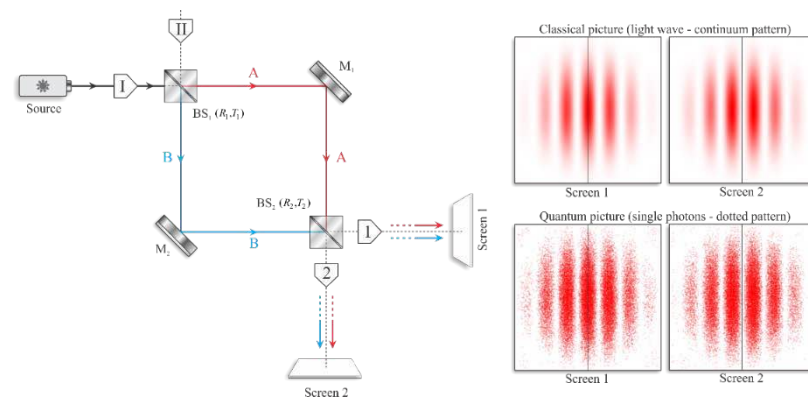

Figure 22. Mach-Zehnder interferometer with symmetric unbalanced cubic beam splitters BS_1 and BS_2 , with reflection (transmission) coefficient R_1 ($T_1 = 1 - R_1$) and R_2 ($T_2 = 1 - R_2$), respectively. Two input ports (I and II) and two output ports (1 and 2) are available. A light source is placed at input port I and screens are placed at the output ports 1 and 2 to observe the interference patterns. Examples of interference patterns is shown at right, for classical and quantum pictures (in the case of a balanced beam splitters, i.e. $R_1 = R_2 = T_1 = T_2 = 0.5$). The vertical line at the centre of each screen acts as an aid to visualize that interference pattern on screen 1 is inverted related to pattern on screen 2.

For values other than 0.5 for reflection (and transmission) coefficient, the beam splitters become *unbalanced* and photon path information becomes available (in this case, it is possible to get knowledge about the path, A or B, associated to the photon inside the interferometer, decreasing the contrast of interference pattern). The possibility of choosing the value of reflection coefficient for each beam-splitter opens the possibility to explore and investigate students responses to teaching activities focused on the quantitative wave-particle complementarity (Li *et al.*, 2012). In Mach-Zehnder interferometer, the complementarity between the wavelike behavior and particle-like behavior can be stated, according to Auletta *et al.* (2009, p. 19), as follows: “the complete knowledge about the path is not compatible with the presence of interference”. Here,

the word “path” should be understood as being associated with a translational state of the photon in the interferometer, as defined by Dirac (1958, p. 7). Complementarity is one of the main thesis of Copenhagen Interpretation of quantum Physics. The wave particle-complementarity is the most common kind of complementarity that appears on physics textbooks. Thus, we made the option of address the wave-particle duality in the light of Copenhagen Interpretation. Despite no agreement exists on which is the best interpretation of quantum physics, Copenhagen Interpretation seems to be the one which attracts more scientists on this research field, followed by the Many-Worlds Interpretation (Schlosshauer *et al.*, 2013). As stated by Muynck (2004, pp. xxi, on preface), without interpretations, quantum physics would be only mathematics. To implement meaning and “make it physics”, an interpretation is needed “in the sense of a mapping of entities of the mathematical formalism into reality is indispensable”.

A thought experiment to observe intermediate quantum interference phenomena was first proposed by Wootters and Zurek (1979) and, since then, complementarity principle has gained wide attention. Among others, Englert (1996) obtained a general duality relation between visibility of interference pattern and path distinguishability in the context of two-way interferometers. These two quantities are very important to quantify particle-like and wavelike behavior of the quantum object, especially in intermediate situations where the visibility is less than one. The path distinguishability can be understood as a physical parameter that measures the degree of particlelike character of the quantum object (Greenberger and Yasin, 1988). It is related also to the maximum probability of make a correct choice about the path associated to a photon that produced a particular mark in a screen. In the Mach-Zehnder interferometer, it can be shown that the distinguishability in each screen is given by $\mathcal{D}_1 = |R_2(1 - R_1) - R_1(1 - R_2)|/[R_2(1 - R_1) + R_1(1 - R_2)]$ on screen 1 and $\mathcal{D}_2 = |R_1R_2 - (1 - R_1)(1 - R_2)|/[R_1R_2 + (1 - R_1)(1 - R_2)]$ on screen 2. Moreover, it can be shown that the maximum probability of making the right choice about the path in the interferometer associated to the photon that produced a mark on the i th screen is $P_{iS} = (1 + \mathcal{D}_i)/2$, in which \mathcal{D}_i is distinguishability in detector or screen i ($i = 1, 2$) and $0 \leq \mathcal{D}_i \leq 1$.

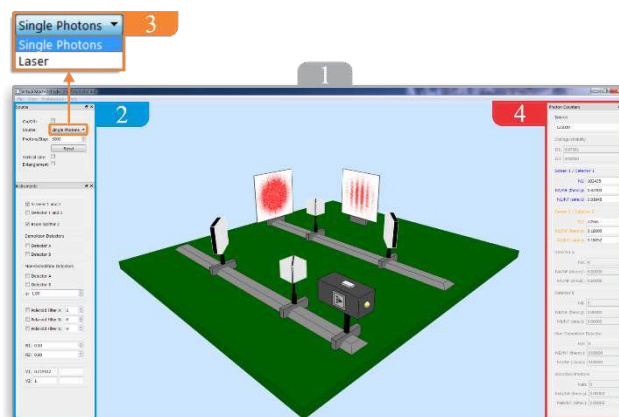

Figure 23. Capture of the software interface showing one of its possible layouts (1). In (2), we show how the classical (option Laser) or quantum (option Single Photons) pictures of interferometer can be selected – dropdown options are in detail in (3). Also in widget (2), input values of parameters (e.g R_1 and R_2) can be entered. Numerical values of interference visibility in each screen appear in the bottom of this widget. In (4) are shown all possible photon counters, providing theoretical predictions and results of simulations.

The visibility, or contrast of the interference pattern, can be thought as a physical parameter that quantifies the degree of wavelike character of quantum object (Greenberger and Yasin, 1988). It can be shown that the visibilities in VMZI on each screen is given by $\mathcal{V}_1 = 2\sqrt{R_1R_2(1 - R_1)(1 - R_2)}/[R_2(1 - R_1) + R_1(1 - R_2)]$, on screen 1, and $\mathcal{V}_2 = 2\sqrt{R_1R_2(1 - R_1)(1 - R_2)}/[R_1R_2 + (1 - R_1)(1 - R_2)]$, on screen 2. Analogous to distinguishability, $0 \leq \mathcal{V}_i \leq 1$. The complementarity between wavelike and particle-like behaviors of the quantum object in VMZI is quantitatively described by $\mathcal{V}_i^2 + \mathcal{D}_i^2 = 1$, on each screen. If we consider the maximum distinguishability (equal to 1), it means that there is complete information about the path and this implies zero visibility (no interference or full particlelike behavior). In the complementary situation, there is no path information available or, in other words, distinguishability is zero, implying that the visibility will be maximum (interference pattern with maximum contrast, indicating full wavelike

behavior). If we consider only these two extreme cases, path distinguishability, or ability to take a “trajectory” inside the interferometer (a particle-like behavior) and ability to produce interference pattern (wavelike behavior) are complementary or mutually exclusive behaviors. It is not possible to configure an experiment so that all of the quantum objects exhibit these two behaviors at once. However, the most interesting cases to be studied are exactly those where visibility and distinguishability values are smaller than unity and satisfy the quantitative relation $\mathcal{V}_i^2 + \mathcal{D}_i^2 = 1$ ($i = 1, 2$). For the cases in which path information is partial and the interference pattern has reduced visibility, the wavelike and particlelike behaviors appear simultaneously. This is a generalization of the original conception of Bohr's complementarity between the corpuscular and wavelike nature, present in most physics textbooks.

3. Theoretical framework

In this paper we investigated ways in which undergraduate students (pre-service teachers) can understand the concept of wave-particle complementarity, paying special attention on how the software, as a mediational tool, acts in order to promote creation of the Zone of Proximal Development (ZPD) when they collaboratively work in pairs (Rio and Álvarez, 2007). Coherently with this aim, the theoretical framework adopted in this study is the Vygotsky's mediation theory, revisited by James Wertsch and other scholars. This theory assumes *mediated action* as the most important aspect in Vygotsky's theory: any social action performed by humans uses mediational tools (Wertsch, 1993). The VMZI is a mediational tool that allows interaction between the students and simulated physical phenomena. Furthermore, language is the main human cultural mediational tool used in social contexts – discursive interactions between pre-service teachers will be our main focus of analysis (Vygotsky, 1978). Assuming that language is the main human cultural mediational tool, the sociolinguistics of Mikhail Bakhtin has been adopted to perform discourse analysis on the students' interactions (speech and discursive interactions), pointing the relationship between their discursive exchanges and the organization of their actions during the teaching activities (Bakhtin, 1997). According to Bakhtin's theory of enunciation, the speeches are not associated only with one voice but at least two voices. This process, which one voice is not the only responsible for the creation of an utterance, but in fact the words are part of another discourse, Wertsch (1993) calls interanimation. This multiplicity of voices that permeate the discourse indicates that it is not strictly restricted to the context in which it occurred. The speech carries relationships, sometimes almost imperceptible, with ideologies, institutional norms, culture, aspects that may be far away, spatially or temporally, from the context in which the speech occurs.

4. Research methodology and data analysis

The teaching activities were conducted with students organized in pairs. Each of these pairs of students received an experimental guide with questions to be answered during the simulation on VMZI. The dialogues between students during classroom were recorded in audio and video. In this paper, we present some discursive exchanges of a pair of students (S_7 and S_8) and the analysis that we perform is mainly focused on two central bakhtinian concepts: counterwords and voices.

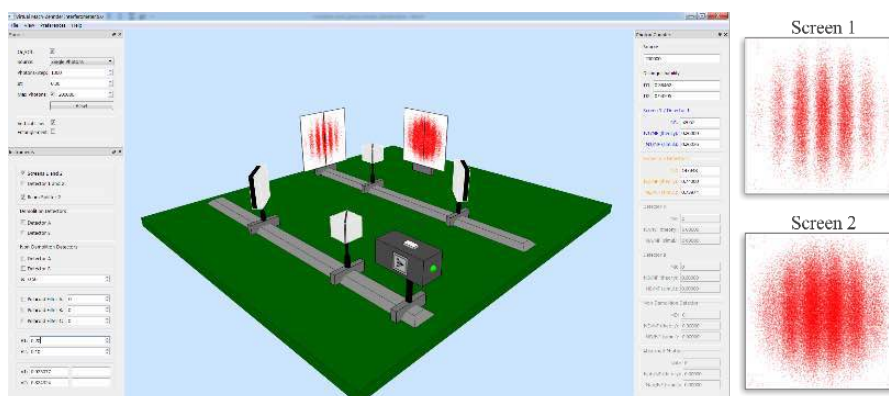

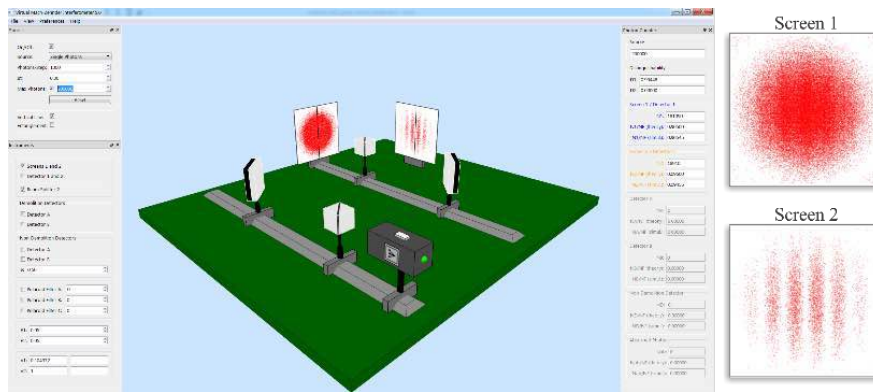

Figure 24. Upper: Mach-Zehnder interferometer with interference patterns obtained for $R_1 = 0.20$ and $R_2 = 0.10$. Lower: Mach-Zehnder interferometer with interference patterns obtained for $R_1 = 0.95$ and $R_2 = 0.05$.

Dialogues in classroom

After some introductory classes, the teacher presents situations on VMZI. One of these situations is depicted in upper part of figure 3, mediated by a text guide, in which students are asked to explain the interference patterns on the screens when the reflection probabilities of the beam splitters are $R_1 = 0.20$ and $R_2 = 0.10$, as shown in upper part of figure 3.

1. S8: Here [screen 1] the visibility is greater than in the other [screen 2]. The distinguishability is the opposite. It is larger in the screen 2. Increase the visibility leads to decrease of distinguishability.
2. S7: Yes.
3. S8: Increased visibility makes the distinguishability decreases.
4. S7. No. *The observer determines the distinguishability* before, at the beginning [of experiment].
5. S8: How? I don't understand.
6. S7: Is the observer who determines it. Do you remember that the teacher said? *If you put a detector, you change the visibility.*
7. S8: (...) Okay. But, how do I do it? How do I choose the distinguishability?
8. S7: Yeah, more or less. Let me note here. *It has interference. It is wavelike behavior.*
9. S8: (...) Oh, here [screen 1] it is difficult to know the path.
10. S7: Yes, it is. The visibility is 0.92.

The student S8 shows trouble on understanding quantitative wave-particle complementarity. Although he has correctly contrasted the decrease of visibility when the distinguishability increases, it is clear that he does not understand S7's utterance on line 4 (in this specific situation, the distinguishability has been defined on preparation of the experiment, choosing the parameters R_1 and R_2 of the beam splitters). Is S7 who alerts S8 about this possibility (lines 4 and 6) as well about the more prominent wavelike of photons that hit screen 1 (line 8). Here, S7 assumes the role of more capable peer, showing more mastering on semiotic reasoning about the phenomena and helping to open the ZPD between him and S8. Student S7 interanimates his voice with a voice closest to experts' voices, since he has some fluency with terms like *observer* or *wavelike behavior* and answering S8 (line 9) correctly about the lack of path information on screen 1, evoking the concept of *visibility* (line 10). Possibly textbooks or a deepest understanding of teacher introductory classes inspired him. His voice interanimates also with S8's voice, taking an actively responsive stand on dialogue, conducting it. The teacher does not even take part on this dialogue and the process was carried out only guided by S7 with clear mediation of the VMZI, as psychological and technical tool. The psychological aspect refers to semiotic dimension, with its available semiotic resources, most of pictorial nature, like the interference patterns or the 3D representation of the interferometer and its components as a virtual microworld. These semiotical resources allow students to reason about and interpret the results of their actions on the software in the light of quantum physics concepts like distinguishability, for example. The technical aspect refers to the fact that VMZI allows concrete actions – e.g., choosing different parameters for both beam splitters – on a virtual world, where the interferometer is the main virtual component.

In the sequence of activity, the students are asked to change the reflection coefficients for $R_1 = 0.95$ and $R_2 = 0.05$, as shown in the lower part of figure 3. Again, they were asked about distinguishability of the path and formation of the pattern of detections.

11. S8: I don't believe. (...) Now it's all mixed.
12. S7: (...) It is very erased here [screen 2]. But the pattern is more clear than other.
13. S8: It is erased because has only 18 percent of the photons here. What did he ask?
14. S7: It's that thing again. It has interference on screen 2 and thus the distinguishability is zero.
15. S8: What is the question?
16. S7: He asked if it is wave or particle. You have to talk about the information available.
17. S8: (...) On screen 2 we have wavelike behavior, then disappear the interference. I think it is strange, because photons are particles.
18. S7: But is particle on screen 1. Has [almost] no interference.
19. S8: ... Yeah, I guess that's it. Some photons are particles and other photons are waves.
20. S7: Yeah, but you have to talk about the information.
21. S8: What information?
22. S7: The information about the path of the photons.
23. S8: (...) 95 percent [of photons] are reflected on the first beam-splitter and goes through this path [path A]. Do you agree with this?
24. S7: Yes, because they suffer reflection. The same in the second beam-splitter. This is it. Most photons hit screen 1. We know [much more about] the path of the photons detected here.
25. S8: ... So, let's write down this sentence.
26. S7: Okay, this is the partial information.
27. S8: We have no sure for every photon.
28. S7: Is not it.
29. S8: Half of photons are wave and other half is particle.
30. S7: No, no, no. You are confuse. We have partial information available for all photons, but we do not know exactly where the photons will be detected. We know only the probability.
31. S8: This depends if they are wave or particle?
32. S7: No. Yes. It's almost this.

In this interaction, again S7 plays the role of more capable peer in several utterances (lines 14, 16, 20, 22, 24, 26, 28, 30). This role is important not only for S8, but for himself. He develops linguistic (discursive) strategies not only aiming convinces S8, but to reason about the complex situations involved here. Again, he interanimates his voice with voices close to expert voices, embedded with linguistic maturity to ground his reasoning about the situation in terms of *path information*, explaining the interference patterns supported by the concept of path distinguishability and correctly associating it with wavelike or particlelike behavior (lines 14, 18, 24 and 30). Student S8 seems to adopt a classical reasoning in some utterances, considering photons as particles like bullets, showing difficulty to understand interference on screen 2 (line 17). After discussion with S7, he seems to be more comfortable with the idea of photon dual behavior on that screen, although he still seems to consider this issue in a naïve way.

5. Conclusions

The analysis presented in this paper reveals some interesting results that can help teachers to identify problems on the students understanding of wave-particle complementarity of photons and therefore to adopt strategies that promote their learning. The speech of student S8 reveals that there is an underlying tendency to attribute particlelike behavior to the photons, even in situations where wavelike behavior is evident. Although the particlelike behavior attributed to the photons doesn't indicate that student adopted truly a 'corpuscular interpretation', to fall back on to this way to represent the photons leads to difficulties in the understanding of the quantitative complementarity principle. In discursive interactions like these presented here, the role of more capable peer is evidenced as very important not only for the other element of the pair (the less capable peer), but for himself. Is the dialogical interaction with the other that creates a ZPD and

leads both to better understand the concepts involved by negotiating meanings and to organize their actions along the teaching activities. The mediational role of IVMZ is clearly important on these processes. Furthermore, studying the discursive strategies used by pre-service teachers to understand the concepts addressed here, it can help to improve the teaching of quantum physics in pre-service teacher formation programs. The conclusions of this study lead us also to new questions about the learning of others fundamental concepts of quantum physics, such as nonlocality. What can IVMZ reveal in relation to the process of student's understanding even more counterintuitive situations, such as quantum entanglement? How does particlelike behavior attributed to photon can interfere with the understanding of quantum entanglement? These questions will be a continuation of this work, in which the software will be updated to allow the simulation with pairs of photons in entangled polarization states.

Acknowledgment

The authors of this paper thanks the Brazilian National Research Committee (CNPq) for partial financial support.

References

- Auletta, G., Fortunato, M., and Parisi, G. (2009). *Quantum Mechanics*, Cambridge University Press, New York, US.
- Bakhtin, M. M. (1997). *Estética da criação verbal*, Martins Fontes, São Paulo, BR.
- Dirac, P. A. M. (1958). *The principles of quantum mechanics*, Oxford University Press, London, UK.
- Englert, B.-G. (1996). Fringe visibility and which-way information: an inequality. *Physical Review Letters*, **77**, 2154-2157.
- Galvez, E. J., Holbrow, C. H., Pysher, M. J., Martin, J. W., and Courtemanche, N. (2005). Interference with correlated photons: Five quantum mechanics experiments for undergraduates. *American Journal of Physics*, **73**, 127-140.
- Greenberger, D. M., and Yasin, A. (1988). Simultaneous wave and particle knowledge in a neutron interferometer. *Physics Letters A*, **128**, 391-394.
- Hamilton, M. W. (2000). Phase shifts in multilayer dielectric beam splitters. *American Journal of Physics*, **68**, 186-191.
- Holbrow, C. H., Galvez, E., and Parks, M. E. (2002). Photon quantum mechanics and beam splitters. *American Journal of Physics*, **70**, 260-265.
- Kohnle, A., Cassettari, D., Edwards, T. J., Ferguson, C., Gillies, A. D., Hooley, C. A., Korolkova, N., Llama, J., and Sinclair, B. D. (2012). A new multimedia resource for teaching quantum mechanics concepts. *American Journal of Physics*, **80**, 148-153.
- Kohnle, A., Inna, B., Dan, B., Mark, E., Aleksejs, F., Pieter, K., Gytis, K., Martynas, P., Derek, R., and Elizabeth, S. (2014). A new introductory quantum mechanics curriculum. *European Journal of Physics*, **35**, 015001.
- Li, L., Liu, N.-L., and Yu, S. (2012). Duality relations in a two-path interferometer with an asymmetric beam splitter. *Physical Review A*, **85**, 054101.
- Monteiro, M. A., Nardi, R., and Bastos Filho, J. B. (2009). A sistemática incompreensão da teoria quântica e as dificuldades dos professores na introdução da Física Moderna e Contemporânea no Ensino Médio. *Ciência & Educação*, **15**, 557-580.
- Muynck, W. M. (2004). *Foundations of quantum mechanics, an empiricist approach*, Springer Netherlands, Dordrecht.
- Pereira, A. P., Ostermann, F., and Cavalcanti, C. J. H. (2009). On the use of a virtual Mach-Zehnder interferometer in the teaching of quantum mechanics. *Physics Education*, **44**, 281-291.
- Pietrocola, M. (2005). Modern physics in brazilian secondary schools. *Proceedings of the International Conference on Physics Education*, ICPE. retrieved from <http://files.eric.ed.gov/fulltext/ED498297.pdf>
- Rio, P. d., and Álvarez, A. (2007). Inside and outside the Zone of Proximal Development: an ecofunctional reading of Vygotsky. In H. Daniels, M. Cole & J. V. Wertsch (Eds.), *The Cambridge companion to Vygotsky* (pp. 276-303). New York: Cambridge University Press.

Schlosshauer, M., Kofler, J., and Zeilinger, A. (2013). A snapshot of foundational attitudes toward quantum mechanics. *Studies in history and philosophy of science part B: studies in history and philosophy of modern physics*, **44**, 222-230. doi: 10.1016/j.shpsb.2013.04.004

Singh, C. (2008). Interactive learning tutorials on quantum mechanics. *American Journal of Physics*, **76**, 400-405.

Vygotsky, L. S. (1978). *Mind in society: the development of higher psychological processes* (2 ed.), Harvard University Press, London, UK.

Wertsch, J. V. (1993). *Voces de la mente: Un enfoque sociocultural para el estudio de la Acción Mediada* (A. Silvestri, Trans.), Visor Distribuciones, Madrid.

Wooters, W., and Zurek, W. (1979). Complementarity in the double-slit experiment: quantum nonseparability and a quantitative statement of Bohr's principle. *Physical Review D*, **19**, 473-484. doi: 10.1103/PhysRevD.19.473

Zeilinger, A. (1981). General properties of lossless beam splitters in interferometry. *American Journal of Physics*, **49**, 882-883.

Zhu, G., and Singh, C. (2011). Improving students' understanding of quantum mechanics via the Stern–Gerlach experiment. *American Journal of Physics*, **79**, 499-507.

Affiliation and address information

Jader da Silva Netto

IFRS (Federal Institute of Education, Science and Technology of Rio Grande do Sul)

Education Department

Avenue Osvaldo Aranha, 540

95700-000 Bento Gonçalves, RS, Brazil

e-mail: jader.neto@bento.ifrs.edu.br

The PROFILES Approach to Teaching and Learning Physics in Slovenia

Jerneja Pavlin, Iztok Devetak

University of Ljubljana, Faculty of Education

Abstract

The Faculty of Education from the University of Ljubljana participates in the FP7 project Professional Reflection-Oriented Focus on Inquiry-based Learning and Education through Science (PROFILES). The project promotes Inquiry-Based Science Education (IBSE) through raising science teachers' self-efficacy and promoting a better understanding of changes in teaching science in schools and the value of stakeholder networking. The teachers' professional development programme started in the school year 2011–12. In Slovenia, 45 science teachers invited from primary and secondary schools participated in the project in the school year 2011–12 and 33 in the school year 2012–13, respectively. Teachers formed small groups (3–4 members) according to the level of education at which they teach (primary and secondary) and according to the subjects they teach (biology, chemistry, physics, or general science). Every small group developed PROFILES modules considering the PROFILES philosophy and the aims of the national curriculum. The teachers of physics and general science designed several PROFILES learning modules and three of them are presented in this paper. The topics in the modules presented were sound ("Can I represent a whole orchestra?"), simple machines ("Why should I sweat if it can be done with machines?"), and Ohm's law ("Resistance, current, and voltage: brothers from the same house?"). Modules were applied in the school environment. On average, students reached comparable achievements in a knowledge test based on the PROFILES approach to teaching and the classical approach. Based on the collected data, a conclusion was drawn that the IBSE approach was accepted among Slovenian physics teachers involved in the project. Teachers also reported that this approach presented a challenge for them as well as for the students, especially for the gifted.

Keywords

PROFILES, inquiry-based science education, teaching modules, sound, simple machines, Ohm's law

1. About the PROFILES project

The project Professional Reflection-Oriented Focus on Inquiry-based Learning and Education through Science (PROFILES) is a four-year project funded by the FP7 programme of the European Commission which has started in December 2010. It promotes inquiry science education and teacher partnership. The European project involves the participation of 21 institutions from 19 different countries (Figure 1; Bolte et al., 2012). The project is coordinated by the Division of Chemistry Education of the Freie Universität university in Berlin. One of the cooperating institutions is the Slovenian Faculty of Education (University of Ljubljana). The national coordinator in Slovenia is associate professor for chemical education Iztok Devetak. The aim of the project PROFILES is to promote teaching and learning of science using inquiry-based science education (IBSE) approach. The self-awareness of the teachers plays an important role, because it is necessary to include innovative and effective teaching strategies into teaching. For this reason, every national group organized a Professional Development Programme (PDP) that was designed to meet the criteria of the PROFILES philosophy according to which the students¹ are presented with a motivating, socio-scientific problem and engaged in discipline-specific but also general skill-developing inquiry activities in order to solve a problem. The aim of the project is also to raise teacher skills in developing creative, scientific problem solving, and socio-scientific decision abilities of the students (Bolte et al., 2012).

¹ For the sake of clarity, the term *student* is used throughout the text, referring to both students of primary and secondary schools.



Figure 1. Spider-web of European countries cooperating in the project PROFILES (Bolte et al., 2012).

In the course of PDP, the teachers develop at four different levels. They first learn about the PROFILES approach for designing teaching modules at the faculty as learners. Then they design modules and apply them in classrooms as effective teachers. Later, they evaluate their work as reflective practitioners. The last role they assume is teacher as a leader. They play this role while teaching other teachers about the PROFILES approach. However, when they present the approach, a chain reaction of exchanging experience and good practices including inquiry approach is triggered (Bolte et al., 2012).

It is also known that creative, problem-based, and socio-scientific environment promotes students' motivation to learn science content. At this point, it is important to monitor internal (the students realize the meaning of learning) and external motivation (the teachers or learning materials encourage students to learn) of the students to learn science on different levels of education. Only a well-educated teacher can create an appropriate environment for students to learn science which promotes the development of competencies, such as decision-making skills and problem solving. This fits with the ideal outcome of the project: school science related to 21st century science and incorporating interdisciplinary socio-scientific issues and IBSE-related teaching (Holbrook and Rannikmae, 2012).

2. The PROFILES modules

The PROFILES modules are originally based on PARSEL approach (Parsel, 2014). In Slovenia, we also used the GALC (Guided Active Learning of Chemistry) approach to modify the modules. GALC is similar to the POGIL teaching and learning strategy. POGIL is an acronym of Process-Oriented Guided Inquiry Learning based on the cognitive theories and the research of learning strategies developed in the USA for university level chemistry (Devetak et al., 2014). If the students are involved in the learning process, they have a possibility to build up their knowledge. The modules based on the POGIL approach are student-centred where the teacher is considered a facilitator of learning. The POGIL modules enable the students to build understanding, develop higher-level thinking skills and lead them to the ability to learn and apply knowledge in a new context (Hanson, 2006).

An IBSE approach promotes the building of knowledge trying to find a scientific answer to a scientific question in small research projects groups. The IBSE approach is learner-centred meaning that students are the guided designers and authors of the experiments that lead them to meaningful measurements and observations. These enable drawing conclusions about physics laws or understanding physical concepts prescribed by a standard school curriculum (Arlegui et al., 2010; Rauch and Dulle, 2012).

The teachers involved in the project developed PROFILES modules in small groups according to the PROFILES philosophy (Devetak et al., 2012; Holbrook and Rannikmae, 2012). Groups (3–4 members) were formed according to the level of education at which they teach (primary, secondary) and according to the subject (physics, chemistry, biology, and general science) they teach. A consultant from the faculty was included in every small group. The role of the consultant was to lead teachers during their work, share knowledge about the PROFILES approach and provide them with insights into difficulties at learning (and misconceptions) of certain physics concepts as perceived by the researchers. The teachers considered these while preparing their modules according to their own assessment. The PROFILES modules have specific parts: a front cover page and 4 sections: (1) “Student activities”, (2) “Teaching guide”, (3) “Assessment” and (4) “Teacher’s notes”. The front cover page includes a title of the module composed as a problem-posed question, the subject area and the age level of students, an abstract, the listed sections of the module, an acknowledgement with listed authors of the module, the learning objectives and competencies, the curriculum content, the types of activities, the anticipated time and the prior knowledge.

The section (1) “Student activities” includes a detailed description of the scenario and student activities, including the tasks. The section begins with a module title formulated as a problem question, which refers to a practical context. The question “Why do I learn this?” reveals the content in a socio-scientific context, which also briefly describes the possible answers to the question from the title. This is followed by the categories “Aims” and “Learning outcomes”. The aims are linked to the curricula and competencies. “Prior knowledge” shows a list of concepts necessary to understand so that student can easily follow the “Student tasks” of the module. “Literature” offers a list of additional sources where student can find information about the topic. This is followed by the “New concepts” list, which does not include definitions and descriptions (Holbrook, 2012). “Student tasks” are the most important part of the “Student activities” section. They consist of 3 parts. The first part (I.) includes scenario for leading a conversation related to student consideration of the socio-scientific context of the module. The second part (II.) consists of the step-by-step instructions for learning by inquiry and the questions related to the steps. In this part, we find practical experiments and questions which lead the work. In the end of the second part of “Student activities”, the following is listed: “Key questions”, “Exercises”, and “Do I understand?”. The students are asked to read the text thoroughly and then discuss it in groups using “Key questions”. While reading the students analyse the data and find the connections and relationships between them. This type of approach helps the students develop higher levels of thinking. The knowledge gained is evaluated by means of “Exercises” containing simple tasks. The work with “Exercises” influences the student self-confidence. The tasks in the section “Do I understand?” are a series of questions which direct the students to new knowledge and self-evaluation. The third part (III.) of “Student tasks” includes “Problems”. The “Problems” are related to the socio-scientific context of the module with the aim that the students solve the problem by decision making, synthesis and evaluation of the knowledge gained and by the transfer of this knowledge into a new context using specific strategies (Bolte and Holbrook, 2012; Devetak et al., 2014, Holbrook, 2012; Holbrook and Rannikmae, 2012). The section (2) “Teaching guide” provides guidance to the teachers on how to use the module in their teaching. It also includes the learning objectives of each lesson and competencies suggested. “Assessment” is section (3) of the PROFILES module and has 3 units: (i) the assessment based on the skills acquired; (ii) the assessment by lessons; and (iii) the assessment based on the teacher strategy. Section (4) “Teacher notes” gives background information to the teacher, such as additional information about the content, including the solved “Student tasks” from the section (1) of the module (Holbrook, 2012).

3. The PROFILES project in Slovenia

Slovenia has approximately 2 million inhabitants, 450 primary schools and 183 secondary schools. The number of teachers per school years included in the Slovenian PROFILES spider web is shown in Table 1. In school year 2011–12, 45 teachers invited from 35 schools participated in the project. They were divided into small groups regarding their professional science orientation (biology, chemistry, physics, and general science) and their teaching level (primary or secondary school). A group of teachers supervised by the consultant who was appointed by the faculty developed an innovative teaching approach following the PROFILES framework. The teachers cooperated in workshops and meetings and helped gathering and reporting data as well as giving feedback with a portfolio (Jurišević et al., 2012). In the school year 2012–13, 10 teachers were members of the first PROFILES generation, while others were fresh enthusiastic teachers willing to participate and grow familiar with the PROFILES approach. The teachers who participated in the previous year were asked to function as leaders in the groups of new teachers. In the school year 2013–14, only the teachers who already participated in the project were invited. Their tasks were to upgrade and revise the existing modules, implement the modules and organize regional workshops about the PROFILES approach. The national coordinator of the project operates in the field of chemistry, which unquestionably influenced the number of participating chemistry teachers. However, enthusiastic primary school physics teachers were involved in the project as well; 4 in the first year, 9 in the second year and 1 in the third year, respectively (Table 1).

Table 1: Number of in-service and pre-service teachers included in the PROFILES network separately for each school year by professional science orientation and teaching level (Metljak, 2014)

Subject	School level	School year			Total
		2011–2012	2012–2013	2013–2014	
<i>Biology</i>	Primary	9	5	3	17
	Secondary	/	1	/	1
<i>Chemistry</i>	Primary	25	13	8	46

	Secondary	5	1	/	6
<i>Physics</i>	Primary	4	9	1	14
	Secondary	2	/	/	2
<i>General science</i>	Primary	/	4	1	5
<i>Pre-service primary school teachers (general science, chemistry, environmental education)</i>		/	11	43	54
Total		45	44	56	145

4. The PROFILES physics modules in Slovenia

The physics teachers who cooperated in the project designed the PROFILES teaching modules covering a series of topics from the Slovenian syllabus for physics in elementary and secondary schools (Planinšič et al., 2008; Verovnik et al., 2011). The modules are related to the following topics: pressure, density, friction, resistance, motion, machines, electric charge, and electric resistance. A group of teachers in the field of general science designed a PROFILES module about sound. Three examples of the physics modules for primary school are presented in this section. They can be accessed on a Slovenian web page of the PROFILES project <http://www2.pef.uni-lj.si/kemija/profiles/moduli.html>. The title of the module is formed as a question and the subject to which a module refers (physics, chemistry, biology, or general science) and topic from the national curricula appear next to the title (Skvarč et al., 2011; Verovnik et al., 2011).

Can I represent a whole orchestra? (7th class, Science)

In the module “Can I represent a whole orchestra?”, the students, who already possess basic theoretical knowledge about sound, test their knowledge through experimental work (Figure 2). The knowledge about the properties of sound enables the students to investigate how sounds change due to the size of the musical instruments. The students explore string instruments, chimes bars, flutes, and drums. Every member of the group creates their own instrument. The students learn to play the instruments created. The module finishes with a short concert of the class orchestra.

Why should I sweat if it can be done with machines? (9th class, Physics)

This inquiry-based learning PROFILES module starts with a question “Why should I sweat if it can be done with a machine?”. It leads the students into a world of simple machines used by everyone without knowing why do they make our work easier (Figure 3). Simple machines are a physics topic related to work and energy. The module presents a lever (1st class), a pulley, and a slope. The students gain experimental and theoretical knowledge that simple machines simply said make it easier for people to perform work. For example, a machine can help people move or lift a heavy object, change the direction of a force, lift something heavier that a person can lift by themselves, etc. In the end of the module, the students should be able to decide and justify their choice of a machine for a given task.

Resistance, current, and voltage: brothers from the same house? (9th class, Physics)

The module “Resistance, current, and voltage: brothers from the same house?” refers to the fact that the quantities electric current, voltage, and resistance are related. Their relationship is described by Ohm’s law (Figure 4). The experiments suggested lead students to the conclusion described above. Considering Ohm’s law, a person can design electrical circuits and understand the behaviour of different electric elements. The module also presents the limitations of Ohm’s law for different electric elements. The students also learn to use the resistor colour code.



Figure 2. A poster about the teaching module "Can I represent a whole orchestra?" was prepared by a teacher from the group that designed the module about sound. The poster presents 4 experimental activities related to different instruments: string instruments, chimes bars, flutes, and drums. The teachers report that the PROFILES approach of learning by inquiry is especially successful with the gifted students. For this reason, the poster was prepared and presented at the conference Motivating Gifted Students for Learning Science in 2013. The co-organizer of the conference was the PROFILES team (Dominić-Radivojević et al., 2013).

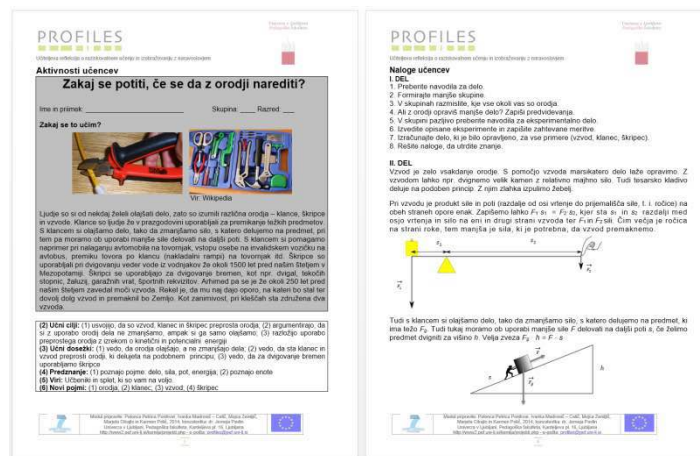

Figure 3. "Student activities" section from the PROFILES module "Why should I sweat if it can be done with simple machines?". The module title written as a problem question is presented in the document on the left, followed by the part "Why do I learn this?" (Zakaj se to učim?). The categories "Aims" (Učni cilji), "Learning outcomes" (Učni dosežki), "Prior knowledge" (Predznanje), "Literature" (Viri), and "New concepts" (Novi pojmi) are listed at the bottom. In the document on the right, "Student tasks" (Naloge za učence) are presented.

5. The experiences of Slovenian teachers acquired with the implementation of 3 PROFILES physics modules

Purpose and methodology

The PROFILES physics modules described in the previous section were evaluated. Based on the data and the feedback of the teachers collected, we wanted to assess the efficiency of the PROFILES approach to teaching. Our research questions were as follows: (1) Are there any significant differences in achievements on examination between the experimental and control group?; (2) How does the PROFILES approach of teaching work in practice?

Methods

The research was based on the quantitative and qualitative research approach. The descriptive and the causal-quasi-experimental research method were used.

Sample

The research included the students of 7th and 9th class (188 in total). The students were divided in a control (CG) and experimental group (EG). The topic “sound” was applied in 3 7th classes with 63 students in total (N (CG) = 22, N (EG) = 41). The topic “simple machines” was implemented with 69 students from 4 9th classes (N (CG) = 30, N (EG) = 39). The topic “Ohm’s law” was introduced in 6 9th classes comprising 125 students (N (CG) = 56, N (EG) = 69).

Data collection

The data was collected using a test of knowledge and teachers’ portfolios were used. The SPSS software was used to analyse the data (knowledge tests). The frequency distribution of the attributive variables, basic descriptive statistic for numerical variables, and t -test were used.

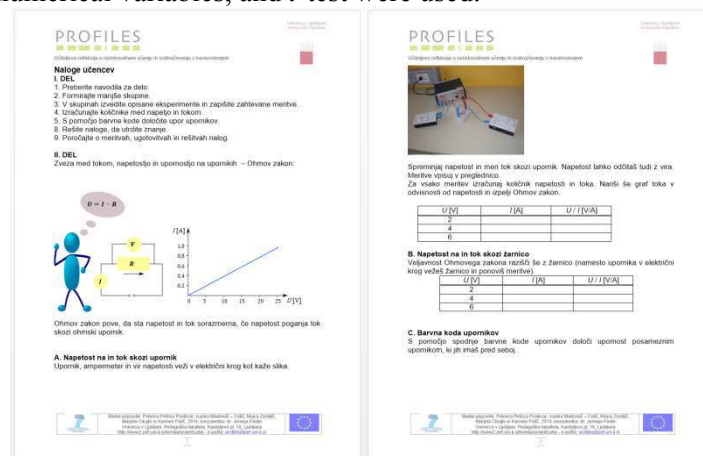

Figure 4. Part of the “Student tasks” for students of the PROFILES module “Resistance, current, and voltage: brothers from the same house?”. In part I (I. del), the students find a scenario. In part II (II. del), a theoretical background and experimental tasks related to A. voltage/current – a resistor, B. voltage/current – a bulb and C. resistors colour code are briefly described.

6. Results and discussion

The modules designed were evaluated. The information on student knowledge was gathered by knowledge tests. Teachers' observations and findings, students' feedbacks and their achievements in the knowledge tests were presented in teachers' portfolios. The summarized findings are presented in this section.

Student understanding of specific physics concepts introduced by the PROFILES modules

After the module concerning to each of the 3 topic groups (sound, simple machines, Ohm’s law) was applied in the experimental group, the differences in student achievements (the average number of points expressed as a percentage) in both the control and experimental group were not statistically significant (Table 2).

Table 2. Differences in the average number of achieved points in the test of knowledge between the experimental (EG) and (CG) control group

Topic		<i>M</i>	<i>SD</i>	<i>t</i>	<i>df</i>	<i>p</i>
Sound	CG	70	15	0.109	61	0.913
	EG	70	21			
Simple machines	CG	70	16	0.691	67	0.492
	EG	66	23			
Ohm's law	CG	68	25	0.498	123	0.619
	EG	66	28			

Physics teachers' experiences with PROFILES implementations

We also analysed portfolios prepared by the teachers. Some of the findings discovered in the analysis of teachers' portfolios are presented here. The teachers observed that the students had positive expectations before the start of working with PROFILES modules. The introductory part of the module in a form of a story presented a powerful motivational tool for the students, because this type of story from everyday life connects the physics content with the daily life of the students. Unfortunately, the teachers report that students' interest was only short-term. Each of the 3 PROFILES modules is planned for 4 school hours. Physics and science are on schedule 2 hours per week, thus students tended to forget a lot from one hour to the other. It turned out that the students were on average tired of working with modules and lost an overview on the content, whereas the work was fragmented. Some students also asked the teachers why they stopped explaining the content. This clearly shows that students are not familiar with the PROFILES approach and they missed the classical approach of teaching, where the teacher explains the topic and they make notes. The teachers suggested the use of PROFILES modules during a science day, where students can work with a single module without breaks. They also reported that it is sensible to provide a theoretical introduction of the new content before the work with the module. The teachers reported that despite the carefully designed teaching modules the nature of some contents is still too abstract for the low-ability students. Such students require teacher explanation on elementary level, which is, in turn, contrary to the IBSE approach.

The teachers report that learning in the course of PROFILES modules revealed comprehension difficulties with many students. Furthermore, the students encountered difficulties while solving tasks related to the reading of the data from tables and graphs and draw graphs, because they were not familiar with this type of data manipulation. Quite often, the students did not read the instructions for performing the experimental tasks carefully, which resulted in inappropriate measurements. The teachers have to encourage the students to grow familiar working with a text so that they are able to extract the key information as well as information necessary for their further work. In this way, the students develop the competency of finding key information in a text.

The teachers had high expectations related to the assimilated knowledge of their students. But the achievements of the students were not as high as they expected, because the questionnaires presented an unnecessary burden to a significant proportion of the students. The achievements of the students who participated in the PROFILES modules are comparable to the achievements of the students in the control groups, although, in both cases, only the lower learning domains were examined. Observing the students during the independent experimental work, the work efficiency with high ability learners was detected. The work with modules presented them with a challenge; they were effective and deepened their understanding. The teachers also report that the understanding of the content was lower with the low-ability PROFILES learners compared to the low-ability learners from the control group. The students worked with text and data. These types of activities were time-effective for high ability learners, whereas the low-ability learners were lost in the abundance of data. The activities planned were too time-consuming for them.

Teachers' observations about student achievements were also statistically confirmed (Table 2). However, little interest of students to cooperate in collecting data partly limits the conclusions. From the perspective of checking the implementation efficiency of the PROFILES approach, we need to reconsider how to ensure consistency and motivation for collecting data. Although the results do not show any statistically important differences between the experimental and control group, the teachers welcome the PROFILES (and therefore IBSE) approach, especially for gifted students. However, the results were also influenced by the duration of the PROFILES implementation. Because the innovation was implemented only by 2 PROFILES modules in each classroom, the impact of the PROFILES approach results on the achievements in the test of knowledge cannot be fully described. More PROFILES modules (one per day) should be implemented into classroom work so that the overall effect of the approach on knowledge could be assessed. While designing the PROFILES modules, the teachers used research data about students' understanding of certain physics concepts and misconceptions according to their own assessment, which limits the conclusions about the assimilated knowledge of students as well. It would be also interesting to measure the influence of student's interest and attitude to group learning on students' achievements in the tests of knowledge as well. All these findings show guidelines for future research that would enable a more comprehensive evaluation of the PROFILES modules impact on the motivation to learn science and the achievements in the tests of knowledge.

7. Conclusion

This paper briefly presents the PROFILES project. In the project, the PROFILES modules were developed by the Slovenian primary and secondary school teachers. The modules promote the IBSE approach. In Slovenia, a few science teachers developed physics modules. The PROFILES modules about sound, simple machines and Ohm's law and their evaluations were presented in the paper. The results showed comparable achievements in the knowledge test related to the PROFILES approach of teaching and the classical teaching approach. It was also shown that the PROFILES approach of teaching was well accepted among the teachers and gifted students. On the other hand, the teachers should present the importance of learning approaches that are emphasised by the PROFILES strategy to the students in a way that students would understand their enthusiasm over an innovative approach and make an effort to learn in a social context cooperatively. However, further research is necessary to properly understand the impact of the PROFILES approach on the motivation for learning science and as well as on the achievements in the tests of knowledge.

References

- Arlegui, J., Demo, B., Moro, M., and Pina, A. (2010). Discussing about IBSE, Constructivism and Robotics in (and out of the) Schools. In J. Clayson & I. Kalas (Eds.), *Proceedings of the Constructionism 2010 Conference*. Paris, France, Aug 10-14.
- Bolte, C., and Holbrook, J. (2012). An Introduction to PROFILES: Professional Reflection-Oriented Focus on Inquiry based Learning and Education through Science PROFILES. In Campanella L. (Ed.), (p. 53), *Stimulating reflection and catalysing change in chemical education: Book of Abstracts from ICCE/ECRICE 2011*. Rome: University of Rome.
- Bolte, C., Holbrook, J., and Rauch, F. (Eds.). (2012). *Inquiry-based Science Education in Europe: Reflections from the PROFILES Project*. Berlin: Freie Universität Berlin
- Devetak, I., Ferk Savec, V., Glažar S. A., Juriševič, M., Metljak, M., Pavlin, J., and Wissiak Grm, K. S. (2014). PROFILES modules in the Slovenian context. In Bolte, C. et al. (Eds.) *Science teachers' continuous professional development in Europe: case studies from the PROFILES projects*. Freie Universität Berlin, Germany, 113-119.
- Devetak, I., Ferk Savec, V., Glažar, S. A., Juriševič, M., Metljak, M., Kralj, B., Urbančič, M., Vogrinc, J., and Wissiak Grm, K. S. (2012). Slovenian reflection on the first year of the PROFILES project. In Bolte C. (Ed.), Holdbrook J. (Ed.) and Rauch, F. (Ed.), *Inquiry-based science education in Europe: reflections from the PROFILES project: book of invited presenters*. Berlin: Freie Universität Berlin, 145-147.
- Dominič-Radivojevič, T., Dragar, K., and Leben, M. (2013). Ali sem res cel orkester? In Juriševič, M. et al. (Ed.), (pp. 16) *Motiviranje nadarjenih učencev za učenje naravoslovja: zbornik povzetkov*. Ljubljana: Pedagoška fakulteta.
- Hanson, D. M. (2006). *Instructor's Guide to Process-Oriented Guided-Inquiry Learning*. Lisle, IL: Pacific Crest.
- Holbrook, J. (2012). Requirements of PROFILES Modules. *PROFILES Newsletter*, 3.
- Holbrook, J., and Rannikmae, M. (2012). Innovative Inquiry-based Science Learning Environments in the Framework of PROFILES. In Bolte C. (Ed.), Holdbrook J. (Ed.) and Rauch, F. (Ed.), *Inquiry-based science education in Europe: reflections from the PROFILES project: book of invited presenters*. Berlin: Freie Universität Berlin, 52-55.
- Juriševič, M., Devetak, I., and Vogrinc, J. (2012). Teacher's Portfolio in the PROFILES Context: Some Conceptual and Methodological Issues. In Campanella, L. (Ed.), (p. 494), *Stimulating reflection and catalysing change in chemical education: Book of Abstracts from ICCE/ECRICE 2011*. Rome: University of Rome.
- Metljak, M. (2014). Mreženje učiteljev pri projektu PROFILES v Sloveniji. In Devetak, I. (Ed.), Metljak, M. (Ed.), *Inovativno poučevanje naravoslovja in spodbujanje naravoslovne pismenosti v osnovni in srednji šoli*. Ljubljana: Pedagoška fakulteta, 57-68.
- Parsel (2009). Retrieved from: <http://www.parsel.uni-kiel.de/cms/index.php?id=home&L=0> (1.11.2014).
- Planinšič, G., et al. (2008). *Učni načrt. Fizika: gimnazija: splošna gimnazija*. Ljubljana: Ministrstvo za šolstvo in šport: Zavod RS za šolstvo.

Rauch, F., and Dulle, M. (2012). How to involve stakeholders in IBSE networking. In Bolte C. (Ed.), Holdbrook J. (Ed.) and Rauch, F. (Ed.), *Inquiry-based science education in Europe: reflections from the PROFILES project: book of invited presenters*. Berlin: Freie Universität Berlin, 59-67.

Skvarč, M., et al. (2011). *Učni načrt. Program osnovna šola. Naravoslovje*. Ljubljana: Ministrstvo za šolstvo in šport: Zavod RS za šolstvo.

Verovnik, I., et al. (2011). *Učni načrt. Program osnovna šola. Fizika*. Ljubljana: Ministrstvo za šolstvo in šport: Zavod RS za šolstvo.

Affiliation and address information

Jerneja Pavlin
University of Ljubljana
Faculty of Education
Department of Physics and Technical Studies
Kardeljeva ploščad 16
1000 Ljubljana, Slovenia
E-mail: jerneja.pavlin@pef.uni-lj.si

The Role of Mathematics for Physics Teaching and Understanding

Gesche Pospiech¹, BatSheva Eylon², Esther Bagno², Yaron Lehavi², Marie-Annette Geyer¹

¹*TU Dresden, Dresden, Germany;*

²*Weizman Institute, Rehovot, Israel*

Abstract

That mathematics is the "language of physics" implies that both areas are deeply interconnected, such that often no separation between "pure" mathematics and "pure" physics is possible. To clarify their interplay a technical and a structural role of mathematics can be distinguished. A thorough understanding of this twofold role in physics is also important for shaping physics education especially with respect to teaching the nature of physics. Herewith the teachers and their pedagogical content knowledge play an important role. Therefore we develop a model of PCK concerning the interplay of mathematics and physics in order to provide a theoretical frame for the views and teaching strategies of teachers. In an exploratory study four teachers from Germany and four teachers from Israel have been interviewed concerning their views and its transfer to teaching physics. Here we describe the results from Germany. Besides general views and knowledge held by all or nearly all teachers we also observe specific individual focus depending on the teachers' background and experiences. The results fit well into the derived model of PCK.

Keywords

Mathematics, pedagogical content knowledge, physics education

1. Introduction

The description of physical processes by mathematical means is one of the most characteristic traits and most powerful tools of physics research, and so it is undisputed that mathematics is the language of physics (see e.g. Dirac 1939, Wigner 1962, Bochner 1963, Hestenes&Sobczyk 1987). Both are closely interrelated and even more: often mathematical structures are inherent in physical concepts. Therefore the nature of physics as an empirical science where mathematics and physics are closely intertwined should be a central aspect of physics education. As its goal consists in teaching the principles, concepts and methods of physics, in short: the nature of physics the use of mathematical elements should be an intrinsic feature of teaching, adapted to the respective school level. However, understanding the meaning of different mathematical tools and their interrelation with the physical description of the world seems to be one of the most difficult steps in physics learning. In investigating this interrelation from an educational perspective, many questions arise. The overarching question is: Can the domain of mathematical structures improve the understanding of physical concepts and if so, in which way? How can the interplay of mathematics and physics be taught appropriately? In physics lessons teachers, their views and their competences, in short: their pedagogical content knowledge play a central role for the successful learning of students. Up to now only little is known about the knowledge and views of teachers in the important area of shaping the interplay of mathematics and physics. Therefore the central point of teaching physics should come into focus of physics education research.

2. Theoretical Framework

The study of physics at university incorporates mathematics as a prerequisite which often represents a difficulty for students in problem solving and applying mathematics appropriately to physics problems (e.g. Tuminaro&Redish 2007, Sherin 2001). One could ask oneself where these difficulties are rooted. Generally, e.g. in Germany the curricula and exams in high school regard the use of mathematics in physics as important and also as preparing for physics study at university (KMK, 2006). However, in junior high school (grades 6 to 10) physics is generally taught in a more qualitative approach (KMK, 2004). Only in few instances mathematics really is applied in a deeper way. Nevertheless as in these middle grades the first steps towards the later and more extensive use of mathematics are done, it is important to analyse which aspects of mathematics in physics are central and how they could be taught. The proper shaping of the interplay of mathematics and physics in physics education is important for giving the students an insight not only in

physics but also into the nature of physics, (Hestenes, 2013). On the whole we suppose no sharp distinction between the mathematical and physical models (Greca&Moreira 2002) but more a inseparable intertwining of both science areas.

Role of mathematics in physics and in physics education

The role of mathematics in physics covers different aspects: Pietrocola (2008) distinguishes a technical and a structural role. Since here not always a sharp border can be defined, we differentiate in addition the modelling aspect, where the results of physical experiments and observations are ordered with help of an abstract symbolic system, and the communicative aspect, using and setting into relation to each other different representations (Krey 2012). In general, mastering the purely technical role is not sufficient for being successful in physics (Bing&Redish 2009). Besides the technical aspects of mathematical syntax, the calculating and solving (differential) equations, the semantics, the physical meaning of mathematical structures, play an important role (Sherin 2001). The structural role implies that physics inherits the formal operations and definitions of mathematical objects, thus allowing for formal derivations of physical laws not thinkable of before. In addition mathematics might order the physical phenomena according to underlying patterns (modelling and hinting at analogies) and in a further extension it enriches physical thought by the physical meanings of mathematical operations (operations, limiting cases, functions,..).

In order to mirror these aspects in physics education not only the technical but above all the structural role must be taught intentionally. Students have to learn how to use mathematics for structured thinking about physical processes and how to interpret mathematical structures in physical terms. Different mathematical elements or representations such as geometrical objects, diagrams, algebraic expressions and verbal explanations have their specific roles for supporting understanding by describing exactly, quantifying and visualizing physical processes (Pospiech 2007). Their use requires mathematical abilities on very different levels: it starts with recognizing and verbalizing functional dependencies /e.g. the more .. the more) and then goes to the quantitative description with diagrams or algebraic expressions including interpreting diagrams and formula in terms of physical concepts. The next more complex step consists of applying techniques of modelling and idealization. A final, quite advanced step would be the mathematical formulation of basic physical principles in the framework of theories which is for the most part beyond school physics (e.g. Noether theorems).

Especially for students in junior high school the first steps towards the mathematical description of physics are crucial (Pospiech, 2007). The path from a phenomenological level up to a more abstract level where mathematical reasoning concerning physical laws and processes can take place has to be shaped carefully treating both the technical and the structural aspect. In order to grasp possible patterns in this process of mathematisation a model has been developed focussing on the structural aspect and leaving open the possibility of very different strategies and patterns for deriving mathematical descriptions, depending on the mathematical tools available (Uhden et al 2012). This model can serve for classifying difficulties of students in solving problems, (Uhden 2012). In addition it can serve as an analytic tool for the teaching process in that it shows which mathematisation steps are necessary and indicates how difficult they might be (Müller 2012). Therefore it gives hints for students' ideas as well as for instructional strategies.

Role of Pedagogical Content Knowledge of teachers

Teachers and their professional knowledge play a central role for the learning of students. (Krauss et al 2008, Riese 2010, Shulman 1986). Shulman (1986) identified the so called pedagogical content knowledge (PCK) as „amalgam of content knowledge and teaching abilities“. Some studies (e.g. COACTIV) show a positive effect of good PCK for learning of students and cognitive activation (Kunter et al 2011). There are different models of PCK (Gramzow et al 2013). However, most models agree that e.g. knowledge of explanations and representations and knowledge of students thinking are important. We are using the model of Magnusson et al (1999). It unfolds the PCK in five dimensions which are interconnected: Orientations Toward Teaching, Knowledge of Science Curriculum, Knowledge of Students' Understanding of Science, Knowledge of Assessment in Science and Knowledge of Instructional Strategies.

By analogy the consistent teaching of the complex interplay of mathematics and physics requires that the teachers are aware of basic metacognitive ideas concerning the general, structural role of mathematics in physics and use them to shape the interplay regarding the students ideas and abilities on the different educational levels. For this purpose the teachers should develop an appropriate PCK adapted to the role of mathematics in physics education.

3. Research Questions

In general the topic of the role of mathematics in physics education and the knowledge, the teaching strategies and views of teachers about it are quite unresearched until now. Taking into account the central role of mathematics, especially its structural aspects, this research gap is astonishing. In order to get insight about this aspect an exploratory study with experienced or expert teachers (which might be distinguished) seems to be an appropriate way to get an idea of what is possible and how a PCK about „role of mathematics in physics and in physics education“ could look like. In this first preliminary study also the occurrence of possible strategies in teaching should be explored. The questions treated in this contribution are:

- What do experienced teachers think about the role of mathematics in physics?
- Which strategies do they use to convey the structural role of mathematics in physics?

4. Methods and Study

In order to answer the research questions in a first step we derive a specific model for the PCK of teachers concerning the interplay of mathematics and physics. This model contains the aspects described above. From this an interview guideline was developed for exploring the views of teachers in a first study with four teachers from Germany. The interviews with teachers of different background should also help to test the PCK-model and identify different characteristics of it among the teachers.

Proposal for PCK of teachers with respect to mathematics in physics education

In developing the PCK-model we are drawing on the distinction of technical and structural role of mathematics for physics as described above. In order to unfold the components of PCK we remark that mathematics provides tools representing and quantifying physical processes and quantities. Its structures have to be interpreted physically and can help in recognizing analogies. The intertwining becomes obvious in physical concepts which cannot even be formulated without mathematics, as e.g. the velocity or acceleration. We expect teachers to be aware of all these theoretical considerations. In addition their professional knowledge should include the implications for enacting formal procedures and algorithms in class, e.g. by fostering the interpretation of symbols, the meaning of functional dependencies and so on. In this field of the interplay between physics and mathematics the teachers should be able to move consciously and well reflected on their own views, their students' views and the objectively given interrelations. Basis for all this is the general orientation towards teaching and their explicit and implicit goals of physics teaching.

In the following we describe the different components of the PCK in accordance to the Magnusson model (1999) and give a detailed description with respect to our topic:

11. Orientations Toward Teaching Physics

General aspects: The teachers should reflect on the impact of the broad philosophical or historical discussion about the role of mathematics in physics on their own views and teaching.

Metacognitive ideas about the interplay of mathematics and physics: The teachers should consider in which way the mathematisation can contribute to insight of their students into the nature of physics and into the physical method. They consider the role of deductive reasoning in physics teaching with help of mathematical techniques. They reflect on the relation of experiment and use of mathematics in their teaching.

(f) Knowledge of Physics Curriculum with Respect to Use of Mathematics

Knowledge of Goals and Objectives: Teachers can reflect on goals of the use of mathematics as expressed in the official curriculum and set these considerations into relation to their own views. They relate the curricula across the grades and are aware of the interplay of physics and mathematics curricula.

Knowledge of Specific Curricular Program: Teachers should know concrete examples where they can apply mathematics in different degrees of complexity. They are aware of specific chances or difficulties, inherent in the curriculum.

(d) Knowledge of Students' Ideas

Knowledge of Conditions of Learning: Teachers know which mathematical and physical knowledge the students have to integrate. They are aware of general learning obstacles. Optimally they also know about the concrete mathematics prerequisites the students bring into their class.

Knowledge of specific aspects: Teachers can differentiate between purely technical and more structural problems of the students. (a) Mathematics as a problem: Teachers know the most difficult points in the use of mathematics in physics, seen from the students' perspective. (b) Mathematics as a useful help: Teachers

know at which point the use of mathematics can support the students or motivate them towards the use of mathematics in physics.

- Knowledge of Instructional Strategies concerning the technical role of mathematics

Mathematics as a tool for communication (representation): Teachers know which mathematical representations they can use in teaching physics and how to integrate diagrams, algebraic and verbal representation appropriately.

Mathematics as a formal tool: Teachers are aware of critical points w.r.t the technical role of mathematization. They know which kind of instruction, activities and exercises can be used and where to set their emphasis in order to ensure mastering technical aspects.

- Knowledge of Instructional Strategies concerning the structural role of mathematics

Mathematics as supporting physics understanding: Teachers know how to increase physics understanding by using appropriate mathematisation on the structural side. They foster basic understanding by structuring physics.

Knowledge of strategies shaping the interplay: Teachers know with which examples and methods they can give the students insight into the nature of physics and the physical method. (a) Teachers use derivations and deductions in order to clarify relations and concepts. (b) Teachers use experiments and relate them to mathematical descriptions of physical laws.

Design of Interviews and Sample

The interviews covered the components of the PCK described above. The focus was the view of the teachers about the role of mathematics for physics teaching, the relevance for students learning and students' difficulties as well as examples of instructional strategies. The interviews were semi-structured and were conducted according to a guideline. The questions were very broad in order to explore the field. They were given to the teachers about one week in advance so that the teachers had the opportunity of preparing and making their view clear.

In Germany four teachers have been interviewed, two male and two female. All have studied mathematics as second subject in the same depth as physics and have more than 20 years of teaching experience. They are allowed to teach mathematics and physics on all levels from grade 5 to grade 12, the final grade before school-leaving exam. One teacher (T1) "Master Teacher") was involved in developing the current physics curriculum; one teacher (T2) is the head teacher for mathematics and physics in his school, implying above average qualification. One teacher (T3) has a focus on mathematics teaching, including advanced high school courses, nevertheless regularly teaching physics classes, mainly in junior high school up to grade 10. One teacher (T4) has a strong focus on teaching physics for younger students in the grades 6 to 10, but is also teaching mathematics.

Teacher T1 had a very broad preparation with refined arguments, teacher T2 did not prepare; the others were in between. The interviewer knew all of the teachers personally so that the atmosphere of the interviews were open and with confidence. The teachers volunteered for the interview because they are strongly convinced that mathematics is necessary for physics teaching, even in junior high school starting from grade 6. Two of the interviews were done by telephone. All lasted between 45 minutes to 60 minutes. The interviews have been audio-taped and transcribed.

Method of data evaluation

Starting from the PCK-model categories were defined deductively. In the second step these categories were refined inductively from the material. The categories were validated in collegial discourse. Then the interviews were coded and discussed within the research group.

5. Results of interviews with teachers in Germany

Characterization of teachers

As the teachers agreed voluntarily to the interviews it was to be expected that they all gave the interplay of mathematics and physics in physics lessons a big relevance. However, the teachers showed individual key aspects in their views and own characteristics in their PCK as is seen in the distribution of the percentages of their statements in the different categories corresponding largely to the components of the PCK (see Fig 1).

Figure 1. The percentages of the respective statements of the teachers are given. It is seen that there are clear differences between the teachers, especially concerning the students ideas and the awareness of the structural role of mathematics in teaching.

With respect to the first research question, which refers to the component *Orientation towards Teaching Physics* with the subcategories *General aspects* and *Metacognitive ideas about the interplay of mathematics and physics* it was said: “that it is very important this relationship between mathematics and physics because in certain points profound insights in physics can only be reached with mathematics.”(T2) or „Without mathematics, physics is not possible“. or that the “mathematical methods are an important contribution to develop an understanding of the relationship between empiricism, i.e. experiment and theory.”(T1). For teacher T1 it is important that the mathematics always has a physical meaning and has to be interpreted: „Moreover, the mathematical method is basis for the acquisition of knowledge in physics lessons. From a basic view the strongly mathematics oriented teacher T3 stresses that “The exactitude there is already important.”

On the whole the teachers had a quite homogeneous view on the interplay, but nevertheless they showed in their style different specifications in detail. Two teachers (T2 and T4) showed a strong concern that experiments are important for understanding and motivation and that the use of mathematics might not destroy this benefit. Teacher T3 had a very strong emphasis on the mathematical side with mainly technical concerns. Teacher T1 discussed at length the overall importance of mathematics along the physics curriculum.

Generally all the teachers have high knowledge of the curriculum, (component “*Knowledge of Physics Curriculum with Respect to Use of Mathematics*”, see fig. 1). They can give concrete examples where the interplay of mathematics and physics plays a role, where it is demanded that they do it and where they do it voluntarily because they think it important or helpful. Often they even know precisely the curriculum of mathematics, partly because they are teaching this as well. It can be seen that the knowledge is especially precise, but not restricted to, on the topics or classes they teach more often or regularly. As a special point all the teachers state that the amount of formulas in physics curricula, hence the use of mathematics in physics teaching, has been largely reduced in the last ten years, especially in junior high school.

Stressing the structural role of mathematics

As there are rich data and many information the teachers gave we cannot present all in this contribution. For answering the second research question we will focus on the teaching strategies and the combination of technical and structural role referring to the subcategory *Knowledge of strategies shaping the interplay* of the component “*Instructional strategies*”. Here the number of statements differ very strongly between the teachers (see fig 1). As some teachers value the experiments very highly this is an own aspect to be analysed. We observe different strategies of the teachers in order to use mathematical elements for supporting understanding. One is in the use of multiple representation, the other in changing back and forth (“interlacing”) between the different roles of mathematics or between experiment and mathematical description.

Invoking different representations for stressing the structural role of mathematics in physics

We analyse descriptions of how the teachers employ different representations, mostly equations and diagrams where the diagrams often serve as a means for evaluating experiments and how they come e.g.

from experiment to formula. This starts right with the beginning physics lessons as expressed by teacher T4: „*So in class 6 it starts, that drawing diagrams is transferred from the mathematics and then more and more practised.*“ with awareness of the complications: „*I, for example, already experienced that for the class 6 it is still a problem to draw a line graph.*“ (also see Mevarech&Kramarsky 1997). This is mostly combined with practical aspects: „*I'll introduce it [density] quite visual, by making them something to measure.*“ Even more pronounced is the visual aspect (also w.r.t. density) in the typical strategy of teacher T3 combining experiment and explicit calculation which uses all types of representations in a logical sequence: „*Then we have determined the mass of water for different volumes with an experiment. They have entered the values into a table and then they should draw the graph and just observe, where the proportionality could be. Then we have calculated the proportionality constant. We have also shown that there is quotient equality, so that we can call it proportionality.*“ or in the explicit connection of diagram and proportionality: „*Consider: I have to double the heat for the same temperature change; so the diagram should look like that.*“. Teacher T2 wants to show the importance of mathematics for practical aspects in the possibility to quantify physical quantities: „*Which wire do I have to buy if I want to build a suitable circuit? What diameter of the wire is necessary?*“ or „*Now you can see on the basis of this equation what needs to be changed in this resonant circuit.*“ A more abstract explicitly metacognitive stance is taken by teacher T1: „*Mathematics is the basis for the evaluation of experiments, ie by collecting measured values in tables, estimating the uncertainty of measurement by calculation, etc.*“. He stresses that mathematics can lead to new insights with help of diagrams and equations: „*Once I work with equations and diagrams in order to develop concepts and laws*“ and in high school he uses even more complex tools: „*So I can formulate new equations or new contexts about these diagrams by understanding slope and area under the curve.*“

All these statements show that for some teachers the practical aspect is in the foreground whereas other teachers also consciously try to convey the theoretical influence of mathematics by the possibility of deduction, often in combination with experiments. In both cases they use different representations and set them into relation to each other.

Shaping the interplay mathematics - physics by interlacing structural and technical aspects

Here we analyse strategies, sometimes also involving experiments. Sometimes a linear path from concrete to abstract can be observed, sometimes the way back is stressed.

For teacher T3 the whole path from the practical or experimental to the formula is very important: „*that [a student] describes the practical situation, can explain and that he can justify it mathematically in many places.*“. She explicitly refutes the purely technical procedure if students only mechanically try to solve problems: „*to take out a formulary, without thinking*“ but the students should instead experience mathematics as supporting physics understanding „*They have really an understanding of why we do it this way.*“ and they should be able to explicitly combine the physical and the mathematical aspects: „*Density: grams per cm³. Interpret this. Explain with the particle model.*“ or „*What is the impact of the constant factor?*“, requiring a clear connection between mathematical equations and physical concepts.

Teacher T4 sees that the mathematical form is not always absolutely necessary but that there are levels in between: „*This the more – the more - statements / you can do a lot with these statements. Actually you do not need the formula for it.*“, an intermediate semi-quantitative representation, so to say a "formula in words" between purely qualitative and purely formal and quantitative statements. This seems to be quite appropriate for her mostly younger students.

For teacher T1 mostly teaching higher grades the connection of calculations to applications is central: „*In the first instance we work with equations and diagrams to calculate physical quantities in the context of physical tasks.*“ and insists that the students have to learn that it is important to interpret any numerical result: „*But in the classroom, every lesson, if we calculate anything, I want to know: Is that a lot? Is that enough? Can it be? What does this tell us?*“. This is the surface of the underlying structural role of mathematics in physics: „*Applying the mathematics so that the physical models really can be calculated.*“ and „*But I also think that these mathematical short forms are .. ultimately a means for recognizing analogous structures.*“ In a similar way teacher T2 is reasoning: „*I still put a lot of emphasis on the interpretation of equations.*“, but also with reference to practical applications or to deductive results: „*If you have an equation, then you can derive many things from the equation and then always imagine, what lies behind it practically.*“. Furthermore he very clearly addresses that this should be done in order to evade that „*The equations are always like a black box for the students.*“ and that there are examples where only mathematics can answer physical questions:

„The theory of relativity is indeed the place where you can clearly show the students that only with mathematics it was possible to get predictions regarding the time dilation, length contraction, everything else.“

So the main strategies again mirror the different experiences of the teachers. All insist that mathematical results have to be interpreted in physical terms and concepts or with respect to applications. Therefore the use of algebraic representation always is back and forth connected to experiments or to evaluation in terms of verbal representations. Teacher T2 stresses that there are areas of physics that can be treated fully only by mathematics (special relativity).

Setting individual emphasis throughout the curriculum

Each teacher has, depending on the grades and contents he or she is teaching mostly, developed his or her own specific main focus he lies emphasis on. It could be the practical side of mathematics, the specific difficulties of beginners or the working with models. This analysis will be given in a different paper.

6. Conclusions and Perspectives

In a model of PCK for teachers we elaborated on aspects relevant for teaching the interplay of mathematics and physics at school. The interviewed physics teachers were aware of its basics. They mostly took a practical stance, strongly influenced by the curriculum and dominated by realizing their strategies and taking into account typical problems and strategies of students, both from a technical and from a structural aspect. Based on these findings it would be interesting to look at actual lessons and to confirm the actual classroom practices of teachers and students with the goal of identifying successful patterns of teaching strategies. The focus should lie on junior high school because the basis is created here.

References

- Bing, T., & Redish, E. (2009). Analyzing problem solving using math in physics: Epistemological framing via warrants. *Physical Review Special Topics - Physics Education Research*, 5(2), 020108.
- Bochner, S. (1963). The Significance of Some Basic Mathematical Conceptions for Physics. *Isis*, 179–205.
- Dirac, P. A. (1939). The relation between mathematics and physics. In *Proc. Roy. Soc. Edinburgh* (Bd. 59, S. 122).
- Gramzow, Y., Riese, J., & Reinhold, P. (2013). Modellierung fachdidaktischen Wissens angehender Physiklehrkräfte- Modelling Prospective Teachers' knowledge of Physics Education. *ZfDN (Zeitschrift für Didaktik der Naturwissenschaften)*, 19, 7–30.
- Greca, I. M., & Moreira, M. A. (2002). Mental, physical, and mathematical models in the teaching and learning of physics. *Science Education*, 86(1), 106–121.
- Hestenes, D. (2013). Remodeling science education. *European Journal of Science and Mathematics Education*, 1(1), 13–22.
- Hestenes, D., & Sobczyk, G. (1987). *Clifford Algebra to Geometric Calculus: A unified language for mathematics and physics* (Bd. 5). Heidelberg: Springer.
- KMK – Kultusministerkonferenz. (2004). *Bildungsstandards im Fach Physik für den Mittleren Schulabschluss*. http://www.kmk.org/fileadmin/pdf/PresseUndAktuelles/Beschluesse_Veroeffentlichungen/allg_Schulwesen/Physik_MSA16-12-04.pdf
- KMK – Kultusministerkonferenz, B. (2006). *Einheitliche Prüfungsanforderungen in der Abiturprüfung*. Neuwied: Wolters Kluwer. <http://www.kmk.org/dokumentation/veroeffentlichungen-beschluesse/bildungschule/allgemeine-bildung.html>
- Krauss, S., Baumert, J., & Blum, W. (2008). Secondary mathematics teachers' pedagogical content knowledge and content knowledge: validation of the COACTIV constructs. *ZDM*, 40(5), 873–892.
- Krey, O. (2012). *Zur Rolle der Mathematik in der Physik: wissenschaftstheoretische Aspekte und Vorstellungen Physiklernender*. Berlin: Logos.
- Kunter, M., Baumert, J., & Blum, W. (2011). *Professionelle Kompetenz von Lehrkräften: Ergebnisse des Forschungsprogramms COACTIV*. Münster: Waxmann.

- Magnusson, S., Krajcik, J., & Borko, H. (1999). Nature, sources, and development of pedagogical content knowledge for science teaching. In *Examining pedagogical content knowledge* (S. 95–132). Heidelberg: Springer.
- Mevarech, Z. R., & Kramarsky, B. (1997). From verbal descriptions to graphic representations: stability and change in students' alternative conceptions. *Educational Studies in Mathematics*, 32(3), 229–263.
- Müller, Torsten. (2012). *Mathematisierung im Physikunterricht* (Master Thesis). Dresden: TU Dresden.
- Pietrocola, M. (2008). Mathematics as structural language of physical thought. In M. Vicentini & Sassi, Elena (Hrsg.), *Connecting Research in Physics Education with Teacher Education volume 2, ICPE – book* (Vol. 2).
- Pospiech, G. (2007). On understanding, explaining and mathematical formulation of physical problems in secondary school. In *GIREP-EPEC Conference Frontiers of Physics Education-Selected Contributions. Rijeka*.
- Riese, J. (2010). Empirische Erkenntnisse zur Wirksamkeit der universitären Lehrerbildung - Indizien für notwendige Veränderungen der fachlichen Ausbildung von Physiklehrkräften. *PhyDid A-Physik und Didakt. Schule und Hochschule*, 9(1), 25–33.
- Sherin, B. L. (2001). How Students Understand Physics Equations. *Cognition and Instruction*, 19(4), 479–541.
- Shulman, L. S. (1986). Those Who Understand: Knowledge Growth in Teaching. *Educational Researcher*, 15(2), 4–14.
- Tuminaro, J., & Redish, E. (2007). Elements of a cognitive model of physics problem solving: Epistemic games. *Physical Review Special Topics - Physics Education Research*, 3(2), 020101.
- Uhden, O. (2012). *Mathematisches Denken im Physikunterricht Theorieentwicklung und Problemanalyse*. Berlin: Logos.
- Uhden, O., Karam, R., Pietrocola, M., & Pospiech, G. (2012). Modelling mathematical reasoning in physics education. *Science & Education*, 21(4), 485–506.
- Wigner, E. (1960). The unreasonable effectiveness of mathematics in the natural sciences. *Commun. pure Appl. Math.*, 13(1), 1–14.

Affiliation and address information for corresponding author:

Gesche Pospiech

TUD, Chair of didactics of physics, Department of Sciences, Technische Universität Dresden

Haeckelstraße 3

01069 Dresden, Germany

e-mail: gesche.pospiech@tu-dresden.de

Science Teachers' Transformations when Implementing Inquiry-Based Teaching-Learning Sequences.

Alessandro Zappia, Silvia Galano, Luigi Smaldone, Italo Testa

Department of Physics, University Federico II, Naples

Abstract

In this research study we aimed at investigating the mostly transformed/accepted aspects of scientific inquiry while enacted in classroom practice. Seven in-service biology, chemistry, and physics teachers, with more than 20 years of experience, were initially involved in a 30-hours training course aimed at familiarizing them with inquiry principles. The activities were organized in nine 3-hours workshops using seven teaching learning-sequences (TLSs) as training contexts. After the course, the teachers chose one TLS and were observed during the in-school delivery. Collected data have been video recordings and field notes of the classrooms activities. An adapted version of the Reformed Teaching Observation Protocol (RTOP) was used to analyze the data. Quality of inquiry implementations, as measured by the RTOP scores, led us to identify the aspects that were mostly accepted and/or transformed by the teachers. Results show that the most accepted aspects of inquiry were: - students act as members of a learning community; - there is focus on data collection and on students' argumentations according to a research question. Moreover, the teachers were keen to act as resource persons and valued classroom discussions. The most observed transforming trends were: - introduction of the concepts related to the TLS before doing laboratory activities; scarce attention to students' generation of the research questions; - forcing class discussions to get the "right" answer from the students; - scarce importance given to group work.

Keywords

Inquiry, Teacher Education, Video Study

1. Introduction and aims

Nowadays, the overall aims of science teaching are gradually shifting from the understanding of science 'facts' (what we know) to the understanding of science as an interpretative body of knowledge (how we know). Science classroom practice should hence go beyond the classical "content" boundaries of the individual disciplines (e.g., biology, chemistry, physics), stressing transversal methodologies to let students be reflective about their own procedures while doing science. A teaching approach that fulfils these aims is Scientific Inquiry (SI).

SI is a pedagogical approach that is increasingly acknowledged as central in many curriculum reforms documents since mid-nineties (NRC, 1996). Inquiry approaches allow students to experience science in a way that is grounded in real contexts (Jenkins & Nelson, 2005). Moreover, the methods of inquiry enacted by students should resemble the way in which professional scientists and researchers carry out their work (Blanchard, Southerland & Granger, 2009). The focus of such a teaching approach is also on students' argumentation to support their findings and on the reflection about the procedures adopted to solve a specific problem.

Notwithstanding such advantages, in countries as Italy, where the science curriculum is mainly content-oriented, implementation of inquiry approaches is still very limited (Bigozzi et al., 2014). Such evidence may be justified with the lack of appropriate training (Barrow, 2006; Ortlieb & Lu, 2011). Research studies have also highlighted the need for a collaborative and supportive community, where the teachers are given the opportunity to reflect on their practice and on how it might be improved (Anderson, 2002; Crawford, 2007). Finally, curriculum implementation literature has shown that when implementing innovative teaching-learning approaches, even trained teachers can "transform" the original designers' objectives (Van Den Akker, 1998) due to their attitudes, beliefs and expected outcomes (Jones & Carter, 2007). With the term "transformation" we refer to those features of a didactic innovation which are selected and reorganized by the teachers when they implement the innovation in their practice (Pintò et al., 2003). While some transforming trends may lead to fruitful modifications/enrichments, others may impact in a negative way, so that the original approach may be overall tuned down. Such transformations may concern the whole

approach of the innovation, as well the use of specific teaching strategies, technologies; and languages (Sassi, Monroy & Testa, 2005). Inquiry-based approaches are particularly prone to transformations since teachers may: - find significant challenges in implementing them in practice (Luft & Pizzini, 1998; Supovitz & Tuener, 2000); - hold beliefs that are contradictory with respect to inquiry pedagogy (Windschitl, 2003); - have never experienced themselves teaching or learning science with this approach (Kleine et al, 2002). Previous studies have mostly investigated the impact of professional development programs that could provide support for teachers about inquiry-based approaches (e.g., Nam, Seung & Go, 2013). On the contrary, more attention is needed to investigate which aspects of inquiry are mostly adopted or transformed by teachers in their school practice.

The research questions that guided the study are:

- RQ1: Which are the aspects of inquiry that teachers mostly accept?
- RQ2: Which are the aspects of inquiry that teachers mostly transform?

2. Methods

Training workshops

Prior to classroom observations and data collection, we organized a training course for the teachers who accepted to participate in the study. Activities were structured in three phases:

- involvement of the teachers in ten in-presence workshops about inquiry (30 hours);
- implementation on behalf of the teachers of one inquiry-based teaching-learning sequence (TLS) in their classroom (on average, about 4 hours);
- debriefing session on classroom activities (about one hour).

During the training workshops, teachers were introduced to SI through an “experiential” approach (Stofflet & Stoddart, 1994). According to this approach, teachers, while interacting with their peers, were engaged in the same activities of their students, in order to recognize more easily possible difficulties they could encounter when doing such activities. In this phase, existing research-based TLSs (SHU, 2009), were presented to teachers (see Table 1 for details). The analysis of existing scientific articles or papers about the nature of science was also carried out, with particular attention to: - the difference among hypothesis, research questions and prediction; - the interpretation of graphs and data tables; - discussion about benefits and problems rising from adopting such an approach of doing science in school practice. At the end of each workshop, the teachers were asked to produce a document with their impressions and considerations about the TLSs (portfolio). After the training workshops, teachers implemented one TLS among those proposed in their classroom; in doing this, enough freedom was given them to adapt the proposed activities of the TLSs to their needs and specific school context. After each implementation, teachers were interviewed for one hour on the activities carried out with students: feedback was provided through the analysis of the portfolios, field notes and videos (see below) recorded during the class session to emphasize emerging critical issues.

Table 1. Description of the teaching-learning sequences used in the study

Title	Context	What students do
Plants in Space	Students, as researchers of a department of bio-astronomy, have to develop suitable plans for a life sustaining unit for use on possible future space flights.	Investigations about the dependence of photosynthesis on radiation wavelength
Mars-ology	Students, as researchers at the Institute of Planetary Research, are asked by the NASA to propose a research study to be carried out with a space probe on Mars	Investigations about the role of lava viscosity on the shape of a volcano;
Out of site, out of mind	Students, as members of a city committee, have to study the risks of pollution due to landfills	Investigations about diffusion of polluting agents in the soil
Green Light	Students, as consultants of Energy Efficient Lighting Committee, have to produce a document on main	Investigations about the energy dissipation of a fluorescent and an

	advantages of using compact fluorescent lamps	ordinary filament lamp
Green Heating	Students, as researchers of an advertising company, have to produce a document about advantages of solar thermal collectors for domestic use	Investigations about the role of materials in energy transfers between radiation and matter
ET Phone Earth	Students, as TV journalists, have to prepare a television broadcast in which the possibility of extraterrestrial life will be discussed	Argument about evidence in favor and against the existence of extraterrestrial life
Collision Course	Students, as scientists of the “Stellar Center”, have to produce a written report for NASA about possible risks for Earth due to collisions with asteroids	Investigations about the momentum and energy of objects in hits

Sample

Ten volunteer secondary school science teachers (five females, two males) participated in the training workshops. The teachers had a long teaching experience (on average 24 years), and they were never involved in a training course about inquiry-based approaches. Three teachers (identified from now on as T1, T2, and T7) teach in a scientific lyceum, four (T3, T4, T5 and T6) in a vocational school. Four of them (T2, T4, T5 and T7), graduated in biology, teach Natural and Earth Science; one (T6) is graduated and teach chemistry; two (T1, with a mathematics degree, and T3, with an engineering degree) teach physics. They accepted to implement one TLS discussed during the workshops and were suggested to not use textbooks to avoid possible inconsistencies with what proposed in the TLSs. Due to external duties and constraints, only seven of them participated to all the ten training workshops. Hence, we decided to observe only these teachers in their classrooms.

Framework for analyzing implementation of the TLSs in classroom

The in-classroom deliveries of the TLSs carried out by the teachers were analyzed using a modified ARI (Adaptation and Re-Invention) Model (Rogers, 1983) originally introduced to describe brand and industrial exchanges between different national contexts. The main reason for adapting the TLSs was related to the need of aligning the didactic objectives of the TLSs with those of Italian secondary school science curricula. The analysis cycle is represented in Figure 1.

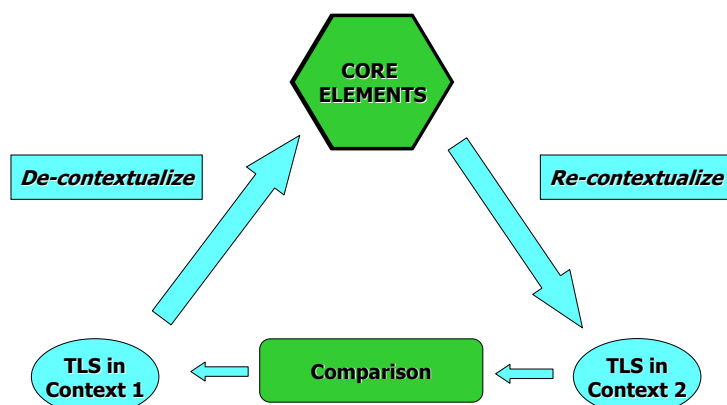

Figure 1. The model used to analyze classroom implementation of the proposed TLSs

First, we identified “core” and “not core” elements of the TLSs. As generally defined by the model, “core” elements are those features which characterize in an unique way the TLS. For this specific study, “core” elements concern the nature of scientific inquiry, and can be formulated as actions that students should carry out during the activities (see below). Examples are: - to use scientific ideas and models to explain phenomena; - to generate research questions; - to make predictions, estimations and/or hypothesis about the observed phenomenology; - to justify the proposed experimental/simulation procedures; - to draw

meaningful conclusions from collected evidence. Then, the teachers re-contextualized the core elements in their practice, taking into account “not core elements”, which are equally important, but do not necessarily characterize the TLS since they are mainly related to classroom management and activities timing. Ideally, core elements should not be changed while adapting the TLS for the classroom implementations, whereas not core elements can be changed to better fit the TLS in the school practice. Finally, the classroom delivery of the TLS was compared with the original TLS to identify the aspects that have been adopted and those that have been transformed.

3. Collected data and instrument

During the in-classroom delivery of the TLS (about 4 hours), two external observers took field notes and video-recorded the activities. Overall, about twenty hours of video were collected, three hours for each teacher. The three hours were chosen so that most of the TLS activities could be observed.

Analysis was carried out by means of an adapted version of the existing Reformed Teaching Observation Protocol, (RTOP; Sawada et al., 2002). The RTOP was chosen since it is a well known instrument to study impact of innovations and professional development programs, whose efficacy was validated by previous researches (Blanchard et al., 2010). Due to the specific focus of our study, we adapted some of the RTOP items according to the ARI model so that the items could be grouped into two main subscales corresponding to the “core” and “not core” aspects of the TLSs, respectively (Table 2).

Overall, nineteen RTOP items i_{1K19} were chosen and re-formulated so to emphasize the extent to which the teachers implemented specific inquiry aspects of the TLSs (core items) and whether they organized the classroom context as a place where students could actively participate to the activities (not core items). The score to each RTOP item, given on a Likert scale from 0 (not occurred) to 6 (perfectly descriptive), hence, provided evidence about what have been the aspects that were mostly accepted or transformed by her/him.

After the implementations, the RTOP raw scores of the two observers were compared with field notes to ensure validity of the scoring system. A final negotiation between the raters led to a consensual agreement with an inter-rater reliability score of 0.85. To gain more useful insights about the teachers’ practice, we calculated from the raw scores two additional variables: 1) for each item i_j , the average score (\bar{x}_{i_j}) of all teachers; 2) for each teacher t_i , the average score $(\bar{y}_{c_{t_i}})$ and $(\bar{y}_{nc_{t_i}})$ of the items corresponding to the “core” and the “not core” subscales, respectively.

Then, drawing on the previous uses of RTOP (Blanchard et al., 2010), the (\bar{x}_{i_j}) variable was re-coded into a three-level variable with the aim of giving a rough idea of the quality of the adoption of the specific inquiry aspect associated to the item (low, medium, high, see Table 3 for details). In the same way, $(\bar{y}_{c_{t_i}})$ and $(\bar{y}_{nc_{t_i}})$ variables were re-coded using a three-level variable with the aim of giving a qualitative idea of the level of transformation enacted by teachers (heavy, some and almost no transformation, see Table 4 for details).

Results

Table 2 reports the average raw scores obtained by the seven teachers for all the RTOP items used in this study.

Figure 2 shows the distribution of the “core” and the “not core” RTOP items according to the three levels categorization (low, medium, high) of adoption of inquiry aspects.

Table 2. RTOP items used to analyze teachers’ delivery of the inquiry-base TLSs v. Average teachers’ scores obtained in the present study are also reported.

Modified RTOP Items	Group	Average score (+-st. dev)
1. The teacher introduced the context of the proposed activities	Core	2,3 ± 0,9
2. Studying focused on the required topic	Not core	4,3 ± 1,9

3.	The teacher gave students enough time to discuss about the context	Not core	4,0 ± 2,2
4.	The teacher informed activities on the basis of what was provided in the brief	Not core	3,6 ± 1,9
5.	The teacher involved students in active communication of their ideas to others using a variety of means and media	Core	2,1 ± 0,9
6.	The teacher was able to manage students' questions and comments, varying the focus of activities according to students' suggestions	Not core	3,7 ± 2,5
7.	The final work is consistent with what was required in the brief	Not core	4,7 ± 1,8
8.	The teacher stressed the importance of classroom discussion and of listening what others had to say	Not core	5,1 ± 1,1
9.	The teacher acted as a resource person, working to support and enhance student investigations	Not core	4,6 ± 2,0
10.	The activities were enacted so to engage students as members of a learning community	Core	4,1 ± 1,5
11.	The teacher helped students to generate their own investigations	Core	3,1 ± 1,9
12.	The teacher allowed students to develop their own investigations	Core	4,0 ± 1,9
13.	The teacher focused on data collection	Core	5,0 ± 1,1
14.	The teacher let students analyze data by themselves.	Core	2,4 ± 1,4
15.	Teacher focused on students' final argumentations according to the research question.	Core	4,1 ± 2,3
16.	Students were asked to make predictions, estimations and/or hypotheses about the observed phenomenology and simulations, and to justify the proposed experimental or simulation procedures	Core	3,0 ± 2,1
17.	Students were encouraged to use elements of abstraction (e.g., symbolic representations, diagrams, schemes) when it was important to do so.	Not Core	2,7 ± 1,6
18.	The teacher required the students to link observed phenomena with existing scientific knowledge	Core	3,1 ± 1,9
19.	The teacher allowed students to be reflective about their research procedures	Core	2,3 ± 1,2

Table 3. Recoding of teachers' average score on each of the RTOP items

(\bar{x}_{ij})	Re-coding: quality of adoption	The inquiry aspect described by this item was:
0 – 0.5	Not occurred;	not adopted at all or not applicable in the context
0.5 – 2.5	Item not or scarcely descriptive: low	only weakly adopted in the practice
2.5 – 4.5	Item fairly or quite descriptive: medium	moderately adopted in the practice
4.5 – 6	Item very or perfectly descriptive:	definitively adopted in the

high	practice
------	----------

Table 4. Recoding of teachers’ average score on core and not core RTOP items

$(\overline{y_{c_{t_i}}})$ and $(\overline{y_{nc_{t_i}}})$	Re-coding: level of transformation	Inquiry aspects described by the items were:
0 – 0.5	Not occurred	not adopted at all or not applicable in the context
0.5 – 2.5	Items not or scarcely descriptive: heavy	weakly adopted in the practice
2.5 – 4.5	Items fairly or quite descriptive: some	moderately adopted in the practice
4.5 – 6	Item very or perfectly descriptive: almost no transformations	definitively adopted in the practice

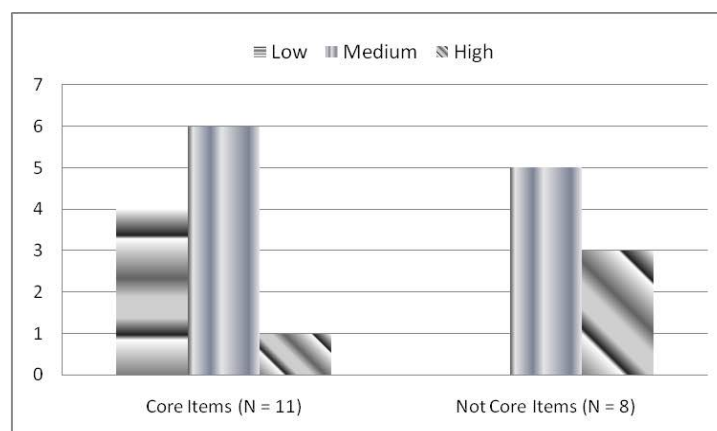

Figure 2. Distribution of the average scores of the core and not core RTOP items

Data show that, for the “core” elements, teachers’ average score was high only for one item (13), which refers to data collection, an important feature of the proposed TLSs. Such result suggests that teachers, on average, stressed the importance of quantitative measurements during the implementation. However, other aspects of inquiry seem to have been not fully adopted by the teachers. For instance, four items (1, 5, 14, 19) received an average score lower than 2.5, while six items (10, 11, 12, 15, 16, 18) received a medium average score. These items refer mainly to the nature of SI, as: relating the aims of the investigation to experimental evidences, the importance of the data analysis and of the communication of results; and to the autonomy of students as the generation of research questions and the reflection on the adopted procedures.

For the “not core” elements, there are no items which received a low-level score. The highest score items are 7, 8 and 9. These items concern aspects related to classroom discussions management and to the role of teacher as resource that help students construct their knowledge. This was an expected result since the peer discussion was implemented also during the training workshops when teachers acted as students. Medium-level score items (2, 3, 4, 6, 17) were related to timings of the activities and actual use of the provided materials.

The diagram in Figure 3 shows the $\overline{y_{c_{t_i}}}$ and $\overline{y_{nc_{t_i}}}$ scores for the seven teachers. Data show that, for all teachers, scores related to core items are lower than those of the not core items. A plausible reason for this result may be that the “not core” aspects likely required teachers changes to their usual way of teaching that could be effectively implemented even after a short training. On the contrary, core aspects were much more different with respect to usual school practice and likely needed more training time to be embedded in classroom practice (Blanchard et al., 2010).

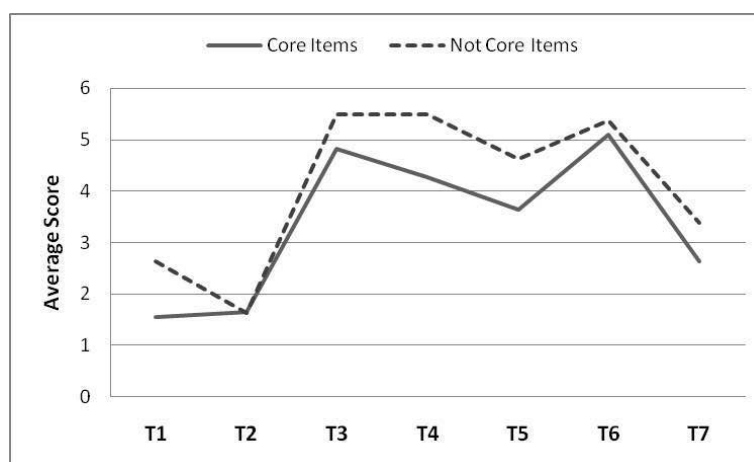

Figure 3. Average scores of teachers on core and not core RTOP items

When analyzing in more detail the teachers' scores, we note that only two of them (T1 and T2) obtained very low scores (less than 2.5 on a scale of 6) in both "core" and "not core" items. According to our scoring criteria, these teachers mostly *transformed* the inquiry aspects of the chosen TLSs in their practice. When further looking at the field notes and the video for identifying possible reasons for such scores, we noted that these teachers delivered the TLS as a teacher centered lesson and enacted the experimental activities as desk-demonstration. Moreover: (i) research questions were not generated by students; (ii) poor data analysis was suggested or carried out by teacher him/herself to get the "right" result; (iii) there was little reflection on what students had been done. Incidentally, both teachers were from the same school (a scientific lyceum) and the more directive attitude towards the students usually enacted in this type of school may have influenced their performances.

Three teachers (T3, T4 and T6) obtained high scores (greater than 4.5) in both "core" and "not core" items. According to our criteria, they hence made *almost no transformation* of the proposed approach. All these teachers were from vocational schools, where the teaching habits are less directive and more oriented towards laboratory practice. As a result, these teachers enabled students to generate and develop their investigations, to analyze data by themselves and managed students' questions and suggestions with a more constructivist attitude.

Finally, two teachers (T5 and T7) *transformed in some way* the proposed TLSs since they obtained medium level scores, especially in the core items of the protocol (between 2.5 and 4.5). Both teachers, while enacting some inquiry aspects in their activities, overemphasized experimental activities with the consequence that, for instance, students could not reflect on the adopted procedure and on validity of the collected data.

4. Discussion and conclusions

This study was aimed at investigating: (*RQ1*) the most accepted; and (*RQ2*) the most transformed aspects of inquiry when secondary school science teachers implement such an approach in their practice. Collected data suggest that the most accepted "core" aspects of inquiry have been: - students act as members of a learning community; - there is focus on data collection and on students' argumentations according to a research question. Moreover, the teachers were keen to act as resource persons and valued classroom discussions. The observed transformations were mostly related to a limited interpretation of inquiry potentialities. In particular, the following trends emerged: - introduction of the concepts related to the module before doing laboratory activities; - scarce attention to aspects of scientific inquiry as students' generation of the research questions; - forcing class discussions to get the "right" answer; - scarce importance given to group work. These findings suggest that professional development courses should explicitly point out possible transformations that could occur when implementing an innovative teaching approach as SI. Our results may also spread light on the factors at the basis of resonant teaching behaviors, which can plausibly favor the adoption of inquiry-based approaches in school practice. Further steps of this research study involve the analysis of post-implementation interviews and portfolios to collect more evidence about factors underlying teachers' transformations/difficulties in adopting inquiry-based approaches.

Acknowledgement

The research carried out in this paper was supported by the EC project: Chain Reaction - A Sustainable Approach to Inquiry Based Science Education, FP7-SCIENCE-IN-SOCIETY-2012-1, contract n° 321278

References

- Anderson, R.D. (2002). Reforming science teaching: What research says about inquiry. *Journal of Science Teacher Education*, 13, 1, 1-12.
- Barrow, L.H. (2006). A brief history of inquiry: from Dewey to Standards. *Journal of Science Teacher Education*, 17, 265-278
- Bigozzi, L., Tarchi C., Falsini P. & Fiorentini C. (2014) Slow Science': Building scientific concepts in physics in high school. *International Journal of Science Education*, 36, 13, 2221-2242
- Blanchard, M.R., Southerland, S.A. & Granger, E.M (2009). No silver bullet for inquiry: making sense of teacher change following an inquiry-based research experience for teachers. *Science Education*, 93, 2, 322-360.
- Blanchard, M. R., Southerland, S. A., Osborne, J. W., Sampson, V. D., Annetta, L. A. and Granger, E. M. (2010), Is inquiry possible in light of accountability?: A quantitative comparison of the relative effectiveness of guided inquiry and verification laboratory instruction. *Science Education*, 94, 577-616.
- Crawford, B.A. (2007). Learning to teach science as inquiry on the rough and tumble of practice. *Journal of Research in Science Teaching*, 44, 4, 613-642
- Jenkins, E. & Nelson, N. W. (2005). Important but not for me: students' attitudes toward secondary school science in England. *Research in Science & Technological Education*.23, 41-57
- Jones, M.G & Carter, G., (2007). Science Teacher Attitudes and Beliefs. In Abell S.K., Lederman N.G. (eds) *Handbook of Research on Science Education* (1067-1104). Mahwah, N.J.: Lawrence Erlbaum.
- Kleine, K., Brown, B., Harte, B., Hilson, A., Malone, D., Moller, K., et al. (2002). *Examining inquiry. Principal Leadership*, 3, 3, 36-39
- Luft, J. A.. & Pizzini, E. L. (1998). The demonstration classroom in-service: Changes in the classroom. *Science Education*, 82, 2, 147-162.
- Nam, J., Seung, E. & Go M. (2013) The Effect of a Collaborative Mentoring Program on Beginning Science Teachers' Inquiry-based Teaching Practice. *International Journal of Science Education*, 35, 5, 815-836.
- National Research Council (NRC, 1996) *National Science Education Standards*. National Academy Press: Washington DC.
- Ortlieb, E. T. & Lu, L. (2011) Improving Teacher Education through Inquiry-based Learning. *International Education Studies*, 4, 3, 41-46.
- Pintò R., Ametller J., Couso D., Sassi E., Monroy G., Testa I., Lombardi S. (2003) Some problems encountered in the introduction of innovations in secondary school science education and suggestions for overcoming them. *Mediterranean Journal of Educational Studies*, 8, 1, 113 - 134
- Rogers, E.M. (1983) *Diffusion of Innovations*. The Free Press, New York, NY
- Sassi E., Monroy G., Testa I. (2005). Teacher Training about Real-Time Approaches: research-based guidelines and materials. *Science Education*, 89, 1, 28 - 37.
- Sawada, D., Piburn, M. D., Judson, E., Turley, J., Falconer, K., Benford, R. & Bloom, I. (2002), Measuring reform practices in science and mathematics classrooms: The Reformed Teaching Observation Protocol. *School Science and Mathematics*, 102, 245-253.
- Sheffield Hallam University (SHU, 2009) *Earth and Universe Project Research Briefs*. On-Line, retrieved 11-08-2014, www.chreact.eu
- Stofflett, R. & Stoddart, T. (1994). The Ability to Understand and Use Conceptual Change Pedagogy as a Function of Prior Content Learning Experience. *Journal of Research in Science Teaching*, 31, 1, 31-51.
- Supovitz, J.A., & Turner, H.M. (2000). The effects of professional development on science teaching practices and classroom culture. *Journal of Research in Science Teaching*, 37, 963-980
- Van Den Akker, J. (1998) The Science Curriculum: Between Ideals and Outcomes. In Fraser, B.J. & Tobin, K.G (eds), *International Handbook in Science Education*, vol.2, (421-447). Dordrecht: Kluwer

Windschitl, M. (2003) Inquiry Projects in Science Teacher Education: What Can Investigative Experiences Reveal About Teacher Thinking and Eventual Classroom Practice? *Science Education*, 87, 1, 112-143

Affiliation and address information for corresponding author:

Alessandro Zappia

Department of Physics - University "Federico II", Naples

Complesso M.S. Angelo, Via Cintia, 80126 Napoli, Italy

e-mail: zappia@fisica.unina.it

Teacher and Professional Development in IBSE and Assessment

**Marián Kireš¹, Zuzana Ješková¹, Eilish McLoughlin², Odilla Finlayson²,
Margareta Ekborg³, Christina Ottander⁴**

¹ Faculty of Science, Pavol Jozef Šafárik University in Košice, Slovakia,

² Dublin City University, Ireland,

³ Malmö University, Sweden

⁴ Umeå University, Sweden

Abstract

Within the ESTABLISH FP7 project (www.establish-fp7.eu) the teacher and professional development framework for IBSE was developed and implemented in consortium of 12 partners' countries. The effective model for in-service and pre-service science teacher training in IBSE focuses on the developed and nationally adopted teaching units. The teacher education programme (TEP) is based on four core elements and four additional supporting elements. The four core elements are the minimum that is intended to be included in all training programmes and they provide teachers with basic skills of IBSE in order to be able to implement and develop inquiry activities in the classroom. The additional elements can be added with regard to teachers' experience and they involve Assessment of IBSE. The main focus of the FP7 project SAILS (www.sails-project.eu) is on TEP and the assessment strategies for IBSE. There are three cohorts of teachers with different levels of IBSE skills constituted. The 1st teacher cohort consists of teachers that have diverse experiences of IBSE. The initial assessment instruments have been prepared and are embedded within the professional development programs. The 2nd teacher cohort starts their TEP in IBSE including some of these assessment instruments within the IBSE teaching and learning materials. The last cohort begins training with IBSE units with fully integrated assessment frameworks, developed and piloted by help of previous cohorts.

Within the SAILS project we are working with pre-service and in-service groups of teachers in parallel. Based on both project experience there can be seen several typical features of specific groups. The pre-service students are without routine habits, more flexible for innovations, with attitudes closer to students' than teachers' view. On the other hand, in-service teachers are strongly focused on content and knowledge, they have their own approach to teaching and every change and innovation must be supported by strong arguments. As a result there is a strong need for presenting good examples of successful strategies in a form of IBSE case studies. Both groups' features charge us for changes and improvements of TEP that will be discussed within the contribution.

Keywords

Teacher education programme, in-service and pre-service teacher, inquiry-based science education

1. Teacher education programmes with focus on IBSE

Within the ESTABLISH FP7 project (www.establish-fp7.eu) the teacher and professional development framework for IBSE was developed and implemented in consortium of 12 partners' countries. Later on we have extended our courses within following fp7 project SAILS (www.sail-project.eu) in field of assessment, what will be mentioned at next chapter in more details. For us as project partner it was a big challenge even we have long year experiences with science teacher training. The topics related to inquiry science education and assessment were new and inspiring for us.

The teacher education programme (TEP) is based on four core elements and four additional supporting elements. We agreed on core elements regarding to wide range of inquiry in science education issues. The four core elements are the minimum that is intended to be included in all training programmes and they provide teachers with basic skills of IBSE in order to be able to implement and develop inquiry activities in the classroom. The additional elements can be added with regard to teachers' experience and they involve Assessment of IBSE. The following core elements (I – IV) for teacher education have been identified:

- I. Introduction to IBSE
Outline ESTABLISH view of inquiry, benefits to learning, role of inquiry in curriculum, provide direct experience of inquiry, ethical issues.
- II. Industrial Content Knowledge (ICK)
Industrial linking – provision of authentic experiences informed by industry or real applications.
- III. Science Teacher as Implementer - Management
Followed by implementation in classroom – key area here is for the science teachers to be prepared for implementing inquiry teaching/learning in their own classroom, identifying challenges.
- IV. Science Teacher as Developer – Feedback, Evaluation
Evaluation of classroom experience; identification of further needs – teachers should have experience and be equipped to implementing IBSE and start on the process of changing their own materials into inquiry based materials.

The science teacher education programme must support teachers to overcome the challenges and barriers that have been identified and discussed in the following areas:

- V. ICT
Develop confidence and competence in the effective use of ICT in teaching and learning of science and appropriate use in inquiry-based teaching/learning in inquiry.
- VI. Argumentation in the classroom
Address skills to develop and manage effective argumentation in the classroom.
- VII. Research and design projects for students
Providing authentic experiences, address the development of these ideas, what aspects provide authenticity, student ownership and endorsement.
- VIII. Assessment of IBSE
Address assessment of many aspects of inquiry; how assessments can be changed to provide value to the skills (cognitive, affective etc.) linked to IBSE.

It is envisaged that each country will implement elements I – IV in their in-service and pre-service science teacher education programmes but will incorporate elements V-VIII as required. Each element I – VIII is not necessarily of the same length and some elements may be considerably shorter than others. Common elements across the partner countries:

- Principals of inquiry
- Stages of inquiry
- Reasons why teachers should use an inquiry approach
- Assessment of inquiry skills and competencies
- Standards for inquiry skills
- Strategies for including formative assessment in teaching
- Self and peer assessment
- Support systems

The following are the minimum agreed criteria adopted for in-service science teacher education.

- Minimum total time for in-service: 10 hours
- Training is delivered over a minimum of three stages of inquiry.
- Strongly encouraged that the materials are trialled in real classrooms by participants.
- Recommended that a minimum of two teachers per school attend the workshops.
- Recommended that the workshops are hosted in the schools.

IBSE teacher training at pre-service level may only be introduced as ESTABLISH related, or with selected inquiry topics. The reason is we have so many approaches and different curricula in pre-service training. The “Guide for developing ESTABLISH teaching and learning units” is suggested to be used as teaching materials at pre-service level. They will use it within microteaching sessions or in their own teaching at school during the practice.

2. TEP focused on assessment strategies for IBSE

The main focus of the FP7 project SAILS (www.sails-project.eu) is on TEP and the assessment strategies for IBSE. Because of previous project Establish teacher training as well as based on assessment tools

development strategy within SAILS project there are three cohorts of teachers with different levels of IBSE skills constituted.

The **1st teacher cohort** consists of teachers that have diverse experiences of IBSE. The initial assessment instruments have been prepared and are embedded within the professional development programs.

The **2nd teacher cohort** starts their TEP in IBSE including some of these assessment instruments within the IBSE teaching and learning materials.

The **3rd teacher cohort** begins training with IBSE units with fully integrated assessment frameworks, developed and piloted by help of previous cohorts.

The 1st and 2nd cohorts allow us to expand awareness about IBSE with assessment instrument involved into Establish materials. We have been mainly focused on three areas of interest: Introducing to inquiry, Experiencing inquiry and Teacher as developer. More details about the TEP are shown in Table 1.

As an example of formative assessment tool for inquiry skills we introduced to participants rubrics with columns: skills, emerging, developing, consolidating, extending. For each skill related to IBSE activity we define and discussed with participants the meanings of each skill stage. Is it not easy task for participant without experiences with skills development to imagine real stage of selected skills. On the other hand, they prefer to use rubrics as a tool for identification of skill levels and as navigator for the next activities.

All the TEP materials are available on a project Establish web page (<http://www.establish-fp7.eu>) and SAILS (<http://sails-project.eu>), within the frame of COP (Community of Practice) Slovakia (Association of teachers using IBSE within natural science education).

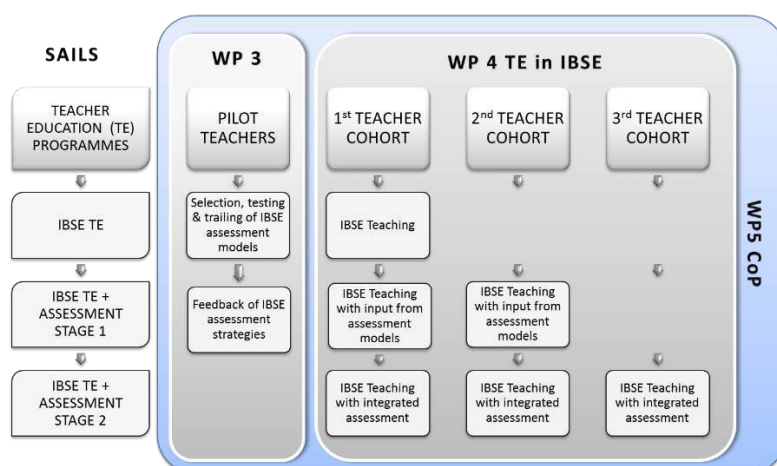

Fig. 1 SAILS three teachers cohorts strategy within project work packages 3-5

Table 1. Cohort 1 and 2 TEP of in-service teacher in Slovakia

Introducing to inquiry	Experiencing inquiry	Teacher as developer
Up-to-date science education problems	Introduction to the selected topics from IBSE point of view	How to implement inquiry activity in the classroom
Active learning strategies	Structure of teacher and classroom materials	Developing inquiry skills
What is inquiry-based science education	Teacher in the role of a student carrying out inquiry activities	Teacher as a developer of inquiry activities
Levels of inquiry	Assessment tools for selected activities	Assessment and evaluation of classroom experience
Inquiry in national curriculum		
Benefits to learning		

Finally we proposed the content and structure for TEP of Cohort 3, which we plan to apply at the turn of the year 2014. Details of the TEP with focus on assessment of IBSE activities are shown in table 2. Each 6 x 45 minutes forms one day session, in total we have 5 sessions.

Table 2. In-service TEP in Slovakia, Cohort 3 with focus on assessment of IBSE activities

Range	Aim	Activity	Resources
-------	-----	----------	-----------

2 x 45 min	Actual problems in science education, national strategy, scientific literacy	Interactive lecture, discussion, participant experiences	Presentation, national curriculum
2 x 45 min	Introduction to IBSE, levels of inquiry	Lectures with description and examples for each level of inquiry	Presentation, Establish and Sails IBSE activities, videos from school
2 x 45 min	IBSE material format, analysis of materials	Definition and recognition of the key elements of the teacher and student materials, worksheets	Establish and Sails IBSE materials for students and teachers, feedback tools
2 x 45 min	Inquiry skills and IBSE	Lecture with discussion	Scientific articles about skill, presentation
2 x 45 min	Initial training on Interactive lecture demonstration	Workshop, Step by step following through ILD activities	Establish and Sails IBSE materials in level of ILD
2 x 45 min	Initial training on confirmation inquiry (teacher as student)	Workshop, Step by step following through confirmation inquiry activities	Establish and Sails IBSE materials in level of confirmation inquiry
3 x 45 min	Initial training on guided discovery (teacher as student)	Workshop, Step by step following through guided discovery activities	Establish and Sails IBSE materials in level of guided discovery
3 x 45 min	Initial training on guided inquiry (teacher as student)	Workshop, Step by step following through guided inquiry activities	Establish and Sails IBSE materials in level of guided inquiry
3 x 45 min	Inquiry skill and assessment tools	Seminar, discussion about skills development, measurement tools	Sails materials, student worksheets
3 x 45 min	Formative assessment	Lecture and Seminar, discussion about formative assessment tools	Sails materials, student worksheets, teacher materials
3 x 45 min	Formative assessment II	Lecture and Seminar, discussion about formative assessment tools	Sails materials, student worksheets, teacher materials
3 x 45 min	Summary, presentation of own school practice	Lecture and Workshop, discussion about assessment tools for IBSE	Sails materials, student worksheets, teacher materials, teachers' thesis

Our materials, case studies and experiences from in-service TEP are transform into pre-service teacher training as a part of Didactic of Physics lectures and seminars during two semesters. We have on curricula 2 hours of lectures and 2 hours of didactics of physics lectures and seminars per week on each of two semesters. During each semester (14 weeks in total) we focused two lectures and two seminars on IBSE and assessment. Based on our three years experiences we can summarize and compare the features of pre-service and in-service teachers.

The pre-service students are without routine habits, more flexible for innovations, with attitudes closer to students' than teachers' view.

The in-service teachers mostly are strongly focused on content and knowledge, conservative for changes (they have their own approach to teaching), unconfident and every change and innovation must be supported by strong arguments.

3. Conclusion

A significant change in approach to physics education, which has been set by curriculum reform in Slovakia, needs wide and goal-directed preparations for education content, innovative methods and concrete tools to fulfil ambitious aims successfully. The role of teacher has been changing essentially; a teacher should be the one who encourages and operates student's active learning, stimulates constructivist approaches to vindicate meanings of scientific terms and understanding connections, watches and helps to reach a progress in inquiry skills development of students. Thanks of solving two fp7 projects there were created, nationally adapted, evaluated and put into teaching practice TEPs and set of IBSE activities with different tools for skills assessment.

Acknowledgement

This work is supported by the SAILS research project (SIS.2011.2.2.1-1, grant agreement 289085), which received funding from the European's Unions Seventh Framework Program and Slovak research and development agency grant VEMIV (Research on the efficiency of innovative teaching methods in mathematics, physics and informatics education) APVV-0715-12.

References

ESTABLISH project, available on <http://establish-fp7.eu/>

SAILS project, available on <http://sails-project.eu>

Laura Barron, et al. (2014). Profiling in-service teachers across Europe to determine their attitude to IBSE, In C. P. Constantinou, N. Papadouris & A. Hadjigeorgiou (Eds.), E-Book Proceedings of the ESERA 2013 Conference: Science Education Research For Evidence-based Teaching and Coherence in Learning. Part 14 (co-ed. Digna Couso and Loucas Louc), (pp.1-8) Nicosia, Cyprus: European Science Education Research Association. ISBN: 978-9963-700-77-6

Csapó, B., & Szabó, G. (Eds.) (2012). Framework for diagnostic assessment of science. Budapest: Nemzeti Tankönyvkiadó. http://edia.hu/sites/default/files/books/Science_Framework_English.pdf

Finlayson, O., McLoughlin, E., Brady, S. (2014). Evaluation of the impact of ESTABLISH IBSE Teacher education Programme on participating teachers, Proceedings of the SMEC conference: SAILS: Thinking Assessment in Science and Mathematics, 24-25 June 2014, Dublin City University, 7

Affiliation and address information for corresponding author:

Marián Kireš

Institute of Physics, Faculty of Science

Pavol Jozef Šafárik University in Košice

Park Angelinum 9, 041 54 Košice, Slovakia

e-mail: marian.kires@upjs.sk

Chapter 7

Physics Teaching and Learning in Informal Settings

Development of Students' Interest in Particle Physics as Effect of Participating in a Masterclass

Kerstin Gedigk, Gesche Pospiech

TU Dresden, Professur für Didaktik der Physik

Abstract

The International Hands On Particle Physics Masterclasses are enjoying increasing popularity worldwide every year. In Germany a national program was brought to live in 2010, which offers these appreciated events to whole classes or courses of high school students all over the year. These events were evaluated concerning the issues of students' interest in particle physics and their perception of the events. How several interest variables interact with each other and the perception of the events is answered by structural equation modelling (section 5.2). The results give information about the events' effects on the students' interest development in particle physics, show which event features are important (e.g. the authenticity) and give information about practical approaches to improve the effects of the Masterclasses. Section 5.3 deals with a group of participants which have a high interest in particle physics 6-8 weeks after the participation. The number of these students is remarkable large, with 26% of all participants. The investigation of this group shows that the Masterclass participation has the same positive effect on both sexes and all levels of physics education.

Keywords

Interest, evaluation study, particle physics research, informal physics teaching and learning, upper secondary education: ages between 15-19

1. Introduction

An important concern of physics education is the support of interest in physics issues and phenomena (cf. Berger 2011, p. 99). This interest creates a basis for young people to deal with scientific questions and their social connections, beyond the school education, i.e. "to become lifelong learners and to maintain a sense of wonder about the world around them" (cf. BMBF 2007, p. 159). Another aim of physics education, in addition to the teaching of content, is to offer an insight into modern research processes and questions. These issues enable students to get an adequate picture of nature of science and scientific knowledge gain.

All these issues are taken up by events about particle physics for high school students, so called "Particle Physics Masterclasses" offered by the German national program "Netzwerk Teilchenwelt" (English: network particle world). This is a network of 24 German particle physics research institutes and CERN¹. In this network high school students, physics teachers and particle physicists, who are involved in the program, are enthusiastic about particle physics. The network offers a wide range of activities for students and teachers whereof the Particle Physics Masterclasses build the basic level. This contribution deals with the evaluation of these events, concerning the supporting effects on students' interests in physics and particle physics. Some important results of this evaluation study are presented.

2. The Particle Physics Masterclasses

The Particle Physics Masterclasses are inspired by the International Hands On Particle Physics Masterclasses, which take place every year in March around the world. With the network's offering of the Particle Physics Masterclasses, high school students can join comparable workshops all over Germany throughout the year and it is possible that whole classes or courses of high school students can participate in such a Masterclass. Every year the network conducts about 120 Masterclasses. They last between 4 to 6 hours and mostly take place in schools with whole classes or courses. The facilitators of these workshops are young particle physicists, typically PhD students who sometimes are assisted by school students or teachers.

¹ European Organization for Nuclear Research (near Geneva/ Switzerland)

Such a Masterclass typically starts with an introductory talk of the young facilitators about the particle physics research, how it is conducted, how scientists work together in an international collaboration, which questions are answered or should be answered by the actual research, why particle accelerators are that huge, how a particle detector like the ATLAS detector² is working etc. Then the participants get an introduction and exercise how to identify particles by analysing their detector traces. Afterwards the high school students do own measurements with original data from CERN. Thereby they typically work together in pairs to classify about 50 to 100 decay events into different categories. The results of all groups are combined. In a joint discussion, by using statistical methods, they achieve a fundamental result of the recent particle physics research.

The overarching aim of the Masterclasses is to give high school students an insight into the modern physics research, especially the particle physics research, in an authentic way. The authenticity includes on one hand making original data from CERN available for high school students and teachers. On the other hand the authenticity should be achieved by the creation of an authentic setting in the Masterclasses. This includes the direct contact with real scientists, the use of a software which is close to the one which is used by the scientists and applying similar methods to interpret and compare their results with the predictions within the standard model of particle physics. A central aim is to support the students' interest development in particle physics. Individual students should be stimulated to do particle physics in their free time or e.g. to join voluntarily the higher levels of the network program. (cf. Gedigk et al. 2014 p. 397)

Students or teachers interested to know more about particle physics than they experienced by attending a Masterclass, can join the higher levels of the network program. For high school students the possible activities in the higher levels are proliferating their experiences with particle physics, participating in workshops or project weeks at CERN or conducting their own research projects.

3. Research questions and theoretical frame

The objectives of the evaluation study are twofold:

1. the examination of the effects of the Masterclass participation on the students' interest development in particle physics,
2. to provide indications how the effect of the Masterclasses could be improved, especially concerning the implementation of the events.

The basis of this investigation is formed by the person-object-theory of interest by Krapp: "An interest represents a (...) specific relationship between a person and an object" (Krapp 2002, p.387). Object in this respect "can refer to concrete things, a topic, an abstract idea, or any other content of the cognitively represented life-space" (Krapp 2002, p.387). The interest relationship between the person and the object is characterized by cognitive, "value-related and feeling-related valences" (Krapp 2002, p.388). This means that the person which is highly interested in an object (in best case) feels cognitively activated and "subjectively affected" by the object of interest of and experiences a "relevance for his or her sense of self" (Krapp 2002, p.388). For that reason it is useful to distinguish between cognitive, emotional and value-related components of an interest relationship.

The more often and the more intensive a person interacts with the object of interest the more stable the interest relationship becomes. Furthermore, the development of this relationship also depends on the situation or the context in which the person is operating with the object (Krapp 1992, p. 308).

Another aspect for developing interest is the learning in an authentic setting (e.g. cf. Kuhn et al. 2010, pp. 6, 10; cf. Euler 2009, pp. 802, 805). Therefore to evaluate the perceived authenticity of the event was an important aspect of the investigation. On the other hand it is difficult to achieve long-term effects on the interest by a one day event (cf. Euler 2009,). However, as particle physics does only play a small role in the German school curricula, the special interest in this topic is assumed to be influenceable by a Masterclass participation. The interest in physics as a subject and as profession is assumed to be relatively stable, because they were created over several years of physics education. The crucial factors for being engaged to do particle physics beyond the Masterclass are supposed to be the interest in particle physics itself, the (realized) intended actions of interest in particle physics and the interest in participating in the network

From this the research question follows:

How does the authentic setting of this one-time event affect students' interest development in (particle) physics? Concretely the following questions are examined in this article:

² ATLAS in one of the four particle detectors which is used at the Large Hadron Collider at CERN

- Are students' interests in physics in general and particle physics in particular fostered by a Masterclass participation?
- Can long-term effects be seen?
- Are there differences in the interest development between several participant groups? (e.g. gender, age, type of school, etc.)
- How do different interest and event variables affect each other? Especially which event properties are related to interest changes and which factors can be identified, that are crucial for a positive perception of the events?
- Is there a group of participants with a high interest in particle physics after the Masterclass? What is characteristic for this group (e.g. age, type of school, gender, ...)?

4. The evaluation study

To measure the different aspects of interest of the participating high school students an interest questionnaire was developed, tested in a pilot study and then improved. It is based on existing interest questionnaires which were recently used to evaluate out-of-school learning laboratories (e.g. Pawek 2009, Engeln 2004) and was adapted to the specific format and content of the Particle Physics Masterclasses. It contains items with closed answer format with a 5-point Likert scale.

For determination of the interest changes the evaluation study follows a pre/ post/ follow-up design. The students filled in the questionnaire at the beginning, at the end of the Masterclass and again after a 6 to 8 week period. The follow-up evaluation enables the investigation of the sustainability of the Masterclasses. Additionally a control group was evaluated with the same instruments and the same procedure, which means that students attending the same school levels were asked, who did not take part in a Masterclass.

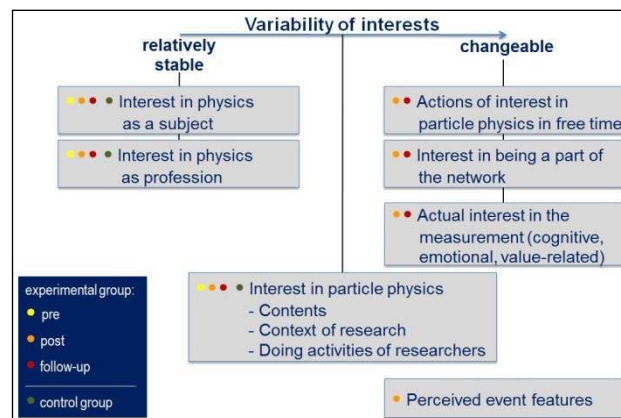

Figure 1. Selection of evaluated variables with the assumed stability

Figure 1 shows a selection of the evaluated variables. As described in section 3 we distinguish relatively stable and changeable interest variables. It was considered important to ask in the follow-up evaluation for realized "actions of interest" as this was an indicator for the interest of taking part in the higher levels of the network program. For that reason these variables are called target variables. One of the control variables were the "perceived event features". Examples for the items and the internal-consistency coefficients (Cronbach's alpha) of the variables are presented in Gedigk et al. (2014, p. 404).

5. Selected results of the evaluation study

The evaluation study was conducted from October 2011 until May 2012 in 25 Particle Physics Masterclasses with about 500 high school students ("experimental group"). In this article selected crucial results are presented below. More results, for example the comparison between experimental and control group, can be found in Gedigk et al. (2014).

5.1 Description of the sample

The experimental group consists of four main groups with different educational background, shown in figure 2. It describes the participants of the evaluated Particle Physics Masterclass (N=195) without those students, who already attended a Masterclass before and without students with incomplete data. Furthermore only

students attending with their whole class or course were included. Individual students ("selected students") were excluded, because this group shows much higher pre-interests in comparison to the group of whole classes or courses.

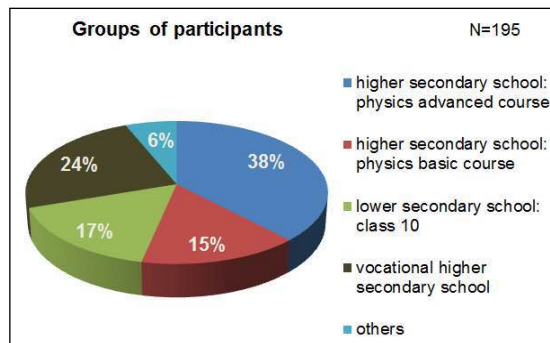

Figure 2. Groups of participants in the experimental group

A fifth of the experimental group is female. About 86% of these students state, they did not have the choice whether to participate or not. But 89% declare that they looked forward to the Masterclass.

5.2 The mechanism behind interest development

To investigate how different evaluated variables are related, a structural equation model was developed. The model offers an overview how the one-time intervention of participating in a Masterclass affects students' interest development in particle physics. It was developed on the basis of the interest construct theory (section 3) and chronological considerations. According to the aims of the Masterclasses (see section 4) the most important long-term target variables are the interest in particle physics and (realized) intended actions of interest in particle physics in the follow-up evaluation (marked blue in figure 3). As one of the goals of the evaluation is to get hints for optimization of the Masterclasses (see section 4) in the centre of the model is the focus variable of the perceived event features (marked orange), because this among other things also depends on the implementation of the Masterclasses.

The structural equation model was implemented with the statistical software AMOS 22, using maximum likelihood estimation. Key elements of the model are the seven latent variables, which are presented with an elliptical shape in figure 3. Each of them is related to two or three directly measured variables which are represented with rectangular shape. This is based on the assumption that recently measured variables and their correlations can be explained with a non-observable (=latent) background variable. Particularly important are the directed connections between the latent variables, which represent regression paths. These are based on theoretical and chronological considerations (cf. Kline 2012, p. 113).

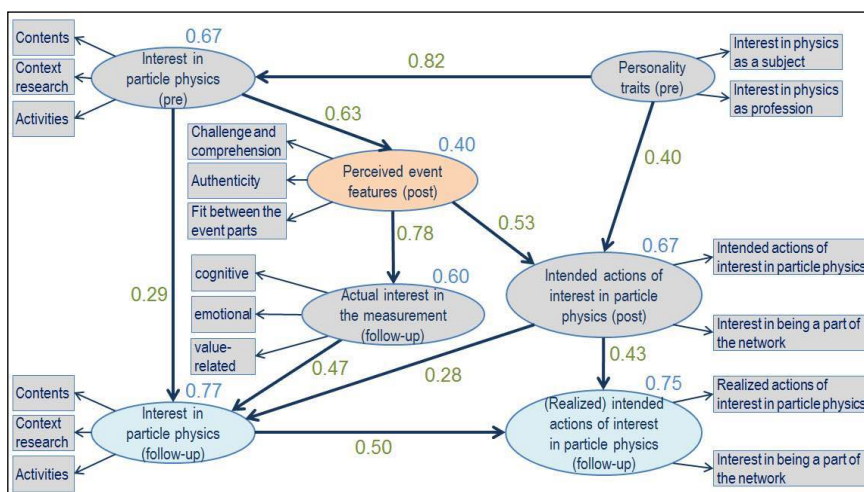

Figure 3. The mechanism of action between the interest and event variables. Arrows: (directed) regression paths. Variables with elliptical shape: latent (or unobserved) variables. Variables with rectangular shape: measured (or observed) variables, indicators of the according latent variables. Green numbers: estimated standardized regression weights; all of them are significantly different from zero at a 0.001 level. Blue numbers: estimated proportion of the variance of the variable that is accounted for by its predictors.

The numbers given in the model are estimated values which have the minimal difference to the data w.r.t the maximum likelihood estimation. Blue numbers stand for the estimated proportion of the variance of the according latent variable, “that is accounted for by its predictors” (Arbuckle, p.74). For example, 67% of the variance of the interest in particle physics at the beginning of the Masterclass is explained by the personality traits. The green numbers are estimated standardized regression weights of the according regression path. For example, if the personality traits of two persons are compared, the person with a higher personality trait of one standard deviation is expected to have a higher interest in particle physics at the beginning of the Masterclass by 0.82 standard deviations (i.e. 82 percent of the standard deviation). Furthermore the model gives information about the most important effects and several effect sizes. The model fits the data very well, as several fit indices confirm, shown in table 1. We choose as criteria the most commonly used fit indices (e.g. Pawek 2009, p. 150, Rudolf 2012, pp. 355-358). Concrete formulae for these indices can be found in West et al. (2012, pp. 212 ff).

Table 1. Fit indices for structural equation models. χ^2 : chi-square statistic; *df*: number of degrees of freedom; CFI: comparative fit index; RMSEA: Root Mean Square Error of Approximation; SRMR: Standardized Root Mean Square Residual. Criteria for the indices, cf. West et al (2012, p. 212, 213, 219), ° cf. Rudolf et al (2012, p. 365). Right column shows the values for the model depicted in figure 3.

Fit index	Criterion for good fit	Criterion for acceptable fit	Values for our model
χ^2/df	$\leq 2.5^\circ$	< 5	1.825
CFI	≈ 1	> 0.95	0.955
RMSEA	< 0.05	< 0.08	0.065
SRMR	< 0.05	< 0.10	0.052

We start the explanation of the model shown in figure 3 from the focus variable (perceived event features). It is assumed to affect the target variables via the intended actions of interest in particle physics at the end of the Masterclass and via the actual interest in the measurement in the follow-up evaluation.

On one hand the focus variable of the perceived event features depends on the real event features, which may be influenced by the implementation of the events. On the other hand it also depends on the subjective individual perception. Pursuing this path further backwards the relatively stable personality traits, which represent the interest in physics as subject and profession, in general, act via the special interest in particle physics on the perception of the event.

As can be seen in figure 3 the paths via the focus variable of the perceived event features have an influence on the long-term interest development in particle physics. The comparison of the standardized regression weights shows that the influences on the long-term target variables of the perceived event features are in a comparable size (dimension) to the direct effects of the personality traits and the interest in particle physics at the beginning of the Masterclass. But the model shows also that these latter variables affect the perception of the event, so that 40% of the variance of the perceived event features is explained by them. For this reason table 2 shows the standardized total effects of these and the perceived event features on the long-term target variables, which means that direct and indirect effects are added to a total effect. A standardized total effect corresponds to a standardized regression weight. The determined values of the standardized total effects show again that the perceived event features affect the long-term target variables in a comparable effect size to the personality traits and the interest in particle physics at the beginning of the Masterclass.

Table 2. Standardized total effects, columns affect rows

	Personality traits (pre)	Interest in particle physics (pre)	Perceived event features (post)
Interest in particle physics (follow-up)	.61	.61	.51
(Realized) intended actions of interest in particle physics (follow-up)	.60	.45	.49

As these results show the perceived event features have a relatively strong influence on the students' long-term interest development in particle physics. This is a surprising result, because the Masterclass is an one-time event, which only lasts between 4 to 6 hours. Results from comparable recent studies show that such one-time events do not have a big influence on long-term special interests (e.g. Pawek 2009, p. 151).

The following question immediately raises: which factors affect the perception of the event features, besides the personality traits and the interest in particle physics in the pre evaluation? Especially, which objective event properties have an influence? Some answers are given in Gedigk et al. (2014, p. 402): The perception of the event features depends e.g. on the prior knowledge in particle physics, the gender and the type of measurement.

In summary, the developed model fits the data very well and it shows that the event variables have a considerable influence on the long-term interest in particle physics of the young participants. It gives information about practical approaches to improve the Masterclasses' effects and can be used for further investigations of these events.

5.3 Group with high interest in doing particle physics after participating in a Masterclass

The Masterclass participation can be called particularly successful for those participants, who are interested in doing particle physics beyond the Masterclass (cf. aims of the Masterclasses, section 2). For this reason it is investigated, if there is such a group and what characterises this group (cf. research questions, section 3).

The evidence for a long-term interest in particle physics are the (realized) intended actions of interest in particle physics in the follow-up evaluation. It plays no role if the students intend to be a part of the network or if they do actions of interest in particle physics in their free time. So on the basis of the questionnaire students were chosen who had a high interest in being a part of the network (upper 20% of the participants) or who realized actions of interest in particle physics (also upper 20%). This resulted in a group of 51 participants of 195 (cf. section 5.1), corresponding to 26%. This group in the following is called "*success group*".

To characterize this success group χ^2 -independence tests were used (cf. Bortz, Schuster 2010, pp. 137 ff.) for the investigation of the relation between this success group and gender and between the success group and level of education (grade or school type) (cf. section 5.1). These tests show the independence of the success group on gender ($\chi^2=0.99$; $p=0.32$) as well as on level of education ($\chi^2=3.51$; $p=0.32$). These are remarkable results, implying that practically all students have a similar probability to develop a long-term interest in particle physics.

For a further characterization of this success group it was investigated if the success group rate the perceived event features better than the other participants. Table 3 shows the results of the corresponding t-tests with the effect size Cohen's d. The success group indeed assesses the features better than the others with medium effect sizes (cf. Bortz, Döring 2006, p. 606), whereby the biggest difference occurs regarding to the authenticity. These results confirm the structural equation model shown in figure 3.

Table 3. Differences in the perceived event features between the success group and the others. Right column: Cohen's d as effect size for a significant difference between the means of the groups, t-test for independent samples was used with: ** $p<0.01$ or *** $p<0.001$.

		Success Group (N=51)		Others (N=141)		Cohen's d
		Mean	Standard Deviation	Mean	Standard Deviation	
Perceived event features (post)	Challenge and Comprehension	2.71	0.84	2.27	0.83	0.54**
	Authenticity	3.04	0.69	2.63	0.65	0.61**
	Fit between the event parts	2.67	0.81	2.30	0.83	0.45**

Another remarkable characteristic of the success group is that there is no significant difference between the intended actions of interest in the post evaluation (M 2.68, SD 0.87) and the realized actions of interest in the follow-up evaluation (M 2.72, SD 0.65). This was tested with a t-test for paired samples ($t=0.44$; $p=0.67$). This means that this group realizes its intentions according to the actions of interest in the free time within those 6 to 8 weeks, which exceeds the expectations.

To sum up the success group shows that an interest in particle physics can be supported or stabilized for a considerable part of the participants. On the whole it seems that the potential for joining the higher levels of the network is much bigger than the network capacity (cf. Gedigk et al., p. 397). It is a very positive result that the format of the Masterclasses seems to be able to sustain interest independently from gender and class or school form.

6. Conclusions

A model was developed showing which variables are important for the interest development of the participants in a particle physics Masterclass. It fits the data very well (table 1) and shows how interest and event variables influence each other (figure 3). On one hand this offers the opportunity to find practical approaches for improving the effect of the events. On the other hand it makes it easier to investigate the effects of Masterclasses again, e.g. when the implementation will be changed systematically. Furthermore the model (and the questionnaire) could be adapted for similar event formats, to investigate the interest development of the participants. It is remarkable that the event variables have a considerable influence on the students' interest development in particle physics (c.f. table 2).

Section 5.3 describes a group of Masterclass' participants which have a high interest in being a part of the network or in actions of interest in particle physics, 6 to 8 weeks after the Masterclass participation. It is remarkable that this group is independent from gender and class or school form. Furthermore this "success group" is much bigger (26%) than the network capacity for joining the higher levels. So the Masterclasses have a big potential to inspire high school students for doing particle physics.

Acknowledgement

We thank Michael Kobel for the possibility to evaluate the particle physics Masterclasses of the "Netzwerk Teilchenwelt" and for his support.

References

- Arbuckle, J. L. (2012). *IBM SPSS Amos 21 User's Guide*. [online], [cit. 24.11.2014]. Available from: ftp://public.dhe.ibm.com/software/analytics/spss/documentation/amos/21.0/en/Manuals/IBM_SPSS_Amos_Users_Guide.pdf
- Berger, R. (2011). *Interessen im Physikunterricht*. In: Wiesner, H., Schecker, H., Hopf, M. (eds.): *Physikdidaktik kompakt*. Aulis Verlag. (pp. 99-105).
- BMBF (Ed.) (2007): *Zur Entwicklung nationaler Bildungsstandards, Expertise*, Bundesministerium für Bildung und Forschung (BMBF), Bonn, Berlin 2007. [online], [cit. 15.12.2014]. Available from: http://www.bmbf.de/pub/zur_entwicklung_nationaler_bildungsstandards.pdf
- Bortz, J., Döring, N. (2006). *Forschungsmethoden und Evaluation*. Springer Verlag, Berlin, Heidelberg.
- Bortz, J., Schuster, C.(2010): *Statistik für Human- und Sozialwissenschaftler*. Springer Verlag, Berlin, Heidelberg.
- Engeln, K. (2004): *Schülerlabors. Authentische, aktivierende Lernumgebungen als Möglichkeit, Interesse an Naturwissenschaften und Technik zu wecken*. Logos-Verlag, Studien zum Physiklernen 36, Berlin.
- Euler, M. (2009): *25 Schülerlabore: Lernen durch Forschen und Entwickeln*. In: Kircher, E., Girwidz, R., Häußler, P. (eds.): *Physikdidaktik. Theorie und Praxis*. Springer Verlag, Berlin, Heidelberg. (pp. 799-818).
- Gedigk, K., Kobel, M., Pospiech, G. (2014): *Development of interest in particle physics as an effect of school events in an authentic setting*. In: Dvorak, L.: *ICPE-EPEC 2013 Conference Proceedings*. (pp. 396-404). [online.], [cit. 28. 10. 2014]. Available from: http://www.icpe2013.org/uploads/ICPE-EPEC_2013_ConferenceProceedings.pdf

- Krapp, A. (1992): *Das Interessenkonstrukt*. In: Krapp A., Prenzel M. (eds.): *Interesse, Lernen, Leistung*. Aschendorff, Münster. (pp. 297-329).
- Krapp, A. (2002): *Structural and dynamic aspects of interest development: theoretical considerations from an ontogenic perspective*. In: Boekaerts, M, Boscolo, P.: *Learning and Instruction 12*, Issue 4. (pp. 383-409). [online], [cit. 23. 10. 2014]. Available from: <http://www.sciencedirect.com/science/article/pii/S0959475201000111>
- Kline, R.B. (2012): *Assumptions in Structural Equation Modeling*. In: Hoyle, R. H. (ed.): *Handbook of structural equation modeling*. (pp. 111-125).
- Kuhn, J., Müller, A., Müller, W., Vogt, P. (2010): *Kontextorientierter Physikunterricht. Konzeptionen, Theorien und Forschung zu Motivation und Lernen*. PdN-PhiS, 5(59), pp. 5-20.
- Pawek, C. (2009): *Schülerlabore als interesselördernde außerschulische Lernumgebungen für Schülerinnen und Schüler aus der Mittel- und Oberstufe*. Dissertation. Christian-Albrechts-Universität zu Kiel, Kiel. Mathematisch-Naturwissenschaftliche Fakultät. [online], [cit. 10. 06. 2014]. Available from: http://www.dlr.de/schoollab/Portaldata/24/Resources/dokumente/Diss_Pawek.pdf.
- Rudolf, M., Müller, J. (2012): *Multivariate Verfahren*. Hogrefe Verlag, Göttingen.
- West, S. G., Taylor, A. B., Wu, W. (2012): *Model Fit and Model Selection in Structural Equation Modelling*. In: Hoyle, R. H. (ed.): *Handbook of structural equation modeling*. (pp. 209-231).

Affiliation and address information

Kerstin Gedigk
TU Dresden
Fachrichtung Physik
Didaktik der Physik
01062 Dresden
Germany
e-mail: kerstin.gedigk@tu-dresden.de

Gesche Pospiech
TU Dresden
Fachrichtung Physik
Didaktik der Physik
01062 Dresden, Germany
e-mail: gesche.pospiech@mailbox.tu-dresden.de

“Good Vibrations” - A Workshop on Oscillations and Normal Modes

Sara R. Barbieri¹, Marina Carpineti¹, Marco Giliberti¹, Enrico Rigon², Marco Stellato¹, Marina Tamborini³

¹ *Physics Department, University of Milan, Italy.*

² *Liceo Scientifico "Grassi", Saronno, Italy.*

³ *Liceo Scientifico "Bottoni", Milano, Italy.*

Abstract

We describe some theatrical strategies adopted in a two hour workshop in order to show some meaningful experiments and the underlying useful ideas to describe a secondary school path on oscillations, that develops from harmonic motion to normal modes of oscillations, and makes extensive use of video analysis, data logging, slow motions and applet simulations. Theatre is an extremely useful tool to stimulate motivation starting from positive emotions. That is the reason why the theatrical approach to the presentation of physical themes has been explored by the group “Lo spettacolo della Fisica” [Spettacolo della fisica 2014] of the Physics Department of University of Milano for the last ten years [Carpineti et al. 2011; Carpineti et al. 2006] and has been inserted also in the European FP7 Project TEMI (Teaching Enquiry with Mysteries Incorporated) [Temi 2014] which involves 13 different partners coming from 11 European countries, among which the Italian (Milan) group. According to the TEMI guidelines, this workshop has a written script based on emotionally engaging activities of presenting mysteries to be solved while participants have been involved in nice experiments following the developed path.

Keywords

Oscillations, theatre, secondary education.

1. Introduction

Harmonic oscillations and normal modes are key physical concepts. They are fundamental in quantum physics [Giliberti 2007, Smith 2010], in electromagnetism (especially in treating coupled oscillating circuits and electromagnetic waves), in acoustics and in mechanical systems. The conceptual and practical importance of normal modes emerges also clearly from the fact that every small and sufficiently smooth oscillation of a complex system is given by a linear superposition of its normal modes [Barbieri 2012, Fitzpatrick 2013]. Furthermore, normal modes give also a way of introducing students to the basic concepts of the Fourier Transform in a meaningful way within a phenomenological approach. Moreover, normal modes are important conceptual organizers that allow a unifying approach to many different physics topics, giving students a deeper and also a faster way to face different contexts.

Nevertheless, in teaching practice (at least in Italy), only short time is devoted to harmonic motion, rarely coupled oscillators are treated and, in secondary school text-books, normal modes are usually not even present.

Potentially high impact curricular innovations, as the one we are proposing here, need to be clearly highlighted to be implemented in schools. As a consequence, a necessary step in this direction implies to give, besides disciplinary topics, also methodological and didactical strategies to put forward. In this regard TEMI offers a didactical approach based on the 5E cycle [Bybee et al 2006, Sherborne et al 2014] to develop understanding of scientific concepts through a guided enquiry process (that is an inquiry process in which the problem is posed by the teacher, but the procedure and the solution are given by the students) that is broken down into the following 5 stages.

- Engage that catches students’ attention using mysteries and leads them in formulating the enquiry question.
- Explore when students try to answer questions by planning experiments and collecting observations and data.
- Explain when students try to make sense of the data, and show their “scientific” ideas to answer enquiry questions.

- Extend when students try to solve at related different problems using the gained conceptual understanding.
- Evaluate which is the phase of self and teachers assessing students' understanding and skills.

For what concerns the first, fundamental phase the TEMI project makes use of what we may call mysteries, that is unexpected and unfamiliar phenomena, as a key strategy to raise the attention and to challenge students' curiosity. One of the most effective way of using mysteries is by means of a theatrical grammar, an aspect of teachers' presentation skills that in TEMI is called "showmanship". Moreover, if we require that, besides teachers, also students make use of a due theatrical grammar, for instance making a short video or a short show concerning the mystery and its solution, also the other phases of the 5E cycle (from explain to extend phases) can be greatly improved.

In this workshop, a theatrical grammar is used to simultaneously achieve some different aims: to describe the general framework of our educational path on oscillations and normal modes (which is intended for students of the 11th and 12th grade, and that has been derived by a PhD designed based research); and to give a concise example of a Milan-TEMI inquiry lab that integrates skills with content, and that is devoted to the continuous professional development of teachers (CPD) towards IBSE, making reference to the model for teaching skills, known as the Gradual Release of Responsibility (GRR) model [Sherborne et al 2014], that is schematically structured in the three stages "I do it", "We do it" and "You do it".

The workshop contains two complete 5E cycles, the first one on harmonic motion [Giliberti et al 2014] and the second one on normal modes of oscillations.

For brevity, in the following we will describe in relative details only the first cycle, while the second one will be only outlined. To better get an idea of what we mean with "theatrical grammar", we will help from the script, of which we will also give some excerpts (in quotes) when appropriate.

2. 5E cycle on harmonic motion

Engage

The purpose is to catch the attention of the public and engage them with simple experiments on oscillation.

Realization: A lab-room, filled with experimental devices on oscillations, is shown together with three people dressed like a pack as a stage costume, Fig.1. A kit bag containing material for personal experiments on oscillations is put on each chair. Persons attending the workshop enter the room while the song "Good vibrations" by the Beach Boys is playing.



Figure 1. The stage while people enter the workshop room.

The workshop started with a slide showing two typical definitions of harmonic motions:

- a) Harmonic motion is the projection on a diameter of a uniform circular motion.
- b) An object performs harmonic motions if it is acted upon by a force $F = -kx$

“With definitions such as these, students do not go much further. Our experience with secondary students, and also with graduate students in mathematics, shows that the comprehension of the link between mathematics and physics in the study of oscillations is far from clear if we start this way. The bottom line is that the kinematic definition of harmonic motion a) is not enough to understand the physics implied and the dynamical definition b) is often ineffective. [...] In fact, the previous definitions prevents to grasp the

importance of the harmonic motion as a conceptual organizer that, instead, should emerge from the choice/recognition of particular deep similarities/diversities among different types of periodic motions.”

Therefore, the first engaging message is that “*We cannot deliver students pre-packed definitions (like those given above) since, in this way we would not give them instruments and concepts to analyse and read the world around them.*”

To emphasize this message, the three researchers unpack themselves and ask the public to synchronize a pendulum, taken from the kitbag, with the rhythm of a metronome that everyone can hear. What does the period of a pendulum depend on? Of course, attenders had to choose the right length, but in practical it is not quite so simple...

And now the guided inquiry engagement comes: many different types of oscillations are also shown, among them a ball oscillating inside a bowl, a mass-spring oscillator, a pendulum, a seesaw on a flat pivot and another one on a round pivot, a bouncing ball, a disk bouncing on an air table, a cycloidal pendulum a Waltenhofen pendulum.

Participants are asked to classify the previously seen motions into two or three categories, putting together the motions that, in their opinion, had particular similarities from a mechanical point of view, and then giving us a motivation for their choices.

It is interesting to observe that, facing the same task, the majority (~80%) of our secondary school students divided the oscillations according to the form of their trajectories: those having a rectilinear trajectory (such as a mass spring oscillator and a bouncing ball) were put in the same category and those having a curvilinear trajectory (such a pendulum and a ball on a curvilinear track) in another one. The remaining students (~20%), instead, were more impressed by damping and, therefore, put together oscillations having the same “intensity” of damping (such as a bouncing ball and the see-saw on the large flat pivot).

These data show the difficulty to look at things from a physical perspective, especially if the purpose is to come to a common agreement of the definition of harmonic motion and to a suitable understanding of it, starting from the typical vision of common sense as regards the oscillations.

Explore

An excerpt from the script can well introduce the explore phase. “*We are studying mechanics, right? What are the key concepts of mechanics? I’d say: forces and motion, so it seems to me probably meaningful and also fruitful to look at the forces that generate the previous motions.*”

A very qualitative approach, typical of an exploration phase follows. “*First I do it, then we do it all together. Look: this is a mass-spring oscillator: there’s an equilibrium position here... when I pull it downward, the force acting on the mass pushes upwards. And if I push the mass upward the total force acts downwards, towards the equilibrium position*”. Once a vertical coordinate is chosen, a qualitative graph of the force vs position can be drawn, Fig.2.



Figure 2. Graphs of the force vs position for a bouncing ball and for some other oscillatory motions.

Audience is asked to make a similar work with all the previously seen oscillations.

Now a comment taken from the script is compulsory:

“It is indeed very difficult for secondary school students to draw graphs like those just seen. But it’s worth to do it. In fact, in our experience, this operation increases students’ general ability in representing and reading graphs. Moreover, as we shall see in few moments, the path we propose, containing that difficult task, allows to recognise the anharmonicity or the harmonicity of a motion at a glance, even without knowing its equation of motion, nor its solution. In other words, without knowing the details of the forces involved [Giliberti et al 2014] that, sometimes, can be quite difficult to determine (as in the case of a ball rolling on a cycloid or in that of a seesaw oscillating on a round pivot). Therefore, making students familiar with the concept of a positional force, the introduction of the potential energy concept is then easier, and it can then conveniently be used in describing oscillations or in dealing with normal modes”

Explain

By the previously described guided procedure, one can gain the key observation that some oscillations are driven by a restoring force, which is a force that gives rise to a motion with a stable equilibrium position. Denoting by ξ the curvilinear coordinate, with the zero corresponding to the equilibrium position, the graph of the component of the restoring force along the trajectory, F_ξ , vs ξ will lie in the second and in the fourth quadrant. In this case the restoring force can be approximated by its tangent line in the origin, provided the amplitude of oscillation is small enough, Fig.3. So that, a body subjected to a sufficiently regular restoring force, and for small amplitude of oscillation, clearly obeys the equation of motion:

$$F_\xi = -k\xi, \quad (1)$$

(where k is a positive constant). Eq.(1) can be written as:

$$a = -\frac{k}{m}\xi, \quad (2)$$

where a is the acceleration and m is the mass of the oscillating body. Eq.(2) that can be taken as the definition of harmonic motion.

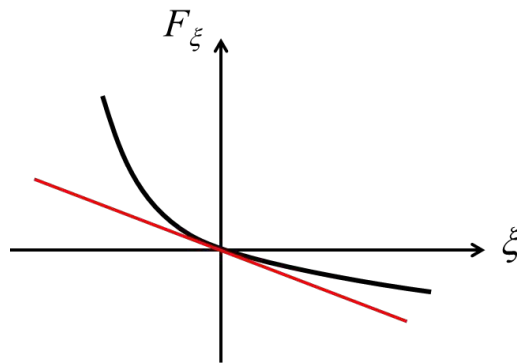

Figure 3. A restoring force and its linearization in the origin.

With little efforts, from Eq. (2) all the proprieties of harmonic motions can be obtained. One for all: the isochronism of oscillations.

Keeping in mind what we have just done, we are now induced to divide oscillatory motions into two categories: 1) those with harmonic small oscillations, 2) all the others. And by just looking at the qualitative graphs of the component of the force along the trajectory vs the curvilinear coordinate we can also suddenly and easily understand how often the (sufficiently) small oscillations of a body are harmonic. For example: the pendulum, the ball in the bowl, the mass-spring oscillator, all give rise to harmonic oscillations.

Extend

The extend phase is proposed towards two different directions. The first one is damping [Giliberti et al 2014], in fact, as said above, besides the trajectories of which we have just taken care, secondary school students were also interested in damping and, therefore, it is worth to consider it in our path. But, for brevity reasons, we do not linger on the damping in this paper. The second direction, that we are going to describe

here, is how to reach a deeper understanding of harmonicity through a comprehension of what harmonic is not.

We would like to dot the i's and cross the t's of our definition of harmonic motion. Preliminarily, it is important to stress that the harmonic motion defined by eq.(2) is not necessarily rectilinear, since ζ is, in general, a curvilinear coordinate. Then, it is also important to emphasize that F_ζ is only the component of the total acting force *along the direction of motion*, since in many cases the intensity of the total resultant force may be different from zero even in the equilibrium position; for instance when the contribution of its centripetal component is important; while, on the contrary F_ζ is, still, zero. The path towards the previous definition leads us to say that a one degree of freedom system performs harmonic oscillations in a neighbourhood of an equilibrium point if and only if

(a) the equilibrium point $\zeta=0$ is stable;

(b) the function F_ζ is continuous;

(c) the function F_ζ is differentiable;

(d) $\frac{dF_\zeta}{d\zeta}(0) \neq 0$.

With these conditions clear in mind, we are now able to realize at a glance the anharmonicity/harmonicity of an oscillation, and also we can understand the link with the mathematical aspects of the problem. Let us see how, with some questions/examples.

Q1) Are the oscillations of a disk bouncing back and forth on an air table harmonic or not? The answer is no, because it has not a stable equilibrium point (condition (a) drops).

Q2) An interrupted pendulum is a pendulum with a peg between the point of suspension and the equilibrium point, so to change the length of the pendulum for half an oscillation, Fig.4(a).

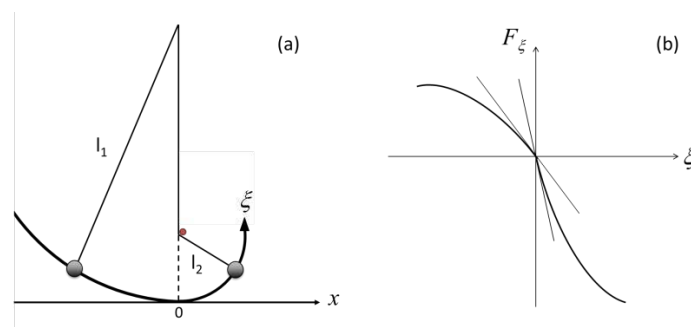

Figure 4. (a) An interrupted pendulum. (b) Graph of the ζ -component of the restoring force, F_ζ , vs ζ .

Are the small oscillations of an interrupted pendulum harmonic or not? No, they are not, because the function $F_\zeta(\zeta)$ is not differentiable (condition (c) drops), see Fig. 4(b).

It is interesting to observe that the period of the small oscillations of an interrupted pendulum is obviously isochronous, thus providing an example of a motion that is isochronous but not harmonic.

Q3) “[This is] a very subtle example: the case when only the condition (d) of our four-point criterion is not satisfied, that is when $dF_\zeta(0)/d\zeta$ is zero. In this situation, it is easy to demonstrate that, in the neighbourhood of the equilibrium point, the potential energy behaves at least as ζ^4 [Giliberti et al 2014]. The small oscillations can, therefore, be realized making a body slide on a track with a $y=x^4$ profile. Let’s try it. You have your own profile in the kitbag. Please take it out and make a ball roll on it and... play with it. Let’s see what happens. Near the equilibrium point, the track is nearly flat and the motion is nearly a uniform motion! Small oscillations are practically impossible to see. Nonetheless, when the amplitude is large enough, we can immediately realize that the motion is not isochronous and, therefore, not even harmonic.”

This last observation gives us a simple trick to understand when an oscillation is not harmonic: it suffices to listen to the rhythm it produces. If it is not constant, the oscillation is surely anharmonic.

Evaluate

Both, the self-evaluation (done by students themselves) and the evaluation (done by the teacher) is a systematic procedure that takes place during the whole path and not just at the end. Nonetheless, for clarity reasons, we give here an example of the final evaluation. It is taken from the final results of an evaluation questionnaire on harmonic motion, given to secondary school students during our experimentations in many schools. We consider here only the part concerning students' skills of classifying oscillations into categories (a more detailed, wide-range analysis is in progress). As already said, while before our path students classified oscillations according to their trajectories (80%) or to the "intensity" of damping (20%); after the path, the percentage of students that used a geometric criterion decreased to 48%, while as much as the 52% of them used the learned anharmonicity/harmonicity criterion to classify.

3. 5E cycle on normal modes of oscillation

Another complete 5E cycle has been devoted to normal modes.

For the *engage* phase two very intriguing experiments are shown. a) A wave-pendulum, that consists of a series of pendulums with different lengths so to have decreasing periods. When the pendulums are simultaneously released, they give the impression of a transverse wave that change its shape with time and, eventually, comes back to the initial condition. b) Two coupled pendulums in which the energy is gradually transferred from one pendulum to another.

The *explore* phase starts with the questions: Which are the similarities/diversities of the previous two systems? Is it possible to have a harmonic oscillation, when the oscillators are coupled?

To answer this second question we can build systems consisting of two to five physical pendulums coupled by identical springs. These systems are particularly useful: i) to easily introduce some particular (a student said "spectacular") configurations of motion for the entire system: the normal modes; ii) to recognize that when such a complex system oscillates in one of its normal modes, there is no energy exchange between its single parts (oscillators); iii) to see that every casual motion configuration of the system is a linear superposition of its normal modes. In discussing such systems, we find it particularly useful to use both, sonar data logging techniques and video analysis. In particular, slow motion video of 2 to 5 mass spring oscillator can clearly show the various modes of oscillations and the resulting relations among frequencies and the relative phases of each oscillator.

In the *explain* phase, some different mathematical explanatory schemas are discussed. Among these, we highlight an algebraic decoupling of the equations of motion of a two mass-spring oscillator system and a simple connection with the Fourier Transform also with the experimental tool of the FFT (Fast Fourier Transform) that can be very useful also in the description of systems with more degrees of freedom.

A general conclusion is also reached: in a system with n degrees of freedom, there are always n ways of producing a proper oscillation, such that each oscillator of the system performs harmonic motion. Moreover, a graphic and powerful way of determining the m^{th} mode of n coupled oscillators, in clear analogy with stationary waves on a rod, is given (see Fig.5 for a self-explanatory sketch of the method made by a secondary school student).

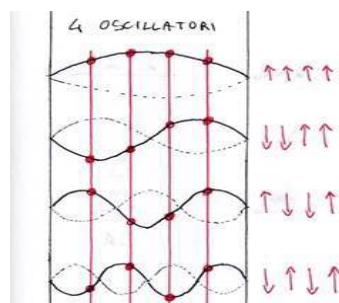

Figure 5. A schematic way of representing the 4 modes of oscillation of 4 coupled oscillators

In the *extend* phase the study of a Shive machine can be undertaken and also a qualitative study of the normal modes of Chladni plates can be done. Moreover, a research for the normal configurations of various more general systems, such as a circular moving track with a heavy ball rolling over while the track can oscillate itself, is of sure help in making the comprehension of normal modes deeper and wider. Even a two degree of freedom non-linear system, the parametric pendulum, that is a vertical mass-spring oscillator with

the spring frequency that doubles the pendulum-like one [Boscolo et al 2014] is an appropriate conclusive activity of the extend phase. The two normal modes of the parametric pendulum, that are obviously always independent for the linearized condition of very small oscillations, do instead largely interact, when in the resonant condition, with a very intriguing behaviour.

In the *evaluate* phase, a discussion of the results, obtained in classroom experimentations (through written questionnaires and oral interviews) and that brought us to the final version of our path proposed in this workshop, is done.

4. Conclusions

The experimental approach here described allows to overcome most of the mathematical difficulties of treating coupled oscillations in secondary school and can also shed light on some conceptual and disciplinary knots. Moreover, the combined use of data logging software and of video-tracking techniques can, in our experience, also enforce the exploration and explanation phase of the adopted 5E cycle and generate great enthusiasm in students. In fact, a student needs only a smartphone to produce a short video that focuses on the mystery to be explained, and he/she is then stimulated in proposing a solution. Students showed us many videos that they realized, even when we didn't ask them any.

“The notion of normal modes is a conceptual organizer. Every time we look around us, we cannot help but seeing a large amount of normal modes all in action. They are in the small ripples of the water in the harbour. They are in motion of the curtain cord. They are in every sound we listen, in every music. They are at the heart of quantum physics: what, but normal modes of vector potential, are the photons? Our universe has chosen the basis of the normal modes so that refracting prisms produce the rainbow. Even the Klein Gordon equation contains a harmonic term. What, if not an expansion in a Fourier series is the Ptolemaic system? So please enjoy the wonder and the mysteries of oscillations keeping in mind how much more beautiful they are when both a poetic and physical perspective are taken into account.”

Acknowledgements: This work was partially supported by Project TEMI, FP7-Science-in-Society-2012-1, Grant Agreement N. 321403; the authors thank Claudio Marconi for theatrical direction.

References

- Barbieri S. R., & Giliberti, M., (2012). *Laboratorio aperto: Oscillazioni e Onde*. Milano: CUSL.
- Boscolo I, Castelli F, Stellato M & Vercellati S. The parametric spring-mass system, its connection with non-linear optics, and an approach for undergraduate students, *arXiv:1402.5318*.
- Bybee, R., Taylor, J. A., Gardner, A., Van Scotter, P., Carlson, J., Westbrook, A., Landes, N. (2006). *The BSCS 5E Instructional Model: Origins and Effectiveness*. Colorado Springs, CO: BSCS.
- Carpinetti M., Cavallini G., Giliberti M., Ludwig N., Mazza C. & Perini L. (2006). Let's throw light on matter: a physics show for primary school, *Nuovo cimento della Società italiana di Fisica B* **121**(8), 901-911.
- Carpinetti M., Cavinato M., Giliberti M., Ludwig N. and Perini L. (2011). Theatre to motivate the study of physics, *JCOM* **10**(1), 1-10.
- Falstad (2014). Online simulations retrieved from www.falstad.com/mathphysics.html
- Fitzpatrick R. (2013). *Oscillations and Waves*, Boca Raton, Florida.
- Giliberti M. (2007). *Elementi per una didattica della fisica quantistica*, CUSL, Milano, Italy.
- Giliberti M., Stellato M., Barbieri S., Cavinato M. & Tamborini M. (2014). Detecting anharmonicity at a glance, *Eur. J. Phys.* **35** (6) 065012, doi:10.1088/0143-0807/35/6/065012
- Logger Pro software and reference manual (2014). Retrieved from www.vernier.com/products/software/lp/
- Sherborne T., Jordan J., Walker J. (2014). TEMI Report D4.2 (2014) <http://teachingmysteries.eu/wp-content/uploads/2015/01/D4.2-Pilot-Training-Programme-Feedback.pdf>
- Smith, W. (2010). *Waves and Oscillations-a prelude to quantum mechanics*. New York: Oxford University Press
- Spettacolodellafisica (2014). Available at <http://spettacolo.fisica.unimi.it>
- TEMI (2014). Available at <http://teachingmysteries.eu/en>
- Tracker software and reference manual (gen. 2014). Retrieved from www.cabrillo.edu/~dbrown/tracker

Affiliation and address information

Marco Giliberti

UMIL_PERG (University of Milan Physics Education Research Group)

Department of Physics

University of Milano

Viale Celoria, 16

20133 MI

Italy

e-mail: marco.giliberti@unimi.it

Chaos Theory and its Manifestations: An Informal Educational Activity to Explain Chaos to Students

Valeria Greco, Salvatore Spagnolo

Associazione PALERMOSCIENZA, Palermo, Italy.

Abstract

In spite of being present in many topics of classical physics and in everyday life, the chaos theory is not present in the Italian school curricula and textbooks. Chaotic dynamics are, in fact, involved in phenomena easily accessible to everyone or in events experienced by most people in their lives (the dripping of a faucet which keeps people awoken in the night, meteorology, traffic, population growth), but they don't know it and what chaos really is. Some people think that chaos is synonymous of mess – like in teenagers' rooms – or at best that it has a relationship with the unpredictable but they are not able to explain how or why. In this paper we propose a series of experiences related to the chaos theory. In particular, we will present three activities based on the Sinai billiard, a double pendulum and on a simple convection example. It is well known from the literature that these physical systems can have chaotic dynamics under certain particular conditions. These systems have the advantage that involve objects or everyday phenomena with which all people have or have had something to do; on the other hand, these systems allow some simple visualizations of the concept to be conveyed.

These experiences are developed to be managed in an informal setting, so that they can be implemented quite simply in schools or in science centers.

Keywords

Informal education, nonlinear system, chaos, double pendulum, Sinai billiard, convection.

1. Introduction

The most important feature of chaos theory is that the descriptive models developed have a strong dependence on the initial conditions, just as the phenomena which aims to describe. The mathematical models of this field are complicated and typically are based on tools or on a cultural background hardly possessed by people. Nonetheless, it is possible to find physical systems whose chaotic evolution is easily viewable through computer simulations or through experiences specially designed.

A good starting-point to introduce the theory is beginning from the laboratory that everyday life is.

Of course, a significant learning is characterized by the fact that the new concepts or ideas to learn is connected and put into relation with the ones already possessed by each person. So, the new ideas assume a meaning for everyone because people can increase and sometimes restructure their previous knowledge with new concepts.

On the other hand, the transmission of scientific knowledge must use new ways to communicate closer to the citizens and especially young people. Also, it is necessary to recognize the need to create a cultural environment suitable to the development of science and characterized by the fall of barriers between science and society. For years, the association PALERMOSCIENZA promotes the growth of scientific communication of young people and citizens outside usual formal structures.

In particular, the Association works with students with the idea that the informal educational activities aim to the development of concepts and to the key processes rather than to contents. We believe interaction and confrontation are indeed elements leading – if constantly and correctly attended for – to individual and collective growth of people in general and students in particular. So, we start from experiments and go on interacting with students in different ways, analyzing an everyday fact or phenomenon to come to understand abstraction. Through this process a significant learning is promoted.

2. Methodology

Significant learning is characterized by the fact that the new material to be learned is connected and correlated with the concepts and skills already possessed by the student. Therefore, new knowledge doesn't remain isolated, but it will be well connected with the previous cognitive structure of the student.

The challenge we face as PALERMOSCIENZA members, is to create an efficient and valid environment where formal and informal learning converge making significant learning achievable.

In opposition to formal learning (that is official, curriculum-fixed, scheduled, pedagogically designed with organized learning paths, controlled and often evaluated), informal learning is unofficial, serving a concrete purpose, unstructured, often uncontrolled and tacit.

People learn science not only when at the end of a cognitive process master a theory, solve an equation or are able to do practical work in laboratory (typical results of formal learning). Also, learning science means to be able to build and manage interpretative schemes where to place and to interpret scientific phenomena observed every day.

So it is important not only to know the concepts, but also to build, to use and to analyse models, to understand a phenomenon and to transform it between different representations. This process actualizes itself when the people communicate, argue, ask questions etc. and let to acquire not only knowledge but, above all, competences.

In order to achieve this result, we build situations where experiences and tools from formal and informal learning can be settled in new contexts. So, this environment could stimulate both the investigative attitude and fun inherent to scientific activities.

From a methodological point of view, we borrow strategies from open inquiry based learning education adapted to the informal learning environment where our experiences take place. So, we put people in a position to tackle questions, issues and controversies from real world, with the aim to solve problems or create solutions in collaboration.

Usually, we pose a problem or a case-study or we represent an experience and we ask to people, through an engagement, to design a solution. So people are involved in the construction of knowledge through active involvement. In contrast to the formal techniques of teaching and to formal learning processes, inquiry allows deep understanding in people in addition to the acquisition of knowledge and skills.

Moreover, typically people has preconceptions about the world. In this sense, the cognitive process stimulated by inquiry tends to eliminate misconceptions present before the deep understanding of the phenomenon. So, the main goal of inquiry method is not only to transfer scientific knowledge, facts, definitions, and concepts, but rather stimulates people to enhance their ability of reasoning. Moreover this method makes people independent learners capable of identifying main questions and to find relevant answers by a gradually acquisition and expansion of a body of scientific knowledge and abilities.

3. Educational Experiences

As we have just mentioned, a good starting point to introduce the theory is beginning from the laboratory that everyday life is or from a funny activity like a sport.

We proposed three different items to introduce the topic both to a group of students and to the workshop participants. The laboratory for students is organized to last three hours, the workshop two.

Laboratory Items



The first item was a Sinai table because a pool table is an object of common use among young (and not only) people that gives the opportunity to convey scientific concepts through everyday life experiences shared most likely by all the students. With the introduction of a circular element placed in the middle of the table, under certain conditions a little change of the ball starting point can cause chaotic behaviour and so it's impossible to predict its path.

Our intention was to involve students in the design of this object. So we asked to the students of Vincenzo Ragusa e Otama Kiyorama High School to build the pool table.

They built a table lighter and smaller than an ordinary one but they respected the ratio of a standard Italian pool table (ratio between sides 1:2). The surface of the table was composed by rigid solid wood covered by game table cloth and cushions were of vulcanized rubber without cloth. We spread talcum on the cushions



so that the balls rebounded five or six times before stopping. The students built a wood disc to place in the middle of the table to introduce chaotic elements. We know the table isn't perfect because there is more friction than a real pool table and the Fermat's Principle isn't respected perfectly. However for us it was more important the engage of students than to have a perfect object.



A second experience was based on the use of a double pendulum because it allows to locate within the context of deterministic classical physics a system that appropriately modified manifests chaotic behaviour. Such a system is particularly useful to understand what is the role played by the initial conditions in the dynamics of a physical system and to break the idea that chaos is present only in many-body systems.

In this case we asked a craftsman to build it. He used ordinary material like wood for the support of the pendulum and polycarbonate plastic for the arms. We used ball bearings to reduce friction to an absolute minimum between the arms. We use wooden table and bar to build the support for the pendulum. The last item was an equipment for experiences on fluid

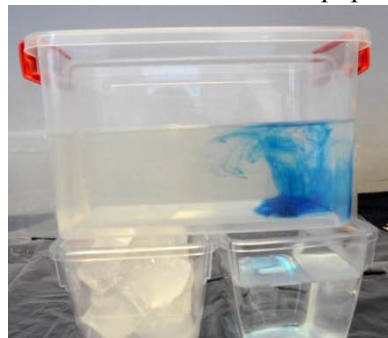

convection easily available in a school laboratory. Such an experience allows to present the context in which the theory of chaos is traditionally introduced looking at thermodynamics and meteorology (E.N. Lorenz, butterfly effect etc.)

We used a big plastic box for water and two smaller ones for ice and hot water. We placed the boxes as shown in the picture and used two eyedroppers to drop colours in the water in the big box.

Experiences vs students

We proposed the experiences to a group of fifteen students of the last year of an Italian high school. Starting with the idea that, in informal contexts, theory should emerge from laboratory activities, we used simple questions to present the objects without explaining how they worked to register students' reaction. We will not present here detailed statistical analysis of the responses, subject of a forthcoming publication, but here we want to report our activities and to point out the most interesting answers.

We introduced chaos laboratory starting from the question "What's chaos?". An interesting answer was "It is something you cannot explain with a first grade equation", that showed how it is normal for a student linking linearity to a first grade equation. The first example we introduced strengthened this idea because we chose a spring with a mass. In fact, this is a linear system and a little difference in the initial condition produces a small shift from the final position which would be obtained in the absence of perturbation. The second example was about the meteorology, in which systems depend on many variables. For students it is clearly a chaotic system and they gave us as an example many bouncing balls on the floor. We explained it is perfectly possible to have a system with many interacting objects which does not show a chaotic behaviour (for example, a rigid body represented as the continuous version of a large number of atoms strictly connected among them).

Starting from the idea that multi-variables systems could manifest chaos, we chose to introduce the double pendulum. They assembled it (the arms, the bolts and the nuts were on the table) fixing the long arm in the middle to have a symmetric and supposed stable situation. After some attempts, they realized that in order to have a evident chaotic behaviour, the best solution was to fix the arm using the first hole like in the picture.

They tried to predict the motion according to what they observed but after some oscillations they noted that it was impossible.

We teased them with a question: “Is there a connection between order and chaos?”. Their answer was “NO!” because they linked order with predictable events.

In order to contest this idea, we stimulated the students to use the equipment for convection. At first they kept thinking that it is mess to create chaotic motion. After a careful observation of the pigment motion in the water they learnt that without an organization of the water molecules the chaotic motion wouldn't exist.



We concluded our activity with the Sinai table to realize why it is impossible to predict the evolution of a chaotic motion.

We drew two paths on the table and we invited the students to play first without the disc on the middle and then with it. In the second case, they did many attempts to follow the paths unsuccessfully. In fact, they observed that, in the presence the disc in the middle, if the ball

hits the disc first, a very small change in the initial conditions “snowballed” and after just two rebounds the ball was clearly off the path. If the ball hits the table sides without to hit the disc, they didn't observe the effect (the balls can rebound only five or six times on our table).

At the end of the experiences, we have delivered to the students the following logbook

1. What have I studied?
 2. Which materials have I used?
 3. How did I do? (I'll have to be very detailed)
 4. What did it happen? What have I got?
 5. Why did it happen? Did I get the expected results?
 6. Have I conducted the experience alone or in a group? What did I do? What did the others do?
 7. Which part or moment did I like most?
 8. What would I change?
 9. Do I think that there is a connection with the life I live every day? In what?
- in order to understand if our goals had been achieved.

We triggered a brainstorming in order to capture possible evolution in the students understanding of the phenomena linked to the enveloped activities. For example, some students had found a possible source of chaos in the motion of the solar system planets when the interaction between all the planets and not only with the Sun is considered. Other students recognized the analogy between some images present in a slide we showed them during our presentation and a Lorenz attractor they saw during a visit to a science center. Also, other students linked the chaos (with particular attention to the dependence from initial time conditions) to the problem of the cars traffic in the morning when they go to school.

The reaction of students supported us on the efficacy of the path we have chosen because they linked the chaos theory with the concepts of non-linearity and linearity in physical systems and found other trackable examples in everyday life.

The experience with this class stimulated us to organize a well structured laboratory on physical systems manifesting non-linear and linear behaviour depending on initial conditions.

In our opinion, the basic concepts communicated through these experiences with students are observation, statistical uncertainties description and schematisation (models, prediction, interpretation), laws and theories from a physical point of view; from a mathematical point of view, instead, they are numbers, relations, functions (representations) and data (analysis and forecasting).

Finally, a topic like chaos has the advantage to have many connections with biology, chemistry and philosophy and to promote the development of many interdisciplinary activities.

Experiences vs workshop participants

We presented our idea on introducing nonlinear system starting from linear system at GIREP-MPTL 2014 International Conference. We chose the workshop modality to involve the participants in interactive and critic way. In the first part of the workshop we reported what are the didactic programs of Italian school and why we chose the items proposed. We continued presenting the activity done with students and exposing our idea on extending the educational experiences to laboratories spread in more time. In the second part, we involved the participants in the activity through the items. We recieved some suggestions in order to improve

and to enrich the laboratory. For example, in the perspective to extend the laboratory timetable including both the building of the items and the activities related to them, the possible challenges suggested by the workshop participants and expressed under form of engagement for students, are:

- Pull table: “How to reduce the friction of the ball with the table? And with the banks? How to hold the central body?”
- Double pendulum: “How to reduce the friction between the moving parts of the pendulum? How to highlight trajectories?”
- Convection: “How the convective motion of the fluid can be observed as detailed as possible?”
- Other possible engagements are:
- Pool table: “Try to throw a ball more than once in the same way”
- Double pendulum: “Try to let go the pendulum several times making it trace the same trajectory”
- Convection: “What effect temperature can have on convective motions? Do they depend heavily on temperature?”

Through this process, the students are involved in the resolution of problems rising from the building of items making them responsible for their learning. We think that this is resonant with the possibility to promote their competences and their significant learning.

4. Conclusions

In conclusion, in this paper we have shown three physical experiences whose dynamics, under certain conditions, are nonlinear. The experiments presented here are suitable to be used in a context of informal learning

We have engaged students in these experiences successfully and report it to workshop participants who suggested us how to improve our activities with interesting challenges.

Our idea is to include these items in a laboratory spread in more time where we would start from linear systems as for example oscillations of simple pendulum or coupled pendulums or fluid dynamics under laminar regime.

References

- Dolin, J., Evans, R., Quistgaard, N. (2009) “*Teaching and Learning Scientific Literacy and Citizenship in Partnership with Schools and Science Museums*” Department of Science Education, University of Copenhagen, in <http://www.museoscienza.org/setac/resources.asp>
- Work Package 3 Report: Guide for developing ESTABLISH, Teaching and Learning Units
- Shinbrot T., Grebogi C., Wisdom J., Yorke J. A., *Chaos in a double pendulum*, American Journal of Physics 60, 491 (1992)
- Ottimo J. *The mixing of fluids*, Scientific American, 260, 56-67 (1989)
- Crutchfield J. P., Packard N. H., Farmer, J. D., Shaw, R. S. *Chaos*, Scientific American 255, 46-57 (1986)

Affiliation and address information

Valeria Greco
 Associazione PALERMOSCIENZA, c.o. Consorzio ARCA
 Viale delle Scienze, ed.16
 90128 Palermo, PA, Italy
 e-mail: vgreco@palermoscienza.it

Salvatore Spagnolo
 Associazione PALERMOSCIENZA, c.o. Consorzio ARCA
 Viale delle Scienze, ed.16
 90128 Palermo, PA, Italy
 e-mail: spagnolo.salvo@gmail.com

Multimedia Software “Archimedes and his Work: a Deepening Path in the Arkimedeion Museum of Siracusa.

Silvia Merlino¹, Marco Bianucci¹, Carlo Mantovani¹, Roberto Fieschi²

¹ ISMAR-CNR, Forte Santa Teresa, Pozzuolo di Lerici, La Spezia, Italy

² Department of Physics, University of Parma, Viale delle Scienze 7/A, 43020 Parma, Italy

Abstract

The distinctive feature of the Arkimedeion, the modern interactive Museum located in Siracusa, Sicily (Italy) - which includes an exhibition of twenty-four interactive exhibits as well as a planetarium, is the "hands-on" approach, characteristic of modern international science centres, strictly based on interactivity between visitors and the proposed exhibits, for an active participation and a full intellectual involvement "minds on." (Bianucci et al. 2011a). Moreover, multimedia support material is especially designed to allow visitors to get a self explaining tour of the museum: general information about exhibits, historical news, mathematical demonstrations, and sources review are supplied by means of video and audiovisual interactive material, very rich in pictures, diagrams and animations, structured in different deepening levels. The multimedia software also provides visual examples, interactive models and virtual objects manipulation in a simple and very powerful way. Such material has been designed and implemented by a CNR team of physicists with expertise in science communication, in collaboration with some of the major Archimedes' experts around the world, especially from like Baltimore University, USA, and Pisa University, Italy. A special attention is given to interactive educational games.

Keywords

Scientific museum, science communication, teaching/learning strategies, educational games

1. Introduction

Mathematics and Physics are often abstract disciplines; thus we face some difficulties both in learning and teaching them. For that it turns really helpful to take advantage of the modern multimedia technologies (Fieschi et al. 2003, Bussei et al. 2007), including hardware exhibits, that are really effective to explain concepts through visual examples, models, real objects manipulation. Moreover new multimedia tools and modern exhibits allow us to try unexploited new teaching strategies. The “Arkimedeion” is an Interactive Science and Technology Museum dedicated to the many-sided genius Archimedes (287 B.C. – 212 B.C.) and to his work, and it is located in Siracusa, Italy (Bianucci et al. 2011b). A series of interactive exhibits, movies and multimedia software on touch screen kiosks, guide visitors into the middle of Archimedes' historical period and into the heart of his scientific work, making them discover and appreciate his great contribution to Science, and in particular to his work on mathematics and physics.

The principle that inspired the authors, beyond rigorousness and accuracy, was the need for a good educational and accessible approach. The museum contents and in particular the multimedia tools are structured in different levels of complexity, allowing multiple levels of approach by visitors, depending on their background. We attempted to expose part of the Archimedes' original documents in an easy-to-understand way with the help of modern tools in order to facilitate the understanding of complex mathematical demonstrations.

For this purpose, a special role is devoted to the mathematical and physical interactive games, considered as educational spaces of play-learning (Merlino et al. 2003), and based on the many scientific discoveries and demonstrations of Archimedes (Arkimedeion's interactive laboratory and the Stomakion tool). Archimedes was, in fact, also one of the earliest known brain-teaser enthusiasts, among which we mention: the Archimedes' cattle problem (or the *problema bovinum*); the investigation about the number of grains of sand that the universe could contain, opportunity to introduce a system of counting based on the myriad that anticipated our numeral positional system and the exponential notation; the Stomachion, a dissection puzzle made of 14 pieces originally forming a square, presented in the Museum both as exhibit and educational videogame.

We are aware that the playful moments stimulate the ability to abstract (Bondioli 2002, Gee 2007), and provides an opportunity of de-contextualization compared to schoolwork, (Green and MacNeese 2007, Green and MacNeese 2011), activating then personal learning processes (Michellini et.al 2008); in this way the game can become an important opportunity for learning (Bateson 2002, Gee 2003)

2. Scientific path, exhibits and structure of multimedia

After an introductory presentation, focused on the discovery of the Palimpsest and on the importance of this event (including interviews with famous historians and researchers), visitors follow a scientific path organized in four macro-areas: Machines for Society, Equilibrium, Mathematics and Planetarium. Each area is equipped with several touch-screen kiosks showing the multimedia contents related to this area. Multimedia are structured with different levels of detail and are based on animation of graphical and textual elements helping to develop and illustrate concepts often abstract and not very intuitive. Each macro-area is organized in few *themes*. In fig.1 and 2 we only show some examples, as the theme *Give me the place to stand*, in the *equilibrium* macro-area.

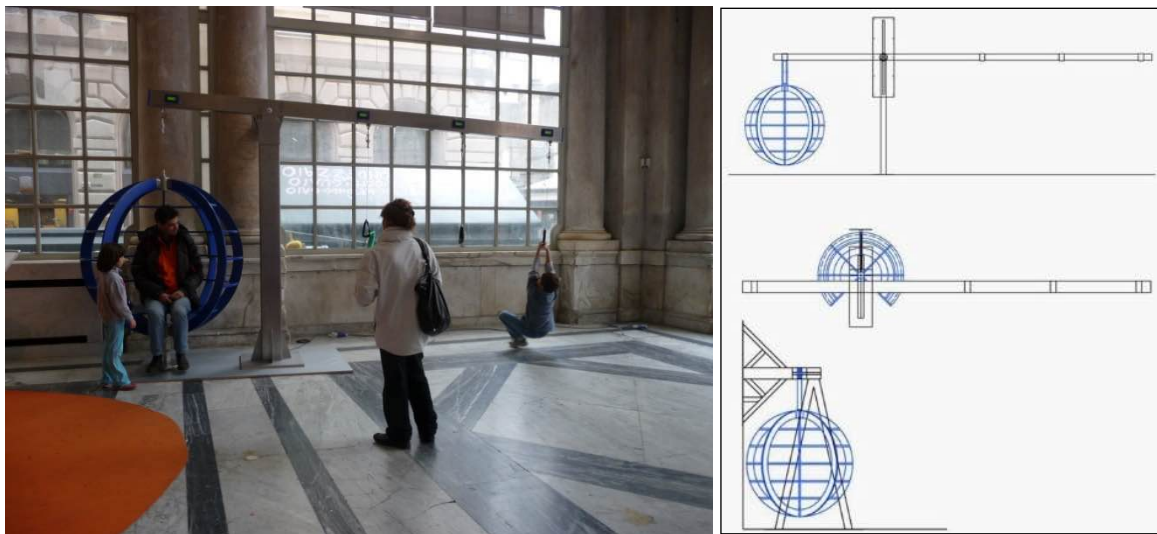

Figure 1. Using a large lever the visitor can raise, with a little effort, a person sitting in the building that reproduces the shape of the Earth; in this way we realize the famous Archimedes' quote: "Give me the place to stand and I shall move the Earth"

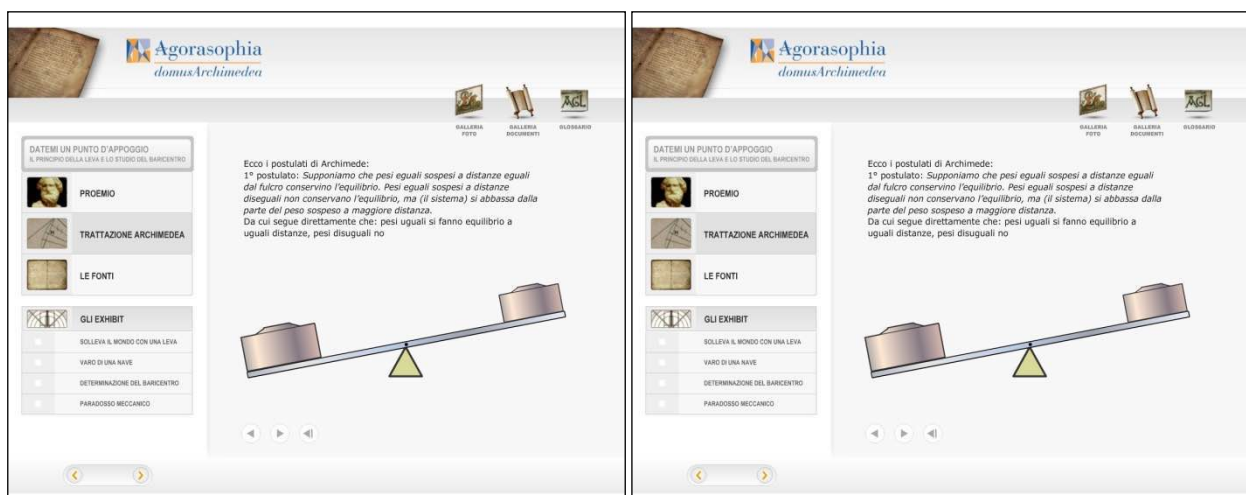

Figure 2. A sequence of two screenshots from the theme "Give me the place to stand": it illustrates the visual approach to mathematical demonstrations through animations related to the exhibit in fig.1

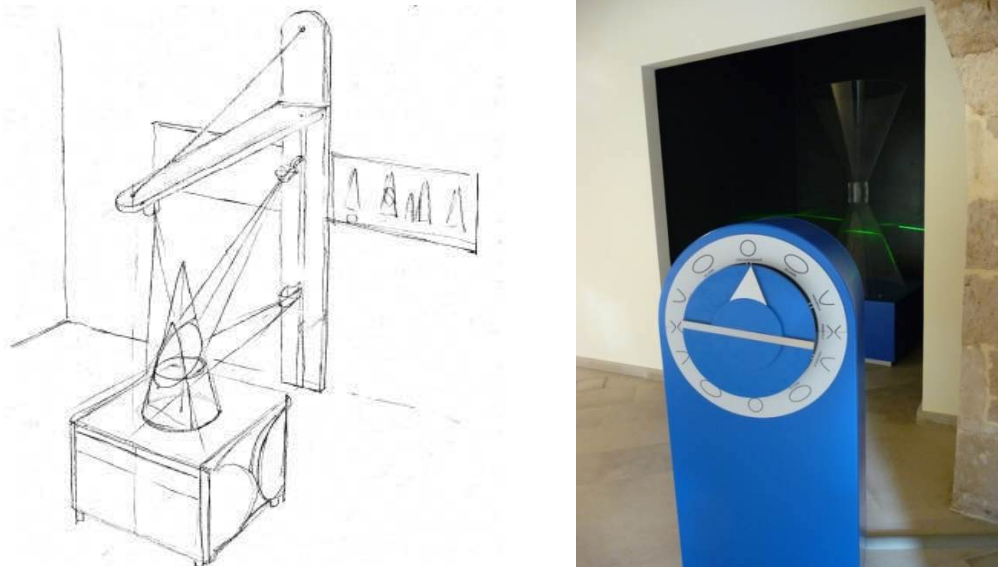

Figure 3. Another theme is the “geometry of position: the plane curves and the solids of revolution”. One of the exhibits is composed by a big cone of Plexiglas and by a structure mounted on the wall (see Fig. 3). The structure holds up four steerable laser projectors that generate plans of light. Every time one plane intersects the cone it produces a conic section. It is possible to show four different conic sections at the same time: ellipse, circle, parabola and hyperbola. Here the draft (on the left) and the exhibit (on the right).

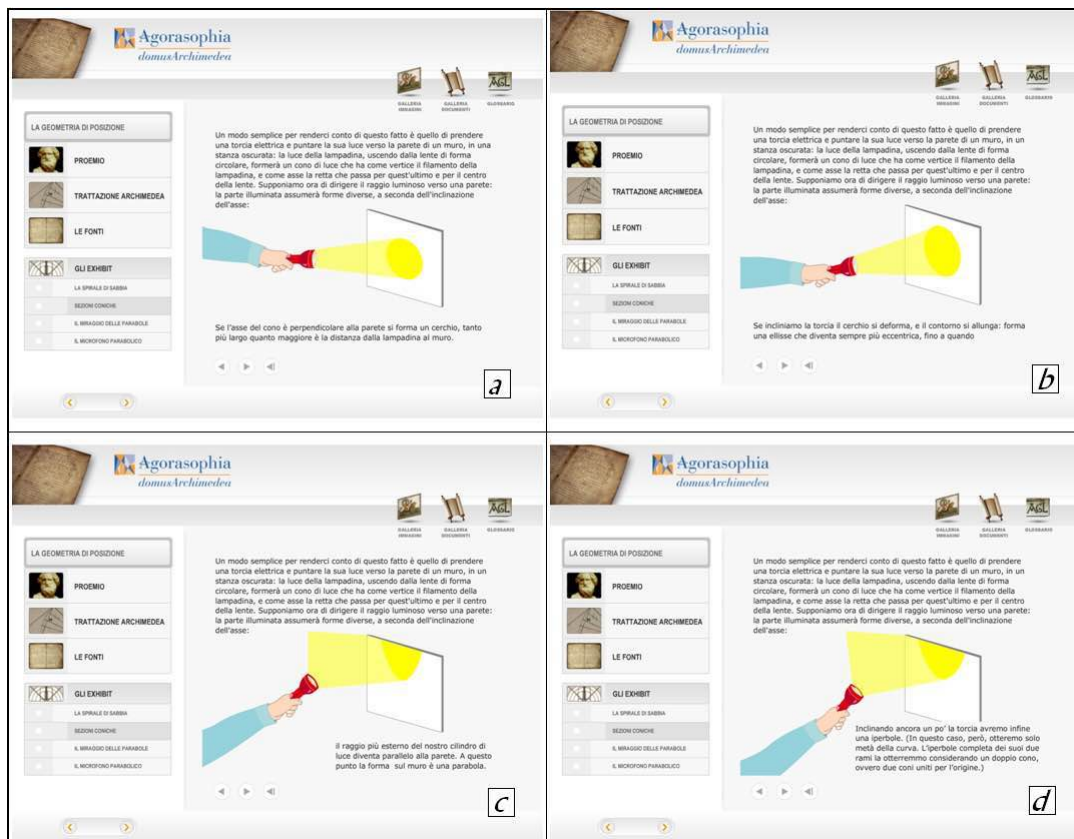

Figure 4. Screenshots of the animation used to visualize conic sections in an amusing and intuitive way. The multimedia support of the theme “geometry of position: the plane curves and the solids of revolution” deepens the concept of conic section and its importance in the history of Greek mathematics. It also discusses the various methods used to obtain the four plane figures (ellipse, circle, parabola and hyperbole) and the connections with the physical phenomena, such as orbits of planets and asteroids.

3. The Arkimedeion Virtual Laboratory.

The Archimedes' Lab is an educational computer game intended for people of all ages and backgrounds. It's inspired by other famous games like the *Incredible Machine* computer game series (Jeff Tunnell - PushButton Labs), and many other 2D platform-like computer games where the player must arrange a given collection of objects in a needlessly complex fashion so as to perform some simple task. In our case the task is to allow a ball moving in a vertical board to reach a given target. The ball is affected by gravity, there are many obstacles disseminated on the board, and there are a lot of tools that can be used to avoid/destroy the obstacles and to route the ball along the right path.

Archimedes' Lab is designed, like most of the computer games, with an increasing level of difficulty. Moreover, being an educational game, it is also calibrated to allow users to gradually improve their knowledge, in this case about the physical principles and results related to the Archimedes work.

In fact, the interacting objects on the game's stage are strictly linked with the Archimedes opera, as they are levers, parabolic mirrors, solids of revolution, catapults, etc., and they behave following physical laws, although in a simplified way because represented in a 2D cartoon-style world. It means, for instance, that the player can balance a lever attaching different solids of revolution to the edge of the lever, however this must be done according to the proportions between such solids' volume, as found by Archimedes. In general all the objects must be combined and placed in the correct position in the stage so that, when the player starts the simulation, they can allow the ball to reach the target. In the most advanced levels additional elements are added, e.g. the levers can be located underwater, involving in such way also the *Archimedes' principle* about buoyancy.

The design of the Lab was mainly focused on developing a game easy to use, entertaining, and at the same time able to force the player to manipulate and apply concepts related to the work of Archimedes. *Application* of the physical concepts described in the game and in the museum, and immediate *feedback* in the result of the game, make players to understand connections of the theory with the real world. By learning from their mistakes, players improve their ability to solve game situations.

Moreover, in each level the path leading the ball to the goal is not unique, so that the tools to use, and the actions to be performed, are not bounded: the player moves in a playing environment with many degrees of freedom. This fact gives the chance to solve the same game level using different strategies, more or less efficient, contributing to a personalized learning of concepts.

The Virtual Lab can also work as a game levels editor, promoting the user from a simple player to a game's level designer, i.e. giving the possibility to realize a customized versions of the game.

This editing mode not only stimulates and reinforces the learning of concepts related to the Archimedes' work, but also encourage personal manipulation of concepts, fantasy, improvement on game strategy and consequently on problem solving ability.

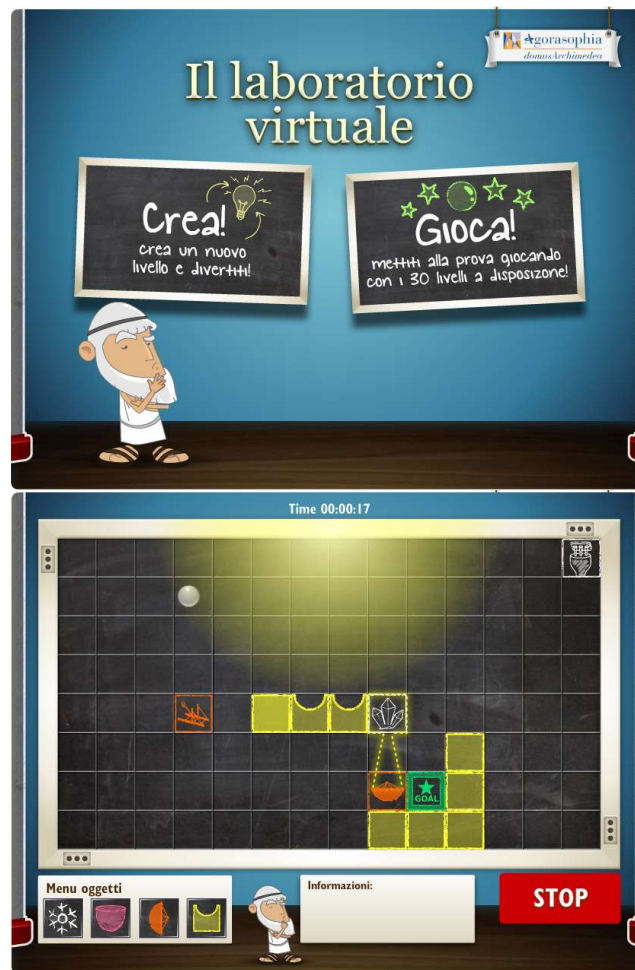

Figure 5. Screenshots of the virtual Lab. This Lab is designed as a modern app, with a good playability and with an original cartoon-style “drag and drop” GUI (graphical user interface). On the left we can see the menu where it is possible to enter the “Level Editor” mode.

4. Teaching and learning use of Archimedes’ lab and related pedagogical

Archimedes’ Lab has been designed in order to improve the science museum visiting experience, but it also represents an useful educational tool for teaching and learning physics:

- in a museum context, it can be used both as a recreational game without educational purposes, and for consolidating or assessing the learning of concepts related to the Archimedes’ work. Obviously, in the latter case it is desirable to browse through the entire Archimedes’ multimedia before trying this game.
- as teaching/learning tool, it can be used in the classroom to introduce or deepen knowledge in the field of physics, such as the balance of forces, the laws of motion and gravity, buoyancy, and also the principles of geometrical optics.

The question of how knowledge acquired during the game can be transferred into the real world reveals the Achilles’ heel of digital gaming. We think that in our case the main limitation is the simplification of the simulation: needless to say, physical laws used in the game are approximation of the real ones (for example, friction is not included in the simulation).

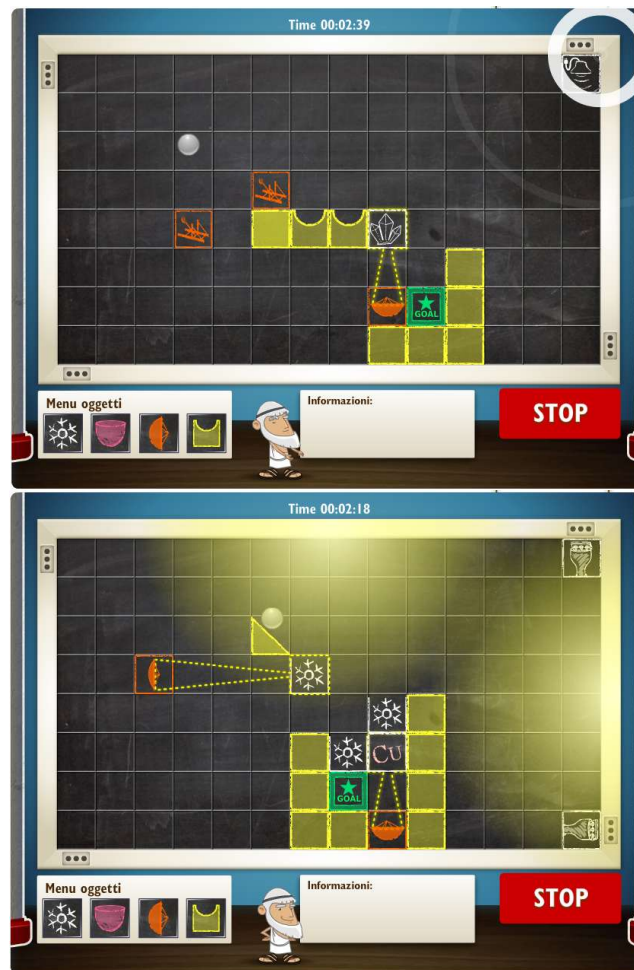

Figure 6. Screenshots of the virtual Lab. Using in a proper way some mirrors to focus sound waves (left) or light waves (right), and catapults, the player should find the way to build a path for the ball to reach the goal.

Simplifications and schematic representations of reality could also lead the player to miss the link between the game solving strategy and the concepts about Archimedes' work we would like him to learn through the game. In other words, a student could become very able in solving the game levels, but then he could still find difficulties in solving simple problems of statics in the classroom.



Figure 7. Other screenshots of the virtual Lab where the player can place, move and set mirrors and catapults to build the right path for the ball.

The pedagogical question here is to determine in which real context players can apply what they have learnt and which aspects can be transferred directly from the game.

A process of de-contextualization is required, in order to create correlation between learning accomplishments in play and those in the real-life context. Once players/students have been made aware of the relevant content and their learning accomplishments, a link between the virtual and the real domain must be created. Here is where the importance of the teacher's role is, when games are used – something that is underestimated to this day –. The learners require constructive support to identify and consider, in the settings of the game, any aspect relevant to their learning process. External impetus is therefore needed to direct attention to the potential of the games and to what has been learnt in them (Thai et al. 2009). This is a meta perspective that teachers can and should adopt in order to foster the educational potential of games. If teachers are able to create a link between the virtual and the real context, their action may make a transfer possible. This educational role demands that teachers be interested and willing to engage with educational games (Klopfer et al. 2009). Being aware of this, using games like the virtual Lab as didactic tools, can be well worthwhile, becoming a new learning challenge for teachers.



Figure 8. Here the player should use some knowledge regarding the laws of the lever and the ratio between the volumes of different solids of revolution.

5. Stomachion game: the exhibit and the computer game

Every game begins with a *challenge* that motivates the players to put their knowledge and skills to the test. The challenge of the game allows players to fail in an enjoyable way while encouraging them to learn and improve.

The players find out whether their abilities are sufficient to meet the requirements. Their own progress in the game gives them the reassurance of having achieved and learnt something. In this sense, the game “Stomachion”, represent a *mathematical challenge*.

Stomachion was an ancient game widespread in Greece and Rome (Napolitani 2001), and basically consists on a 14-piece dissection puzzle where the pieces are polygons that can be reassembled to form different

shapes (geometrical shapes but also animals, trees, etc.). But the biggest challenge is to arrange them in different ways to form a square. The game is attributed to Archimedes, as one of its most complete descriptions was found in the Archimedes' Palimpsest ¹. A research published by Dr. Reviel Netz of Stanford University and his co-workers (Netz et al. 2004) argued that actually Archimedes was attempting to determine in how many ways the pieces could be assembled into the shape of a square. Therefore the puzzle could represent an early problem in combinatorics, even if the ancient authors exclude the use of combinatorial analysis in the Archimedes' treatise (Napolitani 2001). An interesting point is that Archimedes was able to calculate the area of each polygon of the Stomachion.

The exhibit

In the Arkimedeion Museum, Stomachion is proposed both as interactive computer game and as interactive exhibit; this last is a big 14-piece dissection puzzle made of wood. Visitors can manipulate pieces and place them on a table to form classical shapes. These represent the first and simple level of the game, and it is particularly useful for young students. In fact, here children can test their ability to solve puzzles, and understand some important geometrical properties of polygons. For mathematics enthusiasts and more expert in mathematics, it is possible to go a little more in depth, analyzing the case of the square and trying to form it with different arrangements ². In any case, to help visitors not familiar with the game, a touch-screen monitor installed on the exhibit shows instructions and suggestions on request, as a "tutorial".

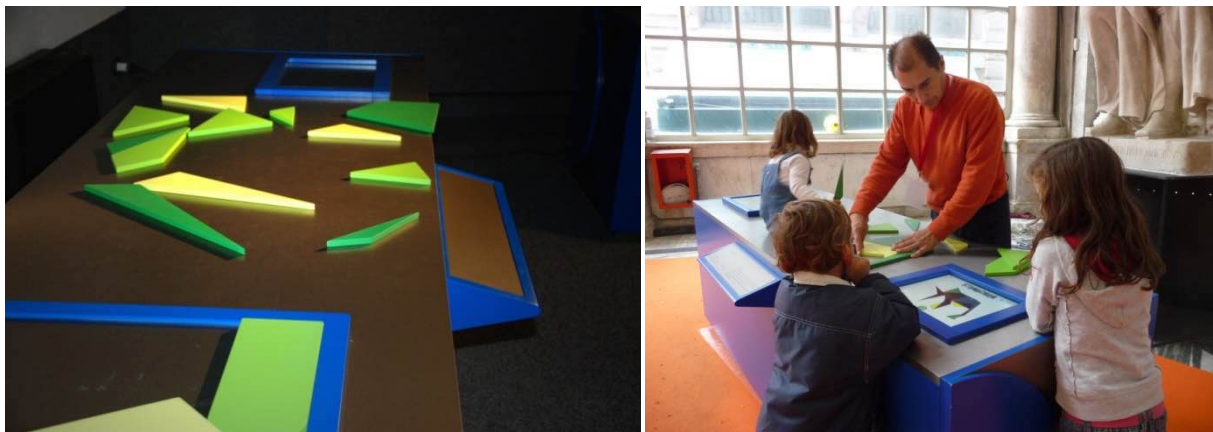

Figure 9. The Stomachion exhibit. This wood game is especially studied to result appealing for children and young students. The first level approach is easy and, at the same time, instructive, and can be used to discover some important geometrical properties of polygons.

¹ The foremost document containing the work of Archimedes is the Archimedes Palimpsest, discovered in 1906 in Constantinople (Istanbul) by the Danish professor Johan Ludvig Heiberg. The palimpsest is now stored at the Walters Art Museum in Baltimore, Maryland, where it has been subjected to a range of modern tests including the use of ultraviolet and x-ray light to read the overwritten.

² Actually, the most interesting aspect of the Stomachion – the real “mathematical challenge” - is to determine in how many ways the pieces can be assembled to form a square. This brainteaser was solved first in 2003 by Bill Cutler. He demonstrated, with the aid of a computer, that there are 536 possible independent arrangements. It means that solutions obtained by rotation and/or reflection of another given solution are not considered in this number.

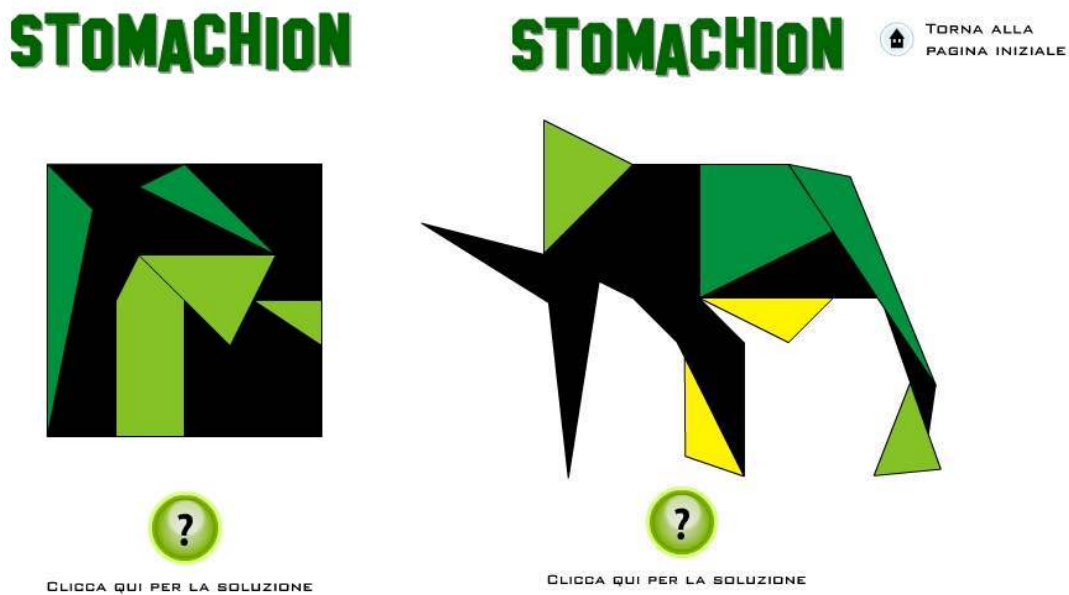

Figure 10. The “tutorial” assists visitors in the use of the wood exhibit “Stomachion”. On the right, one of the different shapes that can be realized using the all pieces. On the left, one of the 536 dispositions of pieces to form a square.

The computer game

In Stomachion brain-teaser there are 536 possible independent ways to arrange polygons to form a square, and it could be interesting to see all of them, or better to give the possibility to find them interactively. For this purpose an interactive computer game has been developed. It can identify and enumerate each solution of the puzzle, and, when a solution is found, a counter shows the number of the remaining arrangements. Another important feature of the game is the capability to check partial arrangements and to show which polygon is in the right place and which is not and, on request, to provide suggestions on the following piece and its correct position.

A scoring system is under development. We consider it a very important part of the game, as it pushes users to avoid asking for help and suggestions, therefore to think better and faster, and finally to improve the understanding of many mathematical and geometrical issues.

The game is developed with Adobe Flash technology. This fact ensures compatibility with many platforms and devices and allows its distribution online to entertain and engage gamers all over the world, increasing the Archimedes’ worldwide reputation.

Archimedes is, undoubtedly, one of the greatest mathematical geniuses ever. It must be realized, however, that the distinction between the different categories of scientists, based on the current classification of scientific disciplines, is not applicable to ancient scientists like Archimedes. Thus, when we say that Archimedes was a great mathematician, this is because today we include in mathematics much of his work. But such precinct is actually too limiting as Archimedes applied his formal and logical deductive methodologies both to quite abstract mathematical issues and to problems we today consider belonging to the field of physics, such as the laws of the lever, the buoyancy, the study of the equilibrium of the bodies (statics). The countless contributions he gave to the development of what we now call the physical sciences are based on mathematical considerations, often geometric (algebra had not been formalized yet). The original opera of Archimedes is hard to understand for modern readers because of formalism, language, key “primitive” assumptions and the logical construction used to expose its results. They are objectively a tremendous obstacle for reading and understanding the work of this great genius. That's why we believe that our work of "adaptation", using a modern formalism and a multimedia interactive presentation, can be really effective in introducing the user (museum visitor or student) to Archimedes and in disseminating the results of the work of this great scientist, unfortunately well known most of the time for the famous *Archimedes' principle of buoyancy*, and not for the many other contributions he gave to the modern science.

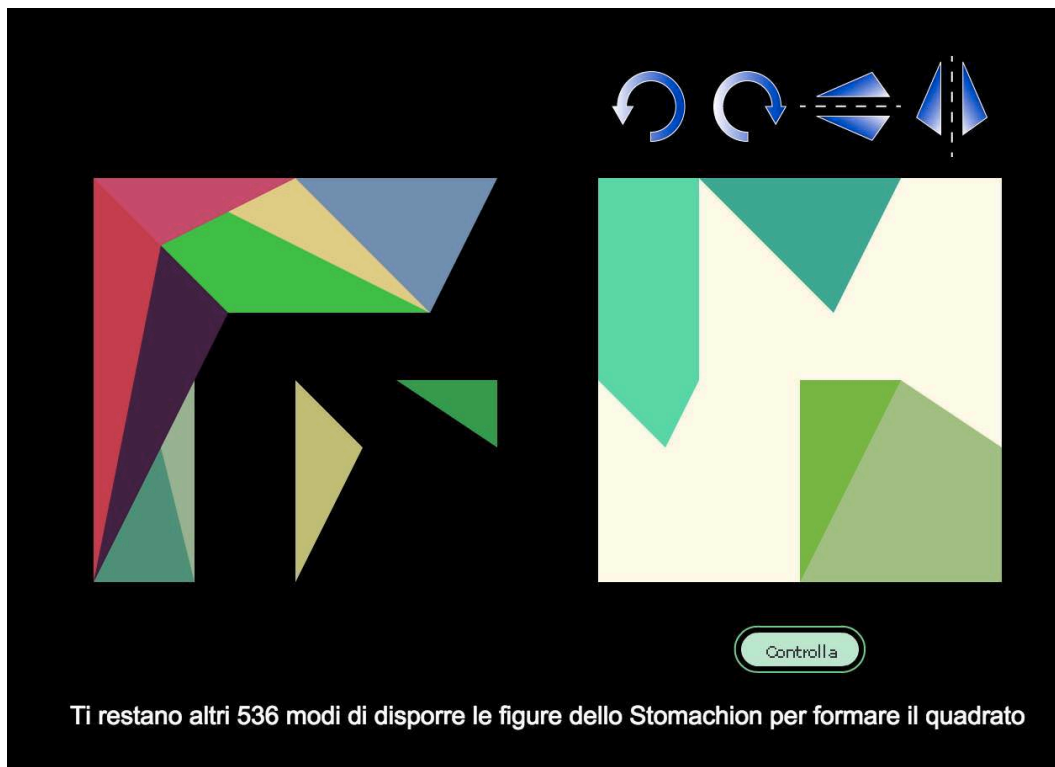

Figure 11. Screenshots from the Stomachion computer game.

Acknowledgment

Infmedia Company, the Italian software house that developed multimedia software in cooperation with the Informando team of CNR; Luca Busi Video recording studio “Zero-frame” for the introductory video. Weisstein, Eric W. “Stomachion.” From MathWorld--A Wolfram Web Resource. <http://mathworld.wolfram.com/Stomachion.html>

References

- Bateson G. (2002). *Mind and Nature. A Necessary Unity*, Hampton Press and Institute for Intercultural Studies, Cresskill - NJ.
- Bianucci, M., Fieschi, R., Mantovani, C., and Merlino, S. (2011a) “Promoting and teaching “hard” science in an amusing way: the “Domus Archimedeae” approach to Greek mathematics”, (ICBL 2011), Antigua Guatemala, 2-4 Novembre 2011. Published by Kassel University Press (2011). ISBN of Collection: 978-3-89958-556-8
- Bianucci M., Fieschi R. and Merlino S (2011b). *The Museum of Archimedes, The key to the thinking of Archimedes*, Ed Itinera Thesauron, pp 6.
- Bondioli A. (2002). *Il tempo nella quotidianità infantile*, Edizioni Junior, Bergamo
- Bussei P., Bianucci M., Fieschi R., Gambarelli L., Mantovani C., Merlino S. (2007). “WESPA, a multilingual European Project for teaching Energy and Semiconductors concepts using interactive approaches”, *Journal of Materials Educations*, 29 (3-4), 233.
- Cutler, B. (2003). *The Loculus of Archimedes, solved*, Ed Pegg Jr.
- Fieschi R., Bianucci M. and Merlino S., (2003). Teaching and popularising physics by multimedia instruments: INFm experiences AND ACTIONS. *Proceeding of GIREP (Gruppo Internazionale di Ricerca sull’Insegnamento della Fisica): “Quality development in teacher education and training”*, Udine, 1-6 Settembre 2003;
- Gee J.P. (2003). *What video games have to teach us about learning and literacy*. New York: Palgrave.

- Gee J.P. (2007). Video games, learning and “content”. *Harvard Interactive Media Review*, 1(1), 24-29
- Green, M. E and McNeese, M.N. (2007). Using edutainment software to enhance online learning, *International Journal on E-Learning*, 6(1), 5-16
- Green, M.E. and McNeese M.N (2011). Using digital games and virtual environments to enhance learning. pp 79-105. In: *Learning to play. Exploring the Future of Education with Video games*, Ed. Myint Swe Khine Collana “New literacies and digital epistemologies, V 53), ISSN 1523-9543, Peter Lang Publishing, Inc., New York. 2011
- Klopfer, E., Osterweil, S., Groff, J., and Haas, J. (2009). The instructional power of digital games social networking: simulation and how teachers can leverage them. , from *The Educational Arcade*, <http://www.educationalarcade.org/>,
- Merlino S., Roberto Fieschi R., Bianucci M. and Davies B. “EPS becomes partner in exciting European education project”; *Europhysics New* 33/2 2002, March/April.
- Michelini M., Santi L., Stefanel A., Mossenta A., Viola R., Colombo M. (2008). Educazione informale e giochi nelle ricerche sull’apprendimento. <http://www.fisica.uniud.it/URDF/articoli/ftp/2008/2008-32.pdf>
- Morelli G. (2009). Lo stomachion di Archimede nelle testimonianze antiche, *Bollettino di storia delle scienze matematiche* **14 (2)**.
- Napolitani P.D., (2001). "Archimede", *Collana “I grandi della scienza”*, Le Scienze, Italia,
- Netz F., Acerbi F. and Wilson N., (2004). Towards a Reconstruction of Archimedes’ Stomachion, *Sciamus*, 5, pp.67-99.
- Thai, A., Lowenstein, D., Ching, D., Rejeski, D. (2009). Game changer: Investing in digital play to advance children’s learning and health. New York: The Joan Ganzá Cooney Center at Sesame Workshop

Affiliation and address information

Silvia Merlino
ISMAR-CNR, U.O.S. La Spezia,
Forte Santa Teresa,
Pozzuolo di Lerici,
19038 La Spezia.SP, Italy
e-mail: silvia.merlino@sp.ismar.cnr.it

Physics Competitions for Learners of Primary Schools in Slovenia

Barbara Rovšek¹, Robert Repnik²

¹ *Faculty of Education, University of Ljubljana, Slovenia, and DMFA Slovenije.*

² *Faculty of Natural Sciences and Mathematics, University of Maribor, Slovenia.*

Abstract

We are going to present our experiences with physics competitions for young learners in Slovene primary schools. We will describe our 3-level organizational format of competitions. At the last, national level, competitors have to solve theoretical and experimental problems. We will give reasons for having and keeping the experimental part at the last level; we will show examples of results and comment achievements of learners at experimental vs. theoretical part and show also frequency of physics topics, having a role in experimental problems in competition. An example of experimental problem at competition will be given.

Keywords

Physics competitions, experimental problems, IBSL

1. Brief history and format of physics competitions

Physics became a primary school subject in Slovenia even before the major educational reform in 1958, when obligatory 8-years (in 1996 changed to obligatory 9-years) primary school was introduced. Learners of ages 13 and 14 are taught physics in the last two grades (8th and 9th) of primary school since then. The same holds for chemistry and biology, as the other two science discipline subjects. More than 95% of primary schools in Slovenia are public schools and are obliged to follow the same curriculum.

In 1981 the first national competition in physics for learners of primary schools took place and in the school year 2013/2014 Slovene Association of Mathematicians, Physicists and Astronomers (DMFA Slovenije, in ref.), with substantial help from Universities of Ljubljana and Maribor and also teachers from all participating primary schools organized 34. competition already. Only mathematics competitions have longer tradition among all competitions in school subjects in Slovenia.

Since its beginning the format of the competition gradually evolved and in the present it is a three-level competition, starting with the first, school level, followed by the second, regional, and completed by the last, national level. In the last decade approximately stable one quarter of generation participates in the physics competition, which amounts to approximately 9000 learners participating altogether each year. Competitors literally come from almost all Slovene primary schools. Competition being completely voluntary for learners we consider this proportion of learners showing enough interest for physics to put some additional efforts and invest some spare time into preparations, satisfactory. We understand it is a result of united efforts not only of the learners themselves, but also of their teachers, acting as their mentors and also as more or less voluntary organizers of school and regional stages of the competition, and finally, members of national competition committee, who are the authors of physics problems on all three levels of the competition.

The number of competitors at the 2nd, regional stage is around 1700, which means that every fifth participant of the school level competition enters the next level. We have 300 competitors at the last, national level: from 30 competitors at the school level one of them enters the last level.

Questions and problems for all levels of competition are developed by the same team; national competition committee, more or less voluntary group of 5-7 enthusiastic members. Solutions and marking schemes are produced by the same team. The school level competition is organized in all primary schools at the same time by physics teachers, teaching at those schools. According to the given marking scheme the teachers themselves evaluate the papers of their pupils and also submit their results to the internet server. In few weeks the next, regional level of competition is organized (in the last few years in 17 regions) in corresponding number of voluntary primary schools. Again teachers gather to mark the papers of competitors and submit their results. The last level of competition is organized at Faculty of Education in Ljubljana (for central Slovenia), at Faculty of Natural Sciences and Mathematics in Maribor (for eastern parts), and at one primary school (for western parts).

2. Questions and problems at physics competitions

Problems, which are to be solved at the first two levels of competition, are theoretical. There are some multiple choice questions (around 5) and few open problems (2 or 3). In accordance with the nature of physics, being experimental science discipline, the last stage of the competition consists of two parts: theoretical and experimental. Each part lasts for 90 minutes (changed to 80 minutes in the last year). Physics competitions are, expressing appreciation for experimental part, rather unique among other existing science (and mathematics) competitions. Before the last school year competitors had to solve two shorter and simpler experimental problems and from the last school year they were changed for one, more complex experiment. Due to this organizational change also the rationale of experimental problems changed a little, taking into account the new timing and to ensure the optimal (normal) distribution of performance in solving the problems.

We think it is important to keep the experimental part of the competition for several reasons. One was mentioned above; physics is also experimental discipline. It is good to have a balance between theory and experiment also in competition, to demonstrate they are both important. Experiments can also have motivational potential for many pupils, who like to experiment. At last, with theory and experiment each competitor has a possibility to express his or her stronger side; some are more theoreticians, others are better skilled experimentalists. We have a balance again.

The evidence is shown in Table 1, where as an example, a distribution of 299 competitors at the national level of competition in 2013/2014 according to their results in theoretical vs. experimental part is presented. We have divided competitors twice into 5 success categories: into 5 success categories from Th-1 to Th-5 for results from theoretical problems and 5 success categories from Ex-1 to Ex-5 for results of experimental problem. In every category we have approximately the same number of competitors (1/5 of all, who have achieved approximately the same result and are therefore in the same category). In groups Th-1 (Ex-1) there are those with the lowest results in theoretical (experimental) part and in groups Th-5 (Ex-5) there are those with the best results in theoretical (experimental) part. Among all 299 participant 109 were awarded. How the awarded competitors are distributed in success categories is presented in Table 1 with numbers in parenthesis.

Table 1. Cross table is showing distribution of all 299 competitors at the national level into different theoretical (Th) and experimental (Ex) success categories, for the school year 2013/2014.

		better <i>theoreticians</i> →					
		Th-1	Th-2	Th-3	Th-4	Th-5	Σ
better experimentalists ↓	Ex-1	17	17	14	10 (1)	3 (3)	61
	Ex-2	16	10	12	7	6 (2)	51
	Ex-3	12	14 (1)	17 (3)	13 (6)	10 (10)	66
	Ex-4	1	11	9 (3)	12 (8)	14 (13)	47
	Ex-5	6	11 (5)	12 (9)	17 (17)	28 (28)	74
Σ		52	63	64	59	61	299

From Table 1 we see that there are pupils who possess universal abilities and skills and do well at theoretical and experimental problems. But there are also some, who performed experiments very well and were rather weak at theoretical part, or just the opposite, but are still good enough on the average and therefore earn the award. For example, those 5 in the cross-section of categories Th-2 and Ex-5 or those 3 + 2 in cross-section of Th-5 and Ex-1 and Ex-2. There are also some virtual anomalies present in the table, which originate from the cross-sections of categories at their edges.

3. Topics at experimental problems

Syllabus for physics competitions to a large extent corresponds to the physics core curriculum, obligatory for all. Even if the curriculum does not prescribe how the topics should be taught in sequence, there are topics, which are traditionally taught during the lessons in the beginning of the school year, and other topics

naturally follow. National level of competition takes place in the spring, near the end (but not at the end) of the school year. By that time all but the last topics are taught. Traditionally, the last content in the last grade of primary school is magnetism. Therefore we never have had an experimental problem in magnetism. Table 2 shows which topics and how often they appeared in experimental problems at national level of competition in the last 22 years. There were 86 experimental problems altogether. In the last column of the table there are some supports or obstacles mentioned, which influence the frequency of using certain topic at experimental problem.

Table 2. Topics, which appear in experimental problems at national level of physics competition in the last 22 years, the frequency N of their appearing and possible reasons, influencing the frequency.

Topic	N	Pros and contras
Density, hydrostatic pressure, buoyancy	2 5	<ul style="list-style-type: none"> • Important topics (with plenty of time allocated for them in curriculum), • many variations possible (what and how to measure), • simple, not expensive equipment, • can be performed in a short time.
Electric circuits	2 2	<ul style="list-style-type: none"> • Important topics, • many variations possible, • can be performed in a short time.
Simple measurements, kinematics	7	<ul style="list-style-type: none"> • Spatially demanding, • difficult to perform sitting behind a desk.
Light (geometrical optics)	6	<ul style="list-style-type: none"> • Darkness in the classroom/lab, • disturbing light sources of others.
Forces (also Hook's law)	1 0	<ul style="list-style-type: none"> • Quite popular, but have exhausted many variations.
Newton's 2 nd law of motion	5	<ul style="list-style-type: none"> • Spatially demanding, • difficult to perform sitting behind a desk.
Work and energy	7	<ul style="list-style-type: none"> • Spatially demanding, • difficult to perform sitting behind a desk.
Heat and internal energy	2	(g) Difficult to arrange equipment, (h) time consuming.

Some topics are evergreens; they appeared at competitions literally every year. On the other hand, there are few topics coming rarely to the schedule, for variety of reasons some of which are mentioned in the last column of Table 2. The most obvious are time and space limitations. There is another important theme never used in experimental problem in competition, but supported by curriculum: astronomy. We have approximately 300 competitors in the experimental part; we did not think of appropriate astronomical experimental problem yet which could be solved by so many learners at the same time with spatial, time and other organizational limitations put upon us.

As was already mentioned, in the last run of competition we have reformed the format of competition; two shorter experimental problems were substituted by one longer problem. There are few reasons for introducing one extensive experiment in 80 minutes instead of two more simple experiments in 2-times 45 minutes. We are able to introduce more complex experimental problem, which would be impossible to perform in 45 minutes. Partially new topic can be introduced with some explanation in the beginning. Also, some tasks can be easier; on lower taxonomy level, and there is still time for more advanced tasks at the end. At last but not least, there is enough time to repeat some part of experiment, if needed.

We think of the experimental problem given at competition as an example of guided IBSL problem. Learners need to carefully read the instructions, possess basic skills to perform simple measurements, be familiar with presentations of results of measurements, and be able to analyze, synthesize and use their findings in new examples. In each experimental problem there can be parts where reasoning goes from general to specific or/and from specific to general. We somehow managed to include tasks at different taxonomy levels

(Anderson and Krathwohl) already in the short 45-minutes experimental problems, as shown with an example in Appendix, and the aim is even more easily achieved with 80-minutes experimental problems. We conclude this short presentation of our practice and experiences with an example of results, showing how successful competitors have been at performing and solving the 45-minutes experimental problems in national level of competition in the school year 2010/2011. There were four different experiments given, two to 8th graders (E1-8 and E2-8; one of them is given in Appendix) and two to 9th graders (E1-9 and E2-9). Total number of points for each problem was 10. A distribution of competitors according to the total number of points they have earned at particular experimental problem is shown in Figure 1 and averages of their points in Table 3.

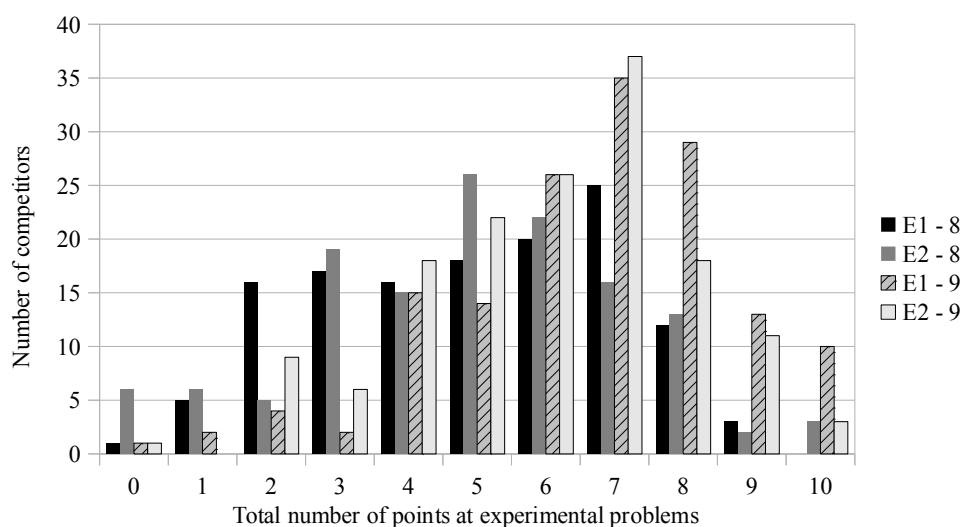

Figure 1. Distribution of competitors (133 in 8th grade and 151 in 9th grade) according to the total number of points (out of maximum 10) they have earned at each experimental problem (E1 and E2) at competition in the school year 2010/2011.

Table 3. Average points obtained at experimental problems in competition in the school year 2010/2011.

Experimental problem	Average points
E1 – 8	4.96 ± 2.14
E2 – 8	4.95 ± 2.28
E1 – 9	6.60 ± 2.02
E2 – 9	6.60 ± 1.97

One can grasp immediately that 9th graders were more successful at performing their experiments, due mostly to not completely balanced difficulties of problems. Obtaining such distributions of points with appropriate resolution at the high end also at theoretical problems we were completely able to identify the winners, with acceptable – very small – measurement error. We can be pretty much certain that the prizes went into the right hands.

4. Conclusions

We have presented the contemporary format of physics competitions for learners of primary schools in Slovenia. In spite of long tradition we never consider the format as final; on the contrary, we moderately experiment with the format itself and search for possible improvements or adaptations to new circumstances (for example, changing curriculum). However we consider some attributes of competition as firm and constant; among these the most important are the 3-level system of competition and inclusion of experimental part in the last level of competition. We have arguments to stay steady about these issues.

References

Anderson, L. W. and Krathwohl, D. R., et al. (Eds.) (2001). *A Taxonomy for Learning, Teaching, and Assessing: A Revision of Bloom's Taxonomy of Educational Objectives*. Allyn & Bacon. Boston, MA (Pearson Education Group).

Association of Mathematicians, Physicists and astronomers of Slovenia, web page of primary school physics competitions committee, http://www.dmfa.si/fiz_OS/index.html

Affiliation and address information

Barbara Rovšek
Faculty of Education, University of Ljubljana
Kardeljeva ploščad 16
1000 Ljubljana, Slovenia
e-mail: barbara.rovsek@pef.uni-lj.si

A Singing Wine Glass as an Instrument for Teaching Acoustics.

**José Antonio Zárate Colín, Marisol, Rodríguez Arcos, Karina Ramos
Musalem, Estela Margarita Puente Leos, Marcos Ley Koo**
Facultad de Ciencias, Universidad Nacional Autónoma de México.

Abstract

In this paper, we present the work done by a group of three undergraduate students majoring in physics during their leisure time, in order to study the singing wine glass phenomenon. Here we describe the tests performed to identify variables, and their measurement, that were used in the experimental analysis. Although this is a simple experiment, considering it for teaching sound waves can be a very illustrative experience.

Keywords

Laboratory activities. Informal physics teaching and learning. Wine glasses singing. Sound waves.

1. Teaching method proposal

Throughout its history, physics has been based on experimental research. Thus, experimental physics education is essential for a complete training of students majoring in physics, regardless of their theoretical or as experimental interest.

Unfortunately, in México, most of the experimental physics courses at all educational levels, follow very strict traditional formats, where the students initiative is of no concern; just guided by the teacher, students construct their knowledge mechanically. Most of the times, courses have the tendency to make students follow a series of instructions, as a recipe, which include the list of material and equipment, the procedure, step by step, and even the results and conclusions that should be obtained, as the goal of the experiment; so that students lost interest, as well as the opportunity to develop capabilities and abilities, which are essential for their professional lives, provided by a good experimental training.

This kind of method can limit the vision that students have on the experimental practice, leading students to think that experimentation plays a minor role in science and prefer to become a theoretical physicist. A rigid and restrictive experimental course can mean a barrier to develop skills such as: critical thinking, problem solution orientation, hypothesis formulation, etc.

Having these ideas in mind, we launch an effort, looking for alternative methods of experimental teaching in the Physics department of the Facultad de Ciencias of the Universidad Nacional Autónoma de México, and this proposal comes up.

The method here proposed is not strictly based in one pedagogical theory but it has ideas of the constructivism learning theory which is based on observation and analysis. Students construct their own understanding and knowledge of phenomenon, through experiencing and taking into account those experiences. If they encounter something new, they have to check against it with previous ideas and experiences, maybe changing what they believe, or maybe discarding the new information as irrelevant. In any case, they actively build their own knowledge, to do this, they must ask questions, explore and evaluate what they know. Always guided by the teacher, students construct their knowledge actively rather than just mechanically acquiring knowledge from the teacher or the textbook. We considered also some proposal of interactive methods of teaching (Etkina et al).

The method can be summarized in the following steps:

- reproduction of a system, a phenomenon already known, or propose a project on which students want to focus their attention;
- observation and reflection set out hypothesis that explain what is observed in the phenomenon being studied;
- design one or more experiments to test the proposed hypothesis;
- observation and reflection, once more, to confirm hypothesis;
- recognition of important variables to the experiment and suggestion on how to quantify them;

- analyze the results; and
- draw up a model, which allows prediction of results under conditions different to those under which the experiment has been conducted.
- If necessary, to reconsider hypothesis and carry out complementary activities.

2. Experiments carried out and results

This work is an example of the type of experiments designed and carried out by a group of three undergraduate students (José Antonio Zárate Colín, Marisol, Rodríguez Arcos and Karina Ramos Musalem), as students of physics of the Facultad de Ciencias of the Universidad Nacional Autónoma de México, The project arisen from a final project for an experimental course of third semester course (Collective Phenomena) of the Physics Curriculum of the Facultad de Ciencias of the Universidad Nacional Autónoma de México. Students had to choose the project and the only condition was to choose a phenomenon, which aroused their interest and comprised the topics (thermodynamics, fluid mechanics and waves) studied in the course during the semester. After a bibliography search, they read some papers and choose (Chen, Rossing), the singing wine glass phenomenon. For this project they carry out the experiment presented here as the two first stages (dependence of the resonance frequency on the wine glass shape and dependence of the resonance frequency on volume of liquid inside a wine glass). For these stages they worked during a month in the laboratory class time.

After finishing the semester they were so interested on the subject that they asked the teachers to continue with experimentation during their leisure time, for almost one year. They work in a laboratory, which is not used for classes.

Vibration and waves are classical topics in all physics curricula. One of the more usual lecture demonstration is to make a wine glass sing by rubbing its rim with a wet finger. Young people are very familiar with the phenomenon and many street musicians can even be found giving concerts with wineglasses containing water, but most of the students only observe and they never analyze and quantify. In this work, we present the results of the study of the phenomenon well known of a “Singing Wine Glass”; on which the group of students focused their attention.

A wine glass can be simple and complex at the same time: to produce sound is easy but to understand the phenomenon and quantify it is different matter. As a topic for physics courses can be not only an amusing event but also a very useful instrument of learning and can become an excellent way towards experimentation.

The student’s work was done during the time they fulfilled their course requirements for the B.Sc. degree, and it comprising different stages, in which some goals were reached via different experiments the students carried out, and follow the method proposed. Most of the time they worked alone but their teachers Marcos Ley Koo and Estela Margarita Puente Leos always supervised them.

The study was divided into four main stages:

Dependence of the resonance frequency on the wine glass shape.

Students wondered about the variables on which depends the frequency of sound produced while rubbing the rim of a wine glass. The first hypothesis was that the wine glass resonance frequency depends on shape and the volume of liquid inside of it. So they observed and they carried out hypotheses that explain what they observed.

Firstly, in order to analyze the dependence on shape they use four different shape wine glasses (figure 1): a champagne glass, a Burgundis glass, a cocktail glass and a red wine glass.



Figure 1. Different shape wine glasses (from left to right): champagne glass, Burgundis glass, cocktail glass and red wine glass

With the help of a laptop, a microphone, and the digital audio editing software Goldwave the sound produce while rubbing with a wet finger the rim of each shape of the wine glasses was recorded, analyzed and the natural vibration frequency for each shape obtained. The results obtained allowed to conclude that the frequency depends on the shape. Resonance frequency is greater when its shape is closer to that of a cylinder and smaller when is more spherical.

Dependence of the resonance frequency on volume of liquid inside a wine glass.

The wine glasses were filled with different amounts of water to obtain a relation between the volume and the frequency for each type of wine glass when its rim is rubbed. Again with a microphone, a laptop, and the software Goldwave the natural vibration frequency was obtained.

The results showed (figure 2) that frequency decreases as liquid filling volume increases, and this behavior is independent of glass shape. No matter which shape is, frequency depends no linearly on volume of liquid inside. As sound obtained while rubbing the rim of the glass, depend on the resonant cavity and when the amount of liquid changes the resonant cavity changes, frequency changes. This would be able to be confirmed using glasses of same form but of different size.

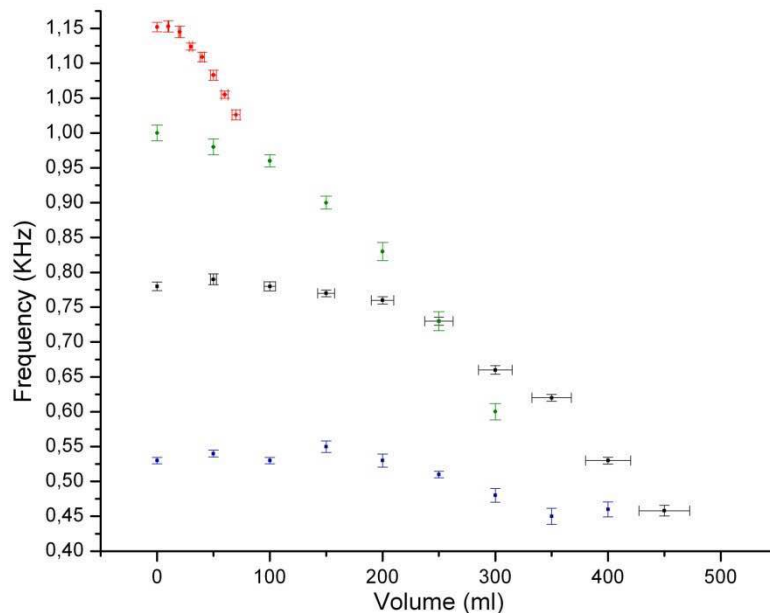

Figure 2. Dependence of frequency on volume of liquid inside a wine glass

Dependence of the resonance frequency on the kind of liquid inside.

After finishing the experiment, students continued to design more experiments to test the formulated new hypothesis. So, they asked themselves what would happen if instead of water they used another liquid: Frequency changes?. On which characteristic of the liquid depends? Once more, they observed and thought about, in order to confirm the hypothesis.

Wine glasses were filled with different liquids; the characteristics studied were density, viscosity and compressibility. With this goal in mind, students carried out three experiments so they could study the dependence of the resonance frequency of the glass wine with respect to different properties of the liquid that it contains.

Again, with a microphone and a laptop, the vibration frequency was measured for different kinds of liquids. To observe the effect of changing density, students worked with one wine glass filled with 200 ml of liquid. They use a mixture water-alcohol, and the proportion of water and alcohol was changed, from 10 ml to 200 ml of alcohol, the total volume was always 200 ml. With this process, liquid density was less than water. In a similar way, they work with a mixture of corn syrup and water, so liquid density increased. With Goldwave software, students while rubbed the rim of the wine glass, recorded during 30 s in order to obtain frequency. Frequency does not change meaningfully within the density range evaluated. So, students concluded that frequency does not depend on density, but this cannot affirm for densities ranges out of those of experiment.

In order to observe if frequency depends on viscosity, students use liquids of different viscosities: corn syrup, auto motor oil (SAE 40), glycerin, ketchup, peanut butter, liquid chocolate, condensed milk, salad dressing, y shampoo. Frequency was measure for 200 ml of each liquid. Viscosity was obtained with a Brookfield DV-II viscometer.

Data shows that frequency depends of viscosity, but, with the amount of data obtained, it was not possible to predict its behavior.

To evaluate the hypothesis that frequency depends on isothermal compressibility, students did not measure the compressibility but they qualitative changed it. They use a wine glass of 450 ml of capacity and a mixture of water and gelatin. More gelatin less compressibility. With 300 ml of mixture inside, they waited to thicken and measure frequency while rubbing the rim of the wine glass. From data, frequency decreases with increased compressibility

Energy needed to break a wine glass.

During the experiments, students questioned if the frequency value obtained with the software was the right one, due to the non-controlled way of making the wine glass to vibrate. They used their finger to rub the rim of the wine glass, so they suppose that if the frequency obtained was the fundamental frequency of the wine glass, then they could make it to vibrate until reach the resonance and the wine glass would break. The obtained a mean frequency of 650 Hz.

They propose the following method: the fundamental frequency for different wine glasses without liquid inside was found knowing the resonance frequency of the wine glasses, with the help of a signal generator, a speaker and an amplifier, the wineglasses were excited at their resonance frequency until they were broken. Electric power supplied to the speaker, as well as the time needed to break the wine glass were measured in order to quantify the energy needed to rupture.

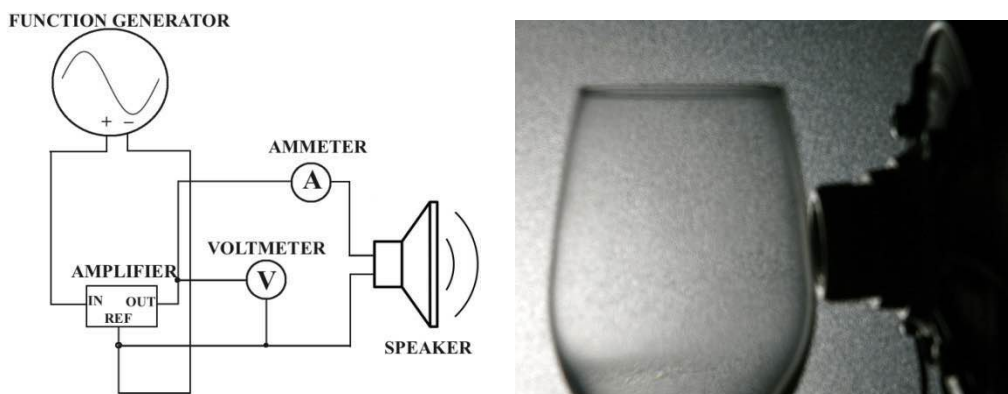

Figure 3. Experimental set up use to vibrate wine glass until reach the resonance and breakup.

A high definition and a high speed cameras were used to record the standing waves formed in the rim of the wineglasses. The resulting photographs and videos were analyzed with a Tracker video analysis and modeling software and it was possible to obtain quantitative results.

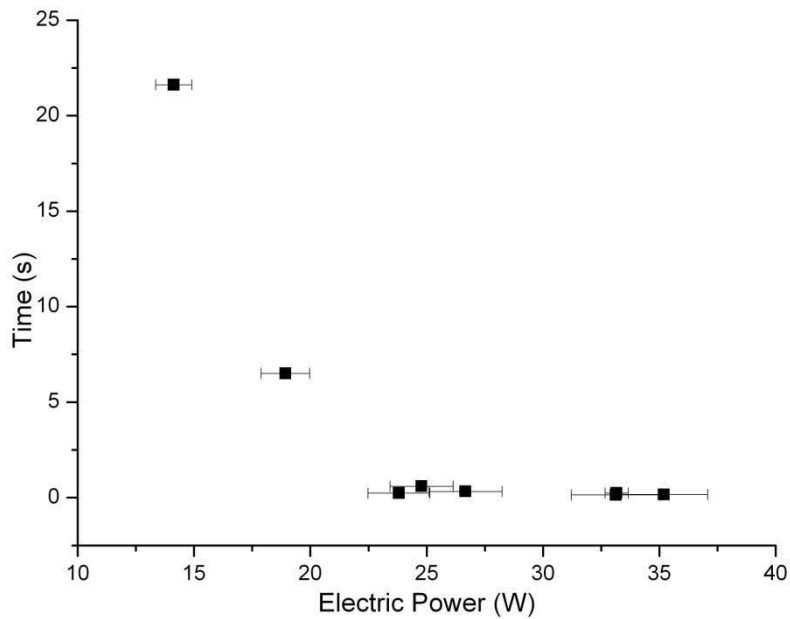

Figure 4. Time needed to break the wine glass vs electric power supplied to the speaker

From data obtained, after a log-log plot, it was possible to quantify the energy needed to break the wine glass, arriving to the equation:

$$P = 10^b t^a \quad (1)$$

where t is the Time needed to break the wine glass and P is the electric power supplied to the speaker, and,

$$a = (-5.7 \pm 0.6) \text{ and } b = (7.6 \pm 1.6) \quad (2)$$

From here we have, from the electric power supplied to the speaker, as $P = \frac{dE}{dt}$, integrating, we obtain for the energy (E) need to break the wine glass:

$$E = \frac{10^b}{a+1} t^{a+1} \quad (3)$$

Students continued to have questions: from the relation between the time needed to break the wine glass and electric power supplied to the speaker, they found a value for the electrical energy used to break the wine glass, but was this energy the same of the acoustical energy transferred to the wine glass during the process?. So, finally, with the help of a decibel meter they obtained the relation between the sound pressure obtained from the speaker and electric power supplied to it. Frequency was fixed at 650 Hz, the mean resonance frequency of the wine glasses.

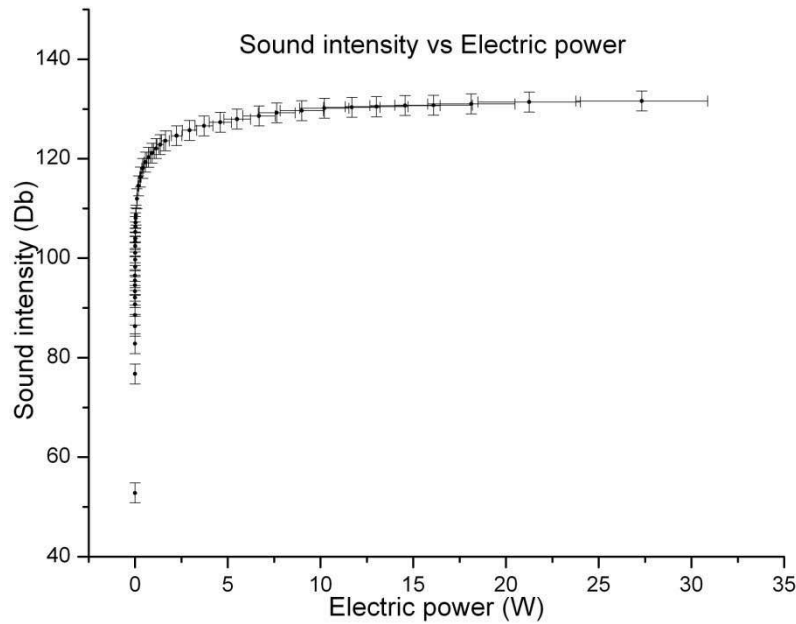

Figure 5. Sound intensity obtained from the speaker vs electric power supplied to the speaker.

From figure 5, relation between sound intensity (I_a) obtained from the speaker and electrical power supplied to the speaker (P_e) is a logarithmic relation:

$$I_a = 14.3 \log(P_e) + 121.0 \quad (4)$$

In acoustics (Kisnley et al, Heller), sound pressures and intensities are usually described using logarithmic scales known as sound levels. This is because most of sound pressures and intensities vary from 10^{-12} to 10 W/m^2 . Logarithmic are consistent with the humans sensing of the relative loudness of two sounds by the ratios of their intensities. The decibel (dB) scale is used in acoustics as a unit of sound levels,

Sound intensity is defined as the sound power per unit area. The intensity level (IL) of a sound is defined by

$$IL = 10 \log_{10} \left(\frac{I}{I_0} \right) \quad (5)$$

where I_0 is the reference intensity, which is the standard threshold of hearing intensity, IL is expressed in decibels referenced to I_0 $10^{-12} \text{ watt/m}^2$.

Since audible sound consists of pressure waves, one of the ways to quantify the sound is to state the amount of pressure variation relative to atmospheric pressure caused by the sound. Because of the great sensitivity of human hearing, the threshold of hearing corresponds to a pressure variation less than a billionth of atmospheric pressure.

As the intensity and effective pressure of progressive plane and spherical waves is related by $I = p^2 / \rho_0 c$, then the sound pressure level (SPL) can be expressed as the effective sound pressure of a sound p relative to a reference value p_0 .

$$SPL = 20 \log_{10} \left(\frac{p}{p_0} \right) \quad (6)$$

SPL is measured in dB referenced to $p_0 = 20$ micropascals in air. This reference pressure in air is set at the typical threshold of perception of an average human.

Sound power level (SWL) or acoustic power level is a logarithmic measure of sound intensity in comparison to a reference level of 10^{-12} watt (1 pW).

$$SWL = 10 \log_{10} \left(\frac{P_a}{P_0} \right) \quad (7)$$

Sound Power Levels and Sound Pressure Levels are expressed in decibels, but they are not the same decibels. The decibel is only used to compress a wide range of absolute values into a manageable range. It is not an absolute unit, but is a ratio. Without a reference level, it means nothing. The sound power level indicates the total acoustic energy that a machine, or piece of equipment, radiates to its environment. The sound pressure level is a measure for the effect of the energy of an acoustic source (or a collection of sources) and depends on the distance to the source(s) and acoustic properties of the surroundings of the source

From equation (4), and taking into account equations (5) and (7), for the sound power P_a , we have:

$$P_a = 14.3 \log(P_e) + 121.0 = 10 \log_{10} \left(\frac{P}{P_0} \right)$$

$$10^{121.0} P_e^{14.3} = \left(\frac{P}{P_0} \right)^{10}$$

Then,

$$P = 10^{12.1} P_e^{1.4} P_0 = 10^{0.1} P_e^{1.4}$$

as, P_0 is 10^{-12} watt, we have a relation between the sound power P obtained from the speaker and electrical power supplied to the speaker (P_e).

Students wonder about more questions about the singing wine glass phenomenon, but they must continue with other projects and new experiments.

Conclusion

- The method used for experimental teaching motivated students to continue making experiments even outside classroom and beyond the original course.
- Students learned to apply acquired knowledge, from different areas of physics, to propose an experiment and carried it in different stages, in order to analyze the phenomenon they were interested on.
- Students could confirm or reject the hypothesis they suggest at different stages of the experiment.
- Students learned to perform critical analysis, which improved their ability to solve technical as well as conceptual problems.

References

- Chen Yoh-Yuh. (2005). Why does Water Change the Pitch of a Singing Wineglass that Way it does?. *American Journal of Physics*. **73**. 2-6.
- Etkina Eugenia, Planinsi Gorazd, Vollmer Michael. (2013). A Simple Optics Experiment to Engage in Scientifics Inquiry. *American Journal Physics*. **81**. 2-9.
- Kinsler, Laurence E., Frey, Austin R., Coppers, Alan, B. and Sanders, James V. (2000) *Fundamental of acoustics*. 4th edition. John Wiley and Sons, Inc. USA
- Heller, Erick J. (2013).. *Why You Hear What You Hear*. Princeton University. USA.

Rossing, Thomas D. (1990). Wine Glasses, Bell mode, and Lord Rayleigh. *The Physics Teacher*. **28**. 2-5.

Affiliation and address information

José Antonio Zárate Colín, Marisol, Rodríguez Arcos, Karina Ramos Musalem, Estela Margarita Puente Leos and Marcos Ley Koo
 Laboratorio de Acústica,
 Departamento de Física,
 Facultad de Ciencias,
 Universidad Nacional Autónoma de México,
 Circuito Exterior, Ciudad Universitaria,
 04510, México, D.F., México
 e-mail: antonioyakuza@gmail.com
 e-mail: mpl@ciencias.unam.mx
 e-mail: mlk@ciencias.unam.mx

Appendix: An example of 45-minutes experimental problem for 8th graders in 2010/2011 (E1-8): Density of inhomogeneous matter

We present an example of experimental problem, which was to be solved individually in 45 minutes. For each task the number of points for correct answer is given in brackets and the cognitive level of the task according to revised Bloom's taxonomy is given in square brackets.

Equipment: a measuring cylinder 100 ml, a balance, a measuring cup, beans, grits.

During this experiment you measure how density of the bean and grits mixture depends on the mass fraction of grits. You should measure volumes as precisely as you can.

Measure densities of beans and grits. Write down the results.

(2 points) [Bloom taxonomy: apply]

Put 40 ml of beans into the measuring cylinder. With a measuring cup gradually add cups of grits into the cylinder. At each step measure the mass m and volume V of the mixture. Add 10 cups altogether.

Write the results of your measurements in the table.

(2 points) [understand, apply]

N of cups	0	1	2	3	4	5	6	7	8	9	10
M [g]											
V [ml]											

Plot a graph showing density of the mixture ρ_m depending on the mass m_z of grits in it.

(4 points) [apply]

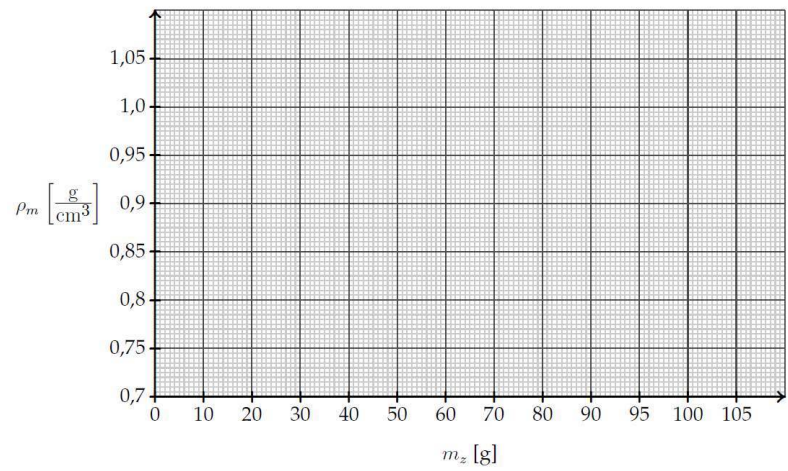

Predict how the plot will continue if you add more cups of grits. Plot your prediction with dashed line.

(1 point) [analyze]

How many (kilo)grams of grits would you have to mix into 1 kg of beans to get the most dense mixture?

(1 point) [create]

Informal Teaching of Physics at a Hungarian Science Center

Péter Mészáros

ELTE Budapest and Mobilis Science Center Győr, Hungary

Abstract

Nowadays, students do not like learning physics at school; however, for the development of economy, experts with sufficient scientific knowledge are required. Therefore, the greatest challenge is to develop a enthusiasm for science in students. At the Mobilis Science Center physics is taught by informal teaching methods in the fields of transportation and engineering. These demonstrated main topics are the following: The most influenced age range by the stereotypes of adults are the the primary school students. Parents and teachers should be motivated to reform their approach. This project also supports the vocational guidance of students. Schools' financial and human resources are limited; as a result, methodological assistance should be provided to them. Schools do not possess the appropriate tools for talent scouting and fostering. To cultivate this, new methods are needed to be developed in cooperation with the schools. Public education, higher education and economy frame together is a system; therefore, the connection between the components should be strengthened. This is realised in special themed events with the use of custom-developed tools.

Keywords

science center, informal teaching, vocational orientation, methodological assistance, experiments

1. Mobilis Science Center and the vocational orientation

Physics can be learnt not only inside the school walls. Long-lasting knowledge, deeper understanding, and creative practice skills could be obtained in a non-formal, adventurous, and inspiring atmosphere through the demonstration of complex problems and innovative teaching methods.

The best places of informal education are the world wide popular science centers. One of these centers is the Mobilis Science Center located in Győr, Hungary with its unique transportation theme in Europe. 'Learning by doing' is the center's motto, which means that informal teaching methods like the dissemination of knowledge and learning through discovery and experiment are put into practice.



Figure 1. Experiments with liquid nitrogen

The activities at a science center motivate and help students, teachers, and parents. Through the quite narrow window of transportation, people can get closer to various applications and better understand the basic theories of natural science and engineering. Meanwhile, the participants of industry, primary and tertiary education become fused into an integrating process, which activates them, improves their creative thinking and provides a surface for cooperation.



Figure 2. How does it works? The visitors can learn about how to operate a vehicle

One of the most important goals of science centers is to introduce the values of natural sciences in pair with changing the approach of visitors and to promote positive attitude towards the fields of science. This should be started in the early ages of childhood. It is easy to arouse kids' interest; however, it is much harder to keep the long-term attention of teenagers'. The primary target group of Mobilis Science Center is teenagers between the age of 13 and 16, but the center is able to entertain and inform people between 6 and 100. Parents can join themed experiment shows and try out interactive exhibits which have a significant role in approach forming. Most of the games have several, equally good solution, so they are prominent in knowledge widening. Parents' way of thinking and their attitudes provide the basis of children's career choice. Accordingly, we highly promote family visits, when parents can play and learn with their children. We strongly believe in narrowing the gap between generations and to exchange their experience.



Figure 3. Vocational orientation through playing

One of the biggest problems in Hungary is that youngsters have lost their interest in technical professions and disciplines. In Győr, the vehicle industry (Audi and its partners) offers great career possibilities for young people. As a result, our programs are aimed to guide children to these directions, since a lot of training is needed to become an expert in this field. Elementary school students are oriented towards high school education, in order to choose from the many trainings Győr offers them in its technical secondary schools. On another level, high schools' graduate students are oriented towards technical and science Universities. Mobilis has a great location as it is in the neighbourhood of one of the biggest technical universities in Hungary called Széchenyi István University.

The programmes in a Science Center try to cover a wide range of subjects, in order to satisfy public interests. Some of the special events Mobilis took part in: European Mobility Week, old-timer cars reconfigured to be electric ones, exhibition of military techniques, Mini Science Picnic, Night of the Researchers, Night of the Museums, projects in co-operation with the Széchenyi University.

With its numerous interactive devices Mobilis exhibits the traffic's many aspects like engineering, logistics, technology, science, history, aesthetics and sociology. On our project days experimentations and competitions are organised where university students, local and regional companies can present their latest developments (e.g. alternative-powered vehicles, solar bicycle charger, computer applications: virtual reality, 3D design). Events like these project days also give opportunity to visit the laboratories of Széchenyi István University (e.g. Audi-lab, other technologies).



Figure 4. High School visitors at Audi-lab

In jUNIor University, professors give lectures about their research on various areas to secondary school students. We organize roadshows in schools together with automotive companies. On our vocational guidance roadshow organized with Széchenyi István University, 6 engineering courses are promoted for high school students. 2 custom-developed exhibits per majors are represented and experiments are held with probe able tools.

2. Methodological assistance and talent development

Science centers are the link between informal training and school education. Science centers provide supplementary education, they are based on the curriculum and teaching methods of traditional subjects such as physics and chemistry. A science center could never replace classic school education, it only expands it.

Methodological assistance and additional opportunities are given to teachers and schools. Teacher's fear has to be dispelled: their task and their talented students will not be stolen from them; in fact, multiple possibilities of motivation, valuable information and ideas will be given to them in addition. Searching and mentoring talented students is also one of the most important goal of a science center.

We were mentoring a high school student at an international innovation competition (he designed a vehicle made by superconductor). From June to August summer camps are organized where children learn how to research and do various natural scientific experiments. There are tenders for university students to create more experimental tools. Children between 8 and 13 can take part in talent study groups in cooperation with their own schools (study groups based on tablet PC, „Young Physicist” groups). Mini Science Picnic is also one of our organizations, where talented high school students together with their teachers present experiments all day long. This event is also an experiment developing competition.



Figure 5. 30 High School groups made experiments in Mobilis at the event Mini Science Picnic

Another contest is AttrActive Science, which consists of a general natural scientific and technological quiz, a scientific presentation and a short experiment show. With the sustainable transport in focus, we have an E-gokart study group, too. The team competition called The TechTogether is designed for Hungarian university students, where groups' logical, engineering and designing skills are tested. The Junior version of TechTogether is organized to support vocational guidance for high school students across the country. At Mobilis, on demand, students are prepared for the high-level physics school leaving exam in another study group. Moreover, there is a Lego robot study group available for children between 8 and 12.



Figure 6. Talented students with his vehicle made by superconductor

Project days' themes and applied methodologies vary on a large scale. Mobilis can simultaneously occupy 80-120 students. They can be involved in competitive tasks, visit lectures presented by guest performers on natural science issues, take part in quizzes, try out and make experimental devices and probe special, occasionally available activities (e.g. test and learn the mechanism of vehicles run by solar cells, natural gas or electricity).



Figure 7. Solar- and pneumobils developed by students of Széchenyi István University

Besides our own competitions, Mobilis provides a venue for regional, national and custom-developed contests, as well. There is also an opportunity to join special classes, which are held in 6 different topics in the domain of physics and chemistry. For teachers' request, unique themes can be created in basic or special physics subjects.

There are conferences for high school teachers and university lecturers about how to improve their talented students' knowledge, organize study groups and about physics teaching. In cooperation with Széchenyi István University, a science communication subject is developed. The local science teacher training on higher education level is also fostered.

Special, own developed tools, experiments

Part of the big interactive exhibits (6 out of 74) are based on my own ideas. On the air-cushion table we presented the aquaplaning phenomenon in a TV show, which introduced the physical aspects of Formula 1. This TV series consisted of 8+4 episodes and I was responsible for providing the background support for its professional content. All the hands-on-experiments are self made/original design. Some of them also won awards, such as the fire tornado, which has got four variations. Besides the regular experimental demonstrations in the Mobilis Center, experiments can be seen on our interactive online surface and we also present them on outside festivals. Our toolbar is improved in cooperation with companies (e.g. Lenz-cannon). For the thermal experiments we use an infrared camera. At the tinkering workshops those who take part can take home their self made products. The experiments present the physics and chemical side of the vehicles and transport.



Figure 8. Water explosions with liquid nitrogen at external events

Visitors' interest in physics and their motivation to learn more can be enhanced by making experiments and measurements personally and by showing them innovative devices and spectacular phenomenon. It was proved that the motivation of teachers and students can be increased by systematically organized visits to the Science Center. The increasing number of periodic visitors, co-operations with schools and industrial partners shows that transportation is an excellent topic to motivate. Although lot of exhibits and lectures are placed in the Center, to meet with the Hungarian educational and pedagogical requirements, more industrial or governmental support is needed. With these sources, it would be possible to purchase new experimental devices or to organize more special themed roadshows.



Figure 9. The self developed fire tornado

Affiliation and address information

Péter Mészáros

PhD student – professional and methodological leader

ELTE Budapest – Mobilis Science Center Győr, Hungary

Vásárhelyi Str. 66.

9026 Győr, Hungary

e-mail: meszaros.peter@mobilis-gyor.hu

Chapter 8

History and Philosophy of Science in Physics Education

Recasting Particle Physics by Entangling Physics, History and Philosophy.

Eugenio Bertozzi, Olivia Levrini

*Department of Physics and Astronomy,
Alma Mater Studiorum, University of Bologna. Italy*

Abstract

The paper presents the design process we followed to recast particle physics so as to make it conceptually relevant for secondary school students. In this design process, the concept of symmetry was assumed as core-idea because of its structural and foundational role in particle physics, its crosscutting character and its epistemological and philosophical value.

The first draft of the materials was tested in a pilot-study which involved 19 students of a regular class (grade 13) of an Italian school. The data analysis showed that the students were in their “regime of competence” for grasping subtle nuances of the materials and for providing important hints for revising them. In particular, students' reactions brought into light the need of clarifying the 'foundational' character that symmetry attained in twentieth-century physics.

The delicate step of re-thinking the materials required the researchers to articulate the complex relationship between researches on physics teaching, history and philosophy of physics. This analytic phase resulted in a version of the materials which implies the students to be guided to grasp the meaning of symmetry as normative principle in XX century physics, throughout the exploration of the different meanings assumed by symmetry over time. The whole process led also to the production of an essential, on-line version, of the materials targeted to a wider audience.

Keywords

Symmetry, particle physics, physics education research, history and philosophy of physics.

1. Introduction

The main goal of the paper is to present the design process we followed with the goal of recasting particle physics so as to make it conceptually relevant for secondary school students.

The process foresaw a first production of teaching materials for introducing elements of particle physics at school, their testing in a pilot-study, data analysis and successive revision of the materials themselves. In this paper, we will show *how* and *when* issues of meaningfulness raised by the students required the researchers to articulate, in a specific way, the relationship between the disciplinary contents presented to the class (particle physics concepts) and historical and philosophical considerations. The paper is organized as follows:

- in Section 2 arguments supporting the choice of introducing particle physics at secondary-school level are discussed together with the relevance that the concept of symmetry can play for recasting this physics domain from an educational perspective;
- in Section 3 the pilot-study testing a first draft of the teaching materials is briefly described (rationale of the experiment, teaching materials, methods of data analysis) and a special emphasis is posed on those data which triggered the successive phase of re-thinking to the materials;
- in Section 4 the phase of re-thinking is fully described: it will be shown what questions researchers have set in response to specific issues raised by students and what role was played by the of history and philosophy in answering these issues. The analysis led to the design and realization of a virtual exhibition within the Museo-Officina dell'Educazione (MOdE) of the University of Bologna.

2. State of the art

The problem of introducing elements of particle physics at the secondary-school level has recently received a renewed attention in Italy in the light of the fact that the reformed secondary school curricula (MIUR, 2010) requires students of “Liceo Scientifico” to address, at grade 13, topics belonging to twentieth-century physics. The new requirements raise several issues of concern for Physics Education Research (PER), from

the teacher-training to the realization of suitable materials. It is well known for example that, because of the advanced and specialized character of the topics, textbooks usually present particle physics as a fragmented patchwork of notions (pieces of historical information, experimental results, theoretical hypothesis) which sounds as a sort of “appendix” to the central body of knowledge represented by classical physics.

The plausibility of introducing selected topics belonging to the twentieth-century physics at secondary-school is not new within PER: the last thirty years have seen a relevant number of studies supporting the idea that an educational research-based introduction of relativity, quantum physics, even of the quantum theory of the fields, can confer to the study of physics an exceptional cultural relevance (Levrini, Fantini; 2013; Bertozzi; 2013).

The materials we produced on particle physics were structured on the concept of symmetry. This concept occupies a prominent place within the PER panorama and not only. Starting from the works of Weyl and Wigner, the concept of symmetry played a significant role firstly within the reflections that scientists developed about physics itself (Weyl, 1952; Wigner, 1967). Then, since Feynman Lectures on Physics (Feynman, 1964), the roles that symmetry can play in education have been progressively investigated. Recently, within the field of physics education, some scholars have been exploring the conjecture that re-designing the physics curriculum, or parts of it, by emphasizing the foundational role of symmetry can help physics to become meaningful, interesting and relevant for a large number of students. The studies regarding relativity and conservation laws are achieving interesting and promising results (Hill, Lederman 2000; Van der Veen, 2012; 2013; Van den Berg, 2006). It is within this framework that we assumed that the concept of symmetry could be the core-idea for developing teaching materials aimed at enabling students to grasp the fundamental features of particle physics.

3. The pilot-study

A detailed description of the pilot-study and of its first results has been already published (Bertozzi et al., 2014) and only a brief overview of them is provided in this section. The aim of this overview is to bring out the aspects that imposed us, as researchers, to re-think of the materials and, at the same time, to bring into light the contribution that researches in history and philosophy of science can provide for this purpose.

Experiment design: classroom context, materials and data sources

The experiment involved a regular class of 19 students, grade 13 of an Italian scientifically oriented secondary school (Liceo Scientifico “A. Serpieri”) in Rimini (teacher M. Rodriguez). At the time of the experiment, the class had been studying physics as mandatory course along the five years of upper secondary school (grades 9-13).

The materials used in the experiment consisted of a document about antimatter and of a lecture, held by one of the researchers (EB) where students had been introduced to the essential aspects of particle physics. More specifically, the document included two different texts on the same topic (antimatter): the first text was taken from the website of the Exploratorium in S. Francisco¹ and, in researchers' opinion, it represents an example of the common, paradigmatic, way of presenting antimatter to non physicists. The second text was elaborated by the researchers as an alternative way of introducing antimatter by assuming symmetry as “key-concept”: in particular, the symmetry observable in a bubble-chamber in electron-positron pair production was discussed in the light of the symmetries that can be observed in other situations (e.g. an ice-crystal and a musical sheet).

The 2 hour lecture was divided in three segments: each segment focuses on a specific aspect concerning symmetries in contemporary particle physics. In particular:

- a) Symmetry and the properties of space and time: translation, rotation (continuous);
- b) Symmetry and properties of the particles: C, P and CPT symmetries (discrete); electric charge, spin (internal);
- c) Symmetry as a tool for classification and prediction: historical episodes coming from cosmic ray researches.

Data on students' reactions to the teaching materials were collected through: *a)* a questionnaire designed to guide the students in a critical analysis of the two texts about antimatter; *b)* audio-recordings of the lecture and the classroom discussion which was carried out the day after the lecture; *c)* an individual written task.

1 The text “Antimatter” is available at <http://www.exploratorium.edu/origins/cern/ideas/antimatter.html>

Data analysis

With regard to the main goal of the study, i.e. making particle physics (usually presented as an “additional appendix”) conceptually relevant for secondary school students, the analysis of students' reactions brought into light that a promising way of achieving the goal had been intercepted. Students appeared to be in their regime of competences for grasping subtle nuances of the materials, picking up different roles that the concept plays in physics and for ascribing the concept an inner epistemological value. For example, since the analysis of the texts, some students were able to recognise a methodological role of symmetries for the development of science. In the words of Isabella:

“Scientists try to explain the world around us by means of laws of symmetry and, if they find some anomalies, they try to discover their origin and to solve them [...]. [the second text on antimatter] provides us with information not only on antimatter but, just, on the way of thinking of physicists themselves and on what pushes scientists to research” (Isabella)

At the same time, a significant part of the classroom discussion carried out the day after the lecture, brought into light a specific point: the idea that symmetry becomes a fundamental principle in contemporary physics clashed with the discussed examples, like the pair production process as observed in a bubble-chamber, where symmetry emerged as a phenomenological regularity. The students complained about this as follows:

“I thought that contemporary physics considers symmetry a fundamental principle. Seeing symmetry in the phenomenon...it seems strange. It seems that you can have different symmetries according to different phenomena. Maybe here in the case of the photon I have a certain symmetry while in another....” (Lorenzo)

“So, is it a fundamental principle or something that you observe and understand that it is always there?” (Luca)

This reaction deeply problematized how the so called *foundational character* of symmetry was introduced in the materials: our interpretation was that the distrust expressed in this particular classroom context was the signal that relevant elements were missing in the overall structure of the discourse. Specifically, a more complex and rich way of contextualizing symmetry in twentieth-century physics was needed and, somehow, claimed.

4. Re-thinking

As hinted in the introduction, the search for the missing elements of knowledge triggered a process of re-analysis on the relationship between physics contents, philosophy and history of physics: along this process, we re-thought about the first draft of the discourse that structured the materials so as to incorporate students' requirements. The process implied us to:

- a) carry out a deep philosophical analysis on the so called *normative role* of symmetry as peculiar for the physics of the last century;
- b) search for a way to illustrate this meaning to a non-specialist audience.

After the presentation of the results of this process, we will show how the new discourse about the symmetry guided the design and realization of a virtual exhibition for a wide audience that intends to include secondary school students.

Symmetry as normative principle: philosophical studies and educational perspective

The physicist, mathematician and philosopher Eugene Wigner, in his "Philosophical Reflections" published in 1967, picks up a precise moment in the history of physics, after which the *normative role* came into playing:

"The significance and general validity of these principles were recognized, however, only by Einstein. His papers on special relativity also mark the reversal of a trend: until then the principles of invariance were derived from the laws of motion. Einstein's work established the older principles of invariance so firmly that we have to be reminded that they are based only on experience. It is now natural for us to try to derive the laws of nature and to test their validity by means of their laws of invariance, rather than to derive the laws of invariance from what we believe to be the laws of nature" (Wigner, 1967)

Wigner's statement draws the attention on Einstein's use of symmetry principles both in Special and in General Relativity (covariance): successive literature on philosophy of physics extensively quotes the two cases as paradigmatic examples of how the requirement of invariance acts as a restriction on the form that a theory may take. Gauge theories and their relation with fundamental interactions extend this paradigm to particle physics and complete the framework of the *normative role* played by symmetry within the physics of the last century.

While Wigner is focussing on the role of *symmetry* for *the laws* of physics, the Italian physicist and philosopher Giuliano Toraldo di Francia stresses the relationship between *symmetry* and the *micro-objects* of physics: unlike the objects of classical physics that display a *contigent* nature, particles, the objects of contemporary physics, displays a *nomological* nature being "knots of invariants properties prescribed by the laws" (Toraldo di Francia, 1978, 1998).

These two cues concerning the fundamental, normative, role of symmetry in defining *the shapes of the laws* and *the objects* became the basis of the elaboration of apposite schemata in order to make these cues accessible to a non specialist audience: in these schemata, we establish an analogy between the symmetry properties of simple geometrical figures and the symmetry properties of the elementary particles and of the *laws* governing their interactions. The negative character of these analogies marks the transitions from a classical view of physics to a contemporary one, bringing into light an inner, educational value. The tenability of the proposed analogies has been already discussed in apposite environments (conferences and journals) where the relationships between symmetry and physics are at issue (Bertozzi, Levrini, 2014).

The shape of the laws

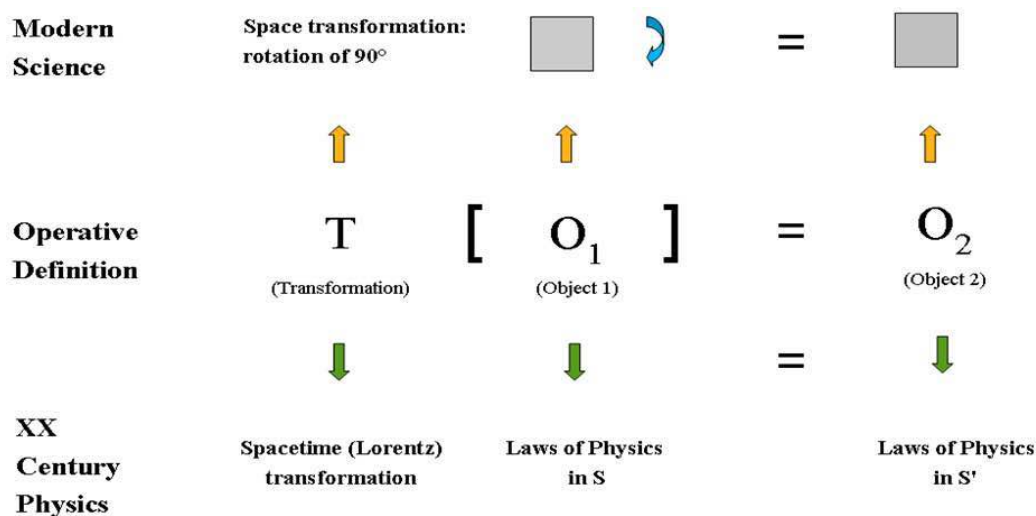

Figure 1. Operative definition of symmetry at work in the case of a square and a *physical law*.

Figure 1 shows how the laws of physics are normed by symmetry in twentieth-century physics. The modern definition of "symmetry as operation" developed throughout nineteenth-century is represented in the first row where it is applied to a geometrical figure (a square): in this meaning, symmetry expresses the invariance of an object (for example a square) under a space transformation (for example the rotation of 90° degrees). The general structure of symmetry is extracted from the example and reported in the second row.

The way how such a general definition of symmetry works in twentieth-century physics is reported in the third row. Here, space transformations are replaced by spacetime transformations (the Lorentz transformations of Special Relativity) and the geometrical figure is replaced by a mathematical expression (law of physics). The new transformations applied to new objects allow physicists to verify if a particular physical law maintains the same shape between different inertial systems of reference (Lorentz-invariance). In our reconstruction, these considerations mark the first encounter with the normative role of symmetry in twentieth-century: Lorentz transformations act as norms to select those laws of physics which match the relativistic framework (e.g. electromagnetism) and to point out those laws which do not (e.g. Newtonian mechanics) and must be modified.

The definition of the object

The second philosophical cue addressed by our reconstruction concerns the definition of the micro-objects (particles) in terms of their symmetry properties. Actually, if one focuses on the relation symmetry-object, the modern definition of symmetry has two different meaning, according to the perspective from which it is looked at. Indeed, the two statements "the square *is invariant* under rotations of 90° degrees" and "the square *is what is invariant* under 90° degrees rotations" are significantly not equivalent: in the first, we start from the object and, then, we recognise its symmetry properties; in the second, symmetry properties are used to

define the object itself. It is this second perspective that is adopted in contemporary physics for defining elementary particles.

Particles are detected in physical experiments by the measurement of quantities that universally identify them: electron *is what has* a given value of mass, electric charge, spin and lepton number. Such "identity-card" is just what can be characterized in terms of symmetry properties grounded on the laws of invariance²: as Toraldo di Francia wrote, particle are knots of invariants prescribed by physical laws.

The meanings of symmetry in science: historical studies and educational perspective

When observed from an historical perspective, the idea of symmetry as *normative principle* for physics appears to be the ultimate and most technical form acquired by the concept within the development of science. In particular, Castellani and Brading emphasize how, starting from the antiquities, the concept of symmetry progressively gained a modern meaning and how the word "symmetry" evolved semantically over the history of science (Brading, Castellani; 2003).

In the light of the analysis carried out, an historical path about symmetry was designed and, in collaboration with the Museo Officina dell'Educazione (MOE) of the University of Bologna, it became the basis for a virtual exhibition targeted to secondary school students and general audiences. The exhibition is available on the web.³

In the exhibition, three meanings acquired by symmetry throughout history are explored in 3 different virtual rooms and, in each room, specific objects of interest for science are displayed.

In particular:

a) the room of poliedra explores the meaning of "symmetry as proportion": from the Timeo of Plato to the *Mysterium Cosmographicum* of Kepler (1596) the principal function of symmetry was to express harmony between the different parts and the whole. The central elements of this room are *polyhedra* that, due to their inner properties of proportionality, have been privileged objects for the investigation of natural world in antiquity.

b) the room of crystals – "symmetry as operation": during the XIX century, the introduction of the group theory in mathematics led to a new, modern meaning of symmetry and turned it into a powerful classificatory tool. Crystals and their role in XIX Century physics are the central elements of the room.

c) the room of the fundamental laws and objects – "symmetry as principle": the path through the previous two rooms is supposed to put the visitor in the mood to reach the third room and to catch the essence of the examples discussed, that it to recognize: i) the plausibility of generalizing the notion of symmetry-as-operation to transformations which include time, as well as space, or refer to abstract spaces whose nature is no more geometrical; ii) the meaning of switching the common relationship between object and its properties and getting to define physical objects by means of symmetry properties.

5. Conclusions

In the paper we presented an articulated process of instructional design where students' requirements guided us to extend and deepen our reflections on history and philosophy of science to elucidate the fundamental role played by symmetry in twentieth-century physics. The new materials represent a special entanglement of physics, philosophy and history of physics, realized for educational purposes. They are now used in contexts of teacher education and, as we saw, are the basis of a realized virtual exhibition.

References

Bertozzi. E. (2013). What is what we call quantum field? Answering from a teaching perspective by taking the foundations into account, *European Journal of Physics*, **34**, 603-611

2 Within the theoretical framework of the quantum field theory, a formal construct, the action, is associated to the physical entity (particle). Noether's theorem links the symmetry properties of the action to Noether charges (e.g. energy, impulse, electric charge, spin); these quantities, that are invariant during the free evolution of the system, and globally conserved in its interactions, are the ones which are measured in physical experiments.

3 <http://omeka.scedu.unibo.it/exhibits/show/simmetriafisica>

- Bertozzi, E., Levrini, O., Rodriguez, M. (2014). Symmetry as core-idea for introducing secondary school students to contemporary particle physics, *Procedia Soc. Behav. Sci.*, **116**, 679-685
- Bertozzi, E., Levrini, O., (2014). Symmetry as Conceptual Core of the Standard Model of Physics: actions for Science Education, *Symmetry: Culture and Science*, **25** (3), 145-288
- Brading K., Castellani E. (2003). *Symmetries in Physics, Philosophical Reflections*, Cambridge University Press, UK
- Feynman R., Leighton R., Sands M. (1964). Symmetry in Physical Laws. *The Feynman Lectures on Physics*, Addison–Wesley, USA, Vol I., Chap 52.
- Ministero dell'Istruzione, dell'Università e della Ricerca (2010), Indicazioni nazionali per i nuovi Licei.
- Hill, C. T. and Lederman, L. (2000). Teaching symmetry in the introductory physics curriculum, *The Phys. Teach.*, **38**, 348-353.
- Levrini, O., Fantini, P. (2013). Encountering Productive Forms of Complexity in Learning Modern Physics. *Sc. & Ed.*, **22** (8), 1895–1910.
- Toraldo di Francia, G. (1978). 'What is a physical object?', *Scientia*, **113**, 57-65.
- Toraldo di Francia (1998). A World of Individual Objects, in Castellani E. (Ed.) *Interpreting Bodies*, Princeton University Press
- van den Berg, E. Hoekzema, D. (2006) Teaching conservation laws, symmetries and elementary particles with fast feedback, *Phys. Educ.*, **41**, 47–56
- Van der Veen, J. (2012). Draw your physics homework? Art as a path to understanding in Physics Teaching, *American Educational Research Journal*, **49** (2), 356–407
- Van der Veen, J. (2013). Symmetry as Thematic Approach to Physics Education, *Symmetry: Culture and Science*, **24**, 463
- Weyl, H. (1952) *Symmetry*. Princeton University Press
- Wigner E. (1967). *Symmetries and Reflections*, Indiana University Press, Bloomington& London

Affiliation and address information

Eugenio Bertozzi
 Department of Physics and Astronomy
 Alma Mater Studiorum – University of Bologna
 Viale Berti Pichat 6/2
 40127 Bologna, Italy
 e-mail: eugenio.bertozzi2@unibo.it

The Discovery of X-Rays Diffraction: from Crystals to DNA. A Case Study to Promote Understanding of the Nature of Science and of its Interdisciplinary Character

Francesco Guerra¹, Matteo Leone², Nadia Robotti³

¹ *Department of Physics, Sapienza University of Rome; INFN Section of Rome*

² *Department of Philosophy and Educational Sciences - Campus of Savigliano, University of Turin*

³ *Department of Physics, University of Genova; INFN Section of Genova*

Abstract

The advantages of introducing history of science topics into the teaching of science has been advocated by a large number of scholars within the science education community. One of the main reasons given for using history of science in teaching is its power to promote understanding of the *nature of science* (NOS). In this respect, the historical case of X-rays diffraction, from the discovery of Max von Laue (1912) to the first X-rays diffraction photographs of DNA (1953), is a case in point for showing that a correct experimental strategy and a favourable theoretical context are not enough to make a scientific discovery.

Keywords

History of Science; Nature of Science; X-rays; X-rays diffraction; Wilhelm Conrad Röntgen; Max von Laue; DNA;

1. Introduction

The advantages of introducing history of science topics into the teaching of science has been advocated by a large number of scholars within the science education community (de Hosson & Schneeberger 2011, Leone 2014, Matthews 1994). As it was recently observed by Matthews (2012), one of the main reasons are the “cultural, educational, personal and scientific benefits of infusing the history and philosophy of science, into science programmes and curriculum; or in current terms, of teaching about the nature of science (NOS) while teaching science”. While there has been a long tradition advocating this approach, a number of open questions about NOS still exists. These questions deal with the optimal conditions for effective NOS teaching, the relationship between learning science and learning *about* science, and the issue of effectively measuring a NOS learning. Last but not least, there is an unsettled matter of definition arising from a lack of agreement in the science education community about what actually are the fundamentals of NOS (for a list of NOS elements according to some of the most influential authors in the field see Schwartz and Lederman 2008)

Notwithstanding these serious difficulties, and a conspicuous lack of experimental efforts to study the actual effectiveness of including history of science into science classes, curricula, and teacher education, a number of historical case studies have been studied with the goal of emphasizing its educational significance. These studies, rather than providing a shared list of necessary and sufficient conditions for a practice to be scientific, identify “family resemblance of features that warrant different enterprises being called scientific” (Matthews 2012). In this respect, the discovery of X-rays diffraction by crystals, and some important outcomes like the emergence of X-rays spectroscopy and the discovery of DNA, are a case in point for showing that a correct experimental strategy and a favourable theoretical context are not enough to make a scientific discovery.

Max von Laue’s discovery of X-rays diffraction and the subsequent developments by William Henry Bragg and William Lawrence Bragg had been extensively discussed in Robotti (2012), to which we refer for a more detailed coverage of this topic.

2. The discovery of X-rays and of their nature

A major physics discovery occurred on November 8, 1895. For this discovery Wilhelm Conrad Röntgen, then professor of Physics at Wurzburg (Germany), was awarded the very first Nobel Prize in Physics (1901).

Röntgen had been studying the phenomenon of discharge of electricity through rarefied gases. By late 1860s it was known that if an evacuated glass tube is equipped with two electrodes and a voltage is applied, the glass opposite of the negative electrode (cathode) glows due to “cathode rays” (electrons) emitted from the cathode.

While working with a highly evacuated tube screened off by black paper, Röntgen discovered that a fluorescent screen brought near the tube, “lights up brilliantly and fluoresces, also if the screen is two meters away from the tube” (Röntgen 1895). This observation was entirely unexpected and soon became a classic case of accidental discovery.

Röntgen’s discovery was explained as the effect of a “new unknown form of invisible rays”. These new rays were shown to have a number of properties: they are emitted at the point of impact of cathode rays with wall of tube; travel in straight line; are highly penetrating; are able to impress a photographic plate; are neither reflected nor refracted. “For the sake of brevity” they were called “X-rays”. The new rays discovered by Röntgen were so spectacular that excited intense interest throughout the entire scientific world, and the first photographs obtained by them showed the by now reached ability to photograph the invisible.

From the year of their discovery to the first decade of twentieth century, X-rays were interpreted as electromagnetic waves of very short wavelength. However, in spite of this belief, no experimental demonstration of an analogy between light and X-rays existed. Furthermore, no reliable measurement of their wavelength was available. By 1912 both points were finally settled through the works, respectively, of Charles Grover Barkla and Arnold Sommerfeld. These accomplishments paved the way for the discovery of X-rays diffraction in crystals.

Röntgen had already attempted in 1895-97 to demonstrate the electromagnetic nature of X-rays by looking at an X-rays diffraction phenomenon by using both crystals and narrow slits. His attempts, however, got negative results (further efforts, to no avail as well, were made in 1899 by H. Haga and C.H. Wind, and in 1909 by B. Walter and R. Pohl, through wedge-shaped slits only a few microns wide). It was only in the 1906-1908 years that Barkla was able to provide strong evidence that X-rays consist of electromagnetic waves by studying the passage of X-rays through radiators. On the one hand, the scattered X-rays were indeed shown to be linearly polarized. On the other hand, heavy radiators were found to emit also a radiation “characteristic of the radiator material” (the so-called “fluorescence radiation”), in analogy with Stokes law on light fluorescence (i.e. the radiation was emitted only when primary X-rays were harder than secondary ones) (Barkla 1906,1908).

As for the measurement of X-rays wavelength, it was taken in early 1912 by Sommerfeld, who had charged P.P. Koch to measure Walter and Pohl’s plates obtained with a new photometer just devised by Koch. The light curves, analyzed by Sommerfeld by means of his new theory on diffraction through wedge-shaped slits, showed a diffraction effect. Sommerfeld found indeed a considerable spectral range of the X-rays, whose center laid at a wavelength close to $4 \cdot 10^{-9}$ cm (Sommerfeld 1912).

3. The discovery of X-rays diffraction

In the fall of 1909 Max von Laue, former assistant to Max Planck in Berlin, went as *Privatdozent* to Munich at Sommerfeld’s Institute of Theoretical Physics. As he later wrote, “it turned out to be a matter of great good fortune that Sommerfeld passed to me the article ‘Wellenoptik’ (Wave optics) at that time to work upon for the *Encyclopedia of Mathematical Sciences*” (Laue 1915). In the effort of writing the entry he developed indeed a new theory of diffraction, valid not only for a linear grating (optical grating), but also for a cross-grating (lattice grids).

Laue’s attention in Munich was drawn constantly to the question of the nature of X-rays, “owing to the influence of Röntgen’s work at this University” (Röntgen had moved from Wurzburg to Munich Institute of Experimental Physics in 1900) and as a consequence of “Sommerfeld’s active interest in X-rays” (Laue 1915). A further important circumstance was the presence in Munich of a third Institute, besides those headed by Röntgen and Sommerfeld: the Institute of Mineralogy and Crystallography. The idea of space-lattice arrangement of atoms was indeed widely known in Munich, mainly due to the role of P. Groth, director of this latest Institute.

In February 1912, P.P. Ewald, who was pursuing a doctorate on the optical properties of the lattice structure of crystals, under the guidance of Sommerfeld, asked Laue to help him to overcome some mathematical difficulties on the behavior of long electromagnetic waves in these structures (Ewald 1962). Having heard this, Laue “was suddenly struck by the obvious question” (Laue 1915), in view of his interests toward the X-rays:

what behavior one might expect by *short* waves, like waves of X-rays wavelengths (10^{-9} cm), in a space lattice (constant of the order of 10^{-8} cm)?

Laue soon grasped that a crystal should behave for X-rays as a three-dimensional diffraction grating and that therefore space-lattice spectra would have to ensue.

At Laue suggestion, W. Friedrich (Sommerfeld's assistant) and P. Knipping (a student graduating with Röntgen) volunteered to submit this possibility to experimental test.

By means of preliminary experiments with a copper sulphate crystal and a provisional apparatus, similar in principle to that used later, Friedrich and Knipping detected "a series of spots" together with a trace of the primary ray coming directly from the anticathode. The spots vanished if the same experiment was repeated with a "powdered" crystal, and similar results were obtained with other crystals. These results provided a strong support to Laue's idea of X-rays diffraction by crystals.

Friedrich and Knipping later made use of an improved apparatus, where a widespread and fairly powerful tube was used (a Müller X-rays tube), and where the orientation of the crystal was sharply defined by an accurate goniometer (Figure 1).

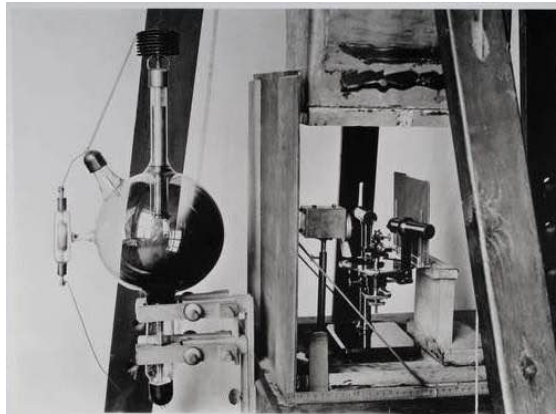

Figure 1. Friedrich and Knipping's apparatus (source: Deutsches Museum, Munich [Bragg Photos 4 nos. 86A-], Series 6. Accessed online via: William H. Bragg and William L. (Lawrence) Bragg: A guide to the research records of John Jenkin. <http://data.esrc.unimelb.edu.au/viewer/BRAG/item/BRAG00560/1>)

By this apparatus they obtained the first successful image of the X-rays diffraction in crystals, showing rings of fuzzy spots of elliptical shape, with the minor axis pointing to the overexposed centre of the black area produced by the primary ray (Figure 2) (Friedrich, Knipping and Laue 1912). To make the phenomenon more clear and easier to understand, they made the successful choice of using a cubic system crystal (the corresponding spatial lattice is the simplest possible), a zinc blende crystal, rather than the triclinic copper sulphate, previously used. Also, the sample was a plain parallel plate ($10 \times 10 \times 0.5$ mm) cut parallel to a face so that the X-rays struck the crystal perpendicularly to cube face.

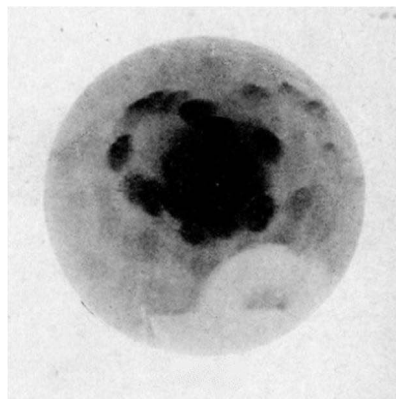

Figure 2. First successful photograph obtained by Friedrich and Knipping (source: Friedrich, Knipping, and Laue 1912)

Friedrich and Knipping found that the position of the spots was completely symmetrical in relation to the point of impact of the primary radiation. It was possible to see two pairs of planes of symmetry arranged perpendicular to each other. The fact that a completely fourfold symmetry is present on the plate was certainly the most beautiful demonstration of the space-lattice of the crystal, and of the fact that no other property than the space lattice is involved.

Other orientations of the zinc blende sample were used, e.g. if the zinc blende was irradiated along the threefold axis or the twofold axis, one could see the corresponding threefold or twofold symmetry. Also, additional samples were used, like rock salt and diamond plate.

To explain the images obtained, Laue developed the (yet nonexistent) diffraction theory for a space-lattice upon the basis of his article for the German Encyclopedia. He resumed his equation for a linear lattice and wrote it three times corresponding to the three periodicities of a space lattice. The observed rings of rays could thus be related to the cones of rays demanded separately by each of the three conditions of constructive interference. The spatial lattice considered was the most general one, that is the triclinic type (the edges of the elementary parallelepiped may thus have any lengths and be inclined at any angles to one other).

The comparison of the theory with the experimental data was done by Laue in the simplest case, namely that of zinc blende. He arrived at the conclusion that the diagrams were perfectly explainable on the assumption that the X-rays spectrum, rather than being continuous, contained only a number of discrete wavelengths and that these ones are responsible for the spots.

The discovery of X-rays diffraction in crystals benefited not only the lattice theory of crystals, but also the wave conception of X-rays. In fact, it was the triumph of this theory.

4. A new interpretation

William Henry Bragg, Cavendish Professor of Physics at the University of Leeds, tried to explain the effect observed by Friedrich, Knipping and Laue by his corpuscular hypothesis of X-rays. This approach, however, was soon abandoned and he, jointly with his son, the physicist William Lawrence Bragg from the University of Cambridge, adopted a wave conception of X-rays and came to the conclusion that Laue's was indeed a diffraction effect.

W.L. Bragg, however, suggested that Laue's explanation of the diffraction pattern was incorrect and unnecessarily complex. In order to explain the place of the spots, Laue was indeed forced to assume that only a few definite wavelengths are present in the incident beam. W.L. Bragg assumed instead that the X-rays beam is composed of a continuous range of wavelengths and that the diffraction patterns are due to an effect of reflection of the beam upon the crystal planes

After having observed that the points of a space lattice may be arranged in a series of planes, parallel and equidistant from each other (the simplest ones being the cleavage planes of the crystal), W.L. Bragg regarded "each interference maximum as due to the reflection of the X-rays in the systems of this plane" (Bragg 1913).

For a given wavelengths, the condition for the maxima was given by the law (eventually known as Bragg law)

$$n\lambda = 2d \sin \vartheta$$

where n is an integer, ϑ is the glancing angle, and d is the spacing of the planes.

Considered thus, W.L. Bragg wrote, "the crystal actually 'manufactures' light of definite wavelengths, much as ... a diffraction grating does" (Bragg 1913).

W.L. Bragg applied this new way of interpreting the diffraction pattern (that does not contradict Laue's theory) to the zinc blende photographs analyzed by Laue. He assumed, following a suggestion by the chemist William Pope (Cambridge), that the zinc blende was a face centered cubic structure instead of, as assumed by Laue, a simple cubic structure (this assumption had indeed led Laue to estimate the cell size of the cubic lattice as smaller than $\sqrt[3]{4}$ and forced him to assume that only some wavelengths were present in the X-rays beam).

By this assumption, Bragg found that all the spots can be readily explained, also if other crystals were considered (figure 3).

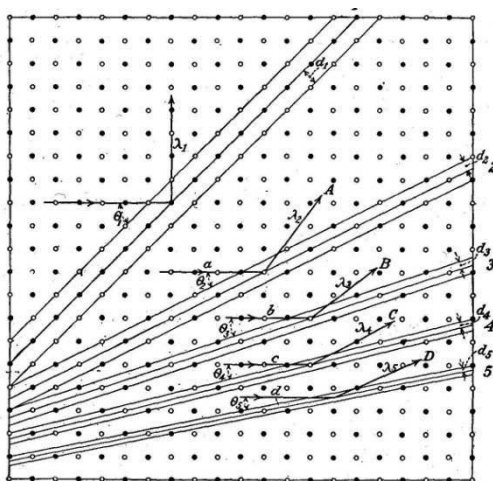

Figure 3. Schematic representation of the reflection by a crystal of rock salt (NaCl) of an heterochromatic X-rays incident beam (Richtmyer, F.K. (1934). *Introduction to modern physics*, 2nd edition, McGraw-Hill, New York)

On December 1912, W.L. Bragg carried out an experiment on a slip of mica and observed the specular reflection of the surface of the crystal.

This experiment opened up a period of close collaboration between father and son which is perhaps unique in the history of the science, both for its lasting intensity and the importance of the resulting discoveries.

In January 1913 W.H. Bragg succeeded in detecting the reflected rays with a ionization chamber, and two months later developed the first X-rays spectrometer, the instruments which for decades to come was the main tool for crystal structure analysis (it is an apparatus similar to an optical spectrometer in arrangement, an ionization chamber taking the place of a telescope) (Bragg and Bragg 1913).

By this new instrument, the Braggs measured the spectral distribution of the X-rays of their tube by using anticathodes of platinum, osmium, etc, and identified the K and L characteristic radiations discovered by Barkla in 1911. These radiations, could be recognized also in the reflection from the faces of crystal.

Since April 1913 the focus of Bragg's work changed from the study of X-rays to the study of the structure of a crystal. By using the monochromatic K and L lines and measuring the angles at which these lines appeared after being reflected by the crystal, they could use the Bragg law on the reverse, that is to determine d and thus the structure of the crystal. By this method, several structures were confirmed and others discovered. For example, in July 1913 the Braggs studied the structure of diamond and discovered the tetrahedral arrangement of carbon atoms. At the end of the same year the crystal structure analysis became a standard procedure.

The importance, and also the history, of the discovery of X-rays diffraction is illustrated by the three Nobel prizes in Physics awarded between 1914 and 1917 for contributions within this field: to Laue in 1914 "for his discovery of the diffraction of X-rays by crystals", to the Braggs in 1915 "for their services in the analysis of crystal structure by means of X-rays", and to Barkla in 1917 "for his discovery of the characteristic Röntgen radiation of the elements".

Only a Nobel is oddly missing, notwithstanding a large number of nominations: Sommerfeld's one (Crawford 2002).

5. From X-rays spectroscopy to the DNA

In the period 1915-1920, following the fundamental Bragg's accomplishments, the X-rays spectroscopy laid the foundations for its successive development. Among the main results of this period are: accurate measurements of the X-rays wavelengths; analysis of large numbers of simple crystals by the new technique; discovery of a method to reliably measure the intensity of the reflected X-rays; measurement of Debye effect (that is the influence of temperature on the magnitude of X-rays reflection); development of Darwin's formulas for the intensity of X-rays reflection in crystals; understanding that each crystal diffraction corresponds to a Fourier component of the density of crystal; availability of a new set of crystal substances by the powder method, that in turn opens the way to the analysis of microcrystalline materials (Ewald 1962).

In the 1920s the X-rays spectroscopy becomes a quantitative science and is applied to increasingly complex structures, e.g. organic crystals. By studying naphthalene and anthracene W.L. Bragg showed in 1922 that the shapes of these molecules expected by organic chemistry fit well with actual measurements. In 1929

Kathleen Lonsdale discovered the structure of benzene and established that the derivatives of benzene are flat thereby putting an end to the mystery of aromatic hydrocarbons bonds. In 1925 the 2D Fourier analysis for crystal analysis is developed. In 1935 W.L. Patterson published a significant paper, introducing an important theoretical tool, the Patterson function, into the X-rays crystal structure analysis (Ewald 1962).

In late 1930s the first studies on biological macromolecules are pursued, and to 1930 are dated the first photographs of diffraction patterns from DNA fibres, obtained by Florence Bell, at the William Astbury Laboratory in Leeds. A new important photograph of DNA was taken in 1951, still at Astbury Laboratory, by Elwyn Beighton (Hall 2014).

However, the understanding of DNA structure required a theoretical discovery made in the same year by Linus Pauling and Robert Corey: the α -helix structure of proteins. In 1953 Pauling himself attempted to understand the DNA structure by this novel idea. His triple-helical model turned out, however, to be wrong (Pauling and Corey 1953).

The correct, *double helix*, model was suggested shortly later, still in 1953, by James Watson and Francis Crick with the help of the biophysicist Maurice Wilkins (Watson and Crick 1953; Wilkins, Stokes and Wilson 1953). This model was confirmed, and perhaps inspired, by an X-rays diffraction photograph of DNA obtained one year earlier (1952) by Raymond Gosling under Rosalind Franklin supervision at King's College of London (Franklin and Gosling 1953).

For this discovery Crick, Watson and Wilkins were awarded the Nobel Prize in Medicine 1962. Franklin untimely died in 1958 and was therefore ineligible for nomination to the Nobel Prize.

Her name, however, has lived on in history thanks to "Photo 51": a lasting symbol of the X-rays spectroscopy triumph (figure 4).



Figure 4. Gosling and Franklin's X-rays diffraction photograph of DNA (Photo 51) (source: https://askabiologist.asu.edu/Rosalind_Franklin-DNA).

6. Historical (and educational) conclusions

The above account shows that the discovery of X-rays diffraction was the final outcome of a lengthy process requiring a number of conditions: the success of the wave theory of X-rays mainly through Barkla's discovery of the fluorescence rays; the reliable estimate of X-rays wavelength; the emergence of an interest toward the crystal optics and the crystal lattice structure; and, finally, the development of an experimental expertise on X-rays and the commercial availability of fairly powerful X-rays tubes. All these conditions were met by 1912, particularly at the Sommerfeld's Department in Munich, where the scientific climate was favorable to Laue's discovery.

However, even if the search of X-rays diffraction was in the air in Munich, Laue was the one who had the idea that Nature gave us the right tool, that is a tool of resolving power high enough to diffract the X-rays, the crystal. Röntgen and others had looked for the diffraction by crystals, but to no avail. Laue succeeded where others had failed because he understood that the crystal may behave as a diffraction grating for X-rays. He knew what to look for and how to find it.

To make Laue's discovery a powerful experimental method, however, a new instrument was necessary, W.H. Bragg's X-rays spectrometer, and another fundamental idea was required, that is W.L. Bragg's idea that the diffraction might be seen as the internal reflection by the crystal planes.

These are all historiographical conclusions. However, these conclusions have also an educational significance. This case study shows indeed the presence of a number of the characteristics features of science (Matthews 2012).

The emergence in Munich of the discovery of X-rays diffraction emphasizes the social and cultural embeddedness of scientific knowledge. The way in which a crystal changes, in Laue's hands, into something new and unprecedented, that is a tool to observe the diffraction of X-rays, highlights other crucial features of science: the creative and imaginative nature of scientific knowledge, and the experimentation, or the Galilean importance of interfering with nature.

Lawrence Bragg's ways of looking at Laue's data shows the importance of idealization, or the fact that nature laws may not be always obvious in the immediate experience.

A final conclusion is in order. The discovery of X-rays diffraction, in turn, gave rise to the birth of a new field of science, the X-rays spectroscopy, that eventually led to one of the most significant discoveries of the 20th Century, the double helix model of the chromosome, thereby showing the role of models, and of their ubiquity in the history and current practice of science.

References

- Barkla, C.G. (1906). Polarization in Secondary Röntgen Radiation, *Proc. Roy. Soc. London* **77A**, 247–255.
- Barkla, C.G. (1908). Note on X-rays and scattered X-rays, *Phil. Mag.* **15**, 288-296.
- Bragg, W.H. Letter to Rutherford, E. (5 December 1912). Rutherford Papers, Cambridge University Library.
- Bragg, W.H. and Bragg, W.L. (1913). The Reflection of X-rays by Crystals, *Proc. Roy. Soc. London* **88A**, 428–438.
- Bragg, W.L. (1913). The diffraction of short electromagnetic waves by a crystal, *Proc. Cambridge Phil. Soc.* **17**, 43–57.
- Crawford, E. (Ed.) (2002). *The Nobel Population: 1901-1950*, Universal Academy Press, Tokyo, Japan.
- De Hosson, C. and Schneeberger, P. (2011). Recent directions in the interaction between research into didactics and the history of science, *Recherches en didactique des sciences et des technologies* **3**, 1-14.
- Ewald, P.P. (Ed.) (1962). *Fifty years of X-ray diffraction*, N.V.A. Oosthoek's Uitgeversmaatschappij, Utrecht. See also: <http://www.iucr.org/publ/50yearsofxraydiffraction>
- Franklin, R.E. and Gosling, R. (1953). Molecular configuration in sodium thymonucleate, *Nature* **171**, 740-741.
- Friedrich, W., Knipping, P and Laue, M.V. (1912). Interferenz-Erscheinungen bei Röntgenstrahlen, *Sitzungsberichte der Königlich Bayerischen Akademie der Wissenschaften. Mathematisch-physikalische Klasse*, 303-322.
- Hall, K.T. (2014). *The man in the monkeynut coat: William Astbury and the forgotten road to the double-helix*, Oxford University Press, Oxford.
- Laue M v (1915) Concerning the detection of X-ray interferences. Nobel lecture, November 12, 1915. In Nobel Foundation (1967), 347-355
- Leone, M (2014). History of physics as a tool to detect the conceptual difficulties experienced by students: the case of simple electric circuits in primary education, *Science & Education* **23**, 923-53.
- Matthews, M.R. (1994). *Science teaching: The role of history and philosophy of science*, Routledge, New York.
- Matthews, M.R. (2012). Changing the focus: from Nature of Science (NOS) to Features of Science (FOS). In Khine M:S. (Ed.), *Advances in Nature of Science Research*. Dordrecht, The Netherlands: Springer.
- Pauling, L. and Corey, R.B. (1953). Compound helical configurations of polypeptide chains: structure of proteins of the α -keratin type, *Nature* **171**, 346–347.
- Robotti, N (2012). The discovery of X-ray diffraction, *Rendiconti Lincei. Scienze Fisiche e Naturali* **24**, 22-40.
- Röntgen, W.C. (1895). Über eine neue Art von Strahlen, *Sitzungsberichte der Physik.-med. Gesellschaft zu Würzburg*, 132-141; *Annalen der Physik und Chemie* **64**, 1-11; *Nature* **53**, 274.
- Schwartz, R. and Lederman, N. (2008). What scientists say: scientists views of Nature of Science and relation to science context , *International Journal of Science Education* **30**, 727-771.
- Sommerfeld, A. (1912). Über die Beugung der Röntgenstrahlen, *Ann Physik* **38**, 473-506.
- Watson, J.D. and Crick, F.H.C. (1953). Molecular structure of nuclei acids, *Nature* **171**, 737–738.
- Wilkins, M.H.F., Stokes, A.R. and Wilson, H.R. (1953). Molecular structure of nucleic acids: molecular structure of deoxypentose nucleic acids, *Nature* **171**, 738–740.

Affiliation and address information

Francesco Guerra
Department of Physics
Sapienza University of Rome and INFN section of Rome
Piazzale A. Moro, 001.. Rome, Italy
e-mail: Francesco.guerra@roma.infn.it

Matteo Leone
Department of Philosophy and Educational Sciences
University of Turin
Via Gaudenzio Ferrari 9, I-10124 Turin, Italy
Campus of Savigliano, Via Garibaldi 6, I-12038 Savigliano (CN), Italy
e-mail: matteo.leone@unito.it

Nadia Robotti
Department of Physics
University of Genova and INFN section of Genova
Via Dodecaneso 33, I-16126 Genova, Italy
e-mail: robotti@fisica.unige.it

A Teaching Proposal on Electrostatics Based on the History of Science through the Reading of Historical Texts and Argumentative Discussions

Marina Castells, Aikaterini Konstantinidou, Josep M. Cerveró
Universitat de Barcelona

Abstract

Researches on electrostatics' conceptions found that students have ideas and conceptions that disagree with the scientific models and that might explain students' learning difficulties. To favour the change of student's ideas and conceptions, a teaching sequence that relies on a historical study of electrostatics is proposed. It begins with an exploration of electrostatics phenomena that students would do with everyday materials. About these phenomena they must draw their own explanations that will be shared and discussed in the class. The teacher will collect and summarize the ideas and explanations which are nearer the history of science. A brief history of electrostatics is introduced then, and some texts from scientists are used in an activity role-play-debate type in which the "supporters of a single fluid" and "supporters of two fluids" have to present arguments for their model and/or against the other model to explain the phenomena observed in the exploration phase. At following, students will read texts related to science applications, the main aim of this activity is to relate electrostatics phenomena with current electricity. The first text explains how Franklin understood the nature of the lightning and the lightning rod and the second is a chapter of a roman about one historical episode situated in the Barcelona of XVIII. Students will use the historical models of one and of two fluids to explain these two phenomena, and will compare them with the scientific explanation of the "accepted" science of nowadays introduced by the teacher. With this type of teaching proposal, conceptual aspect of electrostatics will be learnt, but also they will learn about the nature and history of science and culture, as well as about argumentation.

Keywords

Electrostatics; Secondary Education; Pre-service Primary Education; Argumentation; History of Science; Science Communication

1. Introduction

History of Science and Science Education

The History of Science (HS) has been fundamental for the development of Science Education to which it contributes in several aspects like:

- the theoretical bases of Science Education by its relationship with the New Philosophy of Science and the Sociology of Science (Bachelard, 1938; Duschl, 1990; Izquierdo & Arduiz, 2003);
- the comprehension about the Nature of Science (NOS) (as it is built, legitimated, and communicated, actions that require argumentation and rhetoric in a central place) (Holton, 1978; Gross, 1996; Pera & Shea, 1991);
- epistemologies of nowadays consider that the Science advances by solving problems and decision taking, activities carried on by humans (Laudan, 1978; Giere, 1992);
- the inspiration for new science teaching approaches of the curricula and for the design of specific Teaching Sequences (TS) with HS as a possible context, or a source for teaching approaches and learning activities in science classes (Matthews, 1994a,b; Holton, 1978; Heering et al., 2013);
- to bring a valuable information to help teachers in the comprehension of the science ideas & conceptions of students, and so, of the difficulties of some specific conceptual changes of students; as well information about common sense reasoning and arguments students may given (Bachelard, 1938; Benseghir & Closset, 1996; Viennot, 1996; Seraglou et al., 1998; Castells & Konstantinidou, 2008);
- specific approaches, ideas, and resources for the Teacher Training courses (Arons 1988; Furió & Guisasola, 1998; Dawkins and Glatthorn, 1998).

There is agreement among the experts about the NOS (McComas, 1998; Millar & Osborne, 1998) being part of the science scholar curricula, and this idea reinforces our hypothesis that a TS based on aspects of HS, and students' debates about historical or popularization texts related to specific topics of science may be a good proposal to teach science and about science, and also about history and culture.

Researches about students' conceptions in science

Researches about students' conceptions in science, that have been carried on for more than 30 years) (Driver et al., 1994; Pfund & Duit, 1998; Duit, 2009) confirms the difference between the science ideas and conceptions of students and the scientific knowledge agreed in the community of scientists. Quite often students' ideas are incompatible with physics views (Saltiel & Malgrange, 1980; Duit et al., 2007). This also holds true for students' 'more general patterns of thinking and reasoning' (Arons, 1988; 1997; Viennot, 1996; Viennot, 2014). Many researchers and experts on Science Education think that those differences may cause many of the difficulties students have in their learning about some topics. The need of conceptual change is accepted by experts but also there is agreement about how difficulty this change may be in some cases, as it had happened in the development of science (Bachelard, 1938; McCloskey 1983).

Some experts agree that it is very difficult that students will discover the scientific knowledge to interpret the world on their own, and so, the school has to bring this scientific way to see the world to them (Guidoni, 1985; Leach and Scott, 2002; Ogborn, 1996) and the teaching has to be sensitive to the need to guide these changes and to engage students in the process of learning science. One way to help students in this process is to bring the scientific knowledge through the reading of fragments of historical texts about science or from popularization books about which debates may be carried on in the science classes (Lochhead & Dufresne, 1989); but also by other ways, as through historical reconstructions; study of historical cases; historical narratives; or performing historical experiments, or activities based on historical controversies. The reading and work on biographies can be also very useful and engaging for the students and, so on. In fact, the use of HS is not new in SE although perhaps not enough research have been done about the students' learning based on HS.

Students' misconceptions related to electrostatics

Researches on students' conceptions on electrostatics found that students have ideas and concepts very different from the ones of the scientific models to interpret these phenomena (Benseghir & Closet, 1996; Furió et al., 2004). Among other, students consider electrostatics phenomena without any relation with the phenomena linked to current electricity and so, for them is very difficult to understand electric current based on the model of charges. (Arons, 1997; Soreoglou, 1998; Criado & Garcia-Carmona, 2009). Some researchers and teachers (Arons, 1997; Harrington, 1999; Knight, 2004) found students familiar with the terminology used in electricity and magnetism but that the familiarity with the terms doesn't mean that they have a physics understanding associated to these terms. Researches on students' misconceptions consider that those in electricity and magnetism are at least as widespread and significant, perhaps more, than in mechanics.

We collect here some alternative ideas on Electrostatics, mainly from Knight (2000), and that many researchers coincide to attribute to students and which ones we summarize at following:

- Students don't distinguish clearly the electric attractions from the magnetic ones. Some of them neither from the gravitatory ones. Some students say that the north magnetic pole repulses the positive electric charges. That means they may have a big confusion between attractions and repulsions that have to them a very different nature.
- Many students think that the isolated materials cannot be charged. Part of this difficulty is that students do not differentiate between *charge* and *motion of charge* (current). Because the current will not flow through an insulator (no *motion* of charge) students erroneously conclude that the insulator cannot be charged and they don't distinguish between an object (insulator/conductor) and its state of charge (charged or neutral).
- Some students think about the charge as an object more than a property of the matter. Or some may think a charge is a substance that can be painted on a matter.
- Relating everyday phenomena some students think that the lightning rod are useful to collect the lightnings and because of this, they don't arrive to the houses.

- Some students think that “neutral” is a third type of charge.
- Students, in general, don’t recognize the charge conservation.
- They think there is a fundamental reason which do that the electrons has to be negative.
- Some students think that an object positively charged has received an excess of protons and that the protons can move as the electrons do into many materials.
- Students don’t have a good comprehension of the structure and of atomically properties of the solid materials. They don’t know what does neutral, not neutral or charged means at an atomic level means.

Our research about students’ conceptions on electrostatics

Some pre-service primary education teachers in the University of Barcelona have answered some questions about electricity phenomena, some of these about electrostatics. These students didn’t have any specific scientific or technologic background. The results of the analysis of their answers mainly agree with the findings of other researches edited in journals. We will not comment here about theses answers’ students because the extension of this paper and that coincidence with other findings.

2. The teaching sequence

The Framework

Our perspective is near to the *Didaktik* tradition in Germany, to the 'Didactique Transposition' in French and Didactic Approach in some southern European countries, as Italy. I think the meaning we give in Catalonia to the word *Didàctica* is not very far from these German and French traditions. The meaning of *Didaktik* concerns the analytical process of transposition (of transformation) of human knowledge like domain-specific knowledge into knowledge for schooling. In this process, the *content structure* of a certain domain (e.g., Physics) has to be transformed into a *content structure for instruction*. The two structures are substantially different. We have below a summary adapted from Duit et al, 2007 of the process of *construction of the content structure and key ideas for instruction*.

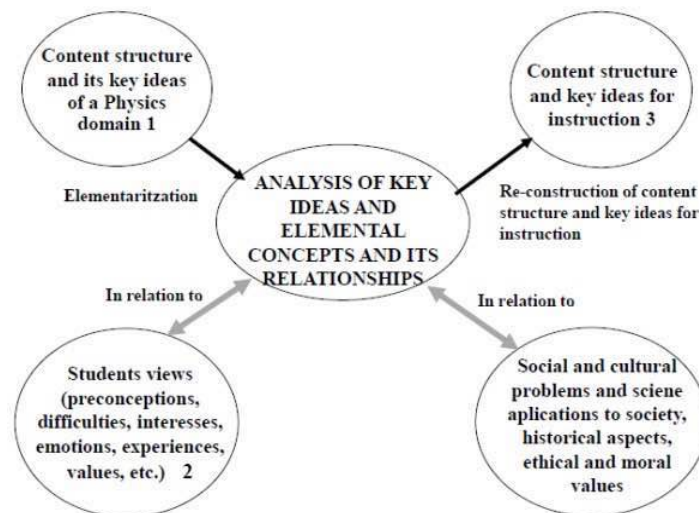

Figure 1. Didactical Reconstruction (Adapted from Duit et al. 2007)

In this TS we will use some historical texts or popularization texts because they can be instructive and illuminating of the actual historical ups and downs and controversies in the development of Electricity.

Many textbooks, after forming the concept of “charge” and examining electrostatics phenomena in the context of frictional electricity, make a discontinuous jump to current electricity by simple asserting that electric circuits containing batteries involve “charge in motion” and begin to talk of electric current. To most students, however, it is far from obvious that the current and the “charge” that has been “caused” by friction are of the same nature. And this is a big problem in the Electricity comprehension (Arons, 1997). This is not a trivial matter, and had been a serious debate about it in the scientific community late on the 1830s

(Castells, 2000). Faraday gave many attention on this problem. In the *Electrical Researches* [Faraday (1965)], there is a paper, dated on 1833 and titled “Identity of Electricities Derived from Different Sources,” in which Faraday describes several experiments related to “different electricities”. These “electricities” were referred by him as voltaic, common (frictional), magneto (from electromagnetic induction), thermo (from thermocouple), and animal electricity from some fishes. Through their experiments Faraday demonstrated that each of these types produces identical effects, and arrive to the following conclusion that electricity, whatever may be its source, is identical in its nature (Faraday, 1830s).

The aims of the Teaching Sequence

Our proposal focuses on the teaching-learning the topic of electrostatics for a secondary school, which is mainly inspired by or is fitting with the history of this part of the Electricity, but also taking account of the results of researches made on students’ science conceptions related to this topics other experts have done (Soroglou et al., 2004). Our *aim* is not giving to students a detailed history of the Electrostatics, but some aspects of the historical development of this topic with the support of some texts (historical or of popularization ones) about which the students may argue. The main idea that we want students to understand is that there are opposite theories or conceptualizations and interpretations of the same facts in a period of time. In our proposal we try also to relate the history of electrostatics with the students’ interpretations of some qualitative experiments carried on by them in the classes or at home.

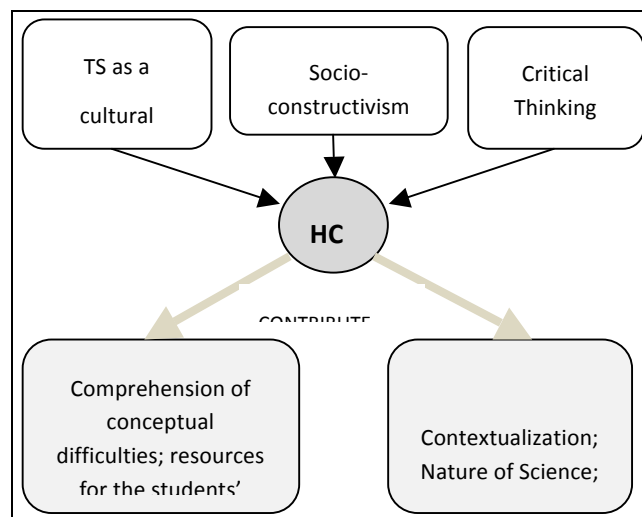

Figure 2. Teaching Sequence

In this way, our approach fits with a teaching sequence that incorporates some of the nowadays agreements in science education, among other which consider in science classes we should try to answer questions as: What the scientists know? Which ideas, concepts, and models we select to learn in our science classes? Why? Which are the most relevant facts which interpretation has lead to the specific ideas or models? Or, how the scientists arrived to a specific explanatory model? Why we accept or belief these (.....)? How does an idea, concept, ..., is related to other ones? The TS agrees with the nowadays Science Education recommendation of contextualization of the scientific knowledge for the instruction (Gilbert et al., 2010).

We participate of the Socioconstructivism (Vygotsky, 1978) perspective, and we are also interested to help the development of the Critical Thinking of our students in the meaning of Arons (1997) and considering also aspects of values. (See Figure 2)

The sketch of the Teaching Sequence about Electrostatics

From the results of our research about students’ conceptions on electrostatics, from our study of the historical development of electricity (Castells, 1996), from the reading of proposals that Science Education and HC experts have done (among other, Arons, 1978; Furió et al., 2004; Seroglou et al., 1998) and the agreements nowadays exists between experts in science teaching we will sketch a proposal of a Electrostatics’ TS and contextualized on the HS of this part of the electricity and also on a periode of history in a specific place and cultural context.

I. Exploration of electrostatic phenomena in peer-groups.

- II. **Brief history of electrostatics** is introduced, and some *readings from o related to the HC are proposed* to students.
- III. **Debates and arguments in the class using ancient models (of one or two fluids) to interpret the electrostatics phenomena.**
- IV. **New phenomena and instruments** are introduced to be explored and interpreted with the same models.
- V. **Reading texts about applications of electrostatics and related to HS** (the discovery of the Lightning rod by Franklin) and HS related to our country, in particular to Barcelona and an ancient Academy from 1764.
- VI. **Introduction of the accepted explanatory model of electrostatics by the teacher and by students.**
- VII. **Students in peer-group compare one of the historical models with the nowadays model** and argue in favour or against each one.
- VIII. **A more modern application using the Van der Graaf generator to produce electrostatics effects is experimented.**

At following we will detail more about the main relevant elements of the TS proposed.

I. Exploracion of Electrostatics' phenomena

a) Exploration of electrostatic phenomena of attraction and repulsion with everyday materials in peer-group is performed:

- *Attraction and repulsion of bodies of small weight* (water, pendulum, small pieces of paper, of ...) by electrified objects *by friction* (pen, globes, bar of glass ...) with several different materials (silk, cotton, hear, wool...)
- ASKING
 - What happen?
 - Why do you think that happen?
 - How do you can explain this?
 - With which other phenomena do you relate them?

If students don't have been aware of the repulsion with the same objects once they are put in contact with the small bodies, the teacher has to ask to students to put attention on this phenomenon of repulsion.

b) Exploration about conductors and isolators

- *Exploration with conductors* (metal bars, ...) and *with isolator materials* (plastic bar, ...) to see if there are differences.
- ASKING
 - What happen?
 - Why do you think that happen?
 - How do you can explain this?
 - With which other phenomena do you relate them?

c) Explicitation and argumentation about the interpretative models

Every group presents their interpretations of the phenomena and a whole group class about the different interpretations is then performed.

The teacher guide the whole class debate and she/he will try to find some interpretations similar to the historical interpretative models of XVIII Century, in fact, the *theory of one fluid* (Franklin; Aepinus and others) or the one of *two fluids* (Symmer; Coulomb and others).

II. Brief history of electrostatics and some readings from o related to the HS

The teachers elaborate the summary of the history of electrostatics using relevant bibliography (books and papers they can found in the University of Barcelona or in other libraries, as in the library of 'Real Acadèmia de Ciències i Arts' in Barcelona). Some references are included in this paper.

Students have to read two texts about two ancient interpretative models:

Text 1: One fragment of EXPERIMENTS AND OBSERVATION ON ELECTRICITY MADE AT PHILADELPHIA in AMERICA, BY M. BENJAMIN FRANKLIN, L. L. D. and F.R.S, LONDON: D. Henry & F. Newbery, 1749, in which Franklin defends the theory of one fluid to interpret the electrostatic phenomena, and

Text 2: A fragment of the Chapter 2 of the book from Einstein A. & Infeld, L. (1939) *The Evolution of the Physics*, in which the theory of the two fluids is summarized by Einstein and Infeld¹.

To elaborate the TEXT 1 we have used a French translation from 1749. In concrete, our copy is from a book which belonged to Francesc Salvà Campillo, a Catalan scientist in the XVIII Century (about which we will comment below) that we have translated to Catalan language for our students in Barcelona. As the title says in this volume, there are also some letters and papers on other philosophical issues. We choice the LETTERS ON ELECTRICITY from M. Benjamin Franklin of Philadelphia (America) to Peter Collinson, from the Royale Society of London.

The Letter I is from 1749, and it is the one we have used in our Teaching Unit.

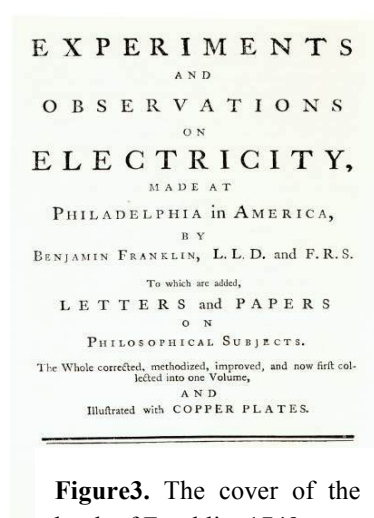

Figure3. The cover of the book of Franklin, 1749

OPINIONS AND CONJECTURES

Concerning the Properties and Effects of the Electrical Matter, and the Means of preserving Buildings, Ships, &c. from Lightning, arising from Experiments and Observations made at Philadelphia, 1749. — Golden-Fish — Extraction of Effluvial Virtues by Electricity impracticable.

1. The electrical matter consists of particles extremely subtile, since it can permeate common matter, even the densest metals, with such ease and freedom as not to receive any perceptible resistance.

2. If any one should doubt whether the electrical matter passes through the substance of bodies, or only over and along their surfaces, a shock from an electrified large glass jar, taken through his own body, will probably convince him.

3. Electrical matter differs from common matter in this, that the parts of the latter mutually attract, those of the former mutually repel each other. Hence the appearing divergence in a stream of electrified effluvia.

4. But, though the particles of electrical matter do repel each other, they are strongly attracted by all other matter^{2*}: this has to be understood from which are susceptible of this.

5. From these three things, the extreme subtilty of the electrical matter, the mutual repulsion of its parts and the strong attraction between them and other matter, arises this effect, that, when a quantity of electrical matter is applied to a mass of common matter, of any bigness or length, within our observation (which hat not already got its quantity), it is immediately and equally diffused through the whole.

6. Thus, common matter is a kind of sponge to the electrical fluid. And as a sponge would receive no water, if the parts of water were not smaller than the pores of the sponge; and even then but slowly, if there were not a mutual attraction between those parts and the parts of the sponge; and would still imbibe it faster, if the mutual attraction among the parts of the water did not impede, some force being required to separate them; and fastest, if, instead of attraction, there were a mutual repulsion among those parts, which would act in conjunction with the attraction of the sponge; so is the case between the electrical and common matter.

¹ We don't copy here this text 2 because there is not enough space in this paper and because the book is very easy to drawn down from Internet.

² See the ingenious *Essays on Electricity*, in the Transactions Phil, by Mr. Elliot.

7. But in common matter there is (generally) as much of the electrical, as it will contain within its substance. If more is added, it lies without upon the surface, and forms what we call an electrical atmosphere; and then the body is said to be electrified.

.....

18. These explanations of the power and operation of points, when they first occurred to me, and while they first floated in my mind, appeared perfectly satisfactory; but now I have written them, and considered them more closely, I must own I have some doubts about them; yet, as I have at present nothing better to offer in their stead, I do not cross them out; for, even a bad solution read, and its faults discovered, has often given rise to a good one, in the mind of an ingenious reader.

19. Nor is it of much importance to us to know the manner in which nature executes her laws; it is enough if we know the laws themselves. It is of real use to know that China left in the air unsupported will fall and break; but *how* it comes to fall, and *why* it breaks, are matters of speculation. It is a pleasure indeed to know them, but we can preserve our China without it.

III. Debates and arguments in the class.

Students are divided in two groups: “supporters of a single electric fluid” and “supporters of two electric fluids” and a *roll play activity* is performed. Both groups have to give arguments to defend their model and to refute the other group’s model. It is important not only to take a position but also to give arguments that other students may refute.

IV. New experiments and instruments in Electrostatics

a) Using the electrofor and the electroscope.

Basically the process is the same as have been done with the other explorations and interpretations. The activity focuses on the *storage up of electricity* with the *electrofor* and on the detection of the electricity with the *electroscope*. The instruments will be also useful to differentiate between the concepts of *electrization by contact* and *electrization by influence*.

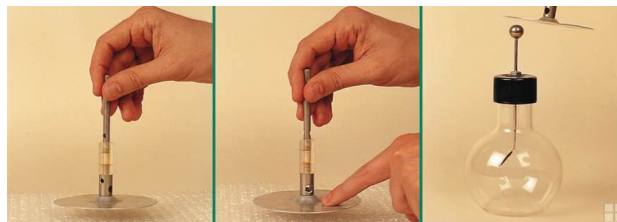

Figure 5. Electroscop and Electrofor

b) Exploration and interpretation with the Leyden jar

It is convenient to build a *Leyden jar* in the class or at home and it may be used as another instrument that can store up “electric fluid” or electrical charge in the modern language and that had been a very important instrument in the historical development of electrostatics. Students could read some fragments of any ancient book about the Leyden jar or, particularly, in the book of Franklin in which there is a summary of the history of Electricity in which the Leyden jar is deeply commented. The instrument may be presented at the first level as an instrument that can store up “electric fluid”, if the concept of *condenser* is not introduced yet to students. The experiments performed will be described and interpreted by students using both models of one or of two fluids following the same methodology of the other explorations and interpretations but now interchanging their models.

c) Exploration of conduction of electricity to big distances.

Exploration and interpretation of phenomena of *electricity conduction* through conductors is carried on. The electrofor may be used as storage of electricity, and better if the Leyden jar is used because its great historical relevance.

V. Reading texts about applications of Electrostatics and exploring ideas about phenomena

a) Exploration of the students’ conceptions about the Lightning and the Lightning rod.

This part of the TS could have been done in several ways. One could be coming from the reading of a book of popularization about Franklin and some of his experiments and ideas. At the end of the activity the teacher asks some questions to the students which they answer in pairs. The book is *Vida de Benjamin Franklin*³. The proposed fragments to discuss in class are the fragment which is a description of the experiments that Franklin had performed to understand the electric nature of the lightning and how to construct an instrument to protect the buildings from the lightning.

We suggest students may extend their readings at home about the *life and experiments of Franklin* with other parts of this book. The book is part of a collection named LIFE OF GREAT MEN edited in Barcelona many years ago. The book doesn't present only Franklin as a scientist, but also the man with his values and social actions he did, and his life as politician too, acting very strong in favour of the independence of his country from U.K. We think this book should be a recommendable reading for our students nowadays.

b) Exploring another application of Electrostatic in a specific cultural context and period of time. The electric telegraph (XVIII century)

Individual reading, peer-group discussion and whole group discussion and synthesis.

The students will read a text about a new application of Electrostatics: the case of *the electric telegraph* by Salvà Campillo, from a novel from Riera (2005)⁴ based on historical facts in Barcelona at the XVIII Century. This roman can be an interesting resource to teach about science, nature of science, as well as about history and culture of a key episode in the development of science in a specific social and political context, the Catalan one, not many years after the Succession War (1714).

The chapter 4 is related to Electrostatics, in which it is presented the historical case of Salvà Campillo performing an exhibition in front of the King of Spain (Charles IV) and his family with the telegraph he had invented. In this telegraph several Leyden Jars with the electric fluid stored were connected to conductors and then the messages could be sending through these conductors from one place to another.

The European context in which many Science Academies and other Scientific Societies were created could be a larger context of the TS. In fact, the plot of the novel is related to some academics of the 'Real Academia de Ciencias y Artes' (1764). Two main characters are: Francesc Salvà Campillo (1751-1828) (which worked on topics of Physics and Medicine) (1751-1828) and Antoni Martí Franquès (1750-1832) (which worked on topics of Chemistry and Botany).

There are several didactical strategies teachers can use to work in the classes with this text.



Figure 7. Cover of the book *The town of the change* (S. Riera Tuèbols) 2001

³ Jorge Santelmo (1934) *Vida de Benjamin Franklin*, Barcelona: Seix y Barral Eds. Due to lack of space this text is not included here.

⁴ Santiago Riera Tuèbols (2005) *La ciutat del canvi* (The town of the change) which is a novel based on historical facts in Barcelona at the XVIII Century (chapter 5, pp 53-67).

VI. Introduction of the scientific accepted explanatory model by the teacher and by students looking for information in books or Internet, of *Electrostatics* of nowadays.

VII. Students in peer-group compare one of the historical models with the nowadays model. They could look for the advantageous and the inconvenient of the models through argumentation. Perhaps they may do new observations and interpretations. Every *peer-group* writes a *summary* of these. These *summaries* will be shared in the whole class guided by the teacher trough debates or agreements among all the groups.

VIII. A more modern application

Conduction of electricity through conductors (exploration, interpretation, experimentation) and sparks production with the *Van der Graff*.



These observations can help students to understand the lightning and to change their conception about the nature of electrostatics and of electricity of current, which is the same. With the Van der Graff it is possible to produce sparks very far from the generator, and so students can relate the electricity by friction and the electricity of current.

To conclude we can say that with this type of teaching proposal, students will learn conceptual aspects of electrostatics as well about experiments' interpretation, but also they will learn about the nature and history of science and culture, as well as about argumentation.

Acknowledgements

The present research and proposal was supported by ARCE 2013-UB (Agrupació de Recerca en Ciències de l'Educació, Universitat de Barcelona) to GRIEC-UB (Grup de recerca en Ciències Education); and by MEC Project N° EDU-2012-38022-C02-02 (Coor. C. Màrquez UAB, LIEC-UAB, Llenguatge i Ensenyament de les Ciències)

References

- Arons, A. B. (1988) Historical and Philosophical perspectives attainable in introductory physics courses. *Educational Philosophy and Theory*, 20 (2), 12-23
- Arons, A. B. (1997) *Teaching Introductory Physics*. EEUU: John Wiley and Sons
- Bachelard, G. (1938) *La formation de l'esprit scientifique*, Paris: Vrin
- Benseghir, A. & Closset, J. L. (1996) The electrostatics electrokinetics transition: historical educational difficulties. *International Journal of Science Education*, 18 (2), pp. 179-191
- Castells, M. (2000) Aplicació del model de Laudan al canvi científic que representa la unificació a nivell conceptual de l'electricitat estàtica i de l'electricitat voltaica. In: Batlló, J., de la Fuente, P; Puig, R. V *Trobades d'Història de la Ciència i de la Tècnica*, Tortosa: SCHCT- IEC. Pp: 315 - 327
- Castells, M. & Konstaninidou, A. (2008) The use of Galileo's Dialogue to obtain interesting questions and arguments to convince students in the Physics' classes. A: *Styles of thinking in Science and Technology*. The Third ICESHS Austrian Academy of Sciences, Vienna pp: 822 - 833
- Chevellard, Y. (1990) *The Transposition Didactique*. Paris: PUF
- Clough, M. P. (2006) Learner's reponses to the demands of conceptual change: considerations for effective nature of science instruction. *Science & Education*, 15 (4): 465-494
- Conant, J. B. and Nash, K. K (eds) (1957) *Harvard Case Histories in Experimental Science*, 2 vols., Cambridge: Harvard, University Press
- Criado, A.M; Garcia-Carmona, (2009) Prospective Teachers' Difficulties Interpreting Elementary Phenomena of Electrostatic Interaccions: Indicators of the status of their intuitive ideas. *International Journal of Science Education* 36 (6) 769-805

- Dawkins, K. R.; Glatthorn, A. A. (1998) Using historical case studies in biology to explore the nature of science: A professional development program for high school teachers: McComas, W.F. (ed) *The Nature of science in Science Education*, 163-176. Dordrecht: Kluwer Academic Publishers. Dordrecht:
- Driver, R.; Sauires, A., Rushworth, P., Wood-Robinson, V. (1994) *Making sense of secondary science: Research into children's ideas*. London & New York: Routledge
- Duit, R.; Niedderer, H.; Schecker, H. (2007) *Teaching Physics*. In: Abell, S. K. & Ledermann, N. G. Handbook of Research on Science Education, N.Y: Routledge, Chapter 21 (pp: 599-627)
- Duit, R. (2009) *Bibliography – STCSE, Students' and Teachers' Conceptions and Science Education*. Kiel: IPN. Update up09.rtf / March 23, 2009
- Duschl, R. (1990) *Restructuring Science Education*, New York: Teachers College Press
- Faraday, M., (1839-1855) Identity of Electricities Derived from Different Sources. In: *Experimental researches in Electricity*. vol.,1 (1965) Taylor and Francis, London
- Furió C.; Guisasola, J.; Almudí, J. M. (2004) Elementary electrostatic phenomena: Historical hindrances and students' difficulties, *Canadian Journal of Science, Mathematics and Technology Education*, 4:3, 291-313
- Giere, R. (1992) *Cognitive Models of Science*, Minneapolis: University of Minnesota Press
- Gilbert, J.K.; Bulte, A. M.; Pilot, A. (2010) Concept Development and Transfer in Context-Based Science Education. *International Journal of Science Education*, Vol. 33, N° 6, pp: 817-837
- Gross, A. (1990) *The Rethoric of Science*. USA: Harvard University Pres
- Guidoni, P. (1985) On Natural Thinking. A: *European Journal of Science Education*, 7, 133-140
- Harrington, R. (1999) Discovering the reasoning behind the words: An example from electrostatics. In: *American Journal of Physics* 67, pp: 58-59
- Heering, P. (2000) Getting shocks: Teaching secondary schools physics through history. *Science and Education*, 9, 363-373
- Heering, P.; Klassen, S.; Metz, D. (eds) (2013) *Enabling Scientific Understanding Trough Historical Instruments and Experiments in Formal and Non-formal Learning Environments*. Flensburg Studies in the History and Philosophy of Science in Science Education (Vol. 2) Flensburg: University Press
- Heilbron, J. (1979) *Electricity in the 17th and 18th Centuries: A study in Early Modern Physics*, University of California Press, Berkeley
- Heilbron, J. (2002) History in science Education, with Cautionary Tales about the Agreement of Measurement and Theory! *Science & Education* 11 (321-331)
- Holton, G. (1978) *The Scientific Imagination: Case Studies*. London: Cambridge University Press
- Holton, G. (1979) *Introducción a los Conceptos y a las ideas de las Ciencias físicas*, Barcelona: Reverté
- Iglésies, J. (1965) *La Contribució Catalana al Telègraf Elèctric (Francesc Salvà i Campillo 1751 – 1718)* Barcelona: Rafael Dalmau Eds
- Iglésies, J. (1964) La Real Academia de Ciencias Naturales y Artes en el siglo XVIII, *Memorias de la Real Academia de Ciencias y Artes de Barcelona*, 3ra época, núm. 707, vol 36, núm. 1
- Izquierdo, M. (1996) Relación entre la historia y la filosofía de la ciencia y la enseñanza de las ciencias. *Alambique*, 8, 1-21
- Izquierdo, M.; Arduiz, A. (2003) Epistemological fundamentation of School Sciene. In: *Science and Education*, 12, pp27-43
- Khun, D. (1993) Science as Argument: Implications for Teaching and Learning Science Teaching, *Science Education* 77 (3), 319-337
- Knight, R. D. (2004) *Five Easy Lessons. Strategies for Successful Physics Teaching*. San Franciso: Adisson and Wesley
- Laudan, L. (1978) *The Progress and its Problems*, Berkeley: The University of California Press
- Leach, J.; & Scott, P. (2002) Designing and evaluating science teaching sequences: An approach drawing upon the concept of learning demand and a social constructivist perspective on learning. *Studies in Science Education*, 38, 115-142
- Lochhead, J., Dufresne, R. (1989) Helping Students Understand Difficult Science Concepts Through the Use of Dialogues with History: In: Herget, D. (ed) *History and Philosophy of Science in Science Education*

- (Proceedings of the First International Conference), Science Education and Department of Philosophy. Florida State University, Tallahassee, Florida, pp. 221-229
- Mattews, M. (1994a) History and Philosophy in the Classroom: The Case of Pendulum Motion, in M. Mattews (ed), *Science Teaching, The Role of History and Philosophy of Science*, N.Y.: Routledge
- Mattews, M. (1994b) Historia, filosofía y enseñanza de las ciencias: la aproximación actual. *Enseñanza de las Ciencias*, 12 (2), 511-532
- McCloskey (1983) Intuitive Physics. In *Scientific American*, 4 (248) pp 114-122
- McComas, W. (1998) *The Nature of Science in Science Education. Rationales and Strategies*, Dordrecht: Kluwer
- Millar, R.; Osborne, J. (2000) *Beyond 2000: Science education for the future*. London: School of Education, King's College London
- Níaz, M. & Rodríguez, M. (2002) Improving learning by discussing controversies in 20th century Physics. *Physics Education*, 37 (1) 59-63
- Ogborn, J., Kress, G., Martins, I.; McGillicuddy, K. (1996) *Explaining Science in the Classroom*, Buckingham: Open University Press
- Pera, M.; Shea W.R.(1991) *Persuading Science. The Art of Scientific Rhetoric*. USA: Science History Publications
- Pearce Williams, L. (1965) *Michel Faraday. A Biography*, Chapman and Hall, London/New York
- Pfund, H., & Duit, R. (1998) *Bibliography: Students's alternative framework and science education*. Kiel: IPN (Institute for Science Education)
- Priestley, J. (1775) *The History and Present State of Electricity with original experiments*, Vol 1. Reprinted from the third Edition, London, with appendix containing two original experiments by the author. JOHNSON reprint corporation (1966) New York/London
- Rosmerduc, J. (1987) *Histoire de la physique* Vol. I Paris: Technique et documentation, Lavoisier
- Saltiel, E.; Malgrange, J.L. (1980) Les raisonnements naturels en cinématique élémentaire, *Bulletin de l'Uniu des Physiciens*, 616, 1352-1354
- Seroglou, F.; Koumaras, P.; Tselfes, V. (1998) History of science and instructional design: the case of electromagnetism, *Science & Education* 7, 261-280.
- Taton, R. (1973) *Història General de las Ciencias*, Ediciones Destino, Barcelona, vol. 2 (1972) i vol. 3 (1973)
- Viennot, L. (1996) *Raisonnement in Physics. The part of the sense comun*. Paris : Practiques Pedagogiques. De Boeck and Larcier.
- Viennot, L. (2013) *Thinking in Physics. The Pleasure of Reasoning and Understanding*. Dordrecht: Springer Science+ Media Business
- Vygotsky, L. S. (1978) *Mind in Society: The development of higher psychological processes*. Cambridge, M.A: Harvard University Press
- Whittaker, E. (1951) *A History of the Theories of Aeter and Electricity*, T. Nelson and sons

Affiliation and address information

Marina Castells Llavanera
 GRIEC-UB (Universitat de Barcelona, Group Research and Innovation on Science Education)
 Campus Mundet
 Passeig de la Vall d'Hebron, 171
 (08035) Barcelona, Catalonia, Spain
 LICEC – UAB (Universitat Autònoma de Barcelona, Language and Context in Science Education)
 E-mail: marina.castells@ub.edu

Nature of Science in Science Education: a Proposal Based on ‘Themes’

André Ferrer Pinto Martins; Jim Ryder

Universidade Federal do Rio Grande do Norte, Brazil; University of Leeds, UK

Abstract

This theoretical analysis addresses some issues related to *knowledge about science* in science education, in general, and in physics education, in particular. We point out the existence of a “consensus view” about Nature of Science (NOS) in science education research literature. Then we argue that: 1) despite its relevance to science teaching, the “consensus view” hides some important divergences that should not be overlooked. In particular, we challenge the idea of the existence of a consensus, showing that there are different routes, terminologies, starting points and conclusions when we analyse literature elaborating this “consensus”; 2) there are some problematic statements in the “consensus view”; and 3) taken (1) and (2) into account, we suggest a more open, pluralistic and heterogeneous approach to deal with the *knowledge about science* in school science curriculum.

Keywords

Knowledge about science; nature of science; epistemology; science curriculum

1. Introduction

It is not new that the community of science educators acknowledges the importance of learning *about science* within science education. This theme has a long history in the area and remains a challenge to be faced. In addition to the contents present at various teaching levels, a deeper understanding of how science works, how scientific knowledge is produced, validated and communicated, as well as the very nature of this knowledge, in regard to its epistemological particularities, has been seen as something to be sought and of value for science education.

But... *what to teach?* One way to tackle this question is in a negative manner, identifying “what should not be taught”. Over the past decades, many works in the area revealed the existence of a large number of misguided and naïve conceptions about science, held both by students and teachers, such as: the empirical-inductive view of science; a rigid (algorithmic, exact, infallible) view of scientific methodology; cumulative and linear views of the History of Science; decontextualized and socially neutral views of the activities of scientists; individualistic and elitist views of science, among others (see, e.g. Driver et al. 1996; Fernandez et al. 2002; Lederman 1992, 2007).

Identifying mistaken and naïve conceptions of scientific work represented significant progress in science education research, and an understanding of what “should not be taught”. But one can tackle the issue of “what to teach?” in a positive manner, i.e., seeking to build an understanding of what would be a set of themes, aspects, issues, suitable with the prospect of a teaching about sciences. This path is potentially more complex and it has a long history. Particularly over the past few years it has led to the establishment of what is conventionally called the “consensus view” of the Nature of Science (NOS) – this terminology, incidentally, came to prevail in the specialized literature on this. The so-called “consensus view” (CV) has received diverse types of criticism (e.g. Alters 1997; Rudolph 2000; Clough 2007; Allchin 2011; Irzik and Nola 2011; Van Dijk 2011; Matthews 2012; Dushl and Grandy 2013) while, on the other hand, has been developed and gaining support (e.g. Lederman 1992, 2007; McComas et al. 1998; Osborne et al. 2003; McComas 2008; Abd-El-Khalick 2012a, 2012b). Given this debate it is important to ask: is this the best way to build curricula and think about what to teach?

Following from the above, this article aims to defend three central ideas: (1) Despite its relevance to science teaching, the “consensus view” hides some important divergences that should not be overlooked; (2) There are some problematic statements in the “consensus view”; (3) Taken (1) and (2) into account, we suggest a more open, pluralistic and heterogeneous approach to deal with the *knowledge about science* in school science curriculum.

2. The “consensus view”: an approach and some criticisms

We begin with point (1). Firstly, it is important to state that, for us, it is clear that a consensus on a philosophical level is unattainable. Science is a much too complex social venture to enable a single characterization. Aware of the lack of consensus on a philosophical level, the consensus view (CV) seeks to present a set of factors about which there would be a broad consensus regarding what is expected to be present in school science curriculum. A pragmatic consensus on certain aspects would be valid for the inclusion of NOS contents in schools. In this sense, the criticism addressed to the CV regarding a lack of consensus among philosophers with respect to a characterization of science (e.g. in Alters 1997) loses some of its strength.

But it is precisely this second level of consensus, valid for school science education, which we will address here. When we look at the specialized literature in this respect we find studies that show the existence of multiple *paths/routes* to build an understanding related to the question “what to teach?” about NOS and also the existence of different *terminologies, starting points* and *conclusions*.

Principal texts supporting the establishment of the CV, such as McComas and Olson (1998), McComas et al. (1998) and McComas (2008), e.g., are based on official science education standards documents, whose analysis leads to the creation of NOS tenets. This path may be considered more normative (or nomothetic) and scholarly, and can be illustrated by the very categories used in the classification of the ideas presented in these documents (Philosophy of science, History of science, Psychology of science and Sociology of science), which represent areas of academic knowledge somehow related to the NOS theme.

Others, Driver et al. (1996) and Ryder (2001, 2002) for example, take a different path. In the first case, a description of “what to teach?” is reached starting from an empirical study with students between nine and sixteen years old. The last two works start from an analysis of thirty one case studies related to situations involving the interaction of people with science outside the context of formal education. This results in some suggestions for specific areas of NOS that are needed within school curricula aiming to promote the goals of scientific literacy. This latter path may be considered more empirical and, in a sense, more ideographic (to use the very distinction made by Driver et al. 1996, p. 58).

As a result, there are differences in the conclusions. Although there is significant similarity between aspects of NOS identified in these studies, there are also significant differences. The list of NOS tenets contains short, direct and domain-general statements about science, balancing, in a sense, contents of the four areas (Philosophy of science, History of science, Psychology of science and Sociology of science). In Driver et al. (1996, p. 144-147) we find another classification (“epistemological basis for scientific knowledge claims” and “science as a social enterprise”), whose subcategories are described in more lengthy and exhaustive way. In Ryder (2001, p. 8), the categories with the closest connection to the NOS thematic are: collecting and evaluating data; interpreting data; modelling in science; uncertainty in science, and science communication in the public domain. While issues related to sociology of science appear less represented in the studies of Ryder (2001, 2002), it seems evident that the CV does not consider more deeply the *processes of science*, which arise in such analyses of these latter works cited.

This is an important point. Thus, although McComas et al. (1998, p. 6) state: “There is no one way to do science (therefore, there is no universal step-by-step scientific method)”, information on methods does not go beyond this point. Similarly, although we can read in McComas (2008, p. 251) that: “(A) Science produces, demands and relies on empirical evidence” and “(B) Knowledge production in science shares many common factors and shared habits of mind, norms, logical thinking and methods such as careful observation and data recording, truthfulness in reporting, etc.”, a more detailed description of what such methods would be, or what is involved in collection and interpretation of data, is missing. Driver et al. (1996, p. 144) suggest the category “evaluation of evidence” that, among other aspects, emphasizes the importance of: “(...) understanding concepts of accuracy, reliability, validity and replicability (...); ways of organizing the collection of data so that logical inferences can be made about the influence of specific variables or features of a system (...)”. In Ryder (2001, p. 8) consideration of the processes of science is far more explicit in some of the study synthesis categories: Collecting and evaluating data (Assessing the quality of data and Study design); Interpreting data (Assessing the validity of interpretations in science; correlation and causation; considering alternative explanations; time horizons; Interpretation involves knowledge sources in addition to data; Multiple interpretations in science).

It does not seem appropriate to minimize such differences in routes, points of departure and conclusions, stating for example that the discussion of the processes of science¹ is present implicitly in the CV. The differences are deeper than that and related directly to a consideration of what should be the object of teaching in classrooms and should, in one way or another, be present in curricula. At this point it is worth referring to the work of Osborne et al. (2003), which attempts to reconcile the CV with the results of an empirical study with experts from different fields (science educators, scientists, historians, philosophers and sociologists of science; experts engaged in work to improve the public understanding of science, and science expert teachers). Although there is some correlation between certain NOS *tenets* and *themes* emerging from the study with the Delphi methodology (Osborne et al. 2003, p. 713), it is precisely with reference to the processes and methods of science that correspondence seems unsupported: the ideas of “analysis and interpretation of data” (and the description of what this means) are broader than the CV claim that “science relies on empirical evidence”. The same goes for the theme “scientific method and critical testing”.

Another aspect of this discussion refers to the terminology present within many works. While the phrase “nature of science” has become commonplace in the specialized literature of science education and can be considered a “catch phrase” (Hipkins et al. 2005), other related studies prefer the term “knowledge about science”, “how science works”, “epistemology of science” or even “ideas-about-science”. This can even be seen in the choice made by the authors in relation to the keywords in each work (recently, an Editorial in *Science & Education* (Krogh and Nielsen 2013) revealed the existence of a debate about this question of terminology).

The differences pointed out above (in routes, starting points, terminologies and conclusions) suggest some limitation to a consensual perspective, even if restricted to the curricular inclusion of NOS contents. This limitation becomes more evident when we turn to some criticisms of the CV. Clough (2006, 2007), for example, points to the fact that the NOS tenets can be easily distorted by researchers, teachers and students, becoming something to be transmitted – more than investigated – in science classrooms. Thus, he proposes that nature of science aspects should be addressed as *questions* rather than tenets (e.g. “In what sense is scientific knowledge tentative? In what sense is it durable?” instead of the tenet “Scientific knowledge while durable, has a tentative character”). Allchin (2011, 2012) also criticizes the type of declarative knowledge presented in the lists of NOS tenets. For this author, these lists are “inherently incomplete and insufficient for functional scientific literacy” (Allchin 2011, p. 524). They omit many relevant items, for example the significant role of credibility, the social interaction of scientists, the peer review process, cognitive biases, fraud, among others (Allchin 2004, 2011). Irzik and Nola (2011) state that the CV has a number of shortcomings and weaknesses, the main one being to disregard the variations in the detail of nature of sciences across different areas of science. A similar issue had been raised by Rudolph (2000), for whom the particular practices of the various sciences should guide an understanding of the nature of science, rather than a universal conception of what science is. Similarly Matthews (2012) criticizes what he calls the “Lederman Programme”, arguing that NOS elements have to be more historically and philosophically refined. He proposes a change in terminology and in research focus: from Nature of Science (NOS) to Features of Science (FOS). Matthews claims that this shift to a more contextual and heterogeneous perspective would avoid some educational and philosophical pitfalls associated with the research in NOS.

3. Some problematic statements

Even accepting the limitations and simplifications inherent to the CV as well as the idea that the NOS tenets are general statements that require further detail, we consider that some aspects of the CV are unclear and/or problematic. Take, for example, the idea that “science has developed through ‘normal science’ and ‘revolution’ as described by Kuhn (1962)”, as appears in McComas (2008, p. 251). The particular view of science provided by Thomas Kuhn, notwithstanding it may have a large number of supporters in the area of science education, is far from unanimous, and this particular epistemology brings together several other controversial notions (e.g.: incommensurability, paradigm). It is entirely legitimate that someone has another view of the historical development of science and does not support to the conception of “revolution”. Thus, a commitment to a particular epistemology may be problematic².

¹ It is important to clarify that when we talk about “processes of science” we are not dealing with didactic strategies or conflating NOS issues and scientific inquiry, as Abd-El-Khalick (2012a) warns. We are referring to an *explicit reflection* on the methods and processes of science.

² Although the reference to Kuhn does not appear in all versions and there are certainly other philosophical perspectives underlying the CV, this criticism is addressed to works where that particular ‘tenet’ is present.

Another important statement says: “Scientific knowledge is tentative, durable and self-correcting (This means that science cannot *prove* anything but scientific conclusions are still valuable and long lasting because of the way in which they are developed but *mistakes will be discovered and corrected as part of the process*)” (McComas 2008, p. 251, second stress added). On the one hand, it is fragile to state that “mistakes” will be discovered and corrected. On the other hand, it is quite plausible that the statement leads to think that a scientist is usually able to discover and correct their mistakes. Here again, a problem arises if we use Kuhn’s epistemology. After all, the practice of normal science shows that “errors” are often not fixed (or even perceived) by practitioners. The famous phrase of Max Planck, that a new scientific truth does not thrive because opponents see the reason, but because they eventually die and a new generation grows familiar with the new ideas³, is emblematic here. It can be said that the statement made by the CV requires a long period of time. Still, the very idea of “errors” seem to be at odds with Kuhn’s notion of incommensurability and the idea that scientists who choose different paradigms live in “different worlds”, and suggest – implicitly – some linear and cumulative view of the construction of scientific knowledge.

Somewhat more problematic is the statement: “Science has a subjective element. In other words, ideas and observations in science are ‘theory-laden’”. We agree with the idea that science is “theory-laden”. However, it seems to us very different to say that science has a subjective element. These two statements do not say the same thing. One aspect much highlighted within the sociology of science and even by discussions on NOS in the science education area is the way in which science constitutes a socially shared knowledge, constructed collectively in a process of dialogue and, therefore, *intersubjective*. Scientific knowledge is endorsed by the scientific community, in a complex process which includes the peer review process. When we equate “theory-laden” with “subjective element”, we get the impression that the *theories* with which we establish our particular look towards the real – shared and socially constructed, *intersubjectively* – are subjective or load of idiosyncratic aspects, and that theories, therefore, are individual, personal.

This view flirts dangerously with a commonsense view that equates “theory” with mere “opinion”, “personal view” (sometimes meaning an “abstract” – but still personal – view). It is not uncommon to hear something like: “I have a *theory* it is going to rain tomorrow”. Or: “advice is just *theory*; living is always very different”. This common usage of the term can have problematic consequences. For example, in the well-known debate between creationism and evolutionary theory, when the latter is seen as a mere “theory” (=opinion). We do not mean here that the CV is not aware of all this or it uses the term “theory” in common sense. The defence of a distinction between laws and theories (one of the NOS tenets) would point in the opposite direction. But the original statement that “science has a subjective element” may give rise to misunderstandings.

Our concern here is of similar nature to that exposed by Clough (2007) in the following passage:

Nature of science tenets may be easily misinterpreted and abused. Students often see things in black or white. For instance, when addressing the historical tentative character of science years ago while teaching high school science, my students would jump from the one extreme of seeing science as absolutely true knowledge to the other extreme as unreliable knowledge. Extensive effort was required to move them to a more middle ground position. Colleagues have told me of students who have asked why they have to learn science content if it’s always changing (Clough 2007).

The conclusion is *not* that the CV should be dismissed or overlooked. What has been said in this section is intended to emphasise that caution should be taken with certain statements (and with the whole set) when we think about curriculum or teacher training programs to deal, in the classroom, with NOS. The deconstruction of misconceptions about science must be accompanied by a careful construction of more current and appropriate views.

Given this complexity of issues and debates, how can the knowledge about NOS derived from research in science education guide the development of curricula? We consider this issue in the following section.

4. NOS in the curriculum: a proposal based on ‘themes’

The issues (1) and (2) treated in the previous sections lead us to conclude that a more adequate consideration of NOS in science curricula should start from a more open, pluralistic and heterogeneous perspective. The

³ “A new scientific truth does not triumph by convincing its opponents and making them see the light, but rather because its opponents eventually die, and a new generation grows up that is familiar with it”. (Planck 1950, p. 33-34).

idea of family resemblance (Irzik and Nola 2011) may be an interesting starting point for thinking about NOS contents. In any case, no list will be exhaustive and it will always have problems. Even if there was a consensus around such a list, enormous difficulties related to assessment and teacher training would remain.

It seems clear to us, at this point, that lists as presented by the CV are useful to have as a reference to consult. An important next step is to construct proposals specially designed to address all levels of education and the various scientific disciplines (here the idea of family resemblance gains strength, since the characteristics of the various sciences, in relation to NOS, are different). As stated by Taber (2008), one should seek an “intellectually honest simplification” when thinking about contents to be taught.

There are several valid approaches. For us, before we get to something like “NOS tenets”, it seems reasonable to think of something like “NOS themes”. Studies in the literature suggest possible paths. Following closely the book of Driver et al. (1996), we identify two main axes: the *sociological and historical axis* and the *epistemological axis*. The first axis would group themes relating to the role of the individual and the scientific community; intersubjectivity; moral, ethical and political issues; historical and social influences; science as part of culture; communication of knowledge. The second axis, a broader one, would group together themes relating to the origin of knowledge (experience vs. reason; role of observation, experience, logic and theoretical thinking; influence of the theory on experiment), methods, practices, procedures and processes of science (collection, analysis and evaluation of data; inference, correlation and causality; modelling in science; role of imagination and creativity; nature of explanation), and nature/content of the knowledge produced (role of laws and theories; notion of model; similarities and differences between science and other forms of knowledge).

Without intending to create lists or represent that idea exhaustively, we indicate in Table 1 the two axes, with examples of themes that could be explored.

Table 1 Axes for discussion about NOS content and examples of NOS themes

<i>Sociological and historical route/axis</i>	<i>Epistemological route/axis</i>		
	Problem of the origin of (scientific) knowledge	Methods, procedures and processes of science	Content / nature of knowledge produced
<ul style="list-style-type: none"> • Role of the individuals/subjects and the scientific community • Intersubjectivity • Historical and social influences • Moral, ethical and political issues • Science as part of a major culture • Aims of science / aims of scientists • Communication of scientific knowledge within scientific community and in a public domain • Historical and contemporary controversies in science • Science and other types of knowledge • Science and technology 	<ul style="list-style-type: none"> • Subject(s) and object(s) of scientific knowledge • Empirical vs. theoretical • Role of observation, experiments, logic, rational arguments and theoretical thinking • Theoretical influences on observations and experiments • {Differences between scientific areas/disciplines} 	<ul style="list-style-type: none"> • Collection, interpretation, analysis and evaluation of data • Modelling • Observation and inference • Hypothesis, predictions and tests • Correlation and causality • Nature of explanation in science • Evaluation of theories • Role of analogies, imagination and creativity • Common sense view about scientific method (step-by-step sequence) • Science and other 	<ul style="list-style-type: none"> • Laws and theories • Postulates • Notion of scientific model • Role of Mathematics • Power and limitations of scientific knowledge • Science and other types of knowledge • Science and technology • {Differences between scientific areas/disciplines}

<ul style="list-style-type: none"> • {Differences between scientific areas/disciplines} 		types of knowledge	<ul style="list-style-type: none"> • {Differences between scientific areas/disciplines}
--	--	--------------------	--

These two major axes are obviously interrelated. The division is to some extent artificial because the aspects properly *epistemic* and distinctive of the “nature” of knowledge produced come from a construction that is collective (intersubjective), *historical* and *social*. The theme of the origin of knowledge (2nd axis), for example, can be put in terms of how it has been seen along the historical and social evolution of science (1st axis). Likewise, a theme like “aims of science” involves both the relationship science ↔ society (1st axis), which historically shaped the goals associated with the construction of this knowledge, as well as the type of relationship subject(s) ↔ object(s) (2nd axis), the basis of this construction. This theme can also relate to the idea of “nature of explanation in science” (2nd axis), since the way explanations and justifications of scientific knowledge are given relates to the goals and objectives associated with this knowledge.

A theme that can be approached from different perspectives is “science and other types of knowledge”. Considered from a historical and sociological (1st axis) point of view, we might explore historical and social differences between distinct cultures, as well as the gradual consolidation of science as a body of systematized knowledge, differing over the centuries from other forms of knowledge. From an epistemological point of view (2nd axis), the proper *methods and processes of science* are crucial to understand the differences between scientific and other types of knowledge. Moreover, it is precisely with regard to the *nature/content of knowledge produced* that distinctive features of science might be explored, such as its conjectural character, the notion of truth (not absolute), the idea of ruptures and continuities, the nature of change in science, the ideas of prediction, internal consistency and simplicity as well as characteristics of scientific language.

We conclude these brief comments about the Table 1 by pointing out that the *differences between scientific areas/disciplines* is something to be addressed under the different axes and themes. Historical (1st axis) differences, as well as epistemological (2nd axis) differences, such as the various methodologies used in different areas (in vitro, in vivo, double blind tests etc.), would be the object of attention. In this aspect, contextual and specific aspects of the various areas could be better explored.

A further analysis might involve taking these axes and themes and describing in more detail what should be taught. This would lead us to something similar to the NOS tenets proposed by CV (although works of this kind do not address exactly these same axes and themes). In a sense, the work of Abd-El-Khalic (2012a, 2012b) follows this direction by suggesting a spiral curricular structure in which a certain aspect of NOS would be addressed at different levels of depth along the formal education at many school levels. This path is valid and may undoubtedly be a guide for curriculum development.

We believe, however, that the very arguments exposed in this work justify another approach. It is important to remember that structuring and *designing* curricula is a broader and more complex process that involves – or should involve – a range of social actors (educators, scientists, politicians, members of the school community, teachers, parents and communities in general, students) and not just science educators. Thus, these axes and themes themselves could be guides for curricular choices (with subsequent definition about NOS contents) which would be built from more particular/specific contexts provided, e.g.: by specific scientific areas and subject matter contents; by school level; by local, regional and national issues of interest, among others. In short: working from major axes and themes, the details would come up in a more contextualized manner. This contemplates, to some extent, the flexibility necessary to incorporate the plurality of views on aspects of NOS, especially with respect to the various scientific disciplines. Additionally, it prevents premature formulation of “general principles” on NOS that does not need to be present at that time. Thus, the use of themes would avoid many problems associated with the CV and the NOS tenets, providing a more open and plural approach in the treatment of NOS issues in school science curriculum⁴.

Certainly this detailing process will be informed by the knowledge built in science education area about these axes and general themes. We see here the fields of History, Philosophy and Sociology of Science

⁴ Certainly other perspectives are possible, such as, e.g., the notion of ‘structuring theoretical fields of the philosophy of science’ (Adúriz-Bravo 2004; Adúriz-Bravo and Izquierdo-Aymerich 2009; Adúriz-Bravo et al. 2002) which, although it has been developed in the context of pre- and in-service science teachers, could be another starting point for thinking about curricula designs. In a similar context (trainee teachers), Taber (2008, see Appendix) presents a document used in Cambridge that provides a basis for thinking about planning curriculum models to teach aspects of NOS.

feeding the discussion around these axes and themes. Without a reasonable minimum knowledge of these fields, the detailing of these themes would mean very little. Worse than that, it may result in a list of dogmatic assertions that mixes diverse views and does not become operational, being rejected in the future – and in practice – by science teachers in schools.

5. Conclusion

Notwithstanding its diverse meanings, the scientific literacy of the general population continues to be a goal of many those concerned with science education. Science should not be presented to students at schools in a dogmatic way and/or limited to the knowledge of science *content* – seen, wrongly, as a set of facts and claims about phenomena. In this sense, a scientific literacy should also embrace *knowledge about science*. Research in science education has advanced significantly in this direction, and we are today in a better position to inform educators in general, and curricula developers in particular, in relation to such *metascientific* content. As is characteristic of the humanities, the complexity and richness of ideas remains a virtue to be considered. In this sense, the search for a consensus view may be an arduous task.

Our attempt in this work was to signal the difficulty of this consensus and some other issues that emerge from the so-called consensus view and deserve attention. We consider appropriate that the perspective of inclusion of NOS themes in science curricula has a wider and pluralistic starting point that, to some extent, incorporates what has been discussed in the literature. The approach of many groups, such as science educators, historians, philosophers, sociologists, scientists, educators in general, teachers and other members of school community, tends to be fundamental to the development of curricula that make sense of, and respond to, social demands.

Acknowledgements

The main author wish to thank Coordenação de Aperfeiçoamento de Pessoal de Nível Superior (CAPES/Brazil) for financial support of the research project related to this publication (process number 4044-13-4).

References

- Abd-El-Khalick, F. (2012a). Examining the sources for our understandings about science: enduring confluences and critical issues in research on nature of science in science education, *International Journal of Science Education* **34**, 353–374.
- Abd-El-Khalick, F. (2012b). Nature of science in science education: Toward a coherent framework for synergistic research and development. In Fraser B.J., Tobin K. and McRobbie C. (Eds.), *Second international handbook of science education* (pp. 1041-1060). The Netherlands: Springer.
- Adúriz-Bravo, A. (2004). Methodology and politics: a proposal to teach the structuring ideas of the philosophy of science through the pendulum, *Science & Education* **13**, 717–731.
- Adúriz-Bravo, A. and Izquierdo-Aymerich, M. (2009). A research-informed instructional unit to teach the Nature of Science to pre-service science teachers, *Science & Education* **18**, 1177–1192.
- Adúriz-Bravo, A., Izquierdo-Aymerich, M. and Estany, A. (2002). Una propuesta para estructurar la enseñanza de la filosofía de la ciencia para el profesorado de ciencias en formación, *Enseñanza de las Ciencias* **20**, 465–476.
- Alters, B. J. (1997). Whose nature of science? *Journal of Research in Science Teaching* **34**, 39-55.
- Clough, M. P. (2007). Teaching the nature of science to secondary and post-secondary students: questions rather than tenets, *The Pantaneto Forum* **25**.
<http://www.pantaneto.co.uk/issue25/front25.htm>. Accessed 25 May 2014.
- Driver, R. H., Leach, J., Millar, R. and Scott, P. (1996). *Young people's images of science*, Open University Press, Buckingham, UK.
- Dushl, R. A. and Grandy, R. (2013). Two views about explicitly teaching Nature of Science, *Science & Education* **22**, 2109-2139.
- Fernández, I., Gil, D., Carrascosa, J., Cachapuz, A. and Praia, J. (2002). Visiones deformadas de la ciencia transmitidas por la enseñanza, *Enseñanza de las Ciencias* **20**, 477-488.

- Hipkins, R., Barker, M. and Bolstad, R. (2005). Teaching the 'nature of science': modest adaptations or radical reconceptions? *International Journal of Science Education* **27**, 243–254.
- Irzik, G. and Nola, R. (2011) A Family Resemblance Approach to the Nature of Science for Science Education, *Science & Education* **20**, 591-607.
- Izquierdo, M. and Adúriz-Bravo, A. (2003). Epistemological foundations of school science. *Science & Education* **12**, 27-43.
- Khishfe, R. (2013). Transfer of Nature of Science understandings into similar contexts: promises and possibilities of an explicit reflective approach, *International Journal of Science Education* **35**, 2928-2953.
- Krogh, L. B. and Nielsen, K. (2013). Introduction: How Science Works - and How to Teach It, *Science & Education* **22**, 2055–2065.
- Lederman, N. G. (1992). Student's and teacher's conceptions of the nature of science: a review of the research, *Journal of Research in Science Teaching* **29**, 331-359.
- Lederman, N. G. (2007). Nature of science: past, present and future. In Abell, S.K. and Lederman N.G. (Eds.), *Handbook of research on science education* (pp. 831-879). Mahwah, NJ: Lawrence Erlbaum Associates.
- Matthews, M. R. (2012). Changing the focus: from nature of science to features of science. In Khine M. S. (Ed.), *Advances in nature of science research* (pp. 3-26). Dordrecht: Springer.
- McComas, W. F. (2008). Seeking historical examples to illustrate key aspects of the nature of science, *Science & Education* **17**, 249-263.
- McComas, W. F. and Olson, J. K. (1998). The Nature of Science in international science educational standards documents. In McComas W. F. (Ed.), *The Nature of Science in Science Education: rationales and strategies* (pp. 41-52). The Netherlands: Kluwer.
- McComas, W. F., Almazroa, H. and Clough, M. (1998). The Nature of Science in Science Education: an introduction, *Science & Education* **7**, 511-532.
- McComas, W. F., Clough, M. and Almazroa, H. (1998). The role and character of the Nature of Science in Science Education. In McComas W. F. (Ed.), *The Nature of Science in Science Education: rationales and strategies* (pp. 3-39). The Netherlands: Kluwer.
- Osborne, J., Collins, S., Ratcliffe, M., Millar, R. and Duschl, R. (2003). What "Ideas-about-Science" should be taught in school science? A Delphi study of the expert community, *Journal of Research in Science Teaching* **40**, 692-720.
- Planck, M. K. E. L. (1950). *Scientific autobiography and other papers*, Williams & Norgate, London, UK.
- Rudolph, J. L. (2000). Reconsidering the 'nature of science' as a curriculum component, *Journal of Curriculum Studies* **32**, 403-419.
- Ryder, J. (2001). Identifying science understanding for functional scientific literacy, *Studies in Science Education* **36**, 1-44.
- Ryder, J. (2002). School science education for citizenship: strategies for teaching about the epistemology of science, *Journal of Curriculum Studies* **34**, 637-658.
- Taber, K. S. (2008). Towards a curricular model of the Nature of Science, *Science & Education* **17**, 179-218.
- Van Dijk, E. M. (2011). Portraying real science in science communication, *Science Education* **95**, 1086-1100.

Affiliation and address information

André Ferrer Pinto Martins
CE - Centro de Educação, Universidade Federal do Rio Grande do Norte
Campus Universitário, BR 101, Lagoa Nova
59072-970 Natal, RN, Brazil
email: andre.ferrer@pq.cnpq.br ; aferrer34@yahoo.com.br

Jim Ryder
CSSME - Centre for Studies in Science and Mathematics Education University of Leeds

School of Education
LS2 9JT Leeds, United Kingdom
email: J.Ryder@education.leeds.ac.uk

Chapter 9
Pedagogical Methods and Strategies

The Role of Teaching Scaffolding in Inquiry-based Learning of Black-Boxed Electric Circuits

Wheijen Chang

National Changhua University of Education, Taiwan

Abstract

The purpose of this study is to design, implement, and modify an inquiry-based project based on student responses and performance demonstrated in four phases. Each phase consists of different groups of students. Contrary to the didactic instruction of manipulating conventional problems, the inquiry-based learning contains three black-boxed circuit units, in which the students are required to “reversely” reason the possible circuits by observing the brightness distribution. The research data include students’ performance and a questionnaire survey. Both types of data were analyzed and compared. The early phase implementation encountered several challenges, such as insufficient clues to reason a specific circuit, and feeling unacquainted with the “reverse” reasoning. Accordingly, additional teaching scaffoldings were gradually supplemented, including disconnecting one light bulb to specify the possible circuit, as well as spiral teaching and learning sequences. The results show that providing intensive scaffoldings was crucial for facilitating effective reasoning, and enhancing learning commitments and conceptual comprehension. However, although this study highlights the demand for and benefits of providing comprehensive scaffoldings, a repeated teaching sequence may be redundant to facilitate the students’ performance. In order to optimize the extent of teaching scaffolding, multiple phases of implementation, reflection, and modification are pivotal.

Keywords

Inquiry-learning, scaffolding, electric circuits, curriculum development

1. Introduction

In recent decades, there has been a gradual consensus that treating students as passive receivers of knowledge is ineffective for learning physics (McDermott, 1993). Students need to engage cognitively, and participate in scientific practice in order to achieve conceptual comprehension and grasp the scientific way of reasoning (Duit & Treagust, 1995; Roth, McRobbie, Lucas, & Boutonne, 1997). Accordingly, *inquiry-based learning* has recently drawn the interest of science educators and instructors. Anderson (2002) defined “inquiry” as an *active mental* process that demands the active participation of learners. The purposes of inquiry-based learning are to improve students’ understanding of both science content and scientific practices (Edelson, Gordin, & Pea, 1999). However, while designing and implementing inquiry-based learning, the expected learning outcomes may not be easily fulfilled. The literature provides a warning that conducting open-form inquiry-based learning is very challenging, such as grasping the appropriate extent of teaching guidance or facilitating learning motivation, etc. (Kock, Taconis, Bolhuis, & Gravemeijer, 2013; Roth, 1996).

Most students regard physics as a difficult subject to learn. However, compared with the topics of mechanics and electrostatics, electric circuits is seen as a relative easy topic as the formulas involved have simpler mathematical forms. In Taiwan, students begin to learn the concept of electric circuits in grade 9. Therefore, when they are required to learn the topic in their college years, the majority consider it as repetitive and redundant. Nevertheless, when teaching the topic, many university instructors argue that the students may be able to discretely recall some formulas, but are often unable to actively invoke the required principles and further integrate them as a whole (Chang & Bell, 2002).

Similar to many textbooks published in the US, in Taiwan, the chapters of electric circuits normally contain calculations of the equivalent resistance, currents, voltages, and electric power, etc., based on a given circuit diagram. However, few (if any) questions and exercises provide practice of “reverse” reasoning, e.g., imaging possible circuits from observing the phenomena of how each item works.

The purposes of this research are to examine 1) the types and extent of scaffolding that Taiwanese students require to participate in inquiry-based learning, 2) the demand of different levels of scaffolding corresponding to different types of learning tasks, and 3) the progression of instructional design throughout the several phases of modifications based on the participants' responses.

2. Literature

With respect to their difficulty in reasoning electric circuits, students may inappropriately use the *sequential* and *superposition* models in their reasoning (Sebastia, 1993). Sequential reasoning believes that the current travels around the circuit and is influenced *only* by those elements it encounters (Shipstone, 1984), which approach can be a useful strategy for many topics, such as waves, but may not be adequate for electric circuits. Similarly, the superposition model is powerful for analyzing electric fields, but is not effective for circuit analysis (Ding, *et al.*, 2006). Besides, students show reluctance to reason qualitatively, and prefer quantitative manipulation (Millar & Beh, 1993). In addition, many students have been found to make *topological errors*, e.g., when resistors are in line they are in series, and students are able to easily convert from a realistic connection of a circuit to the corresponding schematic diagram, but have difficulty making the reverse translation (Engelhardt & Beichner, 2004).

The rationale of inquiry-based learning can be discussed from both the constructivist and sociocultural views of learning. Constructivist views of learning highlight the crucial role of learners cognitively engaging in the learning process, in order to trigger conceptual change from intuitive/naïve ideas to scientific conceptions (Duit & Treagust, 1995). However, while many science educators agree that learners need to actively think and construct their understanding of science knowledge, the teacher's role is unspecified. For example, what types and extent of guidance are adequate for the instructor to provide to students during inquiry learning? Kirschner *et al.* (2006) contended that minimum guidance of inquiry-based learning is less effective than thorough instruction. Congruently, Barman (2002) emphasized the importance of distinguishing between scientific inquiry and student inquiry, since student inquiry involves explicit instruction of *learning strategies* that help them learn science concepts through investigations. Kock *et al.* (2013) found that inquiry questions are usually so open that they are too difficult for the students to obtain the expected results.

On the other hand, the sociocultural view regards learning as a process of enculturation to grasp the scientific ways of viewing and thinking (O'Loughlin, 1992). Scientific practices and reasoning normally require higher-level mental functions. Vygotsky (1978) asserted that higher mental functioning should be mediated by scientific tools and experts, in order to empower the learners to reach the "*zone of proximal development*" (ZPD). Following the theory of ZPD, Wood *et al.* (1976) initiated the term "scaffolding", denoting that the adult controls the elements of the task that are initially beyond the novice learner's capacity. Similar to the context of building construction, scaffolding is a tool that supports workers to reach some comprehension levels which are otherwise inaccessible (Holton & Clarke, 2006). While learning physics, the essential mediated tools may include words, symbols, diagrams, and physical equipment (Airey & Linder, 2009). However, physics instructors may tend to overlook that the meanings of these tools are not readily understandable by students from their everyday experiences; therefore, repeated instruction and practice are essential to acquire fluency in utilizing the scientific tools (Airey & Linder, 2009; Chang, 2011). Wood *et al.* (1976) suggested key functions of scaffolding, including 1) engaging learners in a meaningful manner, 2) dividing activities into manageable components and accentuating the main parts, 3) demonstrating a model of solution strategy, and 4) reducing the frustration level and ensuring the learners are on-task.

The literature has identified possible challenges of implementing inquiry-based learning (e.g., Kock *et al.*, 2013; Roth *et al.*, 1997; Soloway *et al.*, 1994). Such challenges include 1) students' insufficient learning *motivation* which may result in insufficient engagement to support effective teaching and learning, 2) their lack of background knowledge which may be detrimental to completing meaningful investigations, 3) consequently, it may negatively affect their capability of interpreting the results, and 4) practical constraints of the learning context which may need to be taken into account, such as equipment, technology, or time restrictions. Rooted in the notion of formative assessment (Bell & Cowie, 2000), Beatty *et al.* (2006) and Chang (2011) contended that designing questions to engage thinking is not an easy task, and requires the instructor him/herself to continuously modify the question statements according to the responses of the students.

To implement effective inquiry-based learning, some researchers (e.g., Barron *et al.*, 1998; Blumenfeld *et al.*, 1991; Edelson *et al.*, 1999) have proposed the following teaching strategies, including the need to provide: 1) meaningful problems, which can be used to establish a motivating context for scientific inquiry, 2) staging activities, which are sequences of structured investigations that introduce learners to investigation

techniques and help to develop background knowledge, 3) bridging activities, which utilize familiar practices as a means of introducing unfamiliar scientific practices, and 4) a supportive scaffolding for learners by embedding the tacit knowledge of an expert into the user-interface. To embody these general assertions, this study designed, implemented, and modified specific scaffoldings based on the context of black-boxed circuits to help students achieve the attempted learning outcomes.

3. Methodology

Academic Background of the Students

This study comprised four phases of implementation, evaluation, and modification. Each phase involved a different group of students. The first phase was initiated with 159 Medical students. In order to enter the Medicine department, the students normally possess a very strong background in all subjects including physics. The second and third phases involved two classes of Engineering students, 58 Engineering A and 54 Engineering B students. The inquiry learning was implemented in their introductory physics classes by the first author, after teaching the topic of electric circuits. Phase four involved 85 female high school students, whose background was weakest among the four phases. The duration of implementation of the four phases increased from 60 min, to 80 min, 90 min, and 120 min.

Pedagogical Design and Purposes

Regarding the design of the inquiry-based learning, three units of black-boxed circuits were adopted, where each set of circuits included four identical electric bulbs. To reflect the function of scaffolding suggested by earlier researchers (e.g., Wood *et al.*, 1976; Edelson *et al.*, 1999), the researchers purposefully gradually increased the difficulty of the questions when designing the circuits and inquiry learning questions. In phase 1, only two units (unit 1 and unit 3) were initiated, in which the students were required to solve six learning tasks repeatedly in both units. The demonstrated phenomena, the six tasks units 1 & 3, and the correct answers are listed in Appendix A. The configuration of unit 3 is more complex than that of unit 1. In addition, the difficulties of the six tasks in each unit are gradually increased; the prior tasks serve as reasoning bridges for the latter questions of each unit, as is the scaffolding role of units 1 to 3. Throughout the four-phase implementation, modifications were made based on the students' performance and evaluation. The design of the teaching sequence and the participants of the four phases are listed in Table 1.

The pedagogical purposes of the inquiry learning activity were 1) to increase the cognitive difficulty in order to cultivate the students' thinking ability, 2) to utilize "real-world" questions to facilitate conceptual integration and comprehension, and 3) to engage the students in solving genuine problems to gradually grasp the strategies and perspectives of scientific reasoning.

Table 1: Teaching sequence and participants of the four phases of implementation

Phases	Phase 1	Phase 2	Phase 3	Phase 4
Participants (total #)	Medica 1 (n=159)	Eng. A (n=58)	Eng. B (n=54)	High sch. (n=85)
Teaching sequence				
Organize group discussion*				√
Preview		√	√	√
Denote the brightness/ disconnect bulbs of Unit 1			√	√
Reasoning Unit 1	√	√	√	√
Review Unit 1			√	√
Denote the brightness/ disconnect bulbs of Unit 2		√	√	√
Reasoning Unit 2		√	√	√
Review Unit 2		√	√	√
Denote the brightness/ disconnect bulbs of Unit 3		√	√	√
Reasoning Unit 3	√	√	√	√
Review Unit 3		√	√	√

*Shaded rows are scaffolding provided by the instructor.

Because the medical students possessed a strong background in physics concepts, the only activity was the students' individual reasoning in unit 1 and unit 3. The instructor did not provide any instruction during the inquiry-based learning; the only scaffolding provided was the series of six tasks as shown in Appendix A. However, during the first phase of implementation, they encountered serious difficulties in various forms, including fading memory of their physics knowledge, and being unable to draw circuit diagrams without sufficient clues.

Based on the student responses demonstrated in phase 1, modifications were made accordingly when teaching phase 2. The modifications included: (1) previewing the related knowledge of electric circuits to reawaken the participants' physics background, (2) adding an additional unit (unit 2), the level of difficulty of which is between units 1 and 3, (3) in order to specify the circuits, the instructor explicitly denoted the illumination distribution of the four bulbs and also demonstrated the variation of the four bulbs via disconnecting one bulb in unit 2 and unit 3, and (4) the instructor thoroughly reviewed the problem-solving strategies and solutions for the unit 2 and unit 3 questions. The teaching scaffolding in phase two discloses that all the modifications greatly benefited the students' learning outcomes. Thus, in phases 3 and 4, all of the supplemented scaffoldings were continued, and those made in units 2 and 3 were also extended to unit 1. In addition, considering the weak physics background of the high school students, in phase 4, they were grouped in twos and threes, rather than engaging in individual reasoning.

3. Data Collection and Analysis

Both student performance and a questionnaire survey were collected. The correct percentages of each question were calculated and compared among the different phases. In order to examine the effect of repeated practice and instruction on different types of questions, the students' progression from the former unit to the latter was evaluated using a Chi-square test. Besides, the students were invited to complete an anonymous questionnaire survey, including closed form and open-ended questions. The closed questions included the students' self-evaluation of their learning commitments and achievements, as well as their perceptions of the teaching design and performance. A five point scale, with options ranging from "strongly agree" (5 points) to "strongly disagree" (1 point) was used in the closed questions, and a two-tailed t-test of the average scores was adopted to examine the significant differences between the groups of phase 1 and phase 4. The open-ended questions asked for the students' opinions regarding the strengths, weaknesses, and suggestions of the inquiry-based learning design. Both quantitative and qualitative analysis was adopted.

4. Results

Comparison of the four groups' performance

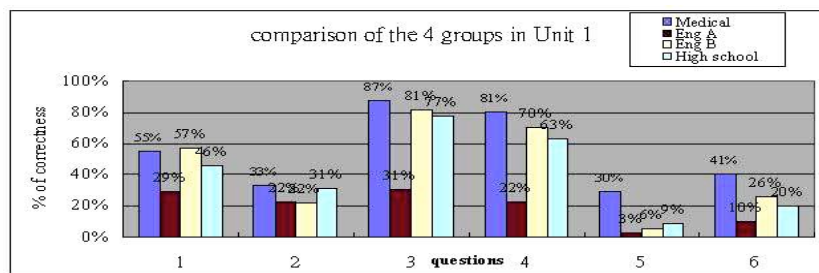

Figure 1. Comparison of the four groups in unit 1

Both the Medical and the Engineering A group students lacked teaching scaffolding denoting the levels of brightness and disconnecting of one bulb. Figure 1 shows that the Medical students performed much better than Eng. A in all questions of unit 1, which is congruent with their background. The results of unit 3 of the four groups are shown in Figure 2.

As Figure 2 indicates, the Medical group appeared to have lost its background advantage in answering questions 1 and 2 when compared with the other three groups which received additional instruction reviewing strategies and the solutions of unit 2. This reveals that the teaching scaffolding may have greatly helped student performance in unit 3. Among the groups, Engineering A improved most significantly in these two questions of unit 1 to unit 3.

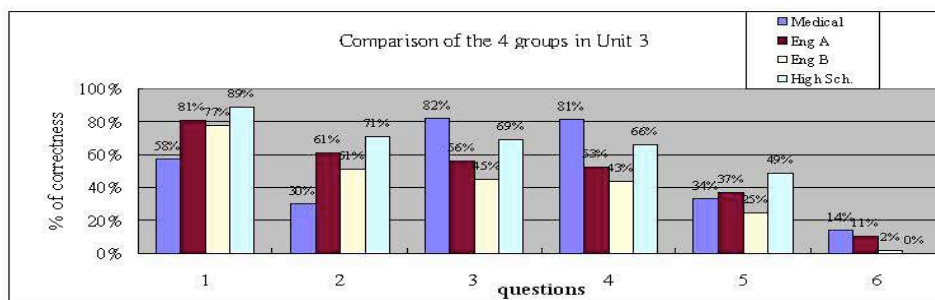

Figure 2. Comparison of the four groups' performances in unit 3

The performance of the latter three groups in unit 2 is displayed in Figure 3. Figure 3 shows that Engineering A performed the worst among the three groups for most questions, which may be attributed to the absence of instructional review of the solutions of unit 1.

In sum, the results of each unit show that teaching scaffolding, such as disconnecting one bulb and instructional review of the prior units, were found to be crucial to the students' performance in the inquiry-based learning for most questions. Even for those who possessed a solid background, such as the Medical group, the teaching scaffolding is still necessary.

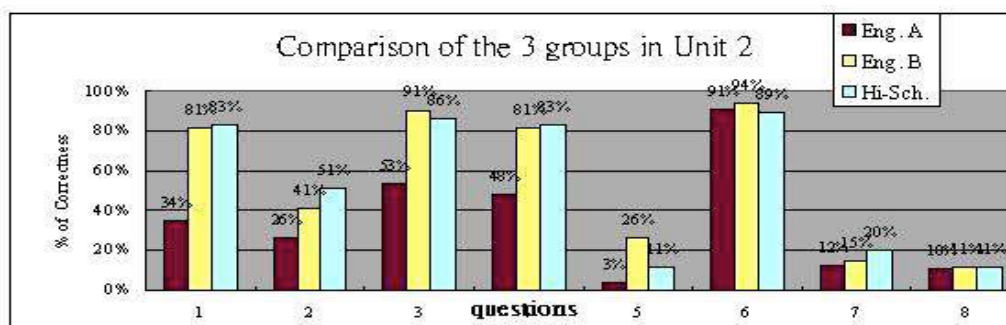

Figure 3. Comparison of the three groups' performances in unit 2

Effects of repeated teaching scaffoldings on different types of questions

Table 2. X² test of the progression among the three units

	Eng B Q1	HS Q1	EngB Q2	HS Q2
unit 1 to 2	21.44*	34.01*	7.67*	5.60*
unit 2 to 3	0.52	1.13	2.25	6.86*

*significant at p<0.05

Since only the Engineering B and High School students were provided with intensive teaching scaffolding of reasoning the circuits, these two groups' performances were examined. Table 2 shows that from unit 1 to unit 2, the improvements were found to be significant for both groups for both Q1 and Q2. However, with repeated teaching scaffolding (from unit 2 to unit 3), only Q2 of the High School group was found to improve significantly. Therefore, repeated teaching scaffolding may be essential for difficult tasks (Q2) but redundant for simple tasks (Q1). Besides, since only the High School group improved significantly with repeated teaching scaffolding in unit 3, group discussion may facilitate the students' persistence in confronting the difficult task.

Students' responses on the survey

As mentioned, only the Medical and High School (HS) groups filled out the closed-form questionnaire survey. The two groups' responses are analyzed and compared in Table 3.

Table 3. Comparison of Medical and High School groups in closed form survey

Items/Avg(Std)	Medical	High Sch.	Prob. of t-test
Feel the inquiry learning very difficult	3.74(0.80)	3.45(0.66)	0.006*
Demonstrate clear phenomena	3.34(1.01)	4.13(0.89)	7.3E-10**
Benefit conceptual understanding	4.02(0.77)	4.24(0.73)	0.020 ^{n.s.}
Be related to daily-life	2.99(1.03)	3.30(0.90)	0.022 ^{n.s.}
Cultivate thinking ability	4.03(0.73)	4.40(0.70)	3.8E-04**
Promote learning interest	3.23(1.10)	3.98(0.83)	4.2E-08**
Engage in solving the questions deeply	3.77(0.98)	4.30(0.85)	3.6E-05**

^{n.s.}: non significant at $p=0.01$; * : significant at $p<0.01$; ** : significant at $p<0.001$

Table 3 shows that the Medical students felt that the inquiry learning was more difficult than the High School group, which appears to be in conflict with their physics background. However, the students' self-evaluation is coherent with their performance in the inquiry activity. In addition, the High School group was found to be more positive regarding 1) demonstrate clear phenomena, 2) cultivate thinking ability, 3) promote interest in learning physics, and 4) engage in solving the questions.

In addition, all of the participants' comments on the open-form questionnaire survey. In the students' positive comments regarding their learning outcomes, i.e., thinking, concepts, and interest, both cognitive and affective outcomes appear to be interwoven rather than discretely stated. For example, "The questions are so difficult because I haven't touched physics for too long. However, it is great to work out my brain again, which is the least thing I have done since entering Medical School". "It feels like practicing a *reverse* way of thinking. The questions appear to be similar to usual problems, but train us in both forward and reverse ways of reasoning".

Besides, there were 16%~29% of the last three groups who acknowledged their appreciation of the providence of preview and/or review of the physics principles. For example, "I was completely lost when solving the first two units. However, after the professor's reviewing (of the solutions of unit 2), I then understood how to solve the 3rd unit". In addition to the preview/review, the students praised other forms of teaching scaffolding, including disconnecting one bulb to observe the variation of illumination and the arrangement of the group discussion.

In contrast to the positive comments, however, the students also expressed their criticism of and complaints about the inquiry activity. The students noted that the questions were too difficult to answer; however, the percentages decreased in the latter two phases. The comments of difficulty were associated with the absence of any preview, insufficient hints for the questions, or the novelty of the design. Besides, some of former two phases commented on the vague phenomena and/or confusion of alternative connections, which may become a major barrier to the learning outcomes. Last, while the last two phases performed better than the first two groups, 5%~18% of the groups still expressed the demand for more time to think. For example, one student suggested that the review of the answers be slower, and that more details be provided as it was difficult to completely absorb so much information in a short period of time.

5. Discussion and Conclusion

The results disclose that the more sophisticated the teaching scaffolding is, the better performance the students achieve in the inquiry-based activities. Student performance in the inquiry is also found to be positively associated with their attitudes towards the learning activities. These findings echo Barman's (2002) assertion that student inquiry requires the providence of explicit illustration regarding effective learning strategies.

Due to the lack of scaffolding in reviewing the units taught, students with superior academic background may not be able to demonstrate their prior knowledge advantage when performing novel tasks, such as "reverse reasoning" of the circuit diagrams. Contrarily, because of receiving thorough review of the solutions in the units taught, the students without strong physics concepts may be able to outperform their counterparts in addressing inquiry-based questions. These study findings are congruent with the notion of ZPD proposed by Vygotsky (1978) that the essentiality of providing scaffolding to learners is to help them conquer the task which is originally beyond their capacity. In addition, coherent with Engelhardt and Beichner's (2004) finding, reasoning realistic connections (task 2) from a schematic circuit diagram (task 1) was found to be very challenging. For task 2, repeated practice and reviewing was highly demanded (Airey and Linder, 2009).

The findings are also consistent with the concept suggested by Wood *et al.* (1976) and Kock *et al.* (2013) that learning tasks should be divided into manageable components. Therefore, when designing the worksheets, the tasks in prior questions must serve as the prerequisite for those of the latter, and the context of the latter units may gradually increase in their complexity. Such “step by step” progression is found to be positively acknowledged by the students in general.

Likewise, the provision of intensive teaching scaffolding is also found to be positively associated with student performance and learning attitudes, which is particularly favourable for those with comparatively weaker academic background, such as the High School group in the current study. Specifically, the comprehensive scaffolding appears to have helped them gain more conceptual understanding of electric circuits and also higher motivation to engage in the inquiry-based learning. The findings confirm the importance of maintaining student motivation to sustain their commitments to learning (Blumenfeld *et al.*, 1991).

To effectively implement the student-based inquiry learning, the current study reveals that the following teaching scaffoldings are pivotal: 1) requiring students to preview the lesson content in order to refresh their prior knowledge of electricity, 2) specifying the illumination distribution of the bulbs to ensure valid reasoning skills, 3) providing more clues by means of disconnecting one bulb, and 4) reviewing the solutions of the prior units taught to gradually grasp the strategies of reasoning. Although the above tips appear to be basic and simple, it may take the instructor multiple trial-and-error attempts to fulfil the teaching objectives as they are often overlooked by instructors when designing and implementing inquiry-based instruction, especially in the early phases. However, the repeated learning cycle of reasoning and reviewing may not always be favourable. The spiral teaching and learning sequence may be perceived as redundant for some simple tasks, such as drawing circuit diagrams (question 1).



This study emphasizes the following three points. Firstly, seeing is not learning, since 1) the phenomena may not provide enough clues for valid reasoning, and 2) students may not possess the required reasoning skills, tools, and knowledge to cope with the demanding tasks, even if they have “observed” sufficient signals. Secondly, a strong academic background may not be continuously advantageous for successfully solving inquiry-based questions in that 1) their prior knowledge may have faded, and 2) they may confront unfamiliar tasks requiring novel strategies which they did not experience previously. This highlights the importance of providing instructional scaffolding to help students overcome unexpected situations. Thus, the difficulties of physics inquiry may not only be determined by the complexity of the contexts but also the novelty of the tasks. Lastly, to grasp the optimal degree of teaching scaffolding, repeated designing, implementation, reflection, and modification in a long-term manner is crucial, coherent with the earlier contention of Beatty *et al.* (2006) and Chang (2011).

Reference

- Airey, J. & Linder, C. (2009). A disciplinary discourse perspective on university science learning: Achieving fluency in a critical constellation of modes,” *J. Res. in Sci. Teach.* 46(1), 27–49.
- Barman, C. (2002). How do you define inquiry? *Science and Children*, 40(2), 8-9.
- Barron, B. J. S., Schwartz, D. L., Vye, N. J., Petrosino, A., Zech, L., Bransford, J. D., & The Cognition and Technology Group at Vanderbilt. (1998). Doing with understanding: Lessons from research on problem- and project-based learning. *J. Learn. Sci.* 7, 271-311.
- Beatty, I.D., Gerace, W.J., Leonard, W. J., and Dufresne, R. J., (2006). “Designing effective questions for classroom response system teaching,” *Am. J. Phys.* 74 (1), 31-39.
- Bell, B., and Cowie, B. (2001). The characteristics of formative assessment in science education, *Sci. Educ.* 85, 536–553 (2001)
- Blumenfeld, P. C., Soloway, E., Marx, R., Krajcik, J. S., Guzdial, M., & Palincsar, A. (1991). Motivating project-based learning: Sustaining the doing, supporting the learning. *Educa. Psy.* 26, 369-398.
- Chang, W. (2011). Integrating electrostatics with demonstration and interactive teaching. *Am. J. Phys.* 79(2), 226-238.
- Chang, W., & Bell, B. (2002). Making content easier or adding more challenge in year one university physics? *Res. in Sci. Edu.* 32(1), 81-96.

- Ding, L., Chabay, R., Sherwood, B., and Beichner, R. (2006). Evaluating an electricity and magnetism assessment tool: Brief electricity and magnetism assessment. *Physical Review Special Topics- Physics Education Research*, 2(1) 010105(7).
- Duit, R., & Treagust, D.F. (1995). Students' conceptions and constructivist teaching approaches. In B.J. Fraser & J.W. Walberg (Eds.), *Improving Science Education*. The University of Chicago Press.
- Edelson, D.C., Gordin, D.N., & Pea, R.D. (1999). Addressing the challenges of inquiry-based learning through technology and curriculum design. *J. Learn. Sci.* 8(3&4), 391-450
- Engelhardt, P. V., & Beichner, R. J. (2004). Students' understanding of direct current resistive electrical circuits. *Am. J. Phys.* 72(1), 98-115.
- Kock, Z. J., Taconis, R., Bolhuis, S., & Gravemeijer, K. (2013). Some key issues in creating inquiry-based instructional practices that aim at the understanding of simple electric circuits. *Res. in Sci. Edu.* 43, 579–597.
- McDermott, L. (1993). "How we teach and how students learn – A mismatch?," *Am. J. Phys.* 61 (4), 295-298.
- Millar, R., and Beh, K. L. (1993). "Students' understanding of voltage in simple parallel electric circuits," *Int. J. Sci. Educ.* 15(4), 351–361.
- O'Loughlin, M. (1992). Rethinking science education: Beyond Piagetian constructivism toward a sociocultural model of teaching and learning. *J. Res. in Sci. Teach.* 29, 791-820.
- Kock, Z. J., Taconis, R., Bolhuis, S., & Gravemeijer, K. (2013). Some key issues in creating inquiry-based instructional practices that aim at the understanding of simple electric circuits. *Res. in Sci. Edu.* 43, 579–597.
- Roth, W.M., McRobbie, C.J., Lucas, K.B., & Boutonne, S. (1997). Why may students fail to learn from demonstrations? A social practice perspective on learning in physics. *J. Res. in Sci. Teach.* 34(5), 509-533.
- Sebastia, J.M. (1993). Cognitive mediators and interpretations of electric circuits," in *Proceedings of the Third International Seminar on Misconceptions and Educational Strategies in Science and Mathematics* (Misconceptions Trust, Ithaca, New York.)
- Shipstone, D. M., (1984). A study of children's understanding of electricity in simple DC circuits," *Eur. J. Sci. Educ.* 6(2), 185–198.
- Vygotsky, L.S., (1978). *Mind in Society: The Development of Higher Psychological Processes*, Cambridge, MA: Harvard University Press.
- Wood, D., Bruner, J. & Ross, G., (1976). The role of tutoring in problem solving. *J. Chi. Psy. Psys.* 17, 89–100.

Appendix A: The phenomena, the tasks, and the answers of unit 1 and unit 3

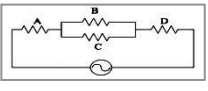
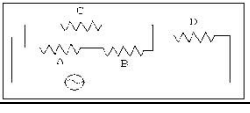
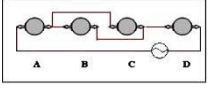
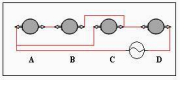
Task	Unit 1	Unit 3
The phenomenon		
1. drawing circuit diagram		
2. drawing realistic connections		
3. $I_A : I_B : I_C : I_D$	2 : 1 : 1 : 2	1 : 1 : 2 : 3
4. $P_A : P_B : P_C : P_D$	4 : 1 : 1 : 4	1 : 1 : 4 : 9
5. If each bulb is marked 100W, what is the power of bulb D?	16W	36W
6. rearrange resistance ratio to illuminate equally	$I_A : I_B : I_C : I_D = 2 : 1 : 1 : 2$ $\Rightarrow P = I^2 R \Rightarrow R \propto 1/I^2$ $\therefore R_A : R_B : R_C : R_D = 1 : 4 : 4 : 1$	$\because P = I^2 R \Rightarrow I_c^2 R_c = I_A^2 R_A \text{----- (1)}$ $V_c = V_A + V_B \Rightarrow I_c R_c = I_A (2R_A) \text{---(2)}$ $(1) \& (2) \Rightarrow I_A : I_B : I_C : I_D = 2 : 2 : 1 : 3$ $\therefore P = I^2 R \Rightarrow R_A : R_B : R_C : R_D = 9 : 9 : 36 : 4$

Integrated STEM in Secondary Education: a Case Study

Jolien De Meester¹, Heidi Knipprath², Jan Thielemans³, Mieke De Cock⁴,
Greet Langie⁵, Wim Dehaene¹

¹ KU Leuven Dept. of Electrical Engineering ESAT, Leuven (Belgium)

² KU Leuven Research Inst. for Work and Society HIVA, Leuven (Belgium)

³ Secondary School Heilig Graf, Turnhout (Belgium)

⁴ KU Leuven Dept. of Physics & Astronomy, Leuven (Belgium)

⁵ KU Leuven Dept. of Mechanical Industrial Engineering, Leuven (Belgium)

Abstract

Despite many opportunities to study STEM (Science, Technology, Engineering & Mathematics) in Flemish secondary education, only a minority of pupils are actually pursuing STEM fields in higher education and jobs. One reason could be that they do not see the relevance of science and mathematics. In order to draw their pupils' interest in STEM, a Belgian school started a brand-new initiative: the school set up and implemented a first year course that integrates various STEM disciplines, hoping to provide an answer to the question pupils often ask themselves about the need to study math and science. The integrated curriculum was developed by the school's teachers and a STEM education research group of the University of Leuven. To examine the pupils' attitude towards STEM and STEM professions and their notion of relevance of STEM at the end of this one-year course, a post-test was administered to the group of pupils who attended the integrated STEM course (the experimental group) and to a group of pupils that took traditional, non-integrated STEM courses (the control group). The results reveal that attending the integrated STEM course is significantly related to pupils' interest in STEM and notion of relevance of STEM. Another post-test was administered only to the experimental group to investigate pupils' understanding of math and physics concepts and their relation when taught in an integrated way. The results reveal that the pupils have some conceptual understanding and can, to a certain extent, make a transfer of concepts across different STEM disciplines. However, the test results did point out that some additional introductory training in pure math context is needed.

Keywords

integrated STEM, kinematics, secondary education, conceptual understanding, interest, attitude

1. Introduction

In secondary education in Flanders (Belgium) pupils have a variety of options to study one or more disciplines of STEM (Science, Technology, Engineering, Math). This STEM education is often considered to be of relatively high quality, since Flemish pupils perform above average in international assessment studies (De Meyer et al, 2013 & 2014). Although the educational environment seems beneficial for Belgian pupils, they're often not intrinsically motivated for STEM (OECD, 2013).

A study that investigates the relevance of science education (ROSE), points out that 15 year old pupils feel that they can personally influence what happens in the environment, but that they don't think science and technology are tools that can be used to solve environmental problems (ROSE, 2010). One might ask whether this discrepancy and lack of motivation for STEM can be due to education. The ROSE-study seems to corroborate this assumption: in most European countries, youngsters rather disagree with the statement 'School science has shown me the importance of science for our way of living' (ROSE, 2010).

This indifference towards STEM education seems to result in a mismatch between the educational system and industry. To meet the need of the industry, too few people graduate with a STEM degree: in Flanders only 19.0 percent of the students in higher education. That is only half of the pupils that finish secondary school with a STEM diploma (41.1 percent). The decrease doesn't stop there; only six out of ten people with a STEM diploma actually apply for a STEM job (Van den Berghe & De Martelaere, 2012).

To stress the relevance of science and math, we think that it is important in the first place to show the interrelatedness between the STEM disciplines. While this seems obvious, it is not yet always done in the current Flemish educational system. This paper sheds light on an initiative, taken by a Flemish secondary school: a new study program in its first year, with a course ‘STEM’. This exploratory study is the first phase in testing our hypothesis that integration of STEM disciplines can provide an answer to pupils’ perception of missing relevance. Our research question was twofold: (1) Can we motivate pupils for STEM and STEM jobs and show them the relevance of STEM by teaching math and science in an integrated manner? (2) Can we teach them in this early stage of secondary education, in an integrated way, mathematical concepts like graphs, tables, formulas and functions, and physics concepts like position, velocity and acceleration?

The paper starts by situating the organisation of the new STEM initiative in the first year of secondary education and the curriculum development. We made a deliberate choice of three learning paths, which will be expanded throughout the six years of secondary education. The paper zooms in on the learning path Mechanics in the following section. To evaluate the impact of the new didactic approach, two post-tests were developed: one to examine pupil understanding of some of the STEM topics learned, and another one to verify the attitude of the pupils towards STEM after one year of STEM education. The paper discusses the research method and elaborates on the results in the next section. Finally, it ends with the conclusions that can be drawn from the results, and the future perspectives.

2. A new study program ‘STEM’

Organisation

In order to enhance the attitude of its pupils towards STEM, a school in Flanders (Belgium), set up a brand new study program, called ‘STEM’, in the first year of its secondary education. This program is organized next to the existing program, in the following referred to as ‘non-STEM’. Every course in the non-STEM program is instructed in the traditional non-integrated way. The pupils who opt for the study program STEM, are instructed integrated abstract STEM through a course of five hours a week. 21 pupils enrolled in this program in the academic year 2013-2014, amongst whom 5 girls. They form two groups, which are each instructed by two teachers at the same time. The teachers have different educational backgrounds, which facilitates integrated approaches. For the content of this course, the school’s teachers turned to the University of Leuven (Belgium) for support and cooperation.

Didactical approach

In the new study program, a new teaching/learning approach is practised, in which a high level of understanding of abstract science, math and technology is aspired, a competence within STEM literacy. Moreover, a key concept to achieve the goal of demonstrating the relevance of STEM for environment and society, is the integration of the different STEM-disciplines. This means that one of the learning goals is to show the interplay of STEM disciplines in their daily quest to address the burning issues of today’s society. The development of the curriculum is inspired by the ‘Making Learning Whole’ principle (Perkins, 2009). The idea is to keep a holistic view on the content that is to be instructed. For example: rather than to be silent about acceleration until the moment the pupils have finally learned how to calculate differentials, it makes much more sense to teach the concept of acceleration right after the concepts velocity and position are instructed. After all, acceleration is basically a prolongation of the previously seen concepts. Another way of practising this Making Learning Whole principle, is to let pupils work with *whole systems*, instead of just elaborating excessively on the small blocks of which these systems consist, without showing their purpose. For example: instead of telling pupils about sensors and flip-flops, what they look like and how they work, the pupils will learn much more while using these components to build a miniature train that makes actions based upon programmed decisions. In this approach, adapted to the age of the learners, every pupil can learn to play the whole game of engineering (Dehaene et al., 2013). Ultimately, this is how pupils learn to use abstractions like data, systems and processes, in order to design, analyse and validate a complete technical system.

Curriculum content

For the course STEM, we opted for three well considered learning paths: Mechanics, Programming and Design.

Mechanics offers a great way to operationalize and thus integrate some mathematical concepts like graphs, functions, variables and formulas. Some of these concepts can easily be approached intuitively or qualitatively in the context of kinematics. Through mechanics, pupils not only learn how to set up an

experiment, to measure and analyse data. They also learn to quantify what's going on in real life (e.g. continuous motion) and formulate a deliberate conclusion based on a table of data points, a graph or an expression. Moreover, representing information is one of the first steps in modelling, a competence we consider as important while 'doing STEM'. Pupils' design projects will often involve some kind of mechanical motion, another good reason for mechanics to be the scientific starter within the curriculum. In the scope of this paper, we will focus on the learning path Mechanics.

Programming, which demands logically and structured thinking, is an essential skill in a pupil's toolbox, since it provides him/her with the flexibility to handle all kinds of innovations in a responsible way, the entrance ticket to the increasing digital world. Furthermore, programming a robot adds an element of motivation to the integrated STEM.

Finally, *Design* is a part of integrated STEM that brings different kinds of math, science and technology disciplines together in the E of engineering. The key factor in purposeful design (Sanders, 2009) is the problem based dimension, in which pupils need to deploy their understanding of math, science and technology in order to solve the stated problem.

In the first year of the STEM course, the contents of these learning paths start with a basic package, taking into account the limited prior knowledge a 13 year old pupil possesses. We want to expand the content of the three learning paths for the six years of secondary school:

- The level of abstraction has to increase
- The degree of difficulty of math and science has to increase
- The amount of integrated science disciplines (other than physics e.g.) has to increase.

Teaching of the separate STEM courses, such as math, physics, chemistry and biology will be continued in the higher years too, to respect the pure nature of these disciplines as well. Nevertheless, the link to the integrated approach must be within reach for the pupils in any case.

3. Mechanics in the STEM course

Research has pointed out persisting difficulties for pupils in kinematics. In many cases, the understanding of kinematics concepts of graduating secondary school pupils turns out to be not sufficient in university STEM studies. Often, students mix up the concepts position and relative velocity, or the concepts velocity and acceleration (Trowbridge & McDermott, 1980 & 1981). In some cases, students are held back by the idea of using their math knowledge in a context of physics (Woolnough, 2000). Furthermore, because pupils in secondary school almost exclusively encounter graphs through the origin (0,0) in a kinematics context, they're often not able to calculate the slope of a random linear graph correctly (Wemyss & van Kampen, 2013). These research results were taken into account while developing the learning path of Mechanics and the appropriate exercises. By starting in an early stage with pupils whose study program traditionally doesn't address this topic yet, we hope to establish a thorough and sustainable understanding of kinematics and a mutual transfer of math and physics concepts.

First the pupils learn in an interactive way about ordered pairs, function expressions and graphs. In pairs they perform an experiment, in which one pupil runs with a barrier tape in his/her hand and the other places dots on the unrolling tape each second (Figure 1). The pupils analyse the resulting tapes afterwards based upon their observations during the real life experiment. This offers a very intuitive way of defining velocity as the covered distance over the time interval, as well as the concept of acceleration. Moreover, these phenomena can be demonstrated in an abstract yet visual way, as can be seen in the right hand side of Figure 1 (Vanden Bosch, 2008).

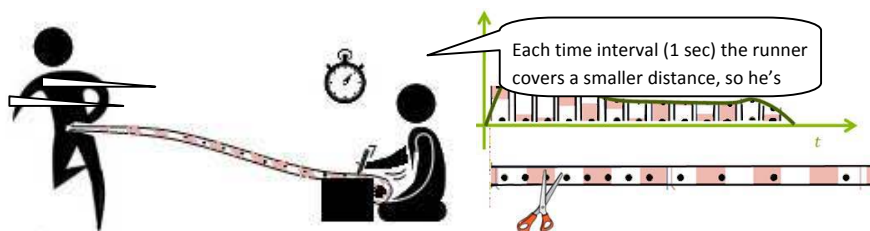

Figure 1. Experiment performed by the pupils (Vanden Bosch, 2008): one pupil runs, holding a barrier tape, the other one puts dots on the tape every second (left), they cut the barrier tape at the dots and place the bars next to each other in order to construct a graph (right)

Thorough practice in constructing and interpreting all kinds of abstract representations (graphs, formulas, tables) of different motions, helps the pupils in stating implications for real life, or vice versa. By studying the relation between the graphs of position, velocity and acceleration as a function of time, they even find out how to construct one graph based on the other one. Guided by their teacher, the pupils derive the formulas of a uniformly accelerated linear motion, in this way performing mathematical actions in a context of physics.

4. Research method

Our research concerned the effect of teaching STEM in an *integrated* manner: (1) can we as such motivate pupils for STEM and show them the relevance of STEM?, and (2) can we as such give them in this early stage of secondary education, some understanding of math concepts like graphs, formulas and functions and physics concepts like position, velocity and acceleration?

Participants

Two classes have been surveyed: the STEM class (experimental group) and a non-STEM class (control group). Pupils of both classes participate in the same non-STEM courses. Table 1 shows for both classes the weekly schedule of the non-integrated STEM courses. However, pupils enrolled in the STEM program are offered a course ‘STEM’ of five hours a week, which *does* integrate various STEM disciplines (math, physics and technique).

Table 1. Hours per week for each STEM course in the two study programs in the first year of general secondary education (Flanders, Belgium)

Course	STEM	non-STEM
Mathematics	5	6
Natural Sciences	2	2
Technique		2
STEM	5	

Five girls and 16 boys were enrolled in the STEM class, whereas 14 girls and 9 boys were enrolled in the non-STEM class. This difference in gender distribution indicates that boys are likely more interested in studying STEM than girls, and needs to be taken into account when interpreting our results.

Research design

To investigate the relationship between integrated STEM education and STEM literacy, we used a post-test only design. We measured *conceptual understanding in STEM* by means of a cognitive test focusing on mechanics. This test was offered to the pupils in the STEM class only because the non-STEM pupils were not exposed to STEM education concerning physics concepts. More in-depth research will be required to develop appropriate instruments allowing to compare pupils who are and pupils who are not exposed to integrated STEM education.

To investigate the relationship between integrated STEM education and *attitudes towards STEM*, we used a post-test design with a non-equivalent control group. Pupils in the STEM class and pupils in the non-STEM class filled in a survey containing 25 items.

Even though the rollout of an integrated STEM course required a lot of effort, it had to be done in a very short time period. We are aware that lack of a pre-test, which would allow to control for initial differences between pupils of the two groups, makes causal inferences rather difficult.

Instruments and analysis techniques

Cognitive test on mechanics

The cognitive test was a summative written evaluation on the topic of mechanics, as being one of the main learning paths within the integrated STEM course. It offers an objective way of assessing pupils’ conceptual understanding, transfer and integration of math and physics concepts. Spreaded over four exercises, 14 items were evaluated (see Table 3). The first exercise had five graphs with quotes, to be answered by ‘right’ or

‘wrong’. The aim was to evaluate the ability of the pupils to interpret graphs in a correct way, as shown e.g. in Figure 2.

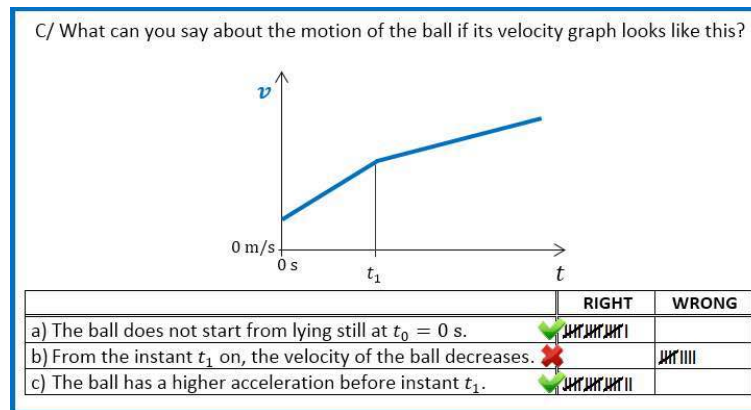

Figure 2. A question in the first exercise of the cognitive test: pupils had to cross either ‘right’ or ‘wrong’. (Here, the signs indicate the correct answers, correct answering pupils were tallied.)

The second exercise pictured the graph of the water tank level, gradually decreasing in time, to be transformed into a table of data points (Wemyss & van Kampen, 2013). The exercise checked if the pupils could deduce from the graph or table that the level was decreasing at constant speed, and whether or not the pupil used the formula of average velocity to calculate this speed. In the third exercise the pupils needed to use formulas and make calculations based on the description of a real life situation in order to construct the graphs of velocity and of position in time. In the second as well as in the third exercise the pupils’ ability of switching between different kinds of representation was evaluated. The last exercise verified if pupils were able to construct a graph based on a formula in a pure math context, e.g.: $y = 5(1 - x)$, and so make the transfer of what they learned in the integrated math-science context.

One person tallied the correct answers using a coding scheme (as e.g. in Figure 2). Per evaluated item (Table 3), the average percentage of correct answers was calculated over the different exercise questions, because each exercise question examined multiple items.

Survey on the attitude towards STEM

Pupils in both classes were requested to fill in a survey with 25 items (4-point Likert scale), measuring various dimensions of their attitude towards STEM including cognitive beliefs, affective states and behaviour (cf. De Winter et al., 2010; van Aalderen-Smeets et al., 2011). Based on factor analysis and 23 items, in the end five indexes were produced: general interest towards STEM, job expectations with regard to STEM, belief in gender differences, seeing the relevance of STEM and progress in understanding STEM. The reliability coefficient, Cronbach’s α , of the five indexes varies between .55 and .96 (Table 2).

With regard to attitudes toward STEM, we applied linear regression analysis (OLS) to investigate to what extent pupils’ attitude toward STEM can be predicted by enrolment in a STEM class, controlled for gender (Table 4). Standardized coefficients are presented and considered to be statistically significant if the p -value is below .05.

Table 2. Items and reliability statistics (Cronbach’s alpha) for five indexes measuring pupils’ attitude towards STEM

Indexes	Reliability
General interest towards STEM	.671
Job expectations with regard to STEM	.859
Belief in gender differences with regard to STEM	.956
Seeing the relevance of STEM	.663
Progress in understanding STEM	.555

5. Results

Cognitive test on mechanics

The cognitive test in the STEM class exhibited some clear results, as can be seen in the scores of the evaluated items in Table 3. They performed rather well at interpreting graphs, on average the right or wrong quotes were assessed correctly by 60.0 percent of the pupils.

In general, the pupils showed some flexibility in switching between different forms of representation, more specifically graphs and tables (63.0 percent). Formulas and non-linear graphs on the other hand seemed to be more difficult for them to deal with or to analyse. Finally, we discovered that the pupils were not able to use the concepts they learned in the integrated context of math and physics, in a pure math context: only 16.0 percent of the pupils managed to construct a graph of a pure math function (Table 3).

Table 3. Some of the items examined in the cognitive test and the percentage of correct answers by the STEM pupils (N = 21) (Graphs, tables or formulas are referred to as abstract representations)

Item	Correct answer in g (%)
Interpreting graphs correctly	60.0
Interpreting abstract representations to physical reality	63.0
Translating physical reality into abstract representation	9.4
Switching between forms of representation: graph to formula	7.4
Switching between forms of representation: formula to graph	11.9
Switching between forms of representation: graph to table	63.0
Calculating correctly the slope $\Delta x/\Delta t$	28.4
Transfer of concepts, e.g. formulas: integrated to pure math context	16.0

Survey on the attitude towards STEM

The results in table 4 indicate that enrolment in a STEM class is positively related to four of five indexes measuring attitudes towards STEM: general interest in STEM, job expectations, relevance of STEM, and progress in understanding (model 1). Although there is a clear difference in gender distribution between the STEM class and the non-STEM class, the relationship between enrolment in the STEM class and pupils' attitudes remains statistically significant even when controlling for gender (model 2).

Table 4. The five indexes of attitude towards STEM, regressed on model 1: enrolment in the STEM class, model 2: gender, and model 3: the interaction between gender and enrolment (standardized regression coefficients)

	General interest in STEM			Job expectations			Belief in gender differences		
	model 1	model 2	model 3	model 1	model 2	model 3	model 1	model 2	model 3
STEM	.603***	.464***	.206	.535***	.399**	-.183	.145	-.159	.086
Male		.325*	.208		.351*	.020		.676***	.890***
STEM x male			.212			.872***			-.442
R ²	.364	.450	.473	.286	.391	.555	.021	.385	.426

Note: N = 40 - 41, *** p < 0.001, ** p < 0.01, * p < 0.05

	Seeing the relevance of STEM			Progress in understanding STEM		
	model 1	model 2	model 3	model 1	model 2	model 3
STEM	.362*	.359*	-.120	.354*	.220	-.039
Male		.008	-.286		.346*	.159
STEM x male			.733*			.423
R ²	.131	.131	.242	.125	.227	.266

Note: $N = 39 - 42$, *** $p < 0.001$, ** $p < 0.01$, * $p < 0.05$

Gender too is significantly related to four of five indexes measuring attitudes towards STEM: general interest in STEM, job expectations, belief in gender differences, and progress in understanding (model 1). Boys seem to be interested in STEM more than girls, believe more than girls to make progress in understanding STEM issues over the year, and believe more often than girls that boys are better in STEM than girls (model 2).

In case of job expectations and relevance of STEM, the interaction term between enrolment in STEM and gender (model 3), is statistically significant. Boys and girls in the non-STEM class showed equal interest in STEM jobs. In contrast, there is a large gender gap in the STEM class: girls in the STEM class showed less interest in STEM jobs than any pupil of the non-STEM class, whereas boys in the STEM class showed more interest in STEM jobs than all other pupils. Likewise, a similar gap exists in the STEM class between boys and girls with regard to seeing the relevance of STEM. This gender gap is much larger than in the non-STEM class.

Discussion and conclusion

In this paper we discussed an integrated STEM course in a Flemish secondary school, newly developed to show the relevance of STEM for real life, by introducing the STEM disciplines in an integrated way. Two post-test designs (one with a non-equivalent control group) were used to evaluate the potential effect of integrated STEM education. Although we need to be careful about making causal inferences, we observed that some interesting results emerged.

Pupils who were enrolled in the STEM class can switch between different kinds of representations (graph to table or to real life), construct and deduct simple graphs, the first step in learning how to make abstraction and models. However, manipulating mathematical formulas is still perceived as a difficult topic that should anyhow be approached by an integrated as well as a non-integrated way. Therefore, the new batch of STEM pupils will receive some required minimal initial training in *pure math context, prior to the integration* in a scientific context.

In general, STEM pupils show a more positive attitude towards STEM than pupils enrolled in a non-STEM class, even taken into account the fact that less girls are enrolled in the STEM class than in the non-STEM class. Although we were not able to administer a pre-test and thus cannot make any causal inferences, we do find it remarkable that, regarding job expectations and relevance perception, the gender gap in the STEM class is larger than in the non-STEM class, indicating that at least the girls' interest and perceptions likely did not improve much after being exposed to integrated STEM education. This is important to keep in mind when implementing integrated STEM education. Therefore, the learning path of Mechanics will be embedded more in different contexts, e.g. biology (Klein & Sherwood, 2005).

References

- Dehaene, W., Decuyper, J., Goddé, N. (2013). When Engineering becomes Children's playground. *Proceedings of the 41st SEFI Conference*.
- De Meyer, I., Warlop, N., Van Camp, S. (2013). Wiskundige geletterdheid bij 15-jarigen – Vlaamse resultaten van PISA 2012. Universiteit Gent vakgroep Onderwijskunde.
- De Meyer, I., Warlop, N., Van Camp, S. (2014).. Probleemoplossend vermogen bij 15-jarigen – Vlaamse resultaten van PISA 2012. Universiteit Gent vakgroep Onderwijskunde.
- De Winter, V., Van Cleynenbreugel, C., Buyse, E., & Laevers, F. (2010). Leerkrachtprofielen en onderwijs in Wetenschap en Techniek in het basisonderwijs. Werkzame bestanddelen voor

- deskundigheidsbevordering en attitudeverandering. *VTB-Pro aanvullend onderzoek 2009-2010. Eindverslag*. Leuven: Katholieke Universiteit Leuven, Expertisecentrum Ervaringsgericht Onderwijs.
- Klein, S.S., Sherwood, R.D. (2005). Biomedical Engineering and Cognitive Science as the Basis for Secondary Science Curriculum Development: A Three Year Study. *School Science and Mathematics* **105**, 8. Vanderbilt University.
- Perkins, D. (2009). *Making learning whole – How seven principles of teaching can transform education*. San Francisco: Jossey-Bass.
- Sanders, M. (2009). STEM, STEM Education, STEMmania. *The Technology Teacher*, 20-26.
- Schleicher, A., Davidson, M. (2013). Programme for International Pupil Assessment (PISA) Results from PISA 2012 – Belgium: Key Findings. OECD.
- Sjøberg, S., Schreiner, C. (2010). The ROSE project. University of Oslo.
- Trowbridge, D.E., McDermott, L.C. (1980). Investigation of pupil understanding of the concept of velocity in one dimension. *Am. J. Phys.* **48**(12), 1020-1028.
- Trowbridge, D.E., McDermott, L.C. (1981). Investigation of pupil understanding of the concept of acceleration in one dimension. *Am. J. Phys.* **49**(3), 242-253.
- Van Aalderen-Smeets, S. I., Van der Molen, J. H. W., & Asma, L. J. F. (2012). Primary teachers' attitudes toward science: a new theoretical framework. *Science Education* **96**(1), 158-182.
- Van den Berghe, W., De Martelaere, D. (2012). Kiezen voor STEM. VRWI Vlaamse Raad voor Wetenschap en Innovatie.
- Vanden Bosch, E. (2008). *Sport onder de loep – De snelsten allertijden*. RVO-society, Leuven, Belgium.
- Wemyss, T. & van Kampen, P. (2013). Categorization of first-year university pupils' interpretations of numerical linear distance-time graphs. *Phys. Rev. ST – Phys. Educ. Res.* **9**, 010107.
- Woolnough, J. (2000). How do pupils learn to apply their mathematical knowledge to interpret graphs in physics. *Res. Sci. Edu.* **30**, 259.

Affiliation and address information

Jolien De Meester
MICAS – STEM research group
Department of Electrotechnics, ESAT
Catholic University of Leuven
Kasteelpark Arenberg 10, Room 91.06
B-3001 Leuven, Belgium
e-mail: jolien.demeester@esat.kuleuven.be

A Quantitative Method to Analyse an Open Answer Questionnaire: a Case Study about the Boltzmann Factor

Onofrio Rosario Battaglia¹, Benedetto Di Paola²

Dipartimento di Fisica e Chimica, Università degli Studi di Palermo, Italy

Dipartimento di Matematica e Informatica, Università degli Studi di Palermo, Italy

Abstract

This paper describes a quantitative method to analyse an open answer questionnaire. Student responses to a specially designed written questionnaire are quantitatively analysed by not hierarchical clustering k-means method. Through this we can characterise behaviour students with respect their expertise to formulate explanations for phenomena or processes and/or use a given model in the different context. The physics topic is about the Boltzmann Factor, which allows the students to have a unifying view of different phenomena in different contexts.

Keywords

Quantitative analysis, k-means method, Boltzmann factor, explanation skills.

1. Introduction

Extensive qualitative research involving open answer questionnaires as well as standardized multiple-choice tests provided instructors tools to probe their students' conceptual knowledge of various fields of physics. Many of such studies examined the consistency of students' answers in a variety of situations, or problems where the underlying physical systems are found similar from an expert point of view. In these last years some papers tried to develop more detailed models of the reasoning consistency of the student populations tested or to subdivide a sample of students into intellectually similar subgroups. Bao and Redish (Bao & Redish, 2006) introduced a framework, model analysis, for exploring the structure of the consistency of the application of student ability by separating a group of students into intellectually similar subgroups. They apply qualitative research to establish a quantitative representation framework by analysing students' alternative knowledge and the probabilities for students to use such knowledge in a range of equivalent contexts. Their method provides a way to analyse research-based multiple choice questions, by integrating qualitative and quantitative methods where, results of qualitative research are used as the basis for the theoretical assumptions to be employed in the data analysis in order to evaluate the potential causal pathways for the inferential analysis as well as the issue of context dependence.

The problem of taking a set of data and separating it into subgroups where the members of each subgroup are more similar to each other than they are to members not in the subgroup has been extensively studied through the statistical method of cluster analysis. Such a analysis method has been previously used to group and characterize student responses to written questions about two-dimensional kinematics (Witmann, 2002) as well as multiple-choice tests (Ding and Beichner, 2009). Such authors outline that the power of cluster analysis lies in the clusters arising from the data and possibly uncovering unexpected relationships between student responses. In fact, it is well acknowledged that there are inherent difficulties in the classification of student responses in the case of open answer questionnaires. Very often strong bias leads to the result that the categories picked out may tend to find those groups of students that the researcher is already looking for.

Cluster analysis can separate students into groups that can be recognized and characterized by common traits in students' answers without any prior knowledge on the part of the researcher of what form those groups would take (unbiased classification). However, it must be taken into account that the defined groups have to reasonably make sense to a researcher, and the probabilistic nature of the methodology.

A recent paper (Stewart et al., 2012) analyses the evolution of student responses to seven contextually different versions of two Force Concept Inventory questions, by using a model analysis for the state of student ability and a clustering method in characterizing the student distribution answers. The paper shows that the clustering algorithm (k-means clustering) is an efficacious method of examining the subgroup structure of student understanding and produced significant subgroup population fractions. The authors

conclude that the k-means algorithm is an effective mechanism for extracting the underlying subgroups in student data and that additional insight may be gained from a carefully analysis of clustering results.

Cluster analysis can be achieved by various algorithms that differ significantly in their notion of what constitutes a cluster and how to efficiently find them. Notions of clusters include groups with small distances among the cluster members, dense areas of the data space, intervals or particular statistical distributions. The appropriate clustering algorithm and parameter settings depend on the individual data set and intended use of the results.

Clustering methods can be roughly distinguished as hierarchical clustering or centroid-based clustering (k-means clustering). The first category of algorithms is based on the core idea to build a binary tree of the data that successively merges similar groups of points and by visualizing this tree a useful summary of the data can be provided. Data are consequently connected to form clusters based on their distance. The second category of algorithm partitions the data space into a structure known as a Voronoi diagram (a number of regions including subsets of similar data). In this paper we want describe, just, the second one method. In particular we want analyse an open answer questionnaire by using the k-means method to obtain typical behaviours showed of our sample of students in relation to Boltzmann Factor topic.

2. Theoretical framework of data analysis

Open ended questions on questionnaires often offer insights or issues not captured in closed questions. However, coding answers to open-ended questionnaires can be harder than coding close-ended, or multiple choice, ones. This is mainly due to the fact that in open-ended questionnaires the researchers have to take into consideration all possible answers to the questions, in contrast to the other cases, where a limited list of possible answers to each item is already provided. Generally, techniques developed for analysing qualitative data are used to analyse and code the responses to open ended questions. Researchers carefully read responses so to examine patterns and trends and to find common themes emerging from them. Then, these themes, resuming the different trends found in the responses, are developed in a number of categories, that can be considered the typical "answering strategies" put into action by students when fronting the questionnaire items. Therefore, it is possible to include the whole set of answers given to the questionnaire in a limited number of answering strategies, making easier the subsequent coding.

It is often advisable that more than one researcher performs the search for patterns and trends in student answers, and then the whole group of researchers contrast and compare their own findings, in order to reach a consensus of a common table of student answering strategies to be used for the subsequent study. This study starts from the careful re-reading of each student responses and the coding of these responses in the answering strategies previously built.

If m answering strategies are found in total, each student can be identified by an array, a_i , composed by m components 1 and 0, where 1 means that the student used a given answering strategy to respond to an item, and 0 means that he/she did not use it. If we have n student that answered the questionnaire, a $m \times n$ binary matrix (the "matrix of answers") can be built. This matrix is modelled on the one shown in Table I. In it, the columns report the n student arrays, a_i , and the rows represent the m components of each array, i.e. the m answering strategies.

Table 1. Data matrix for analysis. The n students are indicated as S_1, S_2, \dots, S_n , and the m answering strategies as AS_1, AS_2, \dots, AS_m .

Strategy	Student					
	S_1	S_2	S_n	
AS_1	1	
AS_2	1	
...	0	
AS_5	1	
...	0	
AS_m	0	

For example, let us say that student S_1 used answering strategies AS_1, AS_2 and AS_5 to respond to the questionnaire questions. Therefore, S_1 column in Table I will contain the binary digit 1 in the three cells corresponding to these strategies, while all the other cells will be filled with 0.

The matrix depicted in Table I contains all the information needed by the researcher to describe the behaviour of students with respect to the subjects dealt with the questionnaire items. However, it needs some elaboration in order to make this information understandable. Often, Cluster Analysis (Ding and Beichner, 2009) is used when one wants to classify student behaviour in different groups, or clusters.

Cluster Analysis (CLA) is defined as the task of grouping a set of elements so that elements in the same group are more alike, in a sense or another, to each other than to elements included in other clusters. Introduced in Psychology by R.C. Tyron in 1939 (Tryon, 1939), CLA has been the object of research interest since the beginning of the 60s of the last century, with a first systematic use due to Sokal e Sneath (Sokal and Sneath, 1963). Applications of techniques related to CLA are common in many fields, including informatics, biology, medicine, archaeology Econophysics and market research. Whenever it is necessary to classify a large amount of information into distinguishable groups, CLA is an effective and essential method. For example, in market research it is important to characterize the key elements of decision-making processes of business strategies like characteristics, needs and behaviours of buyers. These techniques allow the researcher to locate, within a set of objects of any nature, subsets, or clusters, which have a strong tendency to be homogeneous "in some sense". The result of the analysis should, in line with the criteria chosen, highlight a high homogeneity within the group (intra-cluster) and high heterogeneity between groups (inter-cluster).

The starting point of the analysis of the groups is the availability of n data, each composed of t variables. Such data can be represented in the form of a $n \times t$ matrix. CLA techniques are exploratory ones, which do not necessarily require a-priori assumptions about the data, but need to actions and decisions to be taken before, during and after analysis. Particularly important are the selection of variables, the choice of criteria of similarity (distance) between the data, the choice of clustering techniques and the selection of the number of groups to obtain, and the evaluation of the found solution and the choice between possible alternative solutions. At any rate, it is important to bear in mind that different choices can lead to results separate and somehow arbitrary (as they strongly depend on the criteria used for the selection of the data). Subjectivity is common to all multivariate analysis methods, typical of the processes of reduction and controlled simplification of information.

In our case the student groups can be analysed in order to deduct their distinctive characteristics and studied to find similarities and differences between them.

In the literature (Wittman, 2002) it is possible to find examples of studies that find clusters of student, by means of specific procedures, that will be discussed in the following. Then each cluster is characterized by means of a careful read of the typical trends in answers of the students that are part of the cluster. Other studies (Fazio et al., 2013; Fazio et al., 2012) instead find clusters of student by comparing each student (i.e. the m -component array containing his/her answering strategies) with researcher-built arrays, representing ideal profiles of student behaviour. These profiles are often known from previous research and the related arrays are characterized by well-defined answering strategies.

2.1 Distance indexes

The clustering procedures need the definition of new quantities that are used to build the clusters, as, for instance, the "similarity" or "distance" indexes. These indexes are defined by starting from the $m \times n$ binary matrix discussed above.

The similarity between two elements is often expressed in the literature by taking into account the distance, $D(a_i, a_j)$, between them (that actually expresses their "dissimilarity", in the sense that the higher the distance between the elements, the lower is their similarity).

The distance index is often defined by starting from the Pearson's correlation coefficient, R . It allows the researcher to study the correlation between two elements, i and j , of a set, but the related variables must be numerical.

If we want to deal with two elements identified by non-numerical variables (for example, the arrays a_i and a_j containing the binary coding of answers of students i and j , respectively), we can use a modified form of R , defined in terms of the properties of the elements (i.e. the numbers of 1's and 0's in the array). A possible definition we propose is a "modified Pearson's coefficient" (Tumminello et al. 2011):

$$R_m(a_i, a_j) = \frac{n_p(a_i \cap a_j) - \frac{n_p(a_i)n_p(a_j)}{N_p}}{\sqrt{n_p(a_i)n_p(a_j) \left(\frac{N_p - n_p(a_i)}{N_p} \right) \left(\frac{N_p - n_p(a_j)}{N_p} \right)}}$$

where $n_p(a_i)$, $n_p(a_j)$ are the number of properties of a_i and a_j that we want to take into account, respectively (the numbers of 1's or 0's in the arrays a_i and a_j , respectively), N_p is the total number of properties to study (in our case, the m possible answering strategies) and $n_p(a_i \cap a_j)$ is the number of properties common to both a_i and a_j (the common number of 1's or 0's in the arrays a_i and a_j).

The choice of the type of metrics to use for the distance calculations is often complex and depends on many factors. If we want that two elements a_i and b_j , negatively correlated, are more dissimilar with respect to two elements positively correlated (as it is often advisable in research in education), a possible definition of the distance between a_i and b_j , making use of the modified correlation coefficient, $R_m(a_i, b_j)$, is:

$$D(a_i, b_j) = \sqrt{1 - R_m(a_i, b_j)}$$

This definition is often used in research in Econophysics, where it is common to compare the behaviour of real stocks traded in financial markets, trying to group them in clusters on the basis of their mutual likeness. It is an Euclidean metrics (Gower, 1966; Leish, 2005) as it is needed to represent the clusters in graphical form.

Once a metric is chosen, a distance between two elements equal to zero means that they are completely similar, while a distance equal to 1 shows that the elements are completely dissimilar. It is, then, possible to construct a new matrix, containing all the distances between the elements of the set. It clearly has the main diagonal composed by 0s (the distance between an element and itself is zero) and it is symmetrical with respect to the diagonal.

2.2 K-means method

Non-hierarchical clustering is used to generate grouping of a set of elements by partitioning it and producing a smaller set of non-overlapping clusters having no hierarchical relationships between them. Starting from an initial classification, elements are transferred from one cluster to another or swapped with elements from other clusters, until no further improvement can be made. Various algorithms can be used to build the clusters. Among the currently used ones we consider the *k-means*, first proposed by MacQueen in 1963 (MacQueen, 1963)

In the k-means algorithm, the starting point is the choice of the number of clusters one wants to populate and of an equal number of "seed points", randomly chosen between the elements of the dataset. The elements are, then, grouped on the basis of the minimum distance between them and the seed points. The part of a given cluster (the elements of a given cluster) is used to find a new point, representing the average position of the spatial distribution of the cluster elements. This is done for each cluster and the resulting points are defined the cluster *centroids*. The process continues by again grouping each set elements on the basis of the minimum distance between them and the cluster centroid and re-calculating the average positions of the elements of the new clusters (i.e. the new cluster centroids). The iteration ends when the new centroids have the same position of the old ones. The spatial distribution of the set elements can be represented in a two-dimensional space, originating what is known as the k-means graph.

Each centroid defines its cluster and can be used to characterize it. Particularly, if we are able to find an array C_k , of the same dimension of the ones associated to the real cluster elements, a_i , (i.e. the m answering strategies to the questionnaire) and composed by 0 and 1 values, we can consider it as a new cluster element (in our case, a student) summarizing the average characteristics of the real cluster elements. We can, then, study the answering strategies composing the C_k array and give sense to the average behaviour of the cluster elements.

The k-means algorithm finds a new point in the cluster spatial distribution but poses the problem of finding the components of the b_k arrays.

In order to find the C_k arrays components, we elaborated a methodology that consists in repeating the k-means procedure in reverse. As it is difficult to do this analytically, we used an iterative method, described as follows. We work with the elements of a given cluster and we find all the possible permutations of an array,

C_j , composed by a number of 1 equal to the number of questionnaire items (and all other components fixed to 0). A function f is defined as the sum of the differences between the real distances (between each centroid and its cluster elements) and the “hypothetic” distances between each C_j array (obtained by permutation) and the cluster elements:

$$f_j(D_i^j, D_i^{j'}) = \sum_{i=1}^{N_j} (D_i^j - D_i^{j'})^2$$

Going on with the iterations, we find the specific array c_j that makes f minimum, i.e. that is the closest array representation of the real centroid. This array is, therefore, assigned to the cluster centroid.

It is possible to see that the C_j arrays found by following for each cluster the iterative procedure described above have 1 values exactly in correspondence to the answering strategies most frequently given by the cluster elements. We start from the consideration that a centroid is defined as the geometric point that minimizes the sum of the distances between it and all the cluster elements. Minimizing this sum means maximizing the correlation coefficients between the cluster elements and the centroid (see the Gower metrics definition) and this happens when each centroid has the largest number of common strategies with all the elements part of its cluster.

We have dealt with the problem of a-priori choosing the initial positions of the centroids. We found that it can be solved by repeating the clustering procedure for several values of the initial conditions and selecting those that lead to the minimum values of the distances between each centroid and the elements part of its cluster. Particularly, we found that, in order to find steady values for these minima it may be necessary to repeat the procedures to find a centroid up to 100000 times (depending on the specific spatial distribution of the cluster elements), each one with different initial conditions.

3. An example about the Boltzmann factor

In this section we will discuss an example of application of the techniques discussed above to the analysis of an open-ended questionnaire.

3.1 Context and sample

The questionnaire was administered to 118 students of 9 classroom of Scientific Upper Secondary School (18 years old) called in Italy Liceo. This specific typology of students was chosen for the experimental phase taking into account their good motivation and their high level of Mathematics, Chemistry and Physics competence related to the number of attending Chemistry, Mathematics and Physics lessons and particularly to the physics contents studies by them in classroom.

The questionnaire requires students to clarify the physical meaning of the quantities involved in the given phenomenon (the evaporation of a water puddle at different temperatures), discuss the related explicative model(s), and propose other experimental situations that can be explained by using the same model(s). The focus is on systems for which a process is thermally activated by overcoming a well-defined potential barrier

E , and is therefore described by an equation containing the Boltzmann factor $e^{-E/kT}$, where T is the system temperature and k is the Boltzmann constant.

It is comprised of six-items focused on the ability to create explanation related to the physics context of the Boltzmann factor.

The questionnaire items are inspired by other questionnaires on the processes of modelling already used in previous research (Fazio et al. 2012; Lederman et al., 2002; Fazio & Spagnolo, 2008; Ferri, 2006). However, although the validity of these questionnaire items to study the ideas and perceptions of university students on the concept of model is already demonstrated by the previous research, we decided to again subject the questionnaire to a face-validation phase (Anastasi, 1988), in order to highlight residual possible problems in the questions, like unclear or ambiguous terminology. A group of 9 students from different classrooms (one for each classroom) were asked to answer the questions. Then a focus group was conducted with the students, in order to clarify the meaning of their answers and get to the final version of the questionnaire to be used with the research sample.

After the questionnaire was submitted to the 118 students of our sample, each researcher independently read the answers, and wrote down a list of typical answers that, in his/her opinion, the students actually gave to each questionnaire item. The two lists were, then, compared and contrasted in several meetings between the researchers, in order to get to a shared and unique list, reporting the 59 typical answers given by the students to the questionnaire items. The integrated reliability of the analysis was good. Discordances between researcher lists were typically found as a consequence of the different personal disposition of the researchers

to synthesize the student answers in a more or less restricted number of typologies. In a few cases discordances were due to different researcher interpretations of student statements.

The complete list of 59 typical answers given by students to the questionnaire items is reported in the Appendix.

Each researcher, then, coded the student answers using the previously described list, building a matrix like the one depicted in Table 1, where $n = 118$ and $m = 59$. Again, some meetings were spent in order to compare the different matrixes and to come to a shared one to use for the clustering calculations.

3.2 The results

All the clustering calculations have been performed by using custom software written in C language, using the k-means method. The graphical representations of clusters has been obtained by using the well known MATLAB (MATLAB, 2015) software.

Figure 1 shows the representation of this partition in a 2-dimensional graph, where the x and y axis simply report the values needed to place each sample element according with its mutual distance with respect to the other elements.

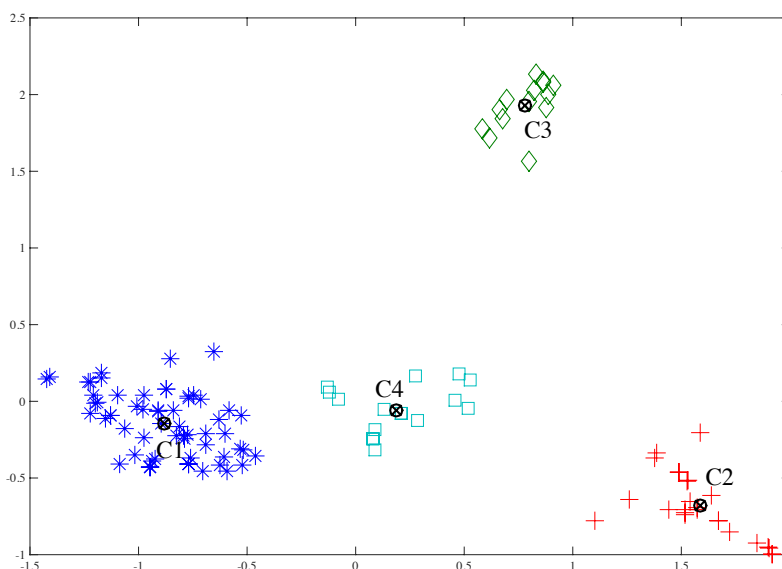

Figure 1. Partitioning of student data set. Four clusters are clearly depicted and the related centroids (C_1 , C_2 , C_3 , C_4) are shown.

The clusters found by means of the previous considerations are characterized by the related centroids, that, as discussed above, are the four points in the graph whose arrays C_k contain the answering strategies most frequently given by the elements of the related clusters. These strategies are defined as follows: C_1 : (1F, 2D, 3G, 4C, 5C, 6E), C_2 : (1B, 2B, 3A, 4A, 5B, 6A), C_3 : (1I, 2G, 3N, 4H, 5G, 6L), C_4 : (1D, 2C, 3B, 4A, 5C, 6B), where the codes in parenthesis refer to the answering strategies to the questionnaire items reported in the Appendix.

An analysis of these strategies allows us to characterize each centroid and so the related cluster. Particularly, the cluster identified by C_3 is the one composed by the students that exhibit the highest level answering strategies with respect to concepts dealt with the questionnaire. In fact, in average these students correctly recognize the characteristic discussed quantities of physic-chemical phenomena (2G) and to identify the relations between even if, in some cases only at a macroscopic level (4H). These students also well know how to find similarities between physical different systems (5G), providing an explanation of the working mechanism at a microscopic level. The student characterized by this profile show generalization ability (5G). The students part of clusters identified by centroids C_1 and C_4 can be defined as intermediate-level ones, even if at slightly different ways. Students in the C_1 cluster are the majority. These students are able to describe the relationships between the quantities in game, preferring the mathematical formulation (2D, 5C, 6E) in some cases only with a macroscopic approach. The explanations of the phenomenon are mostly generic (4C), in fact they never provide a working mechanism of the phenomenon. Some few correct generalizations in different contexts are found just on the basis of mathematical formula (6E).

The student characterized by the centroids C_4 are able to detecting the physical requested quantities using the mathematical formulas (5C) even if, in some cases, the description is referred to everyday life context

(4A). Also they fail to determine similarity between apparently different phenomena and therefore are not able to generalize in different contexts (6B).

The student characterized by the centroid C_2 represents the lowest level of involved students. These kinds of students have difficulty in defining and connect each other the physical quantities (2B). Their descriptions of phenomena is made on the basis of their knowledge of real life (4A) that are far from the scientific ones. They aren't able to find possible similarities between phenomena defined in different contexts (6A) and the few tentative of generalization is unfair (5A).

4. Conclusions

In this work we discussed the didactic problematic concerning the definition of a quantitative method aimed to analyse an open-ended questionnaire on a large sample of students. Among the different types of clustering techniques we chose to investigate the non-hierarchical one and in particular the k-means method. This technique, not well spread and known in the Education research field, has been described from its theoretical foundations.

We spent particular attention to the definition of the coefficient of correlation and to the type of metric to be used for using the potentiality of this method. The most important result of this work is the definition of a method by which to characterize in a simple way the students behaviour, dividing them into homogeneous groups with the characterization of the centroid obtained through, the k-means.

We moreover discussed an example of application relating to a questionnaire on a well-known epistemological physical context as the Boltzmann factor. The important of the use of a quantitative method in the Education field emerges from the obtained results. The used method permitted us to clearly highlight the student's behaviour and to classify them according to four groups (that emerged a-posteriori from the data), characterized by centroids and including students with a similar profiles.

Briefly, from the analysis emerged that only a small number of student shows significant ability of generalization. Only few of them are able to built a microscopic model for the description of physical phenomena. The majority of student instead simply provides descriptions more or less related to qualitative analysed phenomena. A limited number of students is bind to real life explanations. These results are in accordance with the literature related to the generalization and proving abilities of Upper secondary School students in Mathematics and Science (Fazio, C. and Spagnolo, F 2008; Heinze et al. 2009; Maaß K 2006; Mariotti, 2006).

The strength of this work is due to the possibility to characterize a large students sample through an automatic procedure without any a priori assumptions about their typical behaviour. In this sense our approach is different from the typical method quoted in literature (Brousseau, 1997). Our procedure also allows researcher to minimize possible errors of students behaviour characterization introduced by inevitable subjectivity.

References

- [1] Anastasi A 1988, Psychological testing. (Macmillan, New York, 1988), p. 144
- [2] Bao L and Redish E F 2006, Model analysis: Representing and assessing the dynamics of student learning, *Phys. Rev. ST Phys. Educ. Res.* 2, 010103.
- [3] Bao L Hogg K and Zollman D 2002, Model analysis of fine structures of student models: An example with Newton's third law, *Am. J. Phys.* 70, 766.
- [4] Brousseau G 1997, *Theory of didactical situations in mathematics 1970-1990*/by Brousseau; edited and translated by N. Balacheff, M. Cooper, R. Sutherland & V. Warfield.
- [5] Ding L and Beichner R 2009, Approaches to data analysis of multiple-choice questions, *Phys. Rev. ST Phys. Educ. Res.* 5, 020103
- [6] Fazio C and Spagnolo F 2008, Conceptions on modeling processes in Italian high school prospective mathematics and physics teachers, *S. Afr. J. Educ.* 28, 469.
- [7] Fazio C, Di Paola B. & Guastella I 2012, Prospective elementary teachers' perceptions of the processes of modeling: A case study, *Phys. Rev. ST Phys. Educ. Res.* 8, 010110.
- [8] Fazio C Battaglia OR & Di Paola B 2013, Investigating the quality of mental models deployed by undergraduate engineering students in creating explanations: the case of thermally activated phenomena, *Phys. Rev. ST Phys. Educ. Res.* 9, 020101.
- [9] Ferri RB 2006, Theoretical and empirical differentiations of phases in the modelling process. *ZDM*, 38(2), 86-95.

- [10] Gower JC 1966. Some Distance Properties of Latent Root and Vector Methods Used in Multivariate Analysis. *Biometrika Trust*, 53(3/4):325-338.
- [11] Heinze A & Reiss K 2009, Developing argumentation and proof competencies in the mathematics classroom *Teaching and learning proof across the grades: AK-16 Perspective*, 203191-203.
- [12] Lederman F, Abd-El-Khalick RL, Bell & Schwartz R 2002, Views of nature of science questionnaire: toward valid and meaningful assessment of learner's conceptions of nature of science. *J. Res. Sci. Teach.* 39 (6), 497-521
- [13] Leisch F 2006. A toolbox for K-centroids cluster analysis. *Computational Statistics & Data Analysis*, 51:526 – 544.
- [14] Maaß K 2006, What are modelling competencies?. *ZDM*, 38(2), 113-142.
- [15] MacQueen J 1967, Some methods for classification and analysis of multivariate observations. In: L.M. LeCam, J. Neyman (eds.): Proc. 5th Berkely Symp. Math. Statist. Probab. 1965/66. Univ. of California Press, Berkely, vol. I, 281- 297.
- [16] Mariotti MA 2006, Proof and proving in mathematics education. *Handbook of research on the psychology of mathematics education: Past, present and future*, 173-204.
- [17] MATLAB version 8.5 Natick, Massachusetts: The MathWorks Inc., 2015.
- [18] Sokal RR, Henry P, Sneath A 1963, Principles of Numerical Taxonomy, W. H. Freeman
- [19] Stewart J, Miller M, Audo C and Stewart G 2012. Using cluster analysis to identify patterns in students' responses to contextually different conceptual problems. *Physical Review St Physics Education Research*, 8, 020112.
- [20] Tumminello M, Micciché S, Dominguez LJ, Lamura G, Melchiorre MG, Barbagallo M & Mantegna RN 2011, Happy Aged People Are All Alike, While Every Unhappy Aged Person is Unhappy in Its Own. *PLoS ONE* 6(9): e23377, doi: 10.1371/journal.pone.0023377.
- [21] Tryon RC 1939, Cluster Analysis: Correlation Profile and Orthometric (factor) Analysis for the Isolation of Unities in Mind and Personality. Edwards Brothers.
- [22] Wittmann MC and Scherr RE 2002. Student epistemological mode constraining researcher access to student thinking: An example from an interview on charge flow. In K. C. Cummings, J. Marx, and S. Franklin (eds). *Physics Education Research Conference Proceedings 2002*. Boise (USA): PERC Publishing p. 43–46.

Affiliation and address information

Onofrio Rosario Battaglia
 Dipartimento di Fisica e Chimica
 Università degli Studi di Palermo, Italy
 email: onofriorosario.battaglia@unipa.it

Benedetto Di Paola
 Dipartimento di Matematica e Informatica
 Università degli Studi di Palermo, Italy
 email: benedetto.dipaola@unipa.it

Appendix

Questionnaire items and related answering strategies.

- 1) *A puddle dries more slowly at 20°C than at 40°C. Assuming all other conditions (except temperature) equal in the two cases, explain the phenomenon, pointing out what the fundamental quantities are for the description of the phenomenon and for the construction of an interpretative model of the phenomenon itself.*

1A The relevant quantities are not identified.

- 1B The relevant quantities are not identified, but a description/explanation based on common sense is given.
- 1C The relevant quantities are identified, but they are not used properly to give an explanation.
- 1D Only temperature is identified as relevant, but the phenomenon is not correctly described.
- 1E Only temperature is identified as relevant. It is used to give a rough description of the phenomenon.
- 1F The phenomenon is described by means of the macroscopic variables pressure and volume, but a microscopic model is not identified.
- 1G The phenomenon is described by means of the macroscopic variables temperature, energy and heat, but a microscopic model is not identified.
- 1H The phenomenon is described by means of a mathematical formula, but a microscopic model is not identified.
- 1I The phenomenon is not adequately described (by means of a mathematical formula or verbally), but a microscopic “functioning mechanism” is roughly presented in terms of “molecular collisions”.
- 1L The phenomenon is not adequately described (by means of a mathematical formula or verbally), but a microscopic “functioning mechanism” is presented in terms of energy exchange between molecules.
- 1M The phenomenon is verbally described and a microscopic “functioning mechanism” is roughly sketched.
- 1N The phenomenon is described by means of mathematical relations between macroscopic quantities and a microscopic “functioning mechanism” is found.

2) *In chemical kinetics it is well known that the rate of a reaction, u , between two reactants follows the Arrhenius law:*

$$u = Ae^{-\frac{E}{kT}}$$

Describe each listed quantity, clarifying its physical meaning and the relations with the other quantities.

- 2A The fundamental quantities are not described and/or only examples of its application to everyday-life phenomenology are given.
- 2B Some quantities are mentioned, but no description of the process is given.
- 2C The relevant quantities are found, but only a few are described in terms of their physical meaning.
- 2D The relevant quantities are found, but only described in terms of their mathematical meaning in the formula. No relation between them is identified.
- 2E The relevant quantities are found and correctly described in terms of their physical meaning. No relation between them is identified.
- 2F The relevant quantities are found and correctly described in terms of their physical meaning. Some relations between them are identified.
- 2G The relevant quantities are found and correctly described in terms of their physical meaning. The relations between them are correctly identified.

3) *What do you think the role of a catalyst is, in the development of a chemical reaction?*

- 3A A definition of catalyst is given, which does not conform to the scientifically correct one.
- 3B A definition of catalyst based on an analogy with the concept of enzyme is given. The analogy is recalled without providing additional reasoning.
- 3C The catalyst is described as a substance which speeds up a chemical reaction. No additional explanation is supplied.
- 3D The catalyst is described as a substance which shifts the chemical equilibrium towards the products. No additional explanation is supplied.

- 3E The catalyst is described as a substance which speeds up a chemical reaction. An explanation is given using common language.
- 3F The catalyst is presented as a substance which shifts the chemical equilibrium towards the products. An explanation is given using common language.
- 3G The catalyst is presented as a substance which speeds up a chemical reaction. The concept is generically described in terms of energy.
- 3H The catalyst is presented as a substance which shifts the chemical equilibrium towards the products. The concept is generically described in terms of energy.
- 3I The catalyst is presented as a substance which speeds up a chemical reaction. The concept is described by simply citing the energy gap concept, without any explanation.
- 3L The catalyst is presented as a substance which shifts the chemical equilibrium towards the products. The concept is described by simply citing the energy gap concept, without any explanation.
- 3M The role of a catalyst in a chemical reaction is discussed referring to the energy gap concept, but only in macroscopic terms.
- 3N The role of a catalyst in a chemical reaction is discussed taking into account the energy gap concept. The concept is explained considering a microscopic model regarding collisions between molecules.
- 3O The role of a catalyst in a chemical reaction is discussed taking into account the energy gap concept. The concept is explained considering a microscopic model which links the energy gap concept with the molecular energy.

4) *Can you give your own physics model of the Arrhenius law?*

- 4A Everyday-life concepts are mentioned, without any correct relation to the Arrhenius law.
- 4B Scientific concepts, such as energy, temperature or molecular thermal agitation, are mentioned, but they are not correctly related to the Arrhenius law.
- 4C Arrhenius law is described as a mathematical function of T or E. No explanation of the meaning of these quantities is given.
- 4D Arrhenius law is described as a mathematical function of both T and E. No explanation of the meaning of these quantities is given.
- 4E Arrhenius law is described as a function of both T and E and the meaning of these two quantities is outlined mainly in mathematical terms.
- 4F Arrhenius law is described as a function of both T and E. The physical meaning of these two quantities and/or of their ratio in the Arrhenius law is outlined.
- 4G Arrhenius law is described outlining the physical quantities involved. Collision theory is sometimes mentioned, but a clear reference to a microscopic model is not always present.
- 4H A generic explanation based on a microscopic model of collisions between molecules is given. The activation energy concept is outlined but its relation with kT is not clearly presented.
- 4I A quantitative explanation in terms of the "collision theory" is given. A correct microscopic model is presented and the role of the activation energy and of kT is clearly expressed.

5) *Can you think of other natural phenomena which can be explained by a similar model?*

- 5A A few phenomena not related to the model are mentioned. No explanation is given.
- 5B A few phenomena not related to the model are mentioned. An explanation is given using common language.
- 5C A few phenomena not related to the model are mentioned. An explanation is given using mathematical formulas.
- 5D Some phenomena related to the model are mentioned, and non-chemical phenomena are also taken into account, but a clear explanation is not given.
- 5E Some phenomena related to the model are mentioned, and non-chemical phenomena are also taken into account. An explanation is given using mathematical formulas.

- 5F Some phenomena related to the model are mentioned, and non-chemical phenomena are also taken into account. An explanation is given outlining a common microscopic model, but energy and temperature are not clearly interrelated.
- 5G Some phenomena related to the model are mentioned, and non-chemical phenomena are also taken into account. An explanation is given outlining a common microscopic model. The role of energy and temperature in the model is clearly discussed.

6) *Which similarities can be identified in the previous phenomena? Is it possible to find a common physical quantity which characterizes all the systems you discussed in the previous questions?*

- 6A No similarities are detected and questions 1) and 2) are identified as being related to a different context on the basis of everyday-life reasoning.
- 6B No similarities are detected and questions 1) and 2) are identified as being related to a different context. An explanation is given, mentioning physical quantities which are not really relevant to the correct explanation of the questions.
- 6C A few correct similarities are found, but physical quantities are given, which are not really relevant to the correct explanation of the questions.
- 6D Incorrect similarities are found on the basis of a mathematical formula.
- 6E A few correct similarities are found on the basis of a mathematical formula.
- 6F Correct similarities are found, but E and T are not always considered common to all phenomena.
- 6G Some correct similarities are found. E or T is considered to be characteristic of the various phenomena, but a clear justification is not given.
- 6H Some correct similarities are found. E or T is considered to be characteristic of the various phenomena, clearly explaining why.
- 6I Some correct similarities are found. E or T is considered to be characteristic of the various phenomena, but the relevance of their ratio in explaining the energy threshold processes is not clearly presented.
- 6L Some correct similarities are found. E or T is considered to be characteristic of the various phenomena. The activation energy role is correctly discussed in all the mentioned phenomena, but only in macroscopic terms.
- 6M Some correct similarities are found. E or T is considered to be characteristic of the various phenomena. The activation energy role is correctly discussed in all the mentioned phenomena, on the basis of a microscopic model.

An American Instructor in an Upper-Level Italian Physics Class

Gerald Feldman

*George Washington University, Washington, DC, USA
and University of Trento, Italy*

Abstract

In this paper, I report on my experience in teaching a 3rd-year undergraduate physics class at the University of Trento during the Spring 2014 semester. I address questions relating to the application of active-learning techniques, usage of English language in the classroom, and student reactions to an innovative style of pedagogy.

Keywords

Active learning, collaborative group learning, peer instruction, clickers, nuclear physics, English language.

1. Introduction

Interactive engagement strategies are becoming more and more common in physics classes in the United States. While this approach is utilized mostly in introductory classes, it is gaining favor in upper-level classes as well. For example, the University of Colorado group has been conducting an extensive research program on such methods in the advanced courses at their own institution [2,3,5,6,10,11]. In my experience at George Washington University, I have used such techniques (Peer Instruction [9], electronic “clickers”, active learning) for over 15 years, and in the past 6 years, we have been employing the SCALE-UP collaborative group-learning approach [4,13] in our introductory classes. When I had the opportunity to come to Italy in Spring 2014 and teach an upper-level class in nuclear experimental techniques, the pedagogical style that I would adopt became a pressing question. How would the Italian students respond to a more actively engaged environment in the classroom?

Before the class began, my initial impressions were that the physics classes in Italy were taught in a rather conventional style, using formal lectures with lessons written on the blackboard and with relatively little input from the students in the classroom. Colleagues at the University of Trento more or less confirmed that this was indeed the case, and that the students in the class would not be accustomed to taking such an active participatory role in the classroom activities. In addition, the class would be taught in English, which is not the norm for the undergraduate classes at Trento, and so the issue of language became an important factor to take into consideration. Since the class was offered as an elective for the 3rd-year undergraduate students, their participation was optional (*i.e.* they could drop the class if they did not like it), and so a balance had to be established between trying out some of these active-learning techniques in the classroom and “testing the tolerance” of the students who were mostly accustomed to a more passive classroom environment.

Overall, during the period of my visiting semester in Italy, I wanted to immerse myself in the pedagogical culture and explore the following research questions:

- Is there a predominant pedagogical style in Italian physics classes?
- What are the attitudes of the undergraduate students about science in general, and about doing science in particular?
- What are the reactions of the students towards an active-learning classroom? This can be broken down into 3 components: satisfaction, performance and perception.
 - ✓ Did they like the more interactive environment?
 - ✓ Did they participate fully in the activities performed during the class period?
 - ✓ Did they perceive any educational benefit from the higher level of engagement?
- Was the English language issue a major handicap in teaching the class?

In this paper, these questions are addressed within the context of the limited case study that was carried out over the period of my visit. I describe my experience in this upper-level Italian physics class and present the approach that was followed in introducing to the students some of the pedagogical innovations that have been developed in recent years. The assessment methods used to evaluate the performance of the students in the course are also explained. Finally, I present a retrospective summary of how this experiment fared, along

with feedback from the students themselves on how they perceived the active-learning experience in this class.

2. Course Description

The course in question was Experimental Techniques in Nuclear Physics, which was an elective course for 3rd-year Italian undergraduate students in physics at the University of Trento. The course comprised 48 academic hours, which was broken down into two 2-hr classes per week for a period of about 12 weeks. The course did not have a laboratory component. While the undergraduate courses (in years 1-3) are normally taught in Italian, in this case the course had to be taught in English, since the instructor did not speak Italian! However, since the master's courses (years 4-5) are all taught in English at the University of Trento, the students are generally prepared for a course in English at this point in their academic life.

The enrollment for the class was 9 students. In Trento, the 3rd-year cohort of students numbered about 50-60, and with six elective courses available to them, class sizes were generally in the range of 8-12 students for each elective. The course was delivered in a lecture format using PowerPoint slides, but with many active-engagement elements that are described below. The assessments in the course were based on a written mid-term exam (worth 35%) and a final exam consisting of both written and oral components (worth 30% and 35%, respectively).

Over the semester of 12 weeks, starting in mid-February and going until early June, we covered a series of topics that are outlined in the syllabus shown in Fig. 1. The first two weeks were used to review basic material that is generally presented in a Modern Physics course involving very basic quantum physics. The next five weeks were dedicated to various types of detectors, including gaseous detectors, solid-state detectors and scintillators. With that critical background in hand, the remainder of the course explored various aspects of nuclear physics experiments, including accelerators, production of particle and photon beams, electronics, and data analysis. Three textbooks [7,8,12] were used to provide the reference material on which the lectures were based. In the final week of the course, we also had a full-day field trip to the INFN nuclear laboratory in Legnaro (near Padova), which gave the students first-hand exposure to the activities at such a national laboratory and the daily life of nuclear physics researchers.

<u>Week</u>	<u>Topics</u>
1	Basic Nuclear Processes and Radiation
2	Interaction of Radiation in Matter
3	General Characteristics of Detectors
4	Ionization Detectors
5	Scintillation Detectors
6	Semiconductor Detectors
7	Neutron Detection Techniques
8	Basic Features of Nuclear Experiments
9	Particle Beams and Photon Beams
10	Nuclear Electronics and Signal Processing
11	Data Analysis
12	Nuclear Laboratories Around the World

Figure 1. The course syllabus, listing the topics in chronological order.

The lectures were delivered in a rather informal style, more reminiscent of a “running conversation” with the students. There was much back-and-forth discussion, with input being continually sought from the students as things moved along. Beyond these close interactions with the instructor, there were many opportunities for group discussions among the students themselves. This could be in the case of a numerical problem that they had to solve together, spending about 15 minutes to do so, or it could be in the case of Peer Instruction [9], in which they had to respond to conceptual questions using an electronic response system (“clickers”). Two examples of the latter are shown below in Fig. 2. We used *Turning Point* keypads [14] for the Peer Instruction questions. The small hand-held keypads (shown in the left panel of Fig. 2) were provided to the students by the instructor – keypads were distributed at the beginning of the class period and collected at the end. Each question would entail about 2-3 minutes of discussion among the students, followed by the acquisition of their electronic responses, and then the resulting histogram would be shown, promoting further discussion. Ultimately, the group would agree on the right answer, and after a satisfactory explanation was provided (by the students, hopefully), we would move on to the subsequent material.

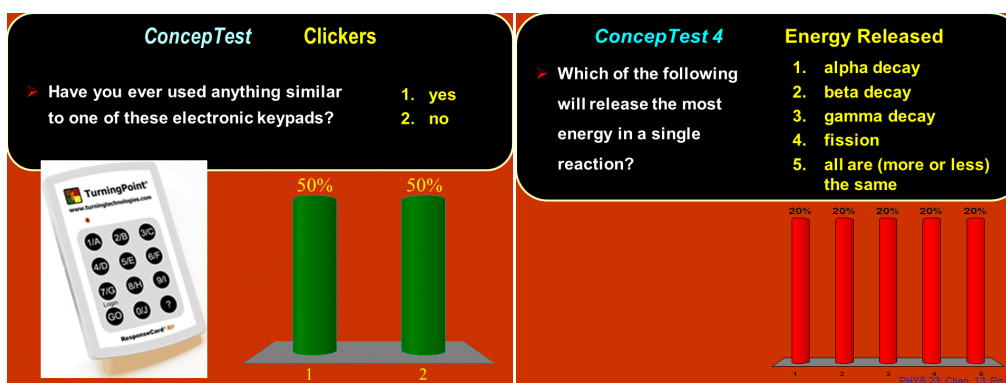

Figure 2. Examples of “clicker” questions using the *Turning Point* keypads.

3. Results

The first research question related to the typical or common pedagogical style for a physics class in Italy. During the course of the semester, I had the opportunity to observe the classes of two different instructors, for a total of about 10 class sessions. One of these was a 2nd-year class and the other was a 3rd-year class, both of which were required classes for those particular cohorts. Based on my observations, I concluded that these classes were delivered in a very standard and conventional lecture format, where the instructor talks for about an hour at a time and the students sit passively and listen, while taking notes. Very few questions (if any) are posed by the students during the lecture period. Moreover, leading questions posed by the instructor to the students were very rarely answered by the students. In most cases, the instructor was forced to answer his own question, in order to keep the class moving along. Overall, there was very little interaction between the instructor and the students.

3.1 Student Attitudes about Science

Another question was related to the attitudes of the students about science. Attitudes held by students evolve over time as they develop in their respective fields. Initially, student behavior may reflect a more “novice” attitude, but with growth and maturity, this becomes more “expert” as time goes on. One of the newer surveys that has been developed to gauge this “expert-novice” spectrum of attitudes is the Colorado Learning Attitudes about Science Survey (CLASS) [1]. This survey consists of 42 questions that are grouped into 8 general categories:

- Sense-making/effort
- Personal interest
- Real-world connections
- Conceptual understanding
- Applied conceptual understanding
- Problem solving (general)
- Problem-solving sophistication
- Problem-solving confidence

Based on the students’ responses to these questions, including numerous questions that probe the same category along different dimensions, an evaluation of the degree to which the student demonstrates “expert”

or “novice” behavior is determined. For the 9 students in my class, the results are shown in Fig. 3 below. In all categories, the expert column far exceeds the novice column, and four of the categories are over 70% in the expert column. In particular, the very important categories of Sense-making/Effort (86%) and Personal Interest (78%) scored the highest in the expert column. Almost all of the novice ratings are below 10%, with only one exception (which is only 16%).

Category	Expert	Novice
Sense-making / Effort	86%	3%
Personal Interest	78%	4%
Real-World Connections	69%	6%
Conceptual Understanding	74%	9%
Applied Conceptual Understanding	57%	16%
Problem Solving (general)	74%	6%
Problem-Solving Sophistication	61%	4%
Problem-Solving Confidence	67%	8%

Figure 3. Results of the CLASS science attitudes survey.

3.2 Student Language Ability

Another research question was related to the usage of English language in the class, and in retrospect, this proved not really to be an issue at all. The students’ English language abilities were good, although it is worth noting that not all of the students felt completely comfortable speaking up in class. While the language seemed not to be a hindrance in class, it may have contributed to slow progress on the written exams. In general, the students needed extra time to formulate complete answers on these exams, and so an exam with 8 problems that was intended to last for 2 hours ended up continuing on for 3 hours (or in the case of the final exam, for 4 hours). However, I found that the oral component of the final exam was actually an excellent test of the language skills of the students. Their performance on this part of the final exam was really quite impressive, their knowledge of the material was extensive, and their verbal explanations were clear and always understandable.

3.3 Active Learning in the Classroom

The biggest question of the entire semester, however, was the reaction of the students to the many active-learning elements that were used in this particular class. The expectation was that this would be very different from their usual experience in other classes, and so it was not obvious at the outset how these activities would be viewed or accepted by the students. What I found was that the students were very excited about the active-engagement techniques (in particular, the use of clickers) and had no hesitation whatsoever about participating in classroom discussions. Questions posed in class were widely argued and debated by the students, and clarification questions originating from the students themselves emerged quite spontaneously. The clickers were used primarily in the first half of the semester, and the lack of clicker usage in the second half was noticed by the students, who wanted to continue using them more frequently. In addition, the organized class field trip to the INFN nuclear laboratory in Legnaro was itself a highly engaging active-learning experience, and moreover, it was specifically cited by several students as one of the highlights of the entire course.

Before examining student feedback in more depth, it is worthwhile to consider a comparison between the Italian students and typical American students. While there were many similarities between the two groups (perhaps not a surprise), there were also some interesting differences. The Italian students were equally active in the classroom, despite not having an appreciable level of such experience in the past. They were equally willing to interact with the instructor on a rather informal level, even though their prior experience had been in a much more formal relationship with their other instructors. The Italian students were very

willing to accept new conditions, and they demonstrated a higher level of preparation and background in the basic physics fundamentals than their American counterparts. In addition, as a purely anecdotal remark, the Italian students did not complain about things in the class, which is (unfortunately) a common behavior pattern among American students!

3.4 Student Questionnaire

As a means of gauging the reactions of the students to the innovative elements of the course, an online survey was given in the last week of the semester. All 9 students responded to the survey, and an overview of their responses is given below. First of all, they were asked to rate the level of interactivity for this course, and also for their other courses. The answers were based on a Likert scale in the range 1-10, where 10 indicated the highest interactivity. The results for this question are displayed in Fig. 4.

The average level of interactivity was 8.6 for the present course, as opposed to 4.2 for the other courses. It is also clear from the bargraph that the responses for a given case were more or less consistent with each other – that is, they were generally clustered together and there was not a great deal of variability in the responses for a given case. As shown in Fig. 4, the responses for the present course ranged from 7 to 10, whereas the responses for the other courses were in the range of 3 to 6.

The students were also asked how much they think they learned in the course. The responses were also based on a Likert scale in the range 1-5, where 5 indicated the highest knowledge gain. The responses to this question are shown below in Fig. 5. As can be seen in the figure, the majority felt that they had learned a lot in the course, with all of the responses being at the level of 4 or 5 on the Likert scale.

Finally, several qualitative questions were posed to the students, with open-ended responses. These are listed below, and a summary of the student comments is given. Several aspects were covered in these questions, such as: (1) differences between this course and the other courses in the students' curriculum, (2) reactions to the use of clickers in the classroom, (3) most useful features of the course, (4) things that should be changed in the course, and (5) any additional comments that the students would like to make. The students' responses are faithfully reproduced, directly as written by them, with only minor corrections for some spelling mistakes. Other than that, the words are the students' own words.

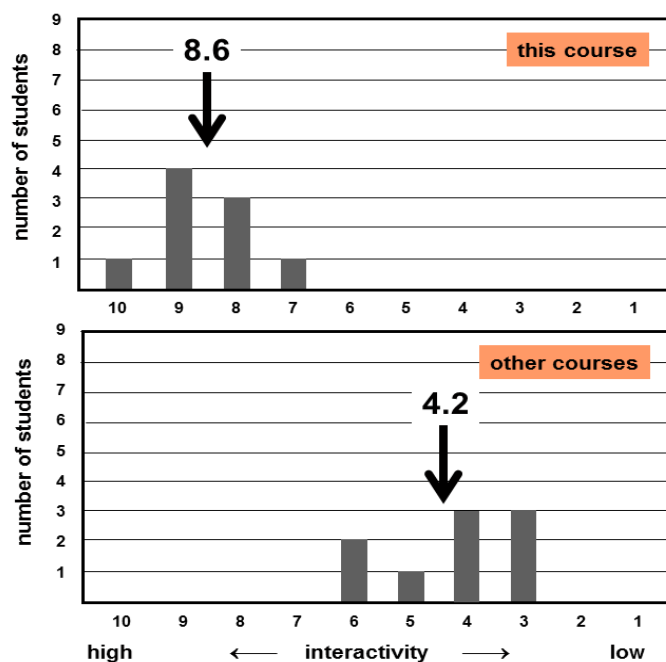

Figure 4. Student feedback on levels of interactivity in the present course (top panel) and their other courses (bottom panel). The average for each case is indicated by the arrow.

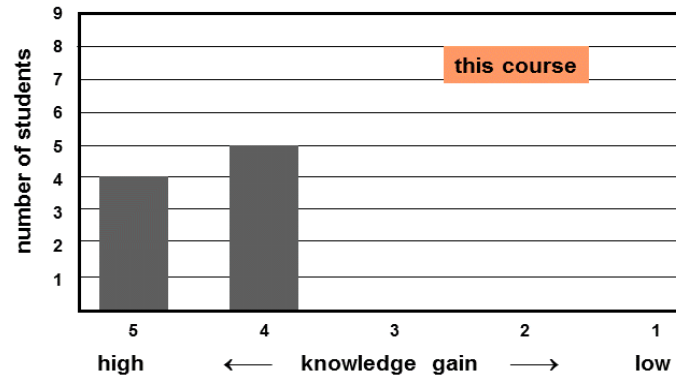

Figure 5. Student feedback on perception of knowledge gain in the present course.

(1) How did this course compare to your other courses in Trento? In what way(s) did you find it to be different?

- In this course there was much more interaction and discussion than any other attended courses.
- I've found this course very different from the other courses in Trento. I've really appreciated the way in which the professor interacted with us asking quick questions that helped us to better understand the concepts.
- It was less formal than the other courses and the lessons were lighter to follow. Especially at the start when we have to answer simple problems with "clickers", it was a nice way for having a small break!
- From all other courses it's different because of the high interactivity between the students and professor which makes it easy to follow and highly explicative.

(2) Were the electronic keypads ("clickers") used in the first half of the semester useful to you? Did they help enhance your understanding of the course material?

- Yes, they were useful as they allow to test immediately our understanding of the concepts.
- Yes, it was really useful both for introducing the argument and for understanding if we have really understood the concept of the various lessons.
- They were useful: the need to give a fast answer to a question makes you realize if you really understood a concept.
- Yes of course. I like it, because in other classes, the teacher asked us a question, but only one or two persons answered, in this way all the people have to answer.
- They were really useful because they made the class discuss on the question right after a topic had been explained by the teacher.

(3) What aspect of the course was the MOST useful to you?

- Slide used was a nice way to keep the attention. Few people use it in Trento but they are good because if you lose yourself in some thinking when you get back to the lesson you can easily recover what was lost.
- The way things are explained! Everything is explained clearly and in a simple manner in class and then is well integrated by the textbooks.
- The English language.
- The talking, or, more generally, the interaction. During the semester I realised that I was more prepared on this course rather than the others, with less studying.
- The use of English to improve this language, but also the examples in every argument.
- I think the experimental argument, because in Trento there aren't courses like this. If you want to do experimental physics, you have to know this stuff!

(4) If you could change ONE thing in this course, what would it be?

- So I think it could be useful to have a little amount of laboratory hours, just something like three or four hours, for touch with hands some easy detector and detection circuit.
- I don't know how but I want to see an experiment from the beginning to the end (maybe little stupid experiment).

- Exam modes.
- Number of exercises in the written exam.
- Maybe more exercises in the second part of the course (the one with particle beams and accelerators).
- Also use the electronic keypads in the second part!
- I would not change anything!

(5) Any other comments?

- The trip in Legnaro was very interesting and stimulating! It was a great opportunity for us to visit a laboratory. The teacher didn't correct our English, it was a good thing for communication especially at the beginning of the course.
- More keypads! More keypads for everyone! Ok, apart from jokes, this course was a really nice experience, I'm glad I took it.
- I like this course and I will explore these topics again!
- We should definitely have a pizza in July.

4. Summary

As an English-speaking American instructor, I spent the Spring 2014 semester teaching a course (Experimental Techniques in Nuclear Physics) to 3rd-year Italian undergraduate physics students at the University of Trento. The course employed an active-learning approach in which the students were fully engaged in the classroom activities and were enthusiastic participants throughout. This was accomplished through frequent questioning, generally achieved by using an electronic student response system (“clickers”) and also by posing numerical problems that the students would solve collaboratively in class.

The end result of this pedagogical experience proved to be highly favorable, as perceived both by the students and the instructor. The overall student performance in the course was excellent, and student engagement seemed to be maintained at a high level, from the perspective of the instructor. Student reactions were explored in an end-of-semester survey, and the self-reported responses in that survey were quite positive. The level of interactivity in the course was judged to be extensive, and the student perception of knowledge gain was also considerable.

While the study reported in this paper is admittedly limited, it is my opinion that the disposition of the Italian students was quite appropriate for an active-learning environment and that they would benefit tremendously from such an approach in the introductory classes. Working through the physics material together in class and solving numerical and conceptual problems in a collaborative manner could yield sizable learning gains. It would be very interesting to try a similar experiment in one of these lower-level classes, with a larger student population, to see how those students would respond to an active-learning approach in that particular case.

Acknowledgements

I would like to thank the U.S.-Italy Fulbright Commission for the Fulbright Fellowship that made my semester in Italy possible. I am also grateful to the Department of Physics at the University of Trento for additional support and for their warm hospitality. Finally, I would like to express my deepest gratitude to G. Orlandini and W. Leidemann for their friendship, insights, and experience, all of which greatly enhanced my visit to their institution and their city.

References

- [1] Adams, W.K., Perkins, K.K., Podolefsky, N., Dubson, M., Finkelstein, N.D. and Wieman, C.E. (2006). A new instrument for measuring student beliefs about physics and learning physics: the Colorado Learning Attitudes about Science Survey, *Phys. Rev. Special Topics — Phys. Educ. Res.* **2**, 010101.
- [2] Baily, C. and Finkelstein, N.D. (2010). Teaching and Understanding of Quantum Interpretations in Modern Physics Courses, *Phys. Rev. Special Topics — Phys. Educ. Res.* **6**, 010101.
- [3] Baily, C. Dubson, M. and Pollock, S.J. (2013). Developing Tutorials for Advanced Physics Students: Processes and Lessons Learned, *Proceedings of the 2013 Physics Education Research Conference (PERC)*, AIP Press.

- [4] Beichner, R., Saul, J.M., Abbott, D.S., Morse, J., Deardorff, D., Allain, R.J., Bonham, S.W., Dancy, M. and Risley, J. (2007). Student-Centered Activities for Large Enrollment Undergraduate Programs (SCALE-UP) Project, In Redish, E.F. and Cooney, P.J. (Ed.), *Research-Based Reform of University Physics*. College Park, MD: AAPT.
- [5] Chasteen, S.V., Pollock, S.J., Pepper, R.E. and Perkins, K.K. (2012). Thinking like a physicist: A multi-semester study of junior-level electricity and magnetism, *Am. J. Phys.* **80**, 923.
- [6] Chasteen, S.V., Pollock, S.J., Pepper, R.E. and Perkins, K.K. (2012). Transforming the junior level: Outcomes from instruction and research in E&M, *Phys. Rev. Special Topics — Phys. Educ. Res.* **8**, 020107.
- [7] Knoll, Glenn F. (2010). *Radiation Detection and Measurement* (4th edition). Hoboken, NJ: John Wiley & Sons, Inc.
- [8] Leo, William R. (1994). *Techniques for Nuclear and Particle Physics Experiments: A How-to Approach* (2nd edition). New York, NY: Springer-Verlag.
- [9] Mazur, Eric (1997). *Peer Instruction: A User's Manual*. Upper Saddle River, NJ: Prentice-Hall, Inc.
- [10] Pollock, S.J., Chasteen, S.V., Dubson, M. and Perkins, K.K. (2010). The Use of Concept Tests and Peer Instruction in Upper-Division Physics, *Proceedings of the 2010 Physics Education Research Conference (PERC)*, AIP Press.
- [11] Pollock, S.J., Pepper, R.E. and Marino, A.D. (2011). Issues and Progress in Transforming a Middle-Division Classical Mechanics/Math Methods Course, *Proceedings of the 2011 Physics Education Research Conference (PERC)*, AIP Press.
- [12] Tavernier, Stefaan (2010). *Experimental Techniques in Nuclear and Particle Physics*. Berlin: Springer-Verlag.
- [13] The SCALE-UP web site is located at: <http://www.ncsu.edu/PER/scaleup.html>
- [14] The *Turning Point* web site is located at: <http://www.turningtechnologies.com>

Affiliation and address information

Gerald Feldman
Department of Physics
George Washington University
Washington, DC 20052, USA
e-mail: feldman@gwu.edu

Teacher Change in Implementing a Research Developed Representation Construction Pedagogy

Peter Hubber, Gail Chittleborough

Faculty of Arts & Education, Deakin University, Victoria, Australia

Abstract

The Representations in Learning Science (RiLS) project developed a representation construction approach to teaching and learning in science, which has successfully demonstrated enhanced student learning through sustained engagement with ideas, and enhancement of teachers' pedagogical knowledge and understandings of how knowledge in science is developed and communicated. The current Constructing Representations in Science Pedagogy (CRISP) project aims at wider scale implementation of the representation construction approach. This paper explores a range of issues that confronted four Year 8 teachers in implementing this research-developed approach, such as: preparedness of the teacher in terms of epistemological positioning and positioning as a learner, significant support for planning and modelling by the university expert, and a team ethos where teachers share ideas and plan jointly. The Year 8 teachers implemented a representation construction approach to the teaching of the topic of astronomy. The Interconnected Model of Teacher Growth (IMTG) (Clarke & Hollingsworth, 2002) was used to analyse the teachers' experience in planning and delivering the teaching sequence. This model was found to be flexible in identifying the experiences of teachers in different situations and useful in identifying issues for implementation of a research developed pedagogy.

Keywords

Representation, Pedagogy, Teacher Change, Directed-inquiry.

1. Introduction

There is a growing consensus that quality learning must involve richer and more sustained reasoning and engagement with the mediating tools of the discipline in ways that entail the acquisition of a subject-specific set of purpose-designed literacies (Lemke, 2004). Students use the multi-modal representational tools of science to generate, coordinate and critique evidence (Ford & Forman, 2006), involving models and model-based reasoning (Lehrer & Schauble, 2006). A recent Australian Research Council (ARC) funded project, Representations in Learning Science (RiLS), successfully developed a theoretically sophisticated but practical, representation construction approach to teaching and learning that links student learning and engagement with the epistemic (knowledge production) practices of science (Tytler, Hubber, Prain & Waldrup, 2013). This approach involves challenging students to generate and negotiate the representations (text, graphs, models, diagrams) that constitute the discursive practices of science, rather than focusing on the text-based, definitional versions of concepts. The representation construction approach is based on sequences of representational challenges which involve students constructing representations to actively explore and make claims about phenomena. It thus represents a more active view of knowledge than traditional structural approaches and encourages visual as well as the traditional text-based literacies. RiLS has successfully demonstrated enhanced outcomes for students, in terms of sustained engagement with ideas, and quality learning, and for teachers' enhanced pedagogical knowledge and understanding of how knowledge in science is developed and communicated (Hubber, 2013, 2010; Hubber, Tytler, & Haslam, 2010).

The set of principles (Tytler et al., 2003, p. 34) developed by the RiLS project that underpin the representation construction approach are broadly described as:

1. **Teaching sequences are based on sequences of representational challenges:** Students construct representations to actively explore and make claims about phenomena

2. **Representations are explicitly discussed:** The teacher plays multiple roles, scaffolding the discussion to critique and support student representation construction in a shared classroom process. Students build their meta-representational competency (diSessa, 2004) through these discussions.
3. **Meaningful learning involves representational/perceptual mapping:** Students experience strong perceptual/experiential contexts, encouraging constant two-way mapping/reasoning between observable features of objects, potential inferences, and representations.
4. **Formative and summative assessment is ongoing:** Students and teachers are involved in a continuous, embedded process of assessing the adequacy, and their coordination, in explanatory accounts.

These principles formed the basis of the current Constructing Representations in Science Pedagogy (CRISP) project which aims at wider scale implementation of the representation construction approach. In introducing the approach to new teachers the CRISP researchers aim to identify key enablers, and blockers, that facilitate quality teacher learning and adaptation of the representation construction approach. This paper explores the issues that faced four Year 8 teachers from a Melbourne metropolitan private school who were initially introduced to the representational construction approach and then implemented the approach in a four-week teaching sequence in the topic of astronomy.

The professional growth of a teacher that leads to a change of practice should be considered as a result of a complex process (Clarke & Hollingsworth, 2002). To explicate the underlying processes that mediate teacher change Clarke and Hollingsworth (2002) developed the Interconnected Model of Professional Growth (IMPG) (see Fig. 1). The IMPG identifies four domains in which change can take place:

- Personal domain - a teacher's knowledge, skills, attitudes and beliefs;
- Domain of practice - all forms of professional experimentation;
- Domain of consequence - outcomes of new practices for the teachers themselves and their students; and
- External domain - sources of information and/or stimuli and support to develop new practices.

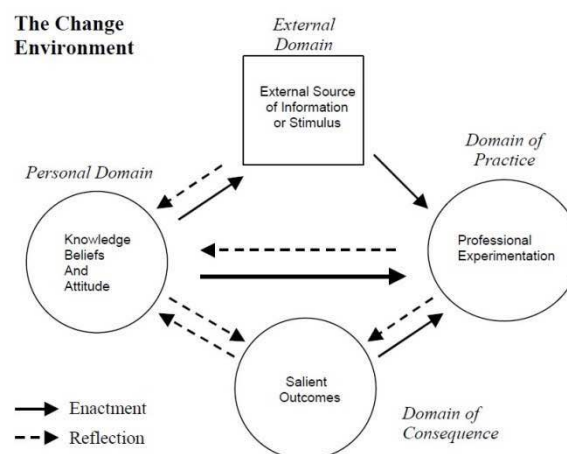

Figure 1. The Interconnected Model of Professional Growth

The first three listed domains form a part of the teacher's professional life whilst the fourth, external, domain is outside the professional day-to-day world of the teacher. Change may occur in any domain, and is mediated through the processes of enactment and reflection. According to Clarke and Hollingsworth (2002), the processes of enactment and reflection can be described in terms of paths connecting the various domains, which mirror the learning processes taking place (see Fig. 1). The IMPG is used in this study as a lens for identifying change in the Year 8 teachers in addition to exploring the issues they faced in implementing a research developed pedagogy, the representation construction approach.

2. Background: change environment and external domain

Any change in the professional growth represented in the IMPG occurs within the constraints and affordances of the change environment. Salsa¹ College is an all-boys Catholic secondary school with student enrolment around 950. There were four teachers (Alice, Suzie, Kate and Jaz) who taught five Year 8 classes (28-30 students) the topic of astronomy. One class was special entry (high academic achievement) taught by Alice; two classes were taught by Kate. All teachers were quite experienced, Suzie and Jaz had taught at Salsa College for several years, Alice was in her first year at Salsa College and Kate was in her first Term. The topic of astronomy dealt with explanations associated with such phenomena as day/night cycle, phases of the moon, seasons, gravity and eclipses. The intention was to address the new Australian Curriculum: Science (ACARA 2010) and so the content of this topic addressed this curriculum.

The external domain consisted of curriculum resources and professional development (PD) delivered to the teachers in various forms by the CRISP research team. Each of the teachers was given curriculum resources developed by the RiLS project. This resource consisted of pre- and post-tests (with previous performance data), written descriptions and teacher reflections of various activities that illustrated the representational approach, examples of students work from the RiLS project, and digital resources in the form of PowerPoint presentations with embedded interactive simulations and video.

In addition to these resources Alice had prior knowledge of the representational construction approach through participation in a 3-day Switched on Secondary Science Professional Learning (SOSSPL) program the previous year whilst teaching in a Victorian Government school. The SOSSPL program, a Victorian Department of Education initiative, was developed and delivered by RiLS/CRISP research staff and informed by the representation construction pedagogy. Suzie and Jaz had undertaken a 2-hour after-school workshop delivered by the CRISP researchers to the science staff at Salsa College. In the workshop importance was placed in modelling the representation construction approach by the CRISP researchers.

The support given to the teachers also consisted of weekly meetings during the teaching sequence where the CRISP researchers and teachers had reflective discussions as to the previous week's teaching in addition to planning the future week's teaching. A few months following the teaching sequence the CRISP researchers and teachers had a whole day workshop review of discussions and presentations. The presentations involved examining students' artefacts that included their responses to a variety of representational challenges and reflecting on segments of the teaching sequence shown in the classroom video that was taken of one lesson taught by each of Jaz, Alice and Kate. The workshop review also included discussions about the teachers' perceptions of the representation construction pedagogy in relation to their practice.

3. Methods

As mentioned in the background there were four Year 8 teachers who taught a four week teaching sequence in astronomy to 5 classes of boys (class size 28-30 students). In determining the issues that faced the four Year 8 teachers in implementing the representation construction approach the following data collection instruments were used:

- Pre- and post-tests;
- Classroom video of one lesson of three of the teachers – the lesson was chosen by the teacher;
- Recorded, and transcribed, teacher and selected student interviews following the teaching sequence;
- Student artefacts, in particular, their project books which contained a record of their responses to many of the representational challenges as part of the representation construction approach;
- Recorded, and transcribed, conversations among the CRISP researchers and teachers every week of the teaching sequence; and
- Whole day review with CRISP researchers and teachers which involved discussions of the student work and selected videos of the teachers' practice. The review was recorded and transcribed.

4. Findings

Whilst the teachers were given curriculum and pedagogical advice by the CRISP researchers they had final say as to what resources they would use and the manner in which they were to interpret and implement the representation construction approach. It was found that the teachers enacted many of elements of the CRISP external domain in their teaching sequence. It was also found that the teachers modified some of the resource material in addition to introducing others as they trialled and reflected on the application of the

¹ Pseudonyms have been used for the school as well as the teachers mentioned in this paper

representation construction approach in their teaching. The main findings are outlined in the following themes:

- Student learning.
- Pre-testing and alternative conceptions.
- Student record keeping.
- Summative assessment.
- Teaching for meta-representational competence.
- Teacher collaboration.
- Representation construction approach as inquiry.

4.1 Student Learning

The teachers perceived the students' learning gains as measured by their performance in multiple choice questions on the pre/post-tests as a significant salient outcome as the gains were higher than those obtained by a study undertaken by Kalkan and Kioglu (2007). This study involved 100 pre-service primary and secondary education teachers who participated in a semester length course in astronomy. A measure of comparison of pre- and post-test results is the normalized gain index, $\langle g \rangle$, the ratio of the actual average student gain to the maximum possible average gain: $\langle g \rangle = (\text{post}\% - \text{pre}\%) / (100 - \text{pre}\%)$, reported by Zeilik, Schau and Mattern (1999). Gain index values can range from 0 (no gain achieved) to 1 (all possible gain achieved). The mean gain reported by Kalkan & Kiroglu (2007, p. 17) was described as a "respectable 0.3". In contrast the mean gain for this study was significantly higher at 0.52.

4.2 Pre-testing and alternative conceptions

The pre-test was developed by the CRISP researchers and whilst the administration of pre-tests was not common practice at Salsa College the teachers agreed to implement it. The teachers initially viewed the pre-test as part of the research rather than integral to the teaching sequence. However, the view by all teachers on the use of a pre-test was positive: "Yeah, the pre-tests are good, and the way we used them was good too... I think a pre-test is a good idea (Suzy)". Kate added, "It just should be teaching practice; it should just be what we do (Kate)". The prevalence of alternative conceptions was surprising for Jaz who commented, "I didn't realize. I just thought once kids learn things that they keep a hold of it, but they don't" so a pre-test that exposes such views was "really helpful (Jaz)".

The teachers used the information gained from the pre-tests in their teaching as the illustrated by the following comments:

So I would say that, in that question [taken from the pre-test], what did we think and I'd get them to talk about it. And then at the end of the lesson, we'd say okay, so if we saw that question again, how would we be changing our answer to be more representative? ...we weren't pretending like they had this blank slate and they'd never seen astronomy before. They already had ideas, that we kind of – half the battle was challenging them, more so than teaching them new content (Alice).

I did deal with the topics that they had the most trouble with (Jaz).

In relation to the theme of pre-testing and misconceptions there of evidence of a growth network for Jaz which is illustrated in the IMTG diagram in Figure 2. In the first instance the pre-test was enacted as part of the research and not, in the minds of the teachers, as part of their professional experimentation. The salient outcome for Jaz was the realisation of the prevalence of misconceptions. She reflected on these and the need to address them in the teaching sequence which she enacted. A further salient outcome of significant learning gains by her students led her to a belief of the need to provide pre-tests as part of her

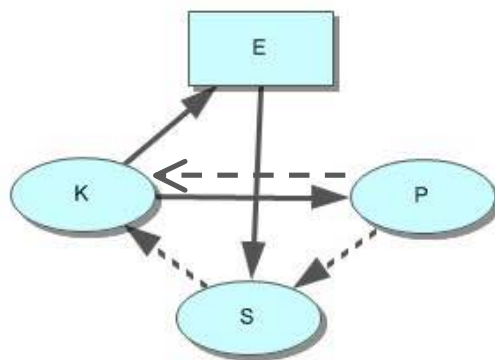

Figure 2. Growth network for Jaz

teaching practice and to seek out pre-tests from the external domain. This change was reflected in the following comments made by Jaz 12 months after the teaching of the astronomy topic:

[The] pre-test is very powerful. We have a booklet of pre-tests [now available to us] (Jaz).

...and the misconceptions; we knew where the majority of the class were thinking so you could direct your teaching to that...it highlighted for me the numbers in the class who don't get it, don't get a concept (Jaz).

4.3 Student record keeping

The workbooks used by the students were treated more like learning journals. They were project books that were larger than A4 in size and were formatted so that when opened the left hand page was lined and the right hand page was blank. The use of the project books was new to the students who previously used fully lined A4 sized workbooks.

The project books facilitated the use of drawings in recording what they learned (see Fig. 3 for some examples). Drawings were often used in addressing the representational challenges (see Fig. 4 for some examples). The blank page encouraged visual forms of representations. The visual representations provided the teachers with ready insight into students' thinking.

Immediately by looking at their representations, I know, okay those boys have got it and those boys are on the right track but those haven't fully kind of understood (Alice).

But the books just having the blank page, I think sometimes, it's just all text that we kind of forget how much the use of those representations and diagrams can really help in science, so it was a good reminder (Alice).

The students were more willing to use their journals to reflect on their learning

...they seemed more willing to go back over their work and look back at their past stuff as well...And I don't think they do it very well if it's just written stuff and they had a sense of ownership over it which was good (Kate).

They loved their project books. Like ridiculously... it was like this little diary of all the work that they'd done. It was different from what they had been doing (Alice).

What worked well? Perhaps me going back all the time revising and going back to their journal and having them look... They're quite taken with it (Jaz).

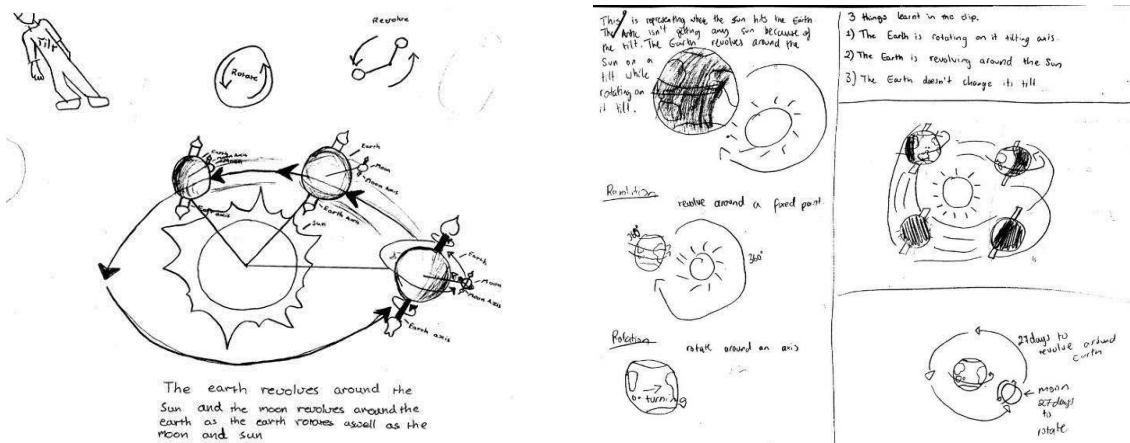

Figure 3. Examples of students' entries into their learning journals

The entries the students' made in their learning journals were seen by the teachers as a vehicle for discussion.

And I think ...that while they're doing their representations you can have conversations with them and be active with them but it's not such a threat, it's not give me the correct response, it's more about why have you done it that way (Alice).

I found that the discussions were a lot more sophisticated that they were having around the topics than usually with the textbook (Alice).

Representational Challenge: Represent in a drawing the height of the midday sun in winter from Melbourne

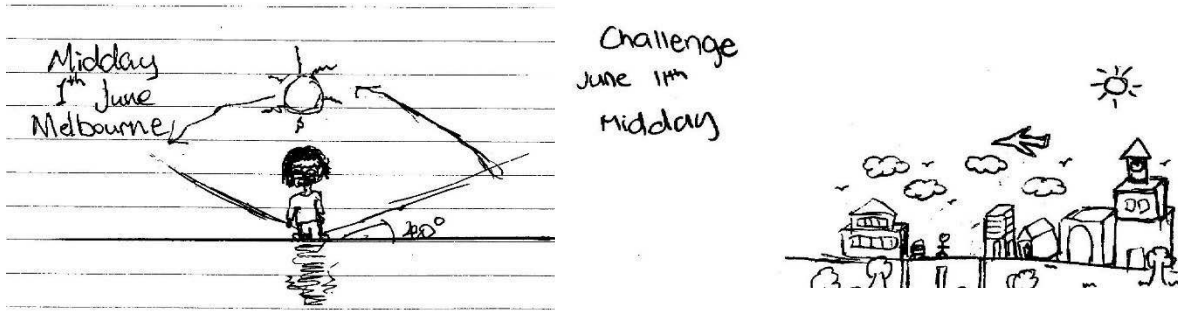

Representational Challenge: Why when we were watching the opening ceremony for the Olympics was it night in London, but morning here in Melbourne?

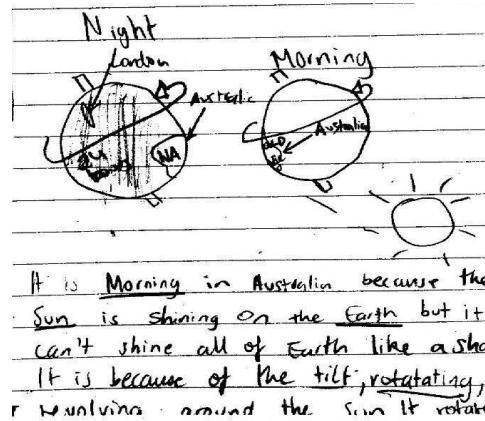

It is morning in Australia because the Sun is shining on the Earth but it can't shine all of Earth like a shadow. It is because of the tilt; rotating, revolving around the Sun it rotate

Figure 4. Examples of students' responses to two representational challenges

In relation to the theme of student record keeping there of evidence of a growth network for Alice which is illustrated in the IMTG diagram in Figure 5.

The project books were introduced into the teaching sequence and were reflected on and then used as learning journals. A key salient outcome was that the journals became a formative assessment tool for the teacher and a tool for deeper reflection for the students.

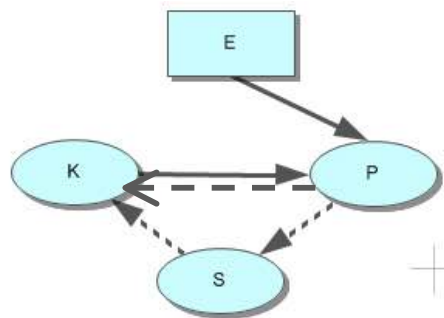

Figure 5. Growth network for Alice

4.4 Summative assessment

The teachers had a long standing policy of administering pen and paper based tests as a final summative task to the topics that were taught. This practice continued in the Astronomy unit. However, a key salient outcome for the teachers was the multiple modes of representation that the students displayed in their learning journals. This prompted a change to open-ended questions given on the final test challenging students to construct representations and providing a space rather than the traditional lines for students to respond. Figure 6 shows the use of this expanded space for student responses to a test question asking, “An astronomer investigating the motion of *Europa*, which is a moon, or natural satellite, of the planet *Jupiter*, found that it *revolved* as well as *rotated*. Use the space below to clearly explain what each of these motions mean.”

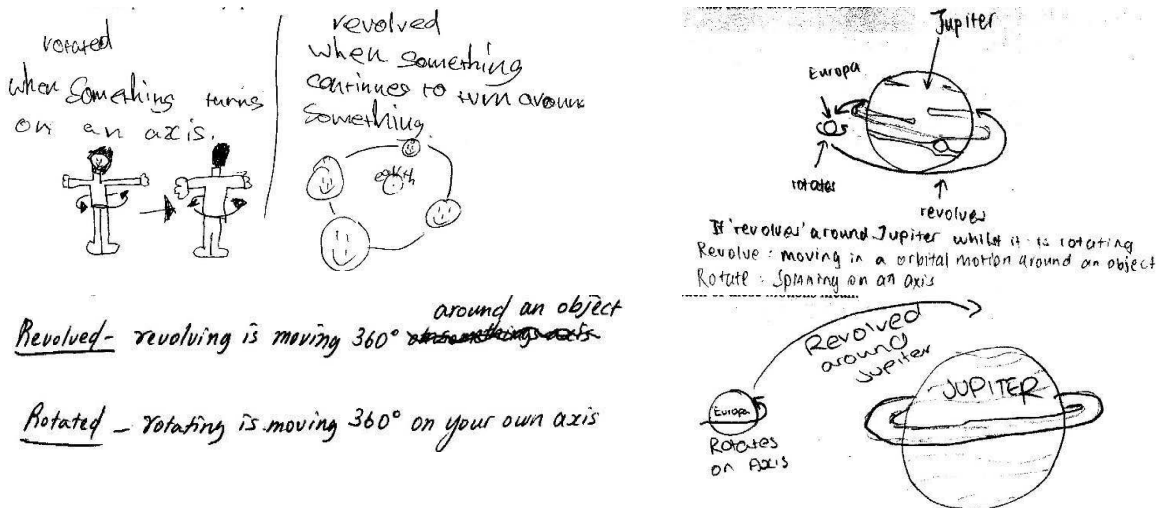

Figure 6. Student responses to a test question

In reflection of finding different ways in which the students responded to test questions the teachers commented:

In their test answers if we gave them the space they would perhaps do a diagram to help with explanation or we might say use representation, they didn't just stick to the words (Jaz).

And it valued those boys that do like to draw (Alice).

Following the Astronomy teaching sequence Alice made mention of a continued practice in providing a space for students to respond to test questions.

And even with our year 8 exam last semester [outside of the Astronomy topic] like in our extended response more inquiry based we opened it up that they could represent that knowledge in multiple ways (Alice)

4.5 Teacher collaboration

The collaboration among the teachers in the past was “*more where are you up to in the text book rather than what the activities are (Jaz)*”. The experience in teaching the Astronomy topic was more collaborative and associated with the joint commitment to supporting deeper level student understanding around a conceptual focus. It was more about discussing and sharing representational issues with teaching and learning the concepts.

I think we kind of went away from what's in the chapter of the text book that we need a cover into more what key ideas or understanding that we want the boys to take away at the end of the topic (Alice).

Rather than following the textbook, the introduction of a pedagogy built around a coherent conceptual focus gave the teachers, “*a bit more fluidity as well and flexibility with what we can do as we go (Alice)*.” With the collaborative planning of topics from a conceptual focus there is now an emphasis on pre-testing of ideas (mentioned above) and, “*being very conscious of trying to put in representative stuff (Kate)*”.

Following the astronomy topic the teachers maintained their diminished focus on the textbook. This finding is reflected in the following comment:

I'm not as text book oriented. I found that I don't set questions out of text book or the E book anymore. I just give them a task that suit where they're at and there will be homework tasks that follow on, it's more of a representational deal (Jaz).

The affordances offered by the representation construction pedagogy for collaboration around student conceptual learning also provided the opportunity for mentoring work amongst the teachers, with those with more experience or productive ideas helping the others, especially new staff as they came on board, with understanding and implementing the approach in novel ways.

4.6 Representational construction approach as inquiry

The teachers perceived the representation construction approach as one in which the teacher might implement an inquiry approach that supplements textbook teaching. These views are reflected in the following comments:

I think it's given us an actual tangible way to do the inquiry base that's an easier way for most staff to sort of like cause when we talk inquiry base they think open ended the kids are going to be all over the shop hey whereas this kind of gives them that ability to have inquiry learning but in a different way (Kate).

Oh it's just reinforced that sometimes text books aren't the answer to all science teaching and if you mix it up I think that's the best approach rather than flogging this textbook idea. I think if you can bring something like this inquiry based learning as a different approach I think that's only going to benefit the kids learning (Jaz).

The teaching approach is perceived to be effective “because they're learning by doing it they're not just rote learning or trying to remember facts (Kate)” and “having to explain it someone else or to put down what they know (Jaz)”.

5. Discussion and conclusions

The four teachers demonstrated change in their current practices in implementing the representation construction approach. In relation to the literature on effective professional development (for example, Loucks-Horsley et al. 2010) the CRISP project directly aligned with student learning needs; was connected to practice; focused on the teaching and learning of specific academic content, and; provided time and opportunities to collaborate. The Salsa College teachers had ongoing time and opportunity to collaborate and build strong working relationships. In addition, the CRISP intervention was continuously monitored and evaluated by the CRISP researchers and teachers.

The IMPG model proved useful in unpacking the domains of teacher learning and their interconnections for each of the themes discussed, and also the way the external input operated to support these domains. It enabled us to see the model as consisting of essentially two parts; the enactment of teacher learning consisting of interconnections between the practice, salient outcome and knowledge and belief domains, and the external input which ideally is operationalized to trigger and support these interconnections. The requirement and opportunity for teachers to practice was of critical importance to their learning. For the Salsa teachers classroom enactment provided the basis for collaboratively exploring and honing strategies. The key student outcomes of engagement in classroom activity and discussion, and learning, and realisation of the salient features of teacher practice, were central to learning. Deeper-level student outcomes were realised with more confidence and there was more opportunity to explore the practice-belief-salient outcome cycle through ongoing iterations. Changes in teacher knowledge and beliefs both arose from and fed into their classroom practices and judgments of outcomes, and the Salsa teachers were coherent and confident in their learning. The coherence of the pedagogy and its exemplification in practical classroom activity was important in capturing the commitment of the teachers to their learning cycle.

The external input had core features that were important for teacher learning outcomes. A key feature was the provision of a coherent perspective on learning in science, with illustrative, practical classroom activities flowing from this. The building of collaborative discussion was important and built around planning, implementing and interpreting classroom practices. From the perspective of the IMPG model we found that the domain external to a teacher is highly complex, consisting in our case of university experts, curriculum resources, and also the community of teachers involved. The teachers found that the curriculum resources that included pre-tests with student results from previous research, key ideas and alternative conceptions pertinent to the topic and a variety of activities with a representational focus (with student samples) highly useful in interpreting and adopting elements of the representational construction approach. The teachers also saw benefit in workshop activities where the approach was modeled in addition to discussing and sharing ideas with university staff and other participating teachers. The shaping and coordination of the resources exemplifying the innovation is critical for successful implementation. The importance of peer collaboration is apparent in our data, such that input and feedback from colleagues acts as a critical supplement to the input provided by the researchers.

One can't treat an innovation as a unitary thing but need to think of the Interconnected Model of Professional Growth (IMPG) separately for each aspect of the innovation. In the findings above for the Salsa teachers, change networks were seen with the pre-test and alternative conceptions theme and the student workbook theme. Whilst not shown in this paper change network diagrams may have been constructed for each teacher

in the other themes such as collaboration, summative assessment and meta-representational teaching. Whilst the IMPG model needs to be considered separately for each aspect of the innovation connections can be made between change sequences and networks. For example, the change network for Alice in using learning journals reported on the formative assessment opportunities of the student entries in the journal. The journal entries gave insight into the students' thinking including if they have misconceptions. Alice then views the learning journals as supporting the other theme discussed in this paper, which relates to pre-tests and misconceptions. Therefore the two themes are connected to the misconceptions viewed in the learning journals.

Finally, we found variation with the IMPG when thinking about how this model might fit with the implementation of the pre-tests in the Astronomy topic. The model as presented by Clarke and Hollingsworth (2002) (Fig. 1) does not allow enactment from the external domain to the domain of consequence. We found that the teachers initially viewed the pre-test as being associated with research and university researchers. However, the prevalence of misconceptions was considered a salient outcome by the teachers. This supports a link between the external domain and domain of consequence. However, another interpretation is that the administration of the pre-test represents information in the external domain. In this interpretation the teachers reflected on the student results to then change their practice to address the misconceptions elicited.

In terms of implications for scaling up research-developed innovation, the implications of the analysis are not straightforward. Clearly the CRISP project is able to provide more convincing and deeper evidence of teacher learning and of student learning, but this comes at a cost of greater researcher time commitment. It is our hope that at Salsa and other schools we are working at the seeds will be sown for extension of the approach to other teachers and perhaps nearby networks of schools, using the growing experience and confidence of this first generation of teachers.

References

- Australian Curriculum, Assessment and Reporting Authority (ACARA) (2010). Australian Curriculum: Science. Retrieved from <http://www.australiancurriculum.edu.au/science/Rationale>
- Clarke, D., & Hollingsworth, H. (2002). Elaborating a model of teacher professional growth. *Teaching and Teacher Education, 18*, 947-967.
- Ford, M., & Forman, E. A. (2006). Refining disciplinary learning in classroom contexts. *Review of Research in Education, 30*, 1-33.
- Hubber, P. (2010). Year 8 students' understanding of astronomy as a representational issue: Insights from a classroom video study. In D. Raine, L. Rogers & C. Hurkett (Eds.), *Physics community and cooperation: Selected contributions from the GIREP-EPEC & PHEC 2009 International Conference* (pp. 45-64). Leicester: Lulu, the Centre for Interdisciplinary Science, University of Leicester.
- Hubber, P., Tytler, R., & Haslam, F. (2010). Teaching and learning about force with a representational focus: Pedagogy and teacher change. *Research in Science Education, 40*(1), 5-28.
- Hubber, P. (2013). Teacher Perspectives of a Representation Construction Approach to Teaching Science. In R. Tytler, V. Prain, P. Hubber & B. Waldrup (Eds.), *Constructing Representations to Learn in Science* (pp. 135-149). Rotterdam: Sense Publishers.
- Lehrer, R., & Schauble, L. (2006). Cultivating model-based reasoning in science education. In K. Sawyer (Ed.), *Cambridge handbook of the learning sciences* (pp. 371-388). Cambridge, MA: Cambridge University Press.
- Lemke, J. (2004). The literacies of science. In E. W. Saul (Ed.), *Crossing borders in literacy and science instruction: Perspectives on theory and practice* (pp. 33-47). Newark, DE: International Reading Association and National Science Teachers Association.
- Tytler, R., Hubber, P., Prain, V., & Waldrup, B. (2013). A representation construction approach. In R. Tytler, V. Prain, P. Hubber & B. Waldrup (Eds.), *Constructing Representations to Learn in Science* (pp. 31-45). Rotterdam: Sense Publishers.
- diSessa, A. A. (2004). Metarepresentation: Native Competence and Targets for Instruction. *Cognition and Instruction, 22*, 293-331.

- Loucks-Horsley, S., Stiles, K., Mundry, S., Love, N. & Hewson, P. (2010) *Designing Professional Development for Teachers of Science and Mathematics* (3rd ed.), Thousand Oaks, CA: SAGE
- Kalkan, H. & Kiroglu, K. (2007). Science and nonscience students' ideas about basic Astronomy concepts in preservice training for elementary school teachers. *The Astronomy Education Review*, 1(6), 15-24.
- Zeilik, M., Schau, C., & Mattern, N. (1998). Misconceptions and their change in university-level Astronomy courses, *The Physics Teacher*, 36(1), 104-107.

Affiliation and address information

Peter Hubber
Faculty of Arts & Education
Deakin University
221 Burwood Highway
Burwood, Victoria
Australia, 3125
e-mail: phubber@deakin.edu.au

Gail Chittleborough
Faculty of Arts & Education
Deakin University
221 Burwood Highway
Burwood, Victoria
Australia, 3125
e-mail: gail.chittleborough@deakin.edu.au

Laboratory Activities and the Perception of Students

Daniela Marocchi, Marina Serio

Dept. Physics, University of Turin

Abstract

The perception students have towards laboratory activities has been analyzed on the basis of the results of a questionnaire. It has been examined a sample of 99 High School students and about 270 university students, the latter attending the three years of the Physics Bachelor degree course at the University of Turin. It has been considered interesting to analyze the perception students of different ages and school levels have towards laboratory activities. After a preliminary phase of study on the expectations and the perceptions of the students related to laboratory activities, we decided to conduct a more detailed analysis of the students' opinions evolution. We investigated different aspects, such as comprehension of the concepts of Physics, interest in laboratory activities, complementary nature of laboratory activities and classroom lectures. Questions were gathered together into some main streams:

- The usefulness of laboratory to attain a greater comprehension of Physics;
- The interest in and the complementary nature of laboratory activities and classroom lessons;
- Increasing of the capacity to use other instruments, whether of an informatics type or others (not presented here);
- The usefulness and ease of use of the informatics instrumentation. (not presented here)

We then conducted an analysis for each question by means of a chi-square test, considering a null hypothesis, which followed a simple uniform statistical distribution. We also analyzed the elements that students considered as positive or negative in laboratory activities during their years of learning. The analysis work conducted on the questionnaire responses has pointed out some considerations that offer several ideas, which could inspire future didactic programming.

Keywords

Physics education; Survey; Laboratory activities

1. Introduction

Within the teaching of scientific subjects didactic laboratory activities, are a fundamental way of learning for students thanks to their own distinctive complementary to classical face-on lessons, [see for example Schawb, 1962; DeBoer, 1991; Hofstein and Lunetta, 2003; National Research Council, 2006].

The objective of laboratory activities is not only the demonstration of concepts, laws and procedures. There are some other important achievements such as the attainment of a greater maturity and autonomy of thought by students, an enlarged capacity of cooperation and the use of multiple types of instruments in order to reach a result (Hodson, 1993). In the laboratory it is possible to develop learning modalities, such as that of "cooperative learning" (groups of students that collaborate/cooperate in a work of in-depth analysis and learning that leads to the building of new knowledge in order to reach a common objective- Johnson et al., 1981; Johnson & Johnson, 1985; Lazarowitz & Karsenty, 1990) and "learning by doing" (the action and experimentation of situations, duties and roles in which the subject, as an active participant, finds himself/herself in a position in which he/she must use his/her own resources and competences to elaborate and/or reorganize theories and concepts in order to reach an objective - Lazarowitz & Tamir, 1994).

Nevertheless, students (and on occasion some members of the teaching staff) often give greater importance to those subjects more closely related to on-face activities than to the laboratory ones. This tendency is shown sometimes in High School, where not all the students are interested in scientific subjects, and where teachers are often not prepared to plan or conduct laboratory activities and frequently underestimate their importance (see for discussion Tamir, 1989; Yung, 2001; Loucks-Horseley & Matsumoto, 1999). Unfortunately, teachers' education does not give enough weight to how a process of information acquisition is obtained, nor a correct idea of the hierarchies that exist between the various activities proposed to students

is given. As Hofstein and Lunetta (2003) argue, the lack of information on best professional practices and the misunderstanding of rationale behind such suggestions influence students' perception and their behavior in laboratory. It is indisputable that the teacher can create intelligent and educational activities for students only after having learned the essential concepts, methods and technologies (Wenning, 2011; Domin, 2007; Redish et al., 1998, Hammer, 1989, 1994a, 1994b; Hart et al., 2000).

The Italian High School reform has established the teaching of Physics from the first year of higher education (14 years old students, on average), when the students have not developed a mathematical knowledge and maturity strong enough to allow them to deal with complex topics in a rigorous way. In this sense laboratory activities become important in order to improve the knowledge of concepts and principles through the result of concrete experiences (Freedman, 2002). Laboratory activities in fact engage students in events in which they can investigate, identify problems and try to suggest modelling solutions. They can also learn to express results in different languages (natural and formal, both analytical and graphic) and to interpret them in the light of their previous knowledge, getting to understand how to initiate/inhibit a process or how to vary the behavior of a system (Sassi & Vicentini, 2009).

Laboratory sessions can become a general learning moment, because of the broad possibilities of increasing students' autonomy of actions in various fields. Elawady and Tolba (2009) report that in hands-on laboratory all the educational goals (Conceptual understanding, Design Skills, Professional skills, Social Skills,) are present with a strong emphasis on the first two (Conceptual Understanding and Design Skills). It could therefore be important to value all these different aspects in the educational curriculum, gradually proposing activities and requests that would make it possible to put into practice all the mentioned skills, and to assess them in a suitable way. Lab reports offer to students the chance to depict more aspects of their laboratory work (Haagen-Schuetzenhoefer, 2012). Laboratory activities can play an important role in growing inquiry capabilities and scientific understanding as well (Hofstein, Shore, & Kipnis, 2004). Experiencing what research activities mean allows students to develop possible potentialities (Chiappetta & Koballa, 2006) which could also be important for future choices. Deacon and Hajek (2011) present all these and even more reasons in their work.

However, the current restriction of funds and technical staff in Italy, together with the increasing number of students in each class and the reduction in the hours reserved to the various activities, makes more and more challenging for teachers to carry out teaching based on laboratory activities. The gap between what we propose as necessary for a adequate teaching of Physics and what teachers are actually able to do so increases. Textbooks do not help very much: the sections dedicated to the presentation of problems connected to experimental activities, to the correct analysis of data, to the writing of results or the drawing and reading of a graph, are very restricted and often relegated to the first chapter, without any connection to what the text develops later on. The experimental method thus becomes an historical/philosophical part of the scientific learning and development process, and not a work methodology according to a succession of mental and practical steps.

Even at a university level, the importance of laboratory activities often appears more established on paper than in the real belief of the teaching staff. Perhaps the high demand on space, instructors' time (mostly for scheduling) and experimental infrastructure also contribute to this situation.

In this context we considered interesting to analyze the perception that students have towards laboratory activities by submitting a questionnaire to students of different ages and school levels, from the last years of high school up to the third year of university.

2. Preliminary study

Starting from 2005, the activities proposed as part of the Scientific Degrees Plan (PLS), with the aim of attracting High School students to scientific degree courses, allowed hundreds of young people to have part in numerous activities in the areas (very often the laboratories) of the Physics Department, University of Turin. At the end of the activities the students filled in a questionnaire to investigate, apart from the appreciation or lack of appreciation of the experience, some topics of general nature: how much time they spend in laboratory with their teachers and what they would have liked to know and study in more depth through the study of Physics. These activities involved more than 3000 students in the last years of High School during consecutive years.

Limiting the attention to the aspects of interest for this study, the averages for the questions on 'interest in the activities' and 'their usefulness for the comprehension of Physics', is 3.4 and 3.2, respectively, with a correspondence of 1 for "certainly no" to 4 for "certainly yes", with options of 2 "more not than yes" and 3 "more yes than not".

We developed a subsequent approach with some of the students who frequented the first year of the Physics degree course (about 50 responses) over the 2010-11 academic year. They had undergone at least 4 sessions in the laboratory, with the relative data searches and analysis. These students were given a form to fill in between the first and second modules of the Physics Laboratory I course (the first year introductory course on the management and analysis of experimental laboratory data). The questionnaire had the purpose to investigate the expectations of students and any possible disappointment compared to their previous expectations, after the first didactic period with a laboratory course. The first emerging factor was that after this first period of activity the expectations referred to having a “more interesting and applicative” course, even if the clarity of explanation was good (75%). Students also considered “of good clarity” (78%) the arguments presented by teachers but only 25% of the students declared that “the subjects were interesting”. 86% of the students stated that they would have preferred a greater development of the applicative part. A preliminary interpretation of the results thus reveals that they were not aware that, in order to obtain information from experimental data, they must be able to analyze these data according to methodologies that they can only acquire through a theoretical course. The second consideration is that the instrumentation used in the first year laboratory is delicate and students cannot manage it autonomously. They have to follow codified operations under the prescriptive control of an older student during the first part of the activity, and of a member of the teaching staff during the analysis phase: this fact undoubtedly reduces the attractiveness of the activity itself.

After these preliminary phases of study on the expectations and perceptions of students related to laboratory activities, we decided to conduct a more detailed analysis of the evolution of the opinions related to this type of activity.

3. Statistical survey characteristics

The objective of the study was to follow the temporal evolution of the approach to the laboratory and its different components, starting from the students of the IV and V years of High School and going on to students attending the III year of the degree course in Physics.

We made the analyses mainly during the 2011-12 academic/scholastic year and in particular during the spring-summer of 2012. University students participated in a further part of the analyses during the subsequent academic year. There were fewer responses in the second year than in the first year of investigation. A comparison of the distribution of the responses related to the same laboratories given during the two academic years (considering that during that period some teachers changed) showed that the situation remained nearly uniform, from a percentage point of view, enough to allow us to consider the responses of the students from the two cohorts together for each of the frequented laboratories. As for as the students from the High School, 99 pupils attending the IV and V years at the “Cocito” Scientific High School in Alba (Province of Turin) filled in the questionnaire.

In the secondary school, classes had not often the opportunity of directly participating in experiments, and the occasion offered by the PLS, to couple classroom lessons with laboratory activities, led to an increase in interest and in the expectations of the students. The teacher presented the subjects related to the thermodynamic cycle and to the operating principles and technical capabilities of a thermal engine before the laboratory activities. A significant number of students had greater experience in the laboratory than others; however, all students had taken part in laboratory experience focused on themes related to the transformation of energy and the use of renewable energy.

The participants in the investigation at the University were 270 students attending the first, second and third years of the Physics Bachelor degree at the University of Turin, where 6 obligatory laboratories are in operation (2 for each year of the course). Every student answered for the two laboratories of the year and some 3rd year students answered about I and II year laboratories also.

Laboratories are moments in which experiments refer to themes as close as possible to the subjects of the parallel face-on courses. The laboratory courses have also the objective of acquiring operative autonomy and coordination in the group, together with the capacity of using methods and technologies, to perform critical analyses and to obtain communication competences.

During the first year, the first laboratory session, which is held simultaneously with the Mechanics course, gives the basis for the analyses of experimental data and mainly deals with kinematic and dynamic experiments. The experiments are not complex and the pupils simply study the links between physical variables. The activities take place in the laboratory with groups of 4-5 students, under the control of a tutor (an older student from the Master degree course at university) and of the teacher. The laboratory instructional environment is the expository style (Domin, 2007; Dunne & Ryan, 2011), with a predetermined outcome and

a procedure to follow. During the second laboratory session of the first year course, students have acquired the notions of *Mechanics* and they are developing those of *Thermodynamics, Fluids and Mechanical Waves* in the classroom context. This second laboratory session involves more elaborate experiments using a deductive approach, where the relationship between the variables is not always direct; they concern thermodynamics, fluids and acoustics and require a more reasoned application of the principles of Physics presented during the lessons.

During the second year, after the *Electricity and Magnetism* course and the *Electromagnetism and Optics* course, students take part in activities related to circuits (third laboratory session), and to geometrical and physical optics (fourth laboratory session). In the laboratory session dedicated to circuits, the greater simplicity of the instrumentation that they have to use leads to an increased autonomy for students, who can therefore feel more involved and responsible for the development of the experiments.

The activities proposed in the laboratory session of the third year require students to have a greater capacity of autonomy in the mounting and calibration of the instrumentation, through the use of supplied manuals: the laboratory instructional environment is problem-based style, with students responsible for generating their own procedure. In the parallel course *Atomic and Solid State Physics* and *Introduction to Nuclear and Sub-nuclear Physics* teachers introduce the theoretical related subjects.

Overall, 99 responses were obtained from the high school, and more than 600 from the university students, which were divided into around 350 for the first year laboratories, more than 150 for the second year and about 100 for the third year laboratories. Not all students replied to all questions, so we reported the results as percentage of the total number of students in each laboratory that answered the question.

4. Analyses of the questionnaires

The administered Likert style questionnaire (agree – disagree) was similar to that proposed to university students in Canada (Deacon & Hajek, 2011). We decided to exclude some questions as they were less suitable for the examined sample, thus the number of questions was reduced from 23 to 15.

As already pointed out in the Deacon and Hajek (2011) research, we gathered the questions together into some main streams:

- The usefulness of laboratory to attain a greater comprehension of Physics.
- The interest in laboratory activities and the complementary nature of laboratory activities and classroom lessons.
- Implementation of the capacity to use other instruments (informatics or not informatics).
- The usefulness and ease of use of the informatics instrumentation.

The questionnaire also included two open questions on “What I like” and “What I do not like” in laboratory activities.

We analyzed the responses according to the four main streams indicated in the previous section and studied the percentage distribution of the responses for each topic/question, divided according to the year of attendance of the students. In the conclusions, whenever possible, an interpretative consideration with some suggestions for the next few years is given.

There were two series of values for each year for the university students, one for each of the proposed laboratories. The responses were catalogued with reference to 5 possible choices that were given in the question text: from “*certainly yes*”, that is, complete agreement with what was stated, to “*certainly no*”, that is, complete disagreement with the proposed reference statement. We did an analysis for each question, through a chi-square test, considering a null hypothesis, which followed a simple uniform statistical distribution. Therefore, the non-acceptance of the null hypothesis shows the presence of a diversified response which points out a change in opinion over the years, or a more positive opinion (or more negative) than the one foreseen for a pure proportional distribution.

Here we present only what concerns the first two points, where themes result related to each other; they examine the connections between what students study by face-on lessons and what they study in depth through laboratory activities.

For the three statements: “*The laboratory activities contribute to the enlargement of my preparation in Physics*”, “*The conducted activities are interesting*” and “*The part carried out in the classroom and that*

conducted in the laboratory integrate each other in a harmonious manner” student can express their degree of approval on the formulated hypotheses through the five choices that were given.

5. Usefulness for a greater comprehension of Physics

As far as the first question is concerned, the activity surely is considered useful in order to gain a greater comprehension of Physics: the responses that assert the non-usefulness or the complete non-usefulness of the laboratory activities for the comprehension of the subject have been irrelevant. The unsure responses show a maximum of about 12%.

When considering the trend of complete agreement (clearly yes) compared to agreement (yes), passing from the High School pupils to those of the third year of the degree course, a non-uniform inversion of opinion can be observed, which has also been pointed out in the chi-square test ($p=0.005$), and which is illustrated in Figure 1. The pupils in the High School agree (64%) and complete agree (32%), while the students in the third year of university indicated the opposite trend (28% of “yes” against 55% of “clearly yes”). The percentages of the two responses are more or less uniformly distributed for the first and second years of university ($p=0.93$).

In the Canadian research the percentage of agreement was about 50%, while complete agreement was about 25%. It is possible to hypothesize that the positive assessment of the laboratory activities is undeniable, but also that it becomes stronger as time passes and with a greater knowledge of the subjects, which tend to become more and more difficult to concretize without the aid of laboratory activities.

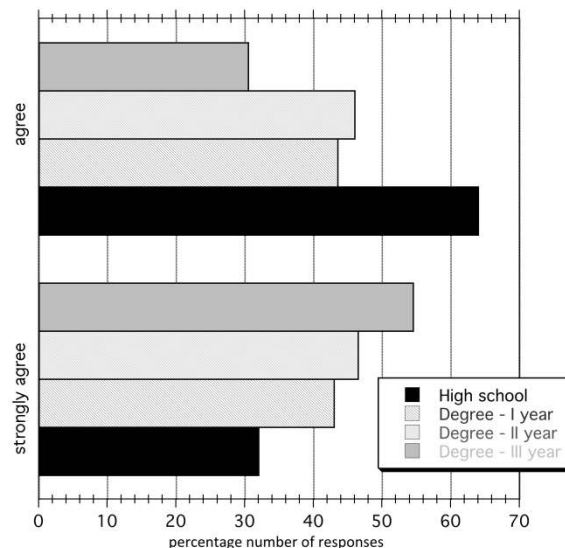

Figure 1. Trend of the percentage number of clearly positive and positive responses to the question “*The laboratory activities contribute to the enlargement of my preparation in Physics*” accord to the year of attendance.

6. Interest in the laboratory

As far as the question related to interest is concerned, the responses are not distributed overall according to a uniform trend ($p=0.0006$). Table 1 presents the distribution of answers to the question relative to interest in laboratory activities.

Table 1. Distribution of answers to the question ‘*Are the laboratory activities interesting ?*’

year	Laboratory	number of answers	clearly yes (%)	yes (%)	yes and not (%)	no (%)	clearly not (%)
High School	1	99	28	58	14	0	0
1 st Univ. Year	1	222	20	48	28	3	1
	2	121	18	52	28	2	0
2 st Univ.	1	149	32	44	21	2	1

Year	2	67	28	31	39	1	0
3 st Univ. Year	1	54	35	43	13	7	2
	2	52	33	42	15	8	2

In order to understand which cases are more distant from a uniform distribution, and if the disagreement is positive (I was more interested than expected) or negative (I was less interested than expected), we decided to group the responses into two categories (content: “clearly yes + yes, “and not content: “yes and no + no + clearly no”; see Figure 2). The following points emerged:

- Satisfaction in the High School was greater than expected.
- Less satisfaction was expressed at the University, although the result was not far from the uniform distribution ($p=0.16$), and showed a higher degree of dissatisfaction for the first year students and a lower degree for the third year ones.

Therefore we confirm once again what emerged before: the expectations of first year students are different, and only some of them are able to accept the fact that laboratory activities have also the function of acquiring knowledge and competences related to the analyses of experimental data. During the third year, the activities reveal more their characteristics of experimental verification of what the students acquire in the study of the theory of Physics, and this makes the analysis more corresponding to the expectations of interest of the students. So the mismatch between students expectations about the laboratory work and the teachers’ pedagogical intentions (Hart et al., 2000; Hodson, 1993; Hodson, 2001) decreases with time because of a greater maturity and a instructional style less focused on completion of tasks.

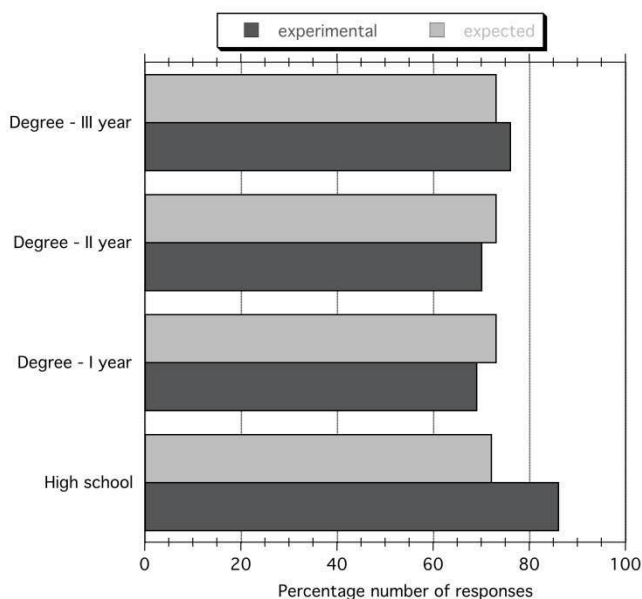

Figure 2. Comparison between the experimental values and the expected values concerning the satisfaction of the students, divided according to school, relative to interest.

7. Complementary nature of laboratory and classroom lessons

The same result emerges from the question related to the completion between the part in the classroom and that conducted in the laboratory “*The part carried out in the classroom and that conducted in the laboratory integrate each other in a harmonious manner*”, (the results are reported in Figure 3). If we consider the harmonization of the two paths, it is possible to observe that, with the passage of time, the students obtain a better perception of the situation, although there is a certain degree of oscillation. The chi-square test has shown, with $p=0.0003$, the significance of the percentage variation of complete agreement from High School (5%) to last university year (20%).

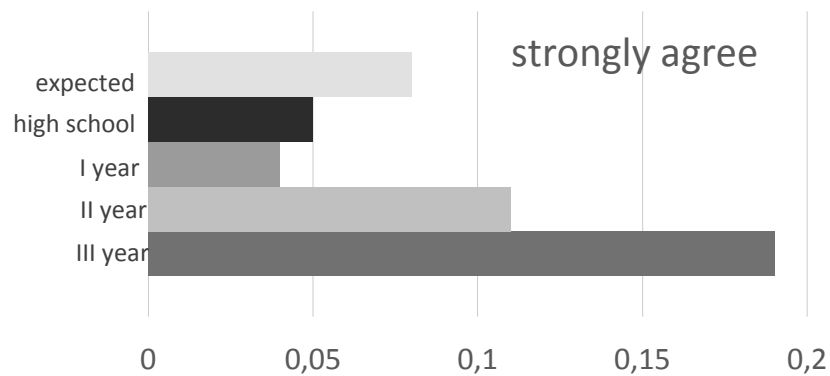

Figure 3. Distribution of the ‘completely agree’ to the question “*The part carried out in the classroom and that conducted in the laboratory integrate each other in a harmonious manner*”, versus the year of attendance.

When we analyze the distribution year by year, we find that in the first year of university there is a distancing from a uniform distribution ($p=0.04$) in a negative way: the students expected a greater coordination between the two didactic parts, which they clearly did not find. In fact, as it has already been pointed out, the laboratory courses in the first year include not only activities relative to the parallel Mechanics, Waves, Thermodynamics and Acoustics course, but also all the parts pertaining to the introduction to statistics and data analysis, which the students feel as not closely connected to the teaching of Physics. In the third year, they completely refused uniform hypothesis ($p=7 \cdot 10^{-5}$), but in a positive sense: the students recognized a clear complementarity between the two parts, which they consider to integrate and enlighten each other.

8. Open comments

Eventually there were the comments to open questions concerning laboratory practices that were considered enjoyable and those considered not enjoyable, how they were structured, how they were examined (Table 2). We can divide the responses by some fundamental characteristics that concern the proposed practices, the group work and data analysis modalities, the available technical material and the availability of the teaching staff and tutors.

Table 2. Grouping of the free responses to the question “*What do you like about the laboratory?*” and “*What do you not like about the laboratory?*”.

What I like about the laboratory	What I do not like about the laboratory
To experiment and verify the theories studied during the lessons, to obtain a greater comprehension of Physics and to develop manual skills.	The burden of the requested work (both for the measurements and for the analyses); physical and mental fatigue due to the 4 hour sessions; conflict with other courses
To understand the problematic nature of the experimental measurements and of their analyses	Lack of time and of the possibility of conducting experiments in an autonomous manner (first year)
Group work, acquisition of a critical mind, collaboration, contact and relationships with teachers/tutor, informal atmosphere	Boring practices, with very complex data analyses or excessive number for the considered didactic period
Autonomy in the management of the practices, construction of apparatus; possibility of varying the parameters in order to increase comprehension; more modern and interesting practices (in the second and third years)	The bad preparation of some tutors, lacking/obsolete/incomplete didactic material, laboratory data sheets not complete; obsolescence of instruments
	Groups are too numerous or with non-collaborative members
	Adequacy of what is required in the laboratory with what is explained during the lessons; too many technical aspects are taken for granted

	Very short times for the handing in of reports for the examinations; different software programs used in the different laboratories
--	---

High School students very often pointed out the concreteness of the activities in the enjoyable features of the laboratory, as well as the possibility of “seeing” what had been explained during the classroom lessons in a theoretical way relative to physical laws. At the same time they indicated among the negative features the necessity (often not clearly understood) of the need to repeat the measurements and the “heaviness” of the data analyses with the drawing up of reports about procedures, results and comments.

In the first year, among the negative points, the reduced operative autonomy came first, together with the lack of appeal of some of the proposed practices. In the subsequent years, there were more negative written replies concerning the lack of suitability of the teaching material (both relative to the lessons and to the data sheets and the instrument manuals in the laboratories), and pertaining to the instrumentation, which in some cases was considered obsolete. Students instead always judged positively the possibility of conducting experiments on the theoretical laws explained during the lessons, the group work modality and the closer and less formal relationship with the teaching staff, compared to lessons and exercises conducted in the classroom.

9. Discussion

Different considerations arise from the analysis of the responses to the questionnaires. In the preliminary phase of our investigation with first year university students, we noted their hope of having a “more interesting and applicative” course: 86% of the students stated that they would have preferred a greater development of the applicative part. This difficulty lowers with time; in particular, during the third year laboratory, the practices refer to physical laws not experienced directly on a daily basis, unlike what occurs in most of the Mechanics and Thermodynamics laboratory sessions. This fact produces a natural greater interest and curiosity among students and they more easily realize the aspect of having to concretize what has been learned during the face-on lessons. In any case, harmonization between the teachers of the classroom part and those of the laboratory part become fundamental in order not to lose the positive aspect of concretization of theoretical laws during laboratory activities.

What further emerge from students indications is that they do not like neither the presence of tutors (who further reduce their leeway) nor the methodological part of the course. It would be preferable for students to understand, starting from the High School, that they can obtain results only from the analysis of data and not simply from the conduction of experiments, perhaps experienced in a passive manner, nor from the collection of data without a connected discussion. From laboratory activity, students must understand what there is behind a result. Moreover, this experience has not to be reduced to a series of attempts conducted in a random manner, but it should be highlighted that actions must be predefined by an experimental idea of what should occur. Only in this way, through a priori hypotheses on the expected behavior (problem focusing phase), is it possible to plan suitable experimental procedures (planning phase, data collection and analyses) – (Sassi & Vicentini, 2009).

Without going into too much detail on the analyses, it is important that students acquire the concept of the inherent experimental error in measurement operations, whether connected to the instrumentation itself or to their incorrect behavior. Hence, they have to know the essential instruments for the correct data analyses. Currently the average situation in High Schools does not seem to be at this level as there is a lack of laboratory activities. Even when the laboratory activities take place, there is a limited development of what allows them to establish an appropriate basis of data discussion. Therefore the positive feedback of the students to the laboratory activities they have done, as well as the negative feedback concerning the necessity of analyzing data according to exact rules, are not surprising results.

Also in the university laboratories there is the risk of not attributing the right importance to the planning of the experiences and to the critical analysis of the results. The expectations of students who choose a scientific course, such as Physics, sometimes are not satisfied in the first year of university due to the needs of educational path. Students often consider the laboratory activities of secondary importance, compared to the parallel theoretical courses, and so they perceive as excessive the commitment required for their presence in the laboratory and, above all, for the analyses of the data and the drawing up of reports. After their first laboratory course, examination must investigate not only the acquisition of theoretical data analysis techniques but also, and above all, all the laboratory activities. Laboratory aspect has therefore to be valued

and kept into account in the same way as the acquired capacity of correctly carrying out Mechanical problems or Analysis exercises.

What is also observed is that students progressively overcome the initial difficulties and the lack of interest in acquiring basic methods for the statistical analysis of experimental data. The partially negative opinion expressed in the first year, mainly concerning the interest, gradually changes. Above all, students develop a great awareness about the acquisition of instruments relative to data analysis as a compulsory step towards the achievement of usable information gained from experimental activities. In order to reinforce this awareness it could be useful to introduce a moment of experimental activities involving direct contact with a research group. In our headquarters, the preparation of the thesis at the end of the three years Bachelor's degree engages many of the students in this way. Acting independently, they come to understand how the knowledge they have acquired is actually usable and necessary, not only in order to pass a specific exam. The preparation of the Masters' degree thesis (for which 45 educational credits are reserved), throughout guided research work and elevated autonomy and critical capacity, strengthen these convictions.

As for the aspect of autonomy in the management of experimental activities, which has resulted to be important for a great number of students, it appears to be difficult to realize for first year large cohorts at university. Unfortunately, the instrumentation is often expensive and it is not always able to come up to the students expectations, as can be seen from their answers. Moreover, the Mechanics and Thermodynamics laboratories generally use delicate instruments, which make necessary the constant presence of technicians and tutors. Electricity course (carried out during the second-year laboratory sessions for the examined sample) offers to students the possibility to work autonomously and makes the laboratory work more interesting and amusing. Independent laboratory experiences should also be exploited in order to make students learn how to plan what they want to obtain, and then to verify that they have acted correctly to reach the proposed objective. Whenever possible it would be useful, when working with relatively small groups of students, to leave them free to analyze data in an autonomous way according to their previously gained knowledge. It would be possible then to discuss what emerges and guide them towards the necessity of conducting a more detailed study of the theory that underlies the correct analyses of the experimental data: a "lab" means not only manipulating equipment, but also ideas (Hofstein & Lunetta, 2003).

From "*What do you not like about the laboratory?*" we find as answer the work in group, especially with not always collaborative members in the group. Laboratory activity gives the possibility to introduce students to team work. Teachers have to be careful to the dynamics installed within a group made up of students who did not know each other before. Students have to learn (as in a work environment) how to organize and "take advantage of" the different expertise of each member of the group, concerning both the analysis and the result production time. The questionnaire responses have highlighted that if the group is too numerous or with non-collaborative members students find difficulties in enjoying the team work and list it among the unpleasant features of the laboratory activities. On the contrary, it could be important to point out the educational value of team work, considering it together with all the other elements evaluated by teachers in the overall assessment during the examination. Overall, the planning activity of the experimental procedures should become a fundamental moment of the group work. During the third year laboratory sessions, students have to deal with the necessity of utilizing manuals that describe the properties of a used instrument, acting in a slightly more autonomous way. The group work of the third year requires students to increase their capacity of positive interaction, although at this stage the process becomes easier due to the fact that students know each other better (and thus can make choices that can favor interaction and collaboration).

Other interesting observations can be made looking the open comments as well. In particular, students emphasized "*the bad preparation of some tutors, lacking/obsolete/incomplete didactic material, laboratory data sheets not complete; obsolescence of instruments*". Students often complain about tutors' preparation. It could be important to take care of the preparation and the activities of tutors; although not compulsory, it can be a real moment of development of their competences and ability (Ryan, 2014). The preparation of tutors could therefore go beyond a simple "training" and involve codified operations, thus becoming an educational moment which would later improve their activities with their younger companions.

In a similar manner teachers have to dedicate a deep attention to the preparation of the laboratory material according to the different needs of each year of their courses. Laboratory data sheets should be able to guide students in the correct execution procedures when the length and complexity of activities connected to the gathering of data require certain guidance, considering the limited time students are present in the laboratory. It could be useful to start from very simple practices for which only the strictly necessary information should be supplied, and then to ask students themselves to draw up a laboratory data sheet containing the information they believe as necessary for a correct conduction of the experimental steps. Teachers have to

present detailed datasheets as a necessity in order to reach the objective, because when a preparation error occurs, students do not gather all the elements necessary for the analysis in the time available for the laboratory exercitation.

10. Conclusion

In this research we study the students approach to the laboratory, starting from IV and V years of High School and going on to students attending the III year of the degree course in Physics. We used a questionnaire and had answers from 99 students from the High School and 270 students attending the first, second and third years of the Physics Bachelor degree at the University of Turin.

The analysis work carried out on the questionnaire responses has pointed out some considerations, which had already been shared by the teaching staff, and offered some starting points which could inspire future didactic programing.

The main result from the questionnaire is that the way of working in groups, the autonomy in the management of the laboratory activities, the capacity of utilizing information and instruments in a critical manner and the experience of writing a correct and complete scientific report, all seem to be attainable during the typical laboratory educational activities of the three-year degree course. In conclusion, we can confirm that, through the analysis of the responses made, we are able to point out some critical points on which to work over the next few years, in order to maintain the educational aspect of laboratory courses and at the same time to broaden their educational capacity and the positive acceptance of them by students.

References

- Chiappetta, E. L., & Koballa Jr., T. R. (2006), *Science Instruction in the Middle and Secondary Schools*, 6th ed., NJ: Pearson/Merrill Prentice Hall.
- Deacon, C., & Hajek, A. (2011). Student perceptions of the value of Physics Laboratories. *International Journal of Science Education*, **33**(7), 943-977. DOI:10.1080/09500693.2010.481682
- DeBoer G.E., (1991), *A history of ideas in science education: implications for practice*, Teachers College: New York
- Domin D.S., (2007), Students' perceptions of when conceptual development occurs during laboratory instruction, *Chem. Educ. Res. Practice*, **8**(2), 140-152
- Dunne, J., and Ryan, B.J. (2012). Learning in the Science Lab: a New Approach. *Irish Journal of Academic Practice*, **1**, Article 2
- Elawady, Y.H. & Tolba, A.S. (2009). Educational Objectives Of Different Laboratory Types: A Comparative Study. *Int. J. Computer Sci. and Inf. Security*, **6** (2), 89-96. arXiv:0912.0932v1
- Freedman, M.P. (2002), The influence of laboratory instruction on science achievement and attitude toward science across gender differences, *J. Women Min. in Sci. Eng.*, **8**, 191 - 200
- Haagen-Schuetzenhoefer, C., (2012), Improving the Quality of Lab Reports by Using Them as Lab Instructions. *Phys. Teach.* **50**, 430-433, doi: 10.1119/1.4752052
- Hammer, D., (1989), Two approaches to learning physics, *Phys. Teach.* **27**, 664-670
- Hammer, D., (1994a), Epistemological beliefs in introductory physics, *Cogn. Instruct.* **12**, 151-183
- Hammer, D., (1994b), Students' beliefs about conceptual knowledge in introductory physics, *Int. J. Sci. Ed.* **16**, 385-403
- Hart C., Mulhall P., Berry A., Loughran J., Gunstone R., (2000), What is the purpose of this experiment? Or can students learn something from doing experiments?, *J. Res. Sci. Teach.*, **37**, 655-675
- Hofstein A and Lunetta V.N., (2003), The laboratory in Science Education: foundations for the twenty-first century, *Science Education*, **88**, 28-54
- Hodson, D. (1993). Re-thinking old ways: Towards a more critical approach to practical work in school science. *Studies in Science Education*, **22**, 85-142.
- Hofstein, A., Shore, R., & Kipnis, M. (2004). Providing High School chemistry students with opportunities to develop learning skills in an inquiry-type laboratory: A case study. Research report. *Int. J. Science Education*, **26**, 47-62. DOI:10.1080/0950069032000070342
- Johnson, D.W., Johnson, R. T., Maruyama, G., Nelson, D., & Skon, L. (1981). Effects of cooperative,

- competitive, and individualistic goal structures on achievement: A meta analysis. *Psychological Bulletin*, **89**, 55–63
- Johnson, D.W., & Johnson, R. T. (1985). *Learning together and alone: Cooperative, competitive, and individualistic learning* (2nd ed.), Engelwood Cliffs, NJ: Prentice Hall
- Keys, C.W., Hand, B., Prain, V., & Collins, S., (1999), Using the Science Writing Heuristic as a Tool for Learning from Laboratory Investigations in Secondary Science. *J. Res. Science Teaching*, **36**, 1065-1084
- Lazarowitz, R., & Karsenty, G. (1990). Cooperative learning and student academic achievement, process skills, learning environment and self-esteem in 10th grade biology. In S. Sharan (Ed.), *Cooperative learning, theory and research* (pp. 123–149). New York: Praeger
- Lazarowitz, R., & Tamir, P. (1994). Research on using laboratory instruction in science, In D. L Gabel (Ed.), *Handbook of research on science teaching and learning* (pp. 94–130). New York: Macmillan
- Loucks-Horsley, S., & Matsumoto, C. (1999). Research on professional development for teachers of mathematics and science: The state of the scene. *School Science and Mathematics*, **99**, 258– 271.
- National Research Council, (2006), *America's lab report : investigations in high school science*, Washington, DC: National Academies
- Redish E.F., Saul J.M., Steinberg R.N., (1998), Student Expectation In Introductory Physics, *Am.J.Phys*, **66**(3), 212-224; doi:10.1119/1.18847
- Ryan B.J., (2014), Graduate Teaching assistants; critical colleagues or casual components in the under graduate laboratory learning? An exploration of the role of post-graduated teacher in the sciences, *Eur. J.Sci. Math. Educ.*, **2**, 98-105
- Sassi E. & Vicentini M. (2009), Il laboratorio nella didattica della Fisica. *Giornale di Fisica*, **50**, 225-240. DOI: 10.1393/gdf/i2009-10111-0
- Schwab J.J., (1962), The teaching of science as inquiry. In *The teaching of science*, Schwab, J.J. and Brandwein, P.F.; Eds., Harvard University: Cambridge, MA, pp 1-103
- Tamir, P. (1989). Training teachers to teach effectively in the laboratory. *Science Education*, **73**, 59–69
- Wenning, C.J., Wester, K., Donaldson, N., Henning, S., Holbrook, T., Jabot, M., Truedson, J., (2011), Professional knowledge standards for physics teacher educators. *J. Phys. Tchr. Educ. Online*, **6**, 1-7
- Yung, B. H. W. (2001). Three views of fairness in a school-based assessment scheme of practical work in biology. *International Journal of Science Education*, **23**, 985–1005

Affiliation and address information

Daniela Marocchi
Physics Education Research Group
Department of Physics, University of Turin
Via P. Giuria 1
10125 Torino, Italy
Mail: daniela.marocchi@unito.it

Marina Serio
Fluidodynamic and Nonlinear Waves Research Group
Department of Physics, University of Turin
Via P. Giuria 1
10125 Torino, Italy
Mail: marina.serio@unito.it

Mathematical Model of the Didactic Structure of Physics Knowledge Embodied in Physics Textbooks

Eizo Ohno

Faculty of Education, Hokkaido University, Japan

Abstract

In this study, descriptions in physics textbooks are considered as the sign defined in semiotics. Charles Peirce's triadic model of the sign is used to analyze each description. Based on the models of experimental inquiry, we formulate three categories into which descriptions in physics textbooks fall. We then construct the basic components of our analysis using these categorized descriptions. The basic components are represented via the notion of classifications, and a one-way relation between classifications is proposed. The didactic structure of physics knowledge embodied in physics textbooks comprises linked classifications. This analysis allows us to use data from teaching plans and students' activities in actual science lessons. We apply our approach to analyze two physics textbooks used in secondary education and illustrate the organized structure of descriptions in physics textbooks as diagrams.

Keywords

experimental model, data model, theoretical model, sign, type, token, semiotics

1. Introduction

Scholarly knowledge of physics needs to be transformed into a didactic form. The didactic form is referred to as the "physics knowledge to be taught" form and is adapted for teaching physics in specific contexts. This form is further transformed into teaching material, which is then used by students in classrooms. The transformation is a fundamental process in the design of physics curricula. In mathematics education, the entire scheme described above is called "didactic transposition" (Bosch and Gascón, 2006).

Physics textbooks are important teaching materials. In science lessons, teachers teach and students learn physics using textbooks as the teaching materials. Descriptions in physics textbooks can also be interpreted as "physics knowledge to be taught" that is represented by texts, graphs, and figures. Teachers use physics textbooks so that students can interpret the descriptions in them and comprehend the "physics knowledge to be taught" embodied there. In other words, physics textbooks play the following roles: they are teaching materials in science lessons and "physics knowledge to be taught." Therefore, analyzing the descriptions in physics textbooks as teaching materials will indirectly reveal the underlying structure of physics knowledge embodied in them.

There have been numerous studies on textbook research (Pingel, 2009). Various methods of analysis of textual and illustrative materials in science textbooks have been developed and attempted (Khine, 2013), and semiotics is often employed in the analysis of texts. For example, social semiotics provides an integrated framework for analyzing textual and illustrative materials in English and science textbooks (Bezemer and Kress, 2010). However, the social semiotic approach does not focus on the use of textbooks in classrooms.

The didactic structures of the "physics knowledge to be taught" form and their visualizations have also been investigated. Drawing concept maps is one of the methods employed to represent the relational structure of our physics knowledge (Novak, 1998). Another method is called *noboriori-hyo*, a Japanese phrase (Kawakatsu, 2005) that was a drawing method invented to empirically express a series of learning activities as a table connected to the "physics knowledge to be taught" and the intentions of the teacher. Teachers draw *noboriori-hyo* tables according to their teaching experience and science textbooks.

In this study, we focus on the bilateral character of physics textbooks; teaching materials used in science lessons and the "physics knowledge to be taught" embodied in the textbook descriptions. First, we explain the fundamental notions of our approach. Descriptions in physics textbooks are classified into three categories based on the models of experimental inquiry. Each description is considered as the sign defined in semiotics. We use Peirce's triadic model of the sign. Second, we expound the theoretical framework of our analysis method. A mathematical model is proposed to illustrate the didactic structures of descriptions in

physics textbooks. Two physics textbooks used by secondary school students are analyzed as specific examples. The conclusion discusses the characteristics and potential features of our approach.

2. Triadic model of descriptions in physics textbooks

In this study, we consider a series of sentences in a physics textbook as a description. A glimpse at the descriptions in physics textbooks reveals the dual nature of the books. Physics textbooks explain scientific experimentations and observations. During science lessons, students execute activities according to the instructions in the textbooks. On the other hand, certain elements of descriptions in physics textbooks embody abstract concepts and universal laws of physics. Teachers design science lessons to elucidate the “physics knowledge to be taught” embodied in these descriptions. By reading these descriptions, students review the knowledge that is gained by studying. In this study, we discuss this dual nature of physics textbooks based on semiotics (Chandler, 2007).

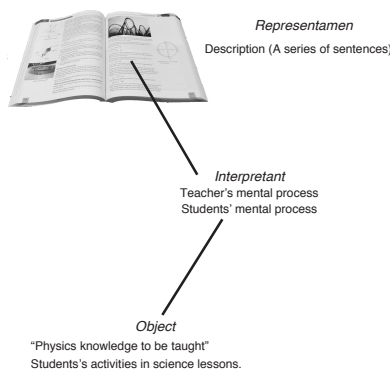

Figure 1. Triadic model of the descriptions in physics textbooks

We analyze the descriptions using Peirce's triadic model of the sign (Liszka, 1996). Peirce defined a sign as consisting of a *representamen*, an *interpretant*, and an *object*. A *representamen* is the form that the sign takes. An *interpretant* is the sense made of the sign. A sign in the form of a *representamen* creates its *interpretant*, and the sign stands for its *object*. We regard each description and picture in a physics textbook as a *representamen*. The *representamen* stands for an object that is “physics knowledge to be taught,” and students’ actual scientific activities. The *interpretant* is a teacher’s or a students’ mental process. A teacher interprets the *representamens* and designs student activities. Students interpret the *representamens* to comprehend the “physics knowledge to be taught” and to execute learning activities in science lessons. Figure 1 illustrates this triadic model of descriptions in physics textbooks.

3. Categories of descriptions in physics textbooks

Mayo (1996), citing Suppes’s (1969) ideas, proposed models of experimental inquiry. Experimental inquiry is delineated in terms of the following types of models: models of primary scientific hypothesis, experimental models and data models. Models of primary scientific hypothesis are also called primary models. They describe how to break down a substantive inquiry into one or more primary questions that take the form of estimating quantities of a theory. Experimental models connecting the primary models to data are concerned with relating primary questions to questions about the particular type of experiment at hand. Data models comprise the generation and modeling of raw data so as to put them into modeled data linked to the experimental models. Data models are also used to check whether generation of actual data satisfies various assumptions of experimental models.

We categorize descriptions based on how strong the *interpretant* of each description is related to the above three models. In other words, the model that is employed by the teacher and students to interpret a description determines the categorization of the description. The following basic categories are proposed:

Category A: questions, hypotheses, and theoretical models

Each section of a physics textbook generally has a primary scientific inquiry. This substantive question is categorized into questions and hypotheses. The questions are addressed and solved by theoretical models for testing hypotheses. The questions are considered significant for students and are reasonably capable of

being answered in science classes. Students learn theoretical models and comprehend ideas to explain phenomena using the models.

Category B: experimentation, observation, and empirical examples

Students engage in practical investigations and inquiring activities in science classes according to instructions provided in their textbooks. Descriptions in physics textbooks provide illustrative examples from daily life and given experimental data so that students can analyze such phenomena as thought experiments. Descriptions related to experimental models specify the key features of experiments. Students learn choice of experimental model, sample size, experimental variables, and experimental settings. Descriptions related to data models formalize raw data to apply analytical methods. Students understand analytical methods and graphical representation methods to answer questions framed in terms of the experiment.

Category C: review questions, and exercises

We focus on Categories A and B in this study. A description falls into Category A when its *interpretant* is mainly related to primary models. It falls into Category B when its *interpretant* is mainly related to the experimental models and/or data models. We analyze descriptions in physics textbooks using the triadic model demonstrated in Figure 1 to categorize them into Categories A and B.

4. Classifying descriptions

Let α denote a description in Category A and β a description in Category B. The description α presents general and universal statements containing abstract concepts and universal laws of physics. The *object* of α is “physics knowledge to be taught.” The description β denotes investigations and inquiring activities in science lessons. The *object* of β also includes empirical results obtained from those activities.

Students try to interpret a *representamen* assigned to α in order to acquire knowledge in physics (*object* of α). They combine α with some empirical results (*object* of β) obtained from an experiment they performed in a science lesson. A teacher designs an activity (*object* of β) in their science lesson so that students interpret a *representamen* of β successfully and acquire knowledge of physics (*object* of α). In this situation, we regard α as a *representamen*, and β as an *object*. We propose a triadic relation of α , β , and an *interpretant* in the minds of the teacher and students, as shown in Figure 2.

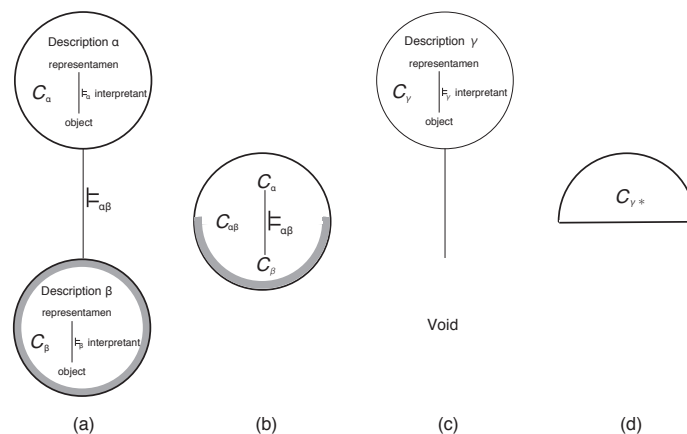

Figure 2. Classification and semi-classification

The relational structure in Figure 2(a) is called classification $C_{\alpha\beta}$. The symbol $\vDash_{\alpha\beta}$ refers to an *interpretant* related to the experimental models. The *interpretant* serves as a bridge between α and β . The bold gray circle shows that β is in Category B. This classification is a fundamental structure in our model. Figure 2(b) is a simplified schematic of Figure 2(a). The classification is a fundamental component in our model. In other words, α is a type and β is a token. Types are abstract and general, whereas tokens are concrete, specific events, states or processes (Wetzel, 2009). Each token is assigned to a type in the classification. This scheme is inspired by the theory of information flow (Barwise and Seligman, 1997) and we use similar notations and diagrams.

Figure 2(c) shows a description γ in Category A to which no description in Category B is assigned. The semicircle in Figure 2(d) is a simplified schematic of Figure 2(c). Tokens of this classification are shown as “Void” in Figure 2. We call the description γ in Figure 2(c) a semi-classification C_{γ^*} . In science lessons, to fill the void of C_{γ^*} , a teacher might incorporate experimental activities. With information on actual lessons, we can change the semi-classification C_{γ^*} to a classification. Our method connects the results of analysis indirectly to actual science lessons through the voids of semi-classifications.

5. Relational structure of descriptions in physics textbooks

Relations between classifications and semi-classifications determine the relational structure of descriptions in physics textbooks. Let ρ_i and ρ_j represent descriptions in the same category (A or B). There exists a one-way relation “ ρ_i partakes of ρ_j ”, which we write $\rho_i \rightarrow \rho_j$, when the two classifications meet any of the following criteria:

- i) The *representamen* of the description ρ_j includes an equivalent *representamen* of the description ρ_i .
- ii) The *interpretant* of the description ρ_j includes an *interpretant* and *object* of the description ρ_i . The process to interpret the description ρ_j requires understanding the description ρ_i .
- iii) The *object* of the description ρ_j includes an *object* of the description ρ_i .

The three conditions are not equivalent to “imply” and “entail.” The relation is not yet rigorously defined with exclusive commitment to logic. Some well-defined conditions of the relation are yet to be solved. Accumulating results of analysis might lead to the resolutions of this problem.

Let α_i and α_j be descriptions in Category A, and β_i and β_j be descriptions in Category B. Descriptions α_i and β_i compose a classification $C_{\alpha_i\beta_i}$. Descriptions α_j and β_j compose a classification $C_{\alpha_j\beta_j}$. If $\alpha_i \rightarrow \alpha_j$ and $\beta_i \rightarrow \beta_j$, then there exists a one-way relation “ $C_{\alpha_i\beta_i}$ partakes $C_{\alpha_j\beta_j}$ ” which we write as $C_{\alpha_i\beta_i} \Rightarrow C_{\alpha_j\beta_j}$ (see Figure 3). If only $\alpha_i \rightarrow \alpha_j$ is satisfied, then there exists a one-way relation “ $C_{\alpha_i\beta_i}$ partakes the type of $C_{\alpha_j\beta_j}$ ” which we write as $C_{\alpha_i\beta_i} \rightarrow C_{\alpha_j\beta_j}$. This means a situation in which students learn about α_i and α_j using completely different teaching materials. If only $\beta_i \rightarrow \beta_j$ is satisfied, then there exists a one-way relation “ $C_{\alpha_i\beta_i}$ partakes the token of $C_{\alpha_j\beta_j}$ ” which we write as $C_{\alpha_i\beta_i} \xrightarrow{B} C_{\alpha_j\beta_j}$. This means a situation in which students learn entirely different contents by performing one-way related activities referred to by β_i and β_j .

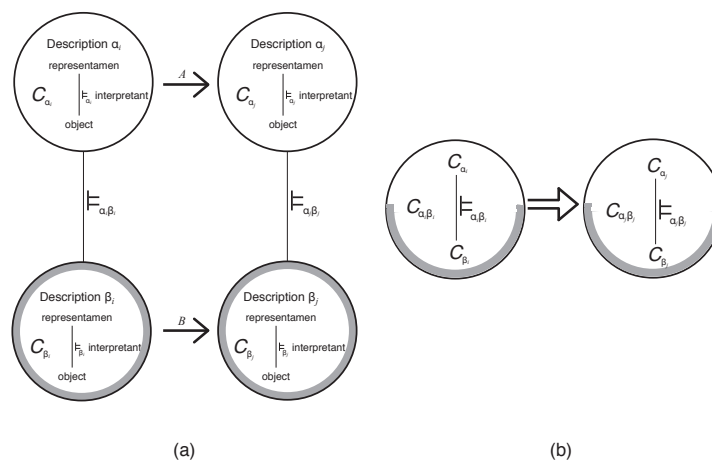

Figure 3. One-way relation $C_{\alpha_i\beta_i} \Rightarrow C_{\alpha_j\beta_j}$

6. Specific examples

Two physics textbooks A and B used in secondary education are analyzed as specific examples. Textbook A is the Japanese textbook *Butsuri Kiso* (Takagi, et al., 2012). It is the first book of basic physics for students aged 15 to 17, depending on their school curriculum. In this textbook, Chapters 1 and 2 are entitled “Motion of Objects” and “Force and Motion” respectively. We analyzed these two chapters and obtained classifications by the triadic model of descriptions. Textbook B is *General Certificate of Secondary Education (GCSE) Physics* developed for a concept-led physics course (Whitehouse et al., 2011). Students aged 14 to 16 take this physics course. A part of Chapter P4 “Explaining motion” is analyzed.

Figure 4 shows the relational structure of descriptions related to a topic “ $F=ma$ ” in textbook A as a diagram of the one-way relation described above. Textbook A describes three experimental activities in this topic. The diagram in Figures 5 is a rough sketch of relational structure of descriptions that reflects some structure of physics knowledge to be taught embodied Chapter 2 of this physics textbook. The sketch omits the details of the classifications. Small blue dot marks represent the descriptions in Category A. Small red dot marks represent the descriptions in Category B. Figure 6 shows structural differences between textbooks A and B. The right figure outlines the structure of physics knowledge embodied in Chapter P4 of textbook B obtained in the same way.

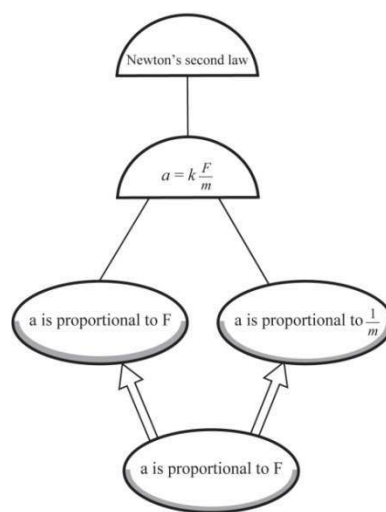

Figure 4. Relational structure of the classifications of Textbook A

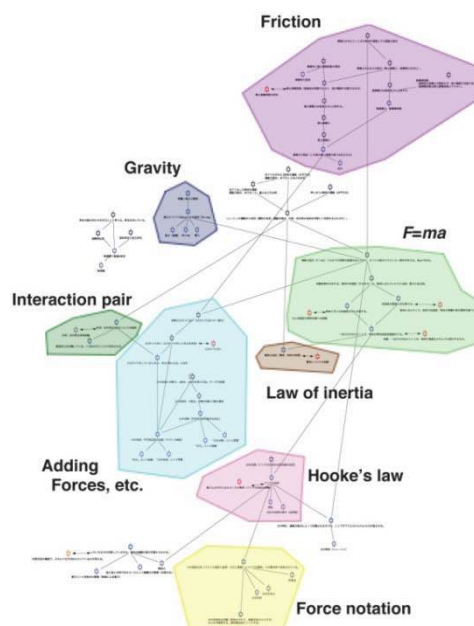

Figure 5. Rough sketch of relational structure of Chapter 2 in Textbook A

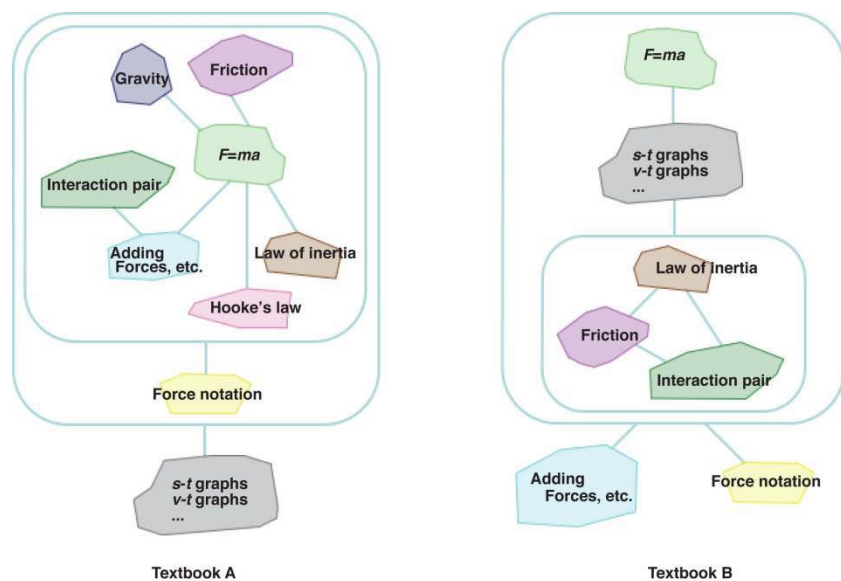

Figure 6. Structural differences between Textbooks A and B

We did not use any data from actual teaching plans or students' activities. The data forms the *interpretants* and *objects* in Figures 4 and 5. The analyses assume common teaching plans and activities based on textbooks and experience. If we obtain data from teachers' intentional instruction and students' specific behaviors, such information will modify the *interpretants* and *objects*. The modification will cause the diagrams in Figures 4 and 5 to change.

7. Conclusion and discussion

We have proposed a mathematical model of the didactic structure of physics knowledge embedded in physics textbooks. In this study, we created Categories A and B based on the models of experimental inquiry. Category A is related to the primary models and Category B is established in relation to the experimental models and/or data models. The descriptions in both categories were considered as the sign and analyzed using Peirce's triadic model of the sign. The descriptions were considered as the *representamen*. The *objects* mean "physics knowledge to be taught," teaching plans, teaching materials, and students' activities in science lessons. The descriptions as the *representamen* stand for the *objects* through the *interpretants* (the teacher's and students' mental processes). The basic components called classifications were created from the categorized descriptions. One-way relations between classifications were proposed. The relational structure of classifications was demonstrated by a diagrammatic expression.

The classification is the basic constituent of our analysis. It is considered as an expression of the data structure for representing the descriptions in physics textbooks. We can create a database on physics textbooks by combining the classifications and the data from the one-way relations between them. Such a database would be helpful in handling a large amount of diverse data and visualizing the relational structure of classifications. We can expand the data structure to add information on the teacher's intention and students' activities in science lessons explicitly through data from *interpretants* and *objects*. The database will be associated with rich and large data from science lessons. The usage of this data is a key question for future research.

Acknowledgement

This work was supported by JSPS KAKENHI Grant Number 26350180.

References

- Bosch, M. and Gascón, J. (2006). Twenty-Five Years of the Didactic Transposition, *ICMI Bulletin* **58**, 51-65.
- Berwise, J. and Seligman, J. (1997). *Information Flow: the Logic of Distributed Systems*. Cambridge University Press, Cambridge; NY.

- Bezemer, J. and Kress, G. (2010). Changing Text: A Social Semiotic Analysis of Textbooks. *Designs for Learning* **3**, 10-29.
- Chandler, D. (2007). *Semiotics: The Basics*. Routledge, NY.
- Kawakatsu, H. (2005). *Abstr. Meet (August 2005)* **55**, Society of Japan Science Teaching, 271. [in Japanese].
- Khine, M. S. (2013). *Critical Analysis of Science Textbooks: Evaluating Instructional Effectiveness*. Springer, Dordrecht; London.
- Liszka, J. J. (1996). *A General Introduction to the Semeiotic of Charles Sanders Peirce*. Indiana University Press, Bloomington.
- Mayo, D. G. (1996). *Error and the Growth of Experimental Knowledge*. University of Chicago Press, Chicago, see Ch. 5.
- Novak, J. (1998). *Learning, Creating, and Knowledge: Concept Maps as Facilitative Tools in Schools and Corporations*. L. Erlbaum Associates, Mahwah, N.J.
- Pingel, F. (2009). *UNESCO Guidebook on Textbook Research and Textbook Revision*. 2nd Rev. ed. United Nations Educational, Scientific and Cultural Organization, Paris.
- Suppes, P. (1969). Models of Data. In *Studies in the methodology and foundations of science*, 24-35. D. Reidel, Dordrecht, The Netherlands.
- Takagi, K., ... et al. (2012). *Butsuri Kiso (Basic Physics)*, Keirin-Kan, Osaka.
- Wetzel, L. (2009). *Types and Tokens : On Abstract Objects*. MIT Press, Cambridge, Mass.
- Whitehouse, M. (editor); Hall, A., ... et al. (project directors); Millar, R., ... et al. (authors) (2011). *General Certificate of Secondary Education (GCSE) Physics*. Oxford University Press, Oxford.

Affiliation and address information

Eizo Ohno
Faculty of Education
Hokkaido University
Nishi 7, Kita 11, Kita-ku,
Sapporo, Hokkaido, 060-0811 JAPAN
e-mail: eohno@edu.hokudai.ac.jp

Influence of Peer Method and IBSE on Science Competence on Chilean Secondary Students.

Nataly Rodríguez¹, Iván Sánchez², Ivo Fustos^{3,4}

¹ COEMCO; Concepción, Chile.

² Universidad del Bío-Bío; Concepción, Chile.

³ Departamento de Geofísica (DGEO), Universidad de Concepción, Concepción, Chile

⁴ Doctorado en Ciencias Geológicas, Universidad de Concepción, Concepción, Chile.

Abstract

The poor Chilean performance in tests, such as PISA, has evidenced the low level in scientific competences acquired during primary and secondary school. As a consequence of it, new methodologies to empower student in this area are needed.

With this as the main goal, our research was based on competence level variations in students from 15 to 17 years old. They were acquired during Physics class in a Chilean school. It was developed using a traditional methodology compared with two active methodologies: *Just in time teaching* (through Peer Method), and *Inquiry Based Science Education*. These results were analyzed through diverse statistical tests which compared the variation between a pre-test and a post-test.

Our results indicate that the students's competences level do not always improve using active methodologies in the Chilean classroom. Different factors should be considered in the learning processes. We conclude that for the active methodologies for the Chilean case, the students preparation is needed. Expressivity, confidence and team activities will be beneficial for our classroom system.

Keywords

Secondary Education; IBSE; Peer Method; Meaningful learning.

1. Introduction

The Chilean education experiments a critical time. Even if the international tests shows good results that consider our country as an educational leader in Latin American countries, these are below the average of the rest of the OECD countries. For example, in science the 34% of students are below level two of scientific competences. Moreover, only 1% of them achieved the highest levels (Agencia de Calidad de la Educación, 2013). Thus, the main implication corresponds that, in spite that the students have some science knowledge, they are unable to apply this knowledge outside the classroom (González *et al.*, 2009).

One of the reasons for this poor performance in scientific competences is related with the Chilean traditional education. The curriculum promotes the contents memorization and the student passiveness (Ahumada, 1998; Cárdenas, 2004). This cause a low interaction between the new information and the student's previous knowledge (Carretero, 2009). In other words, traditional learning is mainly focused in the verbal knowledge "delivered" by the teacher and "copied" by the student, centered in routine and individual tasks, where the student has to memorize and repeat the information in order to take a test (Pozo and Gómez, 2009). Furthermore, teachers tend to assign a greater importance to the conceptual contents over the skill and attitude developments. The Chilean teachers generally keep the curriculum without changes, doing exposition-based classes where they are the focal point (González *et al.*, 2009).

To enhance the students' scientific competences, was suggested a methodological change to develop the physics class: through Active Methodologies (AM): Just in Time Teaching through Peer Method (PM) and Inquiry Based Science Education (IBSE). These were compared with the traditional method, aiming to verify the effectiveness of each classroom methodologies in regards of the development of scientific competences in our students.

The PM and the IBSE have been widely studied by several authors, so, what then has this proposal to offer?

Our proposal shows some challenges: in Chile, the PM has been studied only at university-level, while the IBSE has been applied just in primary schools. This leaves a gap in the secondary schools, where there are not strategies that promote scientific inquiry or the development of scientific competencies by the Chilean students (Gonzalez *et al.*, 2009). These correspond to the main motivation behind this research, to answer the question: are there any significant differences between the use of different methodologies in terms of the development of scientific competence by high school students?

2. Methodology

The *Active Methodologies* (AM) are strategies where the student has the lead role in his own learning process. Thus, the protagonist of the learning process is the apprentice by himself, and the teacher has an accompany, guide, assess and support role for the student, so the student achieves independence and autonomy in his process (Fernández, 2006).

Independent the AM applied, these share some common goals, such as the development of intellectual capacities, communication skills, values and attitudes, supporting personal autonomy, encouraging teamwork and reflective practice, improving student metacognition, acquisition of meaningful learning and the development of interpersonal skills, among others (Luzón *et al.*, 2006; Exley and Dennic, 2007). Also, a greater level of interaction between students helps not only themselves, but it also helps to significantly decrease the gap between men and women in terms of their grades in physics (Lorenzo *et al.*, 2005).

2.1 Just in time teaching (Peer Method)

Just in time Teaching is a collaborative learning technique in which the interaction student-student and student-teacher is promoted, through the discussion of concepts during class (Mazur and Watkins, 2009).

To develop this strategy, we proceed as follow (Figure 1):

1. First of all, the teacher makes a brief lecture to introduce the concept.
2. Secondly, it shows a multiple-choice question aligned with the concept.
3. Then, the students discuss the questions in pairs and vote using clickers.
4. Finally, and according to the number of correct answers, the teacher has different options to continue:
 - If the correct answers are less than 30%, the teacher has to review the concepts again.
 - If the correct answers ranged from 30% to 70%, the teacher has to promote discussion among different groups of students, who will debate the right option to consider. After that, they have to vote again.
 - If the percentage of correct answers is over 70%, the teacher has to explain the next concept (Crouch and Mazur, 2001).

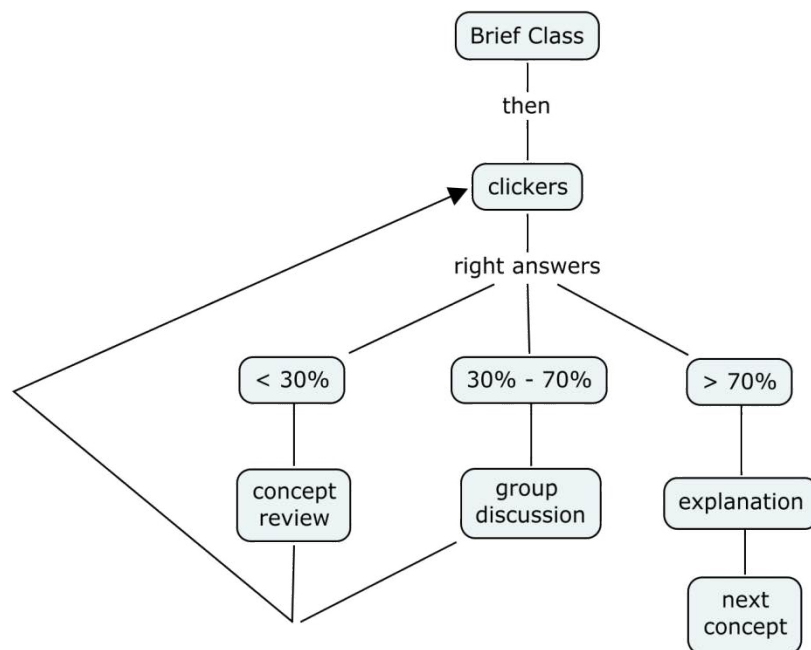

Figure 1. Peer Method process, adapted from Lasry (Lasry, 2008).

The advantages of this methodology correspond to his effectiveness during the working in big groups of students. Furthermore, it promotes critical thinking, helping to improve and solve problems with their partners (Rao and DiCarlo, 2000), besides, provides the feedback to develop the class properly.

Inquiry Based Science Education

The *Inquiry Based Science Education* consists in a group of activities in the laboratory where the students, opposite to the traditional laboratory sessions, have an active role, while the teacher acts like guide, orienting to the student. The student uses the scientific method to learn in different situations (Mora, 2005).

In this research, was implemented the *structured inquiry* (classifieds by Trnova and Torva, 2011). At this level, the teacher, using research questions, helps the students to develop an explanation for the phenomenon based on evidence obtained experimentally (Trna and Trnova, 2012) (See Figure 2).

This strategy present many advantages, for example, it allows to the students to relate the contents learned in a specific context, develop their innate curiosity, and his exploration capabilities (Trnova and Trna, 2011; Sánchez and Sierra, 2012). Furthermore, encourages to them to discover and rediscover in science, helping to promote scientific attitudes, showing that the scientific problems are not beyond their daily life (Mora, 2005; Castellanos and Zamudio, 2012). These develop the critical thinking, creating a positive attitude toward science (Trnova and Trna, 2011).

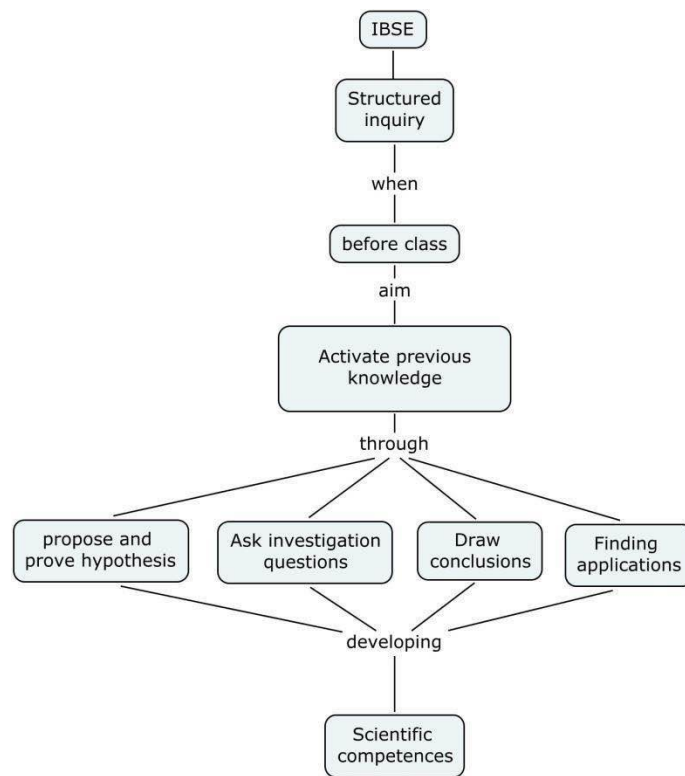

Figure 2. Inquiry Based Science Education

2.2 Implementation in Chile

Population and sample

The sample was constituted by 25 students from second year of secondary school (between 15 and 17 years old) from a private school. The next table shows the characteristic of the population and sample.

Table 1. Population and sample

	Experimental group	Control group
Total of students	21	21
Number of students who took the test	13	12

Like the majority of the inquiries in educational fields, this was implemented by a quasi-experimental design, because the groups were pre-established, not randomly selected (Campbell and Stanley, 1995). Two groups

participate in this research: an experimental and a control group. In the experimental group was implemented the IBSE methodology, while the lectures were developed by *Just in time teaching* using the *Peer method*. In the control group were implemented the same laboratory activities that in the first group, but after a traditional lecture. This was done during the thermodynamic chapter.

To compare the results obtained, was applied a scientific competences test in each group before and after the intervention, three months later. Our test consists in 23 questions, extracted from the PISA science test.

Table 2. Experimental Design.

	Pre test	Treatment	Post test
Experimental Group	Scientific competences test	Traditional lectures	Scientific competences test
Control Group	Scientific competences test	Peer method IBSE	Scientific competences test

3. Results and analysis

For a better understanding, our results were divided in two sections. The first section shows the results for each group in the pre and post test, while in the second section, is presented the comparison between the experimental group and the control group results.

3.1 Pre Test – Post test analysis

To analyze the impact of the new methodologies, we compare the difference between pre and post test for each group. In order to identify if our differences are significative statistically, was used the *Wilcoxon’s W* test.

Experimental group

The graph 1 shows the results obtained by the experimental group. This group worked with the PM and the IBSE.

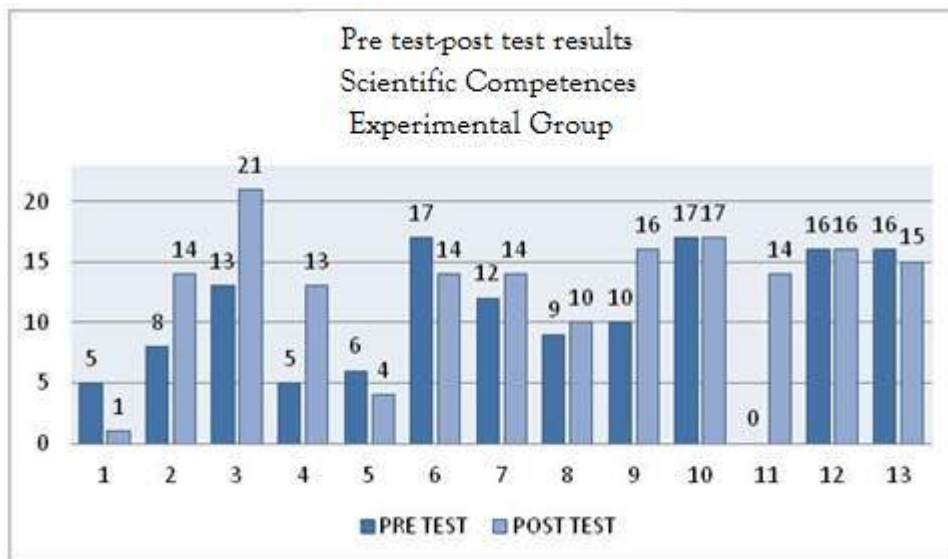

Graph 1. Experimental group: Comparison of the scores in scientific competences’ pre test-post test.

Graph 1 shows the scores obtained from each student in the pre and post test. To a first look, most of the students shifted their scores positively. Nevertheless, our statistical analysis shows that these results are not significant. We observe that the PM in conjunction with the IBSE do not cause a significative increase or decrease in the scientific competence level measurement by the test.

Control group

The graph 2 shows the scores of the control group, whose students had traditional lectures with the laboratory activities after those.

The results are not clear due to the heterogeneity of our results. These results shows that the traditional methodology, don’t affect the level of scientific competences achieved of the Chilean students. From the

Wilcoxon's W test, there is not a significant difference between the scores from pre and post test. Thus, from these results we can't conclude an improvement in the scores.

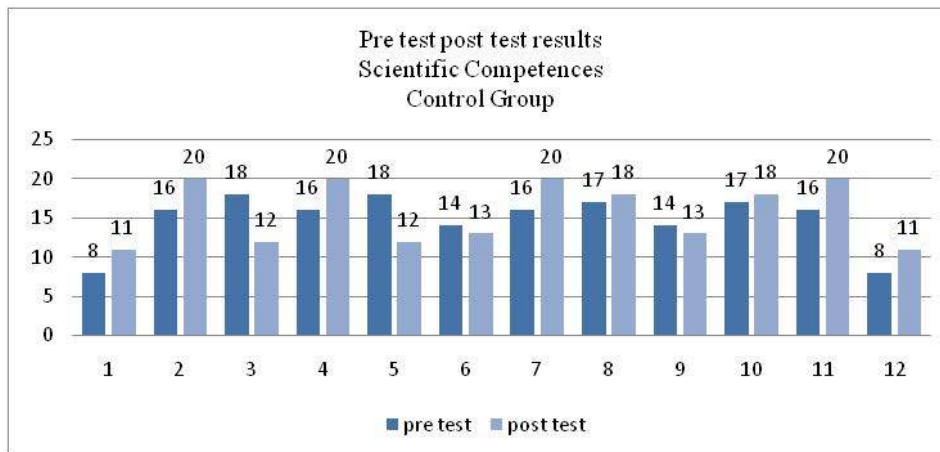

Graph 2. Comparison between scores in the Pre and Post test.

3.2 Comparison between experimental and control group.

In order to carry out this comparison between the average scores (see Graph 3), the *Mann Whitney's U* test was used. The *Mann Whitney's U* test establishes if there were or not any significant differences between the results of both groups. By the *p-value* obtained through the statistic test we concluded that in the pre-test there is a significant difference between the scores of both groups (*p-value*=0,03696). Nevertheless, the post-test results shows that there are not any differences between the results (*p-value*=0,5966).

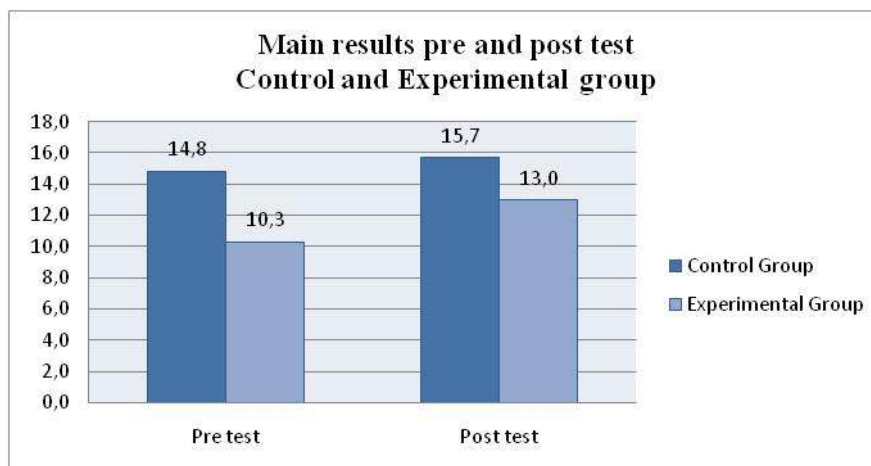

Graph 3. Pre test and post test main scores from control and experimental group.

4. Discussion

Nowadays, there are plenty of different opinions about the application of *Active Methodologies*; on one hand, some researches established that if the students use active methodologies they would improve their scientific competences (Rao and DiCarlo, 2000; Crouch and Mazur, 2001; Fernández, 2006; Lorenzo, Crouch and Mazur, 2006; Castellanos and Zamudio, 2012); on the other hand, there are some that do not see the potential in the application of these methodologies (Leeds *et al.*, 1998; Miguel, López and Martín, 2012). This research can be adjusted between both categories, because in spite of the positive results obtains, these were not as higher as expected.

One of the main factors that could influence the student results is their *socio-cultural characteristics*. The Chilean students are not used to participate or debate in class. The *Peer Method* needs the interaction and debate between the learners, and the environment of the classroom should be of confidence among them, to let them express their ideas freely. To stimulate the characteristics of this methodology in the Chilean students, before the implementation of this technique it should be applied a group activity to strengthen the

students' relationships and communication, and encourage them to participate in the class activities. Another important factor is the lecture *continuity* (Hernández, Javier and Martínez, 2013). In the school, the students have only 135 minutes of physics per week, 90 on Mondays and 45 on Fridays and as a consequence, they could not have the continuity necessary between the lectures. Unfortunately this is unavoidable in the Chilean system, which curriculum compel the schools to make only 90 minutes per week.

5. Conclusions

Neither the experimental group students nor the control group obtained significant differences in the results before and after the intervention. However, when comparing the results from both groups during the pre-test, it was observed that these were statistically different, whereas when making the same comparison with the post-test results, it was found that these were statistically similar. This variation can lead us to conclude that, though when analyzing individually the results of the experimental group these didn't present a significant variation, it does exist a small *improvement in the scientific competences level* achieved by this last group. Additionally, this investigation opens the door to a lot of questions that might be addressed in later investigations. Among these, we can find:

- Would the results be different if we apply these methodologies in different subjects?
- How would the results vary if we apply these methodologies in other educational levels? For example, in primary school the students tend to participate more. Would this improve the results?
- Considering that the school where these methodologies were applied is a private school with a lot of resources; what would be the level of achievement of the students of an under-resourced school?
- If the school doesn't count with a clickers system, it is still possible to perform the PM through the use of cards. Would the students react the same way?
- What would be the results obtained if we apply the methodologies for a longer time and without interruptions? Would the students have a better adaptation?

There are these and a lot of other questions that can be raised after this investigation. All of these have a common and only goal: to improve the learning processes and the acquisition of scientific competences by the students and increase their motivation in the scientific subjects.

References

- Agencia de Calidad de la Educación (2013) Resultados PISA 2012 Chile. Gobierno de Chile. <http://www.agenciaeducacion.cl/wp-content/uploads/2013/04/PISA-Programa-Internacional-de-Evaluaci%C3%B3n-de-Estudiantes.pdf> Visitado el 05/12/2013.
- Ahumada, P. (1998) Hacia una evaluación de los aprendizajes en una perspectiva constructivista. *Revista enfoques educacionales*, 2.
- Campbell, D. & Stanley, J. (1995) *Diseños Experimentales y Cuasiexperimentales en la Investigación Social*. Amorrortu Editores, Buenos Aires, Argentina.
- Cárdenas, C. (2004) Acercamiento al origen del constructivismo. *Revista electrónica Sinéctica* .24, 10-20
- Carretero, M. (2009) *Constructivismo Y Educación*. 1° Edición. Paidós Buenos Aires, Argentina.
- Castellanos, J. & Zamudio, J. (2012) ¿Cómo el Modelo Didáctico de Investigación Dirigida Aporta a la Adquisición de Actitudes Científicas Mediante la Construcción del Concepto de Excreción en Niños de Séptimo Grado? *Revista EDUCyT*; Vol. Extraordinario, 97-110.
- Crouch, C. & Mazur, E. (2001) Peer Instruction: Ten Years of Experience and Results. *American Journal of Physics*. 9, 970-977.
- Duit, R. (1996) The constructivist view in science education. What it has to offer and what should not be expected from it. *Investigações em ensino de ciências*, 1, 40-75
- Exley, K. & Dennick, R. (2007). *Enseñanza en Pequeños Grupos en Educación Superior*. Narcea, Madrid, España.
- Fernández, A. (2006) Metodologías Activas para la Formación de Competencias. *Educatio Siglo XXI*, 24, 35-56.
- González, C., Martínez, M., Martínez, C., Cuevas, K. & Muñoz, L. (2009) La Educación Científica como

- Apoyo a la Movilidad Social: Desafíos en Torno al Rol del Profesor Secundario en la Implementación de la Indagación Científica como Enfoque Pedagógico. *Estudios Pedagógicos XXXV*, 1, 63-78.
- Hernández, R.; Javier, F. & Martínez, C. (2013) Factores de Ineficacia Escolar. *REICE Revista sobre Calidad, Eficacia y Cambio en Educación*. 12, 103-118.
- Lasry N. (2008) Clickers or Flashcards: Is There Really a Difference? *The Physics Teacher* 4, 242-245.
- Leeds, M.; Stull, W. & Westbrook, J. (1998) Do changes in classroom techniques matter? Teaching Strategies and their effects on teaching evaluations. *Journal of Education for Business*, 74, 75-78.
- Lorenzo, M., Crouch, C. & Mazur, E. (2006). Reducing Gap Gender in the Physics Classroom. *American Journal of Physics*, 74, 118-122.
- Luzón, G., Carmona, J., Cebrián, S., Morales, J. & Villar, J. (2008). Aprendizaje Basado en Proyectos en Asignaturas Optativas de Física Nuclear y de Partículas. *II Jornadas de Innovación Docente, Tecnologías de la Información e Investigación Educativa en la Universidad de Zaragoza, Zaragoza*.
- Mazur, E. & Watkins J. (2009) *Just-in-Time Teaching and Peer Instruction*. In S. Simkins and M. Maier, editors, *Just in Time Teaching Across the Disciplines*, 39-62.
- Miguel, J.; López, D. & Martín, M. (2012) ¿Una participación Activa del Alumno Pronostica una Buena Nota en el Examen? *Working Papers on Operation Managment*, 3, 71-83.
- Mora, A. (2005). La Investigación Dirigida. *VII Congreso Nacional de Ciencias. Exploraciones fuera y dentro del aula*. Santo Domingo de Heredia, Costa Rica.
- Pozo, J. & Gómez, M. (2009) *Aprender y Enseñar Ciencia* 6º edición. Ediciones Morata, Madrid, España.
- Rao, S. y DiCarlo, S. (2000) Peer Instruction Improves Performance On Quizzes. *Advances in Physiology Education*. 24, 51-55.
- Sánchez, C. y Sierra, C. (2012) Diseño E Implementación De La Unidad Didáctica “Alimenta Tu Cuerpo Energiza Tu Vida” Con Un Enfoque De Investigación Dirigida En El Colegio Distrital Bravo Páez. *Revista EDUCyT*; Vol. Extraordinario,. 213-234.
- Sanmartí, N. (2002) *Didáctica de las Ciencias en la Educación Secundaria Obligatoria* Editorial Síntesis, Madrid, España.
- Trna, J. & Trnova, E. (2012). Inquiry-based Science Education Experiments. In Inquiry-based Science education in Europe: Reflections from the PROFILES Project, Bolte, C., Holbrook, J y Rauch, F. (editores). Berlin: Freie Universitat Berlin, pp. 212-215.
- Trnova, E. & Trna, J. (2011) Hands-on experimental activities in inquiry-based science education. *In Proceedings book of the joint international conference MPTL'16- HSCi 2011*, Ljubljana (Slovenia): University on Ljubljana, 293-298.

Affiliation and address information

Nataly Rodríguez Buglioni
Salas 1541 depto. W13
Concepción, Chile
e-mail: rodriguezbuglioni@gmail.com

Solving of Quantitative Physics Tasks – Selected sub-Skills and How to Teach Them.

Marie Snetinova, Zdenka Koupilova

Department of Physics Education, Faculty of Mathematics and Physics, Charles University in Prague, Czech Republic

Abstract

Solving of quantitative physics tasks is one of the teaching techniques used very often not only at Czech high schools. However, students often face many obstacles when solving physics tasks (Byun et al., 2008). Our previous research focused on students' perception of problem solving process in physics (Snetinova & Koupilova, 2014) shows that equations are the most important aspect of solving quantitative physics tasks for students. Thus, the solving of quantitative tasks often turns into nearly mindless manipulation with the equations and the main aim for students is getting a number as a result of the tasks. Unfortunately, with such an approach, the deeper understanding of the physics context as well as the developing of problem solving skills is disappearing.

For this reason, we prepared seven activities oriented on improvement of students' problem solving skills. Each activity consists of methodical materials for teachers (with activity description independent of particular topic) and examples of worksheets for students that were prepared according to needs of teachers participating in a pilot study. The activities are focused on selected parts of the problem solving process.

In this paper, we present the activity concentrated on creation of a problem solving plan. Participants of our workshop at GIREP-MPTL 2014 Conference had an opportunity to try this activity on their own. Findings gained from the workshop are also discussed in the paper.

Keywords

Problem solving, quantitative physics task, classroom activities

1. Introduction

Solving of quantitative physics tasks is undoubtedly an important part of physics. However, students often face many obstacles when solving physics tasks (Byun et al., 2008). The previous research focused on students' perception of problem solving process in physics (Snetinova & Koupilova, 2014) shows that equations are the most important tool for students when solving quantitative physics tasks. Thus, the solving of quantitative tasks often turns into nearly mindless manipulation with the equations and the main aim for students is getting a number as a result of the tasks. Unfortunately, with such an approach, the deeper understanding of the physics context as well as the developing of problem solving skills is disappearing.

In connection with the previous questionnaire research (Snetinova & Koupilova, 2013; Snetinova & Koupilova, 2014) and results gained from the literature research (e.g. Chi et al., 1981; Harper, 2006; Van Heuvelen, 1991; Whimbey & Lochhead, 1999), we prepared seven activities focused on development of selected parts of the problem solving process (Table 1).

Each activity consists of methodical materials for teachers (with description of the activity independent of a particular topic) and worksheets for students that were prepared according to the needs of teachers participating in the pilot study of the activities and serve as an example how to prepare worksheets for particular lesson. Because a big amount of quantitative physics tasks exists in Czech textbooks and task collections, we decided to use these tasks for students' worksheet activities, instead of creating new tasks.

Methodical materials of all activities are placed on the website

http://kdf.mff.cuni.cz/materialy/problem_solving.php

Development of the activities and structure of the subsequent research were discussed and prepared in cooperation with experts from the Department of Physics Education (Faculty of Mathematics and Physics, Charles University in Prague, Czech Republic) and experienced secondary school physics teachers.

Table 1. List of activities together with a short description

Name of the activity	Description of the activity
<i>Creating own problem solving plan</i>	Group of students create their own plan (or hint list) how to proceed with solving physics tasks.
<i>Solving aloud</i>	Students solve given task aloud to realize each step in the reasoning.
<i>Careful reading</i>	Students are asked to underline parts of task assignment (numeric as well as nonnumeric) significant for solving the tasks.
<i>Conditions of applicability</i>	Students should realize that it is not possible to use each formula in every situation.
<i>Principles needed for solution</i>	In this activity, students select from a list such physics principles that are appropriate for solving the given tasks.
<i>Classifying the equations</i>	Students determine how important assigned equations are and whether it should be memorised. At the same time, the students look for relations between the equations.
<i>Reasonableness of the answers</i>	Students comment on whether the given numerical answers to physics tasks are reasonable or nonsensical.

2. Description of the pilot study of the activities' usability

The exploratory case studies (Yin, 2003) were used to analyse students' and teachers' reactions to the developed activities. The cases were the assigning of the activities in several Czech secondary school classes. Observation and interviews (see Table 2 for the framework of the interviews) were chosen as data collecting methods. On the basis of the students' and teachers' reactions to the activities in the physics lectures and their opinions gained during the interviewing, the usefulness of the activities was extrapolated.

Table 2. Framework of the questions used to interview the teachers and the students**Questions for teachers***General view of the activity:*

- What is your overall impression of the recent lecture where the activity was assigned?
- How much are you satisfied with the students' work during filling out the worksheets?
- How did the students – according to you – react to the activity? Were their reactions typical? Did they work as usual? For negative answers, please explain in what did their reactions differ and how do you understand them.
- Did any problem or difficulty appear during filling out the worksheet? What are these problems?

Usefulness of the activity:

- Do you think that the prepared worksheet (or rather the activity) can be useful to your students? Why? How?
- What would you see as negative in the prepared activity?
- What would you see as positive, if any, in the activity?
- Is there anything you would recommend to be modified in the activity design?

Usability of the activity:

- Do you use any similar activities in your classes?
- Can you imagine that you would use this or a very similar activity in your class more often?

For the sake of completeness:

- Would you like to add any information, your opinion or observation to the recent activity?

Questions for students

- How would you appraise your work during filling out the worksheets?
- Was the assignment of the worksheet understandable to you? Did you know how to work with the worksheet?
- Is there anything you would want to change in the worksheet?
- What did solution of the worksheet bring to you? What did you practise thanks to the worksheet?
- What do you think was the purpose (when preparing the activity) to practise by the worksheet? For practising of what was the worksheet intended?
- Did you practise it?
- Would you want to add any information, your opinion or observation to the recent activity?

The observation was unstructured, and it was realized in the natural environment (Cohen et al., 2000) – as a part of physics lectures. Standardized open-ended interviews (Patton, 1980) were prepared to collect required data (see Table 2). The interviews were carried out with two students and their teacher in each class. They took place after the physics lectures, where the particular activity was carried out. The interviews were audio recorded and analysed afterwards.

3. Results of the pilot study

All the activities were rated very positively by the students and the teachers. The students often mentioned during the interview that they would like to use similar activities (worksheets) more often in the classes. According to the teachers, the prepared activities are helpful for development of students' problem solving skills in physics. Some teachers stated that this type of activities is new for their students. On the other hand, the teachers added that they sometimes integrate similar methods or procedures on which the activities are focused into their classes, but only as a part of common teaching rather than an activity oriented on practising of a concrete part of solving physics tasks.

3.1 Creating own problem solving plan

Many problem solving plans can be found in professional literature (e.g. Bransford & Stein, 1984; Caliskan et al., 2010; Polya, 2004). Actually, these plans describe how expert problem solvers proceed when they solve quantitative physics tasks. If we want students to teach to “think like a physicists” (Van Heuvelen,

1991), it is suitable to show them that these plans exist and it is useful to proceed according to such plans when solving quantitative tasks.

Creating own problem solving plan is an activity that was presented on GIREP-MPTL 2014 Conference and focuses on creation of own problem solving plan. The main aim for participants of this activity (participants of our conference workshop as well as secondary school students in their physics lectures) is to realize that solving of quantitative physics tasks consists of several very important steps and that it is good to follow these steps. The secondary school students also realize what steps they use and they can compare their own problem solving plan with an expert-like one. Moreover, the students can discuss among themselves about the problem solving steps and they can find inspiration in their classmates approach.

3.2 Description of the activity

The activity is suitable for students of all secondary school classes. Nevertheless, it is not suitable for complete beginners. Before using the activity, the students should have some experience not only with the solving of physics tasks but also with the demands that the teacher place on his or her students concerning problem solving.

The time demands are rather high. The activity can be carried out during one lesson if necessary; nevertheless, the suggested time limits must be very strictly kept during the work. The time pressure can badly influence the activity course and results. Additionally, there is a strong possibility of leaving the work unfinished and missing the aim of the activity. For this reason, we recommend to reserve two consecutive lectures (90 minutes) for this activity.

The activity is divided into four phases. Students work on the plan in the first three phases and present their plan in the last phase. The work runs in groups. The students start to work in pairs and groups are joined twice, so they finish their work in groups of eight. In case of another number of students in class, the teacher should adjust the division of the students, so that the final groups contain about six to ten students.

In the first phase, students work in pairs. They write down as many ideas as they can to answer the question “How do I proceed and what do I pay attention to while solving quantitative physics task?” Every single idea should be written on a separate piece of paper.

The second phase is very similar to the first one, except that the students work in tetrads now (two pairs together). They discuss their ideas, group similar ideas together, and they add other ideas that occur to them.

In the third part, the foursome team up and they create octads. In this phase, the students’ main goal is to classify their thoughts, made some structure of them, and most importantly, to create their own problem solving plan on the base of the ideas written on the pieces of paper. The students should represent their plan graphically. For this reason, sheets of a big format paper, felt-tip pens, coloured pencils or crayons and adhesive tapes must be prepared for them.

Presentation of students’ plans takes place in the fourth phase of the activity. The form of the presentation of the results of individual groups can be chosen from several possibilities – short oral presentation, commented tour through plans’ exhibition, etc. During the presentation, students should present their own ideas, acquaint with work of other groups, and compare their own results. Afterwards, teacher shows students one of the “professional” problem solving plans and offer the opportunity to compare their plan with the plan recommended by expert problem solvers.

The teacher can use results of this activity during following standard physics lectures when solving quantitative tasks. He or she can refer to the created students’ problem solving plans and show, which part of the plan (which step) he or she follows this very moment. The teacher can also return to the created plans after a longer period (for example, after half a year) and ask students to remind themselves of the problem solving plans and their individual steps. They can discuss whether students really use some steps or whether some steps can be added with gaining more experience.

3.3 Students’ and teachers’ reactions

The activity called *Creating own problem solving plan* was tested at first grade at a secondary school (students at the age of 15-16). The activity ran for two consecutive lessons (90 minutes in total). The school has a STEM aimed curriculum, for this reason boys predominated among the students (only one girl attends the class). 19 students attended the activity which proceeded according to the above mentioned instructions. The students started their work in pairs or trios, and at the end they created two individual problem solving plans. The activity was led by students’ regular teacher. We only observed the students’ work and

interviewed two students and the teacher after finishing the activity. Mechanics was taught in this class which could partly affect the particular ideas in the created problem solving plans.

Students approached the activity very lively and creatively. Level of their enthusiasm was surprising also for their teacher who did not expect such a positive students' approach. The students enjoyed especially the phase where they made the final problem solving plans.

The students did not obtain any instructions how the final problem solving plan should look like. They chose their own form of graphical representation. They created very interesting and useful plans (see Figure 3), and were also very pleased when they found out their own plans are comparable to the expert-like plans.

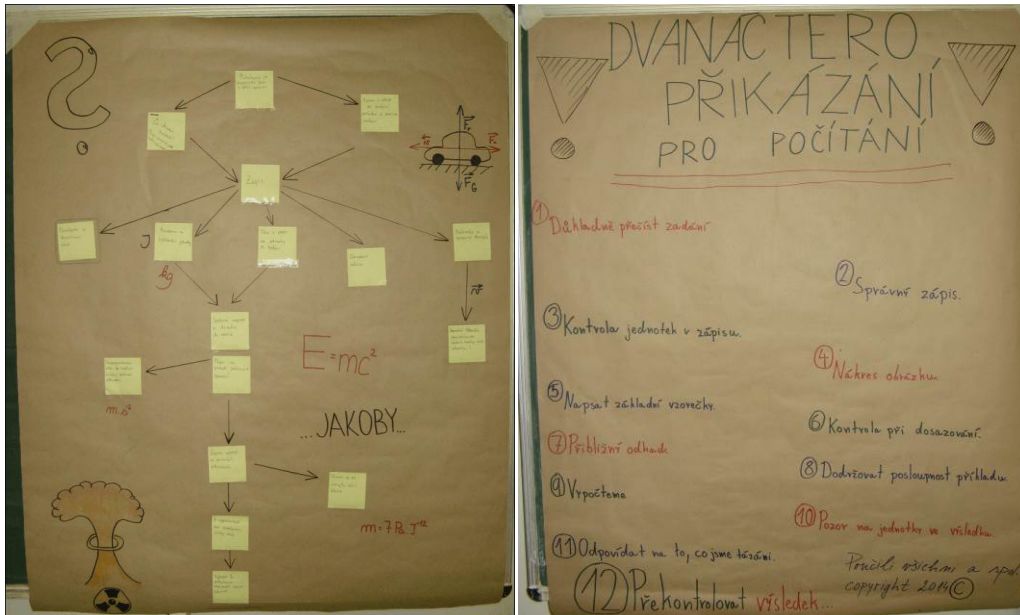

Figure 3. Students' problem solving plan

During the interviews, both interviewed students stated independently that they saw the activity as a useful way of realizing importance of particular steps required during solving physics tasks. They concurred that it can help students to start to use the steps of the problem solving plan they did not use before. The students also viewed the activity to be suitable to realize what they automatically do during solving of physics tasks (see Table 4).

Table 4. Examples of students' answers during the interview

<p>Question How would you appraise your work during creating the problem solving plan?</p> <p>Student 1 “It was great. ... The division (<i>into pairs, tetrads, and octads – authors' note</i>) was good, because we devise something at first, then something else was added to this. One half of it was maybe the same, but several new ideas were added, and our work was gradually completed into more detail. Thus, the ideas stacked up and because of this, we found out many details we didn't have in the beginning.”</p>
<p>Question What do you think was the purpose (when preparing the activity) to practise by creating the problem solving plan? For practising of what was the worksheet intended?</p> <p>Student 1 “To realize what one usually does. Thus, it helped me. And most importantly, a person, who is usually skipping some steps, realizes it and maybe won't skip them next time.”</p> <p>Student 2 “To realize what we should do during solving tasks, to avoid panic, to realize what to do as the first step. When one solves a task, he doesn't realize it very much. He does many things automatically and mainly, he skips some things. But like this, when we can think about this, we realize many things we didn't do before and we could start to do now.”</p>

The teacher's opinion was very similar to the students' answers. According to him, one of the biggest benefits of the activity is that students themselves realize what they should do during solving physics problems and that the plan is not given by any authority. According to the teacher, the problem solving plan can be used in other subjects (e.g. mathematics) with only small modifications.

In teachers' point of view the weakest point of the activity is the time required. He regretted he had to stop some phases of the activity and force students to proceed to following phases. He also mentioned he can see classes that were possible to work on the problem solving plans to good purpose for even longer time than one and a half hour.

4. Workshop at the GIREP-MPTL 2014 Conference

As mentioned above, the activity was also presented on GIREP-MPTL 2014 Conference as a workshop. Participants had the opportunity to create their own problem solving plan exactly in accordance with the rules described above (see Figure 5). Most of the participants were secondary school teachers.



Figure 5. Workshop participants creating their own problem solving plan

All participants were significantly more experienced in solving physics tasks than secondary school students, which affected the created plan. Whereas the students were influenced by the physics topic they went over during creation of the problem solving plan, the participants of the workshop tried to create a plan that would be more general and that would involve all thinkable cases occurring in solving quantitative physics tasks in all physics topics.

The created plan consists of two parts – general and particular problem solving steps. The general problem solving steps that are suitable for all physics tasks and all solvers form the midstream of the plan. The particular specifics are placed on the sides of the plan. We can state a note from one workshop participant from Malta as an illustration of the particular step: *In Maltese case, translate to Maltese* (English is the primary language of instruction in secondary education in Malta).

The problem solving plan also contained arrows connecting the notes and problem solving steps (see Figure 6). At the beginning of the creation of the problem solving plan, the arrows represented course of the task solution and they had similar meaning like arrows in flowcharts, where an arrow coming from one symbol and ending at another symbol represents that control passes to the symbol the arrow points to. Nevertheless, the arrows received another meaning during formation of the problem solving plan – they represented also relations and bonds between the problem solving steps at the end of the work.

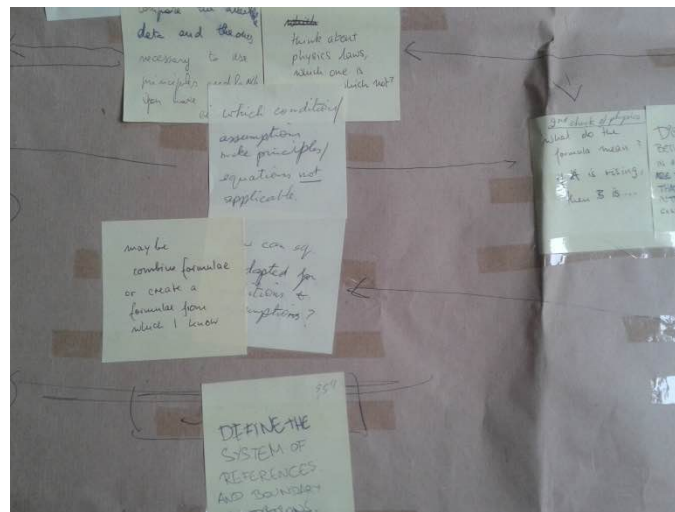

Figure 6. Detailed picture of the problem solving plan

After creating the plan, a discussion about participants' experiences with students' difficulties in solving physics tasks was approached. During the discussion, the participants acquainted each other with their methods how to help students in developing their problem solving skills. For example, one participant mentioned, that she demands to read task assignment with correct intonation and punctuation from their students. This way the teacher tries to help students with better understanding of the assignment. Another example how to improve students' understanding of the problem was to translate or explain "unknown" words from the task assignment.

5. Summary

Seven activities oriented on improvement of students' problem solving skills in physics were developed. The activities are focused on quantitative tasks, especially on creation of general problem solving plan, careful reading, conditions of applicability and principles needed for solutions of some physics tasks, importance of physics formulas, contemplation on reasonableness of answers of physics tasks, and solving physics tasks by thinking aloud.

The pilot study carried out at several Czech secondary schools showed that the concept of the developed activities is perceived very well by students as well as by teachers. The students' positive reactions are for sure partly caused by the fact that the activities were new for them. The students knew that completing the worksheets or working with the activities is not a common part of their classes and their behaviour was also partially influenced by their awareness of being observed. On the other hand, the students stated in the

interviews what is the purpose of the activities according to them, and their answers often agreed with the original intents of the activities.

Findings gained from the pilot study can serve as a good ground for more extensive research focused on investigation of students' skills that those activities developed. Such research would be a logical follow-up to the above described work.

We presented the activity called *Creating own problem solving plan* on the GIREP-MPTL 2014 Conference. Participants had the opportunity to try the role of students and to create their own problem solving plan according to the rules described in the methodical material of the activity. Their work slightly differed from the problem solving plans created by secondary students, because they tried to create a plan that would be usable across all physics topics. The secondary students, on the other hand, were focused on the physics topic they were learning at school at the time when they were creating the problem solving plan.

During the workshop, the participants had also the opportunity to discuss their experiences with students' difficulties in solving physics problems. We believe that the possibility to try to create the problem solving plan as well as the following discussion were inspiring for every participant.

References

- Bransford, J. D. & Stein, B. S. (1984). *The IDEAL Problem Solver: A Guide for Improving Thinking, Learning, and Creativity*. New York: W. H. Freeman.
- Byun, T., Ha, S. and Lee, G. (2008) Identifying student difficulty in problem solving process via the framework of the House Model (HM). *Proceedings of the Physics Education Research Conference*, Vol. 1064, Edmonton, Alberta: AIP, 87-90.
- Caliskan, S., Selcuk, G. S., & Erol, M. (2010). Instruction of Problem Solving Strategies? Effects on Physics Achievement and Self-efficacy Beliefs. *Journal of Baltic Science Education*, **9(1)**, 20-34.
- Chi, M. T. H., Feltovich, P. J., & Glaser, R. (1981). Categorization and Representation of Physics Problems by Experts and Novices. *Cognitive Science*, **5(2)**, 121-152.
- Cohen, L. Manion, L., Morrison, K. (2000). *Research Methods in Education* (5th edition). RoutledgeFalmer.
- Harper, K. (2006). Student Problem-Solving Behaviors. *The Physics Teacher*, **44(4)**, 250-251.
- Patton, M. Q. (1980). *Qualitative Evaluation Methods*. Beverly Hills: Sage Publications.
- Polya, G. (1985). *How to Solve It: A New Aspect of Mathematical Method* (2nd edition). Princeton: Princeton University Press.
- Snetinova, M. and Koupilova, Z. (2013). Problem Solving Strategies in High School Physics Lectures. *Scientia in educatione* **4(1)**, 63-72.
- Snetinova, M. and Koupilova, Z. (2014) Students' Perception of the Problem solving Process in Physics. *ICPE-EPEC 2013 Conference Proceedings*, 1052-1057.
- Van Heuvelen, A. (1991). Learning to think like a physicist: A review of research-based instructional strategies. *American Journal of Physics*, **59(10)**, 891-897.
- Whimbey, A., & Lochhead, J. (1999). *Problem Solving and Comprehension*. New York: Routledge.
- Yin, R. K. (2003). *Case Study Research: Design and Methods* (3rd edition). Thousand Oaks: SAGE Publications.

Affiliation and address information

Marie Snetinova
 Department of Physics Education
 Faculty of Mathematics and Physics
 Charles University in Prague
 V Holesovickach 2
 18000, Prague 8, Czech Republic
 e-mail: marie.snetinova@mff.cuni.cz

Using Role-Playing Game in a Virtual Learning Environment for a New Approach to Physics Classroom Lessons.

Annalisa Terracina, Massimo Mecella.
SAPIENZA Università di Roma, Italia

Abstract

Although the term “digital native” by Prensky is not appreciated by all pedagogical researchers, it perfectly describes the nowadays students that continuously deal with *technology*. Over the last ten years, the way in which education and training are delivered has considerably changed due to the introduction of new technologies. One of them, very promising, is Game-Based Learning. The work proposed in this paper stems from the experience of the last teaching years to students aged 14-15: the physics lessons given using games, competitions and group collaboration are much more effective than the more traditional frontal lessons. In this work, we propose a constructivist approach in which youngsters are called to be the main actors of the learning process and in which a personal construction of their knowledge is a must, starting from their needs and their motivations. Role playing games fit very well these requirements and in order to reinforce this didactic (and non technical) choice we motivate it by referring to the Gardner’s theory of *five entry points* (strictly related to his theory of *multiple intelligences*) with examples of possible role playing game implementations. The approach that we propose in this work combines two fundamental aspects in the state of the art of e-learning panorama (that commonly are not combined): the integration of Intelligent Pedagogical Agents into Virtual Learning Environments.

Keywords

Intelligent Pedagogical Agent, Virtual Learning Environment, Game-Based Learning, role-playing games, classroom practice.

1. Introduction

Over the last ten years, the way in which education and training are delivered has considerably changed. Technology should be a prominent part of the learning process and should be intended as a support for teachers and learners. One new technology that holds considerable promise for helping to engage learners is Game-Based Learning (GBL). The term game is quite ambiguous, which means that researchers, game designers, parents, students, teachers, etc. have a different concept of game; games refer to a lot of different game formats (video games, location-based games, board games, etc.), game genres (strategy games, edutainment game, role playing game, etc.) and game dynamics (competition, exploration, resource management, etc.). To avoid confusion about games in a learning context, game-based learning (or teaching) is often combined (or used as synonymous) with the term “serious games”. We recall here some definitions of serious game and game-enhanced learning (Dyer 2013):

- According to Corti (2006), serious game “is all about leveraging the power of computer games to captivate and engage end-users for a specific purpose, such as to develop new knowledge and skills”;
- Zyda (2005) defines serious games as “a mental contest, played with a computer in accordance with specific rules, that use entertainment to further government or management education, health, public policy and strategic communication objectives”;
- Sande (2006) defines a serious game as “a game in which education (in its various form) is the primary goal, rather than entertainment”.

GBL is a branch of serious games that deals with applications that have specific learning outcomes. Generally, such games are designed in order to balance the subject matter with the game-play and the ability of the player to retain and apply subject matter to the real world. In our work, we can see games as inquiry-based laboratories in which participants are able to imagine, engage with, and reflect upon their experiences. Games are intended as scenarios, according to Hangoj (2013). A scenario directly refers to the dynamic, future oriented models for possible actions that are embedded in game designs. Games are well suited for

developing students' scenario competence, which can be defined as the ability to imagine, enact and reflect upon game-specific choices and their consequences.

Gaming and schooling have developed into two distinct "knowledge traditions" that often rely on opposing validity criteria for determining what counts and what does not count as relevant knowledge. To avoid that dichotomy, GBL should integrate different aspects that are related to the knowledge itself, to pedagogical aspect, to scenario-based and every day practice. On the basis of Hangoj (2013), we adopt the idea that there is a complex translation involved in using games for educational purposes and thus we can see GBL as a dynamic interplay of four knowledge practices, as depicted in Figure 25.

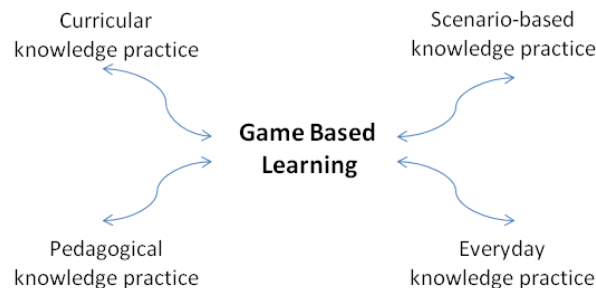

Figure 25: Game based learning as interplay of knowledge practice

In the past years, the rapid growth of the game industry has aroused wide interest, particularly among educational technology researchers as well as digital learning material producers and publishers. It is known that the possibilities to use digital games in education have been considered since the 70s. Nevertheless, the concrete and scientific ambitions to produce high quality educational games have been quite minor (Katamo 2013). Actually, the quality of produced games has not met the expectations of educators and the use of games has not become as general as expected. However, the rapid growth of the entertainment game market has reawakened the interest of educational researchers and producers, and game studies have rapidly developed into an important interdisciplinary research field as well as a nascent academic discipline. So, it seems that games will get another chance to prove their usefulness in computer-assisted learning (Katamo 2013).

In this context, our work aims at developing a game in order to teach STEM subjects, in particular physics. The game that we are designing and going to develop takes into account all the aspects of GBL previously introduced. In addition, and more importantly, we try to integrate the most up-to-date technologies in this field like *Virtual Learning Environments* (VLEs, which add value to the educational process by giving new possibilities and computational-richness support) and *Intelligent Pedagogical Agents* (IPAs, which provide personalized instructions, increase learner motivation, and act pedagogically on behalf of the learner). In this work, we propose that each student has her own IPA (on her own personal device) that guides her throughout the role-playing game. The recent use of 3D immersive VLEs has shown effectiveness in improving the motivation towards learning; therefore we propose it as storyboard for the role playing game.

2. State of the art

2.1 Intelligent Pedagogical Agent

The first grand challenge of Artificial Intelligence (AI) in education, as suggested by Woolf (2013), is *mentors for every learner*. This focuses on applying the finding of learning science to the design and building of systems that can interact with learners in natural ways and act as mentors to individuals and collaborative groups when a teacher is not available.

The concept of Intelligent Pedagogical Agent can be described as (Soliman 2010):

- *Agent*. The agent is a software component that can act by itself in the environment based on a goal.
- *Intelligent*. An intelligent agent applies distributed AI methods to achieve goals. Intelligence can be characterized as the agent's ability to learn from the environment and change the behavior accordingly to achieve the design goals.
- *Pedagogical*. In this context, the intelligent agent should possess pedagogical abilities to achieve educational objectives.

In our work, the relation between the student and her IPA should progress all along two paths: the learning aspect (giving tips and advices related to the topics and to the assigned tasks) and the emotional/pedagogy one (giving advices depending on the feelings of the student).

Emotions are important for students in two major ways. First, emotions have an impact on learning. They influence our ability to process information and to accurately understand what we encounter. For these reasons, it is important for teachers to create a positive, emotionally safe environment to provide for the optimal learning of students. Second, learning how to manage feelings and relationships constitutes a kind of “emotional intelligence” that enables people to be successful (Darling-Hammond 2014).

Some researchers focus their attention on making educational games more pedagogically effective by making them capable of providing interactions tailored to each student’s needs and targeted at stimulating learning when necessary. These systems are named Intelligent Tutoring Systems (ITSs). Here we focus on ITSs that are developed as agents and we disregard ITSs that have different forms. Although there is well-established research on building student-adaptive computer based educational tools, still a few research activities have focused on electronic educational games. In the approach followed by Conati (2004) there are two main challenges, namely (i) in educational games it is especially difficult to assess students’ knowledge and learning from the interaction with the game, because often game actions do not have a direct connection with a student’s understanding of the underlying domain; and (ii) how to provide individualized interventions that trigger learning, without interfering with the high level of engagement that educational games usually trigger precisely because they do not remind students of traditional educational activities. The game used in the study by Conati is Prime Climb that is an educational game devised by the EGEMS (Electronic Games for Education In Math and Science) group at the University of British Columbia.

Mori (2013) presents a natural language communication system that has been developed to support effective communication without disrupting the player flow experience while gaming. In most cases the in-game dialogues consist in the ability of the player to choose one sentence among a limited set of sentences that were prescript by the game author. The system proposed by Mori conversely allows the player to express himself in natural language. Systems that use natural language algorithms are typically referred as Dialogue Management Systems (DMSs). They exploit the automatic management of dialogues between the user and the computer controlled Non-Player Characters (NPCs), which are the characters controlled by the system itself. The system processes users’ input sentences and returns the best answer among a set of possible answers stored in the NPCs’ knowledge base.

2.2 Virtual Learning Environment

According to Dillenbourg (2000), a Virtual Learning Environment (VLE) must comply with some specific rules:

1. A VLE is a designed information space. For learning environments, the functional requirements are numerous and have not been yet systematically studied. Anyhow here are a few examples: Using information in educational interactions; Multi-authoring; Indicating information source; Maintaining information; Following technical evolution; Sharing information with the world.
2. A VLE is a social space. What is specific to virtual environments compared to any information space is that it is populated. The users are inside the information space and see a representation of themselves and/or others in the space. As soon as students see who else is interested by which information, the space becomes inherently social.
3. The virtual space is explicitly represented. The representation of the learning environment ranges from text-based interfaces to the most complex 3D graphical output. The key issue is not the representation per se, but what the students actually do with this representation.
4. Students are not only active, but also actors. The notion of a learning activity in VLEs refers to something richer than in individual courseware, closer to the notion of project. The difference between other constructivist environments and what virtual environments potentially are can be described as making students not only active, but also actors, i.e. members and contributors of the social and information space.
5. VLEs are not restricted to distance education. The use of VLEs can influence the way teachers teach and thereby contribute to renew teaching methods in classroom practice.
6. VLEs integrate multiple tools. A physical learning environment generally integrates courses, resources (libraries), formal communication (boards) and informal communication (cafeteria), an administration, etc. Similarly, a VLE integrates a variety of tools supporting multiple functions: information,

communication, collaboration, learning and management. The idea of environment includes this notion of integration.

7. Most virtual environments overlap with physical environments. VLEs do not only integrate a variety of software tools but also integrate all the physical tools that can be found in a classroom.

In order to further assess added pedagogical values of VLEs, we can compare with ITSs; in ITSs, the main characteristic is the removal of human intervention by the use of AI methods. Whereas ITSs are intended to provide pedagogical functions through personalization, sequencing, and others, their direct benefits are a focus on individual uses as direct consequences of the removal of the human tutor. But so far, they lacked the rich 3D visualization aspects that are available in recent 3D VLEs. Furthermore, a VLE provides more collaboration and exploration-based learning opportunities and can be much more open and flexible than the individualistic ITS.

3. The game

Our main proposal is a VLE that in turn is a role-playing game. The role-playing game is a social game in which each student becomes a player with her abilities and her tasks. In addition, a designated student becomes the master, who is the coordinator of the activities and tasks of her team. In order to success, all the players should work to obtain a common objective and a common goal. The success of the single individual coincides with the success of the entire community (the class). The storyboard is designed in a way that there is an evolution in the role-playing game and a progress in the level of learning as well.

Table 19: Gardner’ s theory of five entry points and role-playing game

Howard Gardner Five Entry Points	Why role playing game	Examples (based on the same storyboard)
<i>Narration entry point (read or tell a story)</i>	The VLE in the game coincides with a plot (<i>tell a story</i>) that evolves during the game	Conquer an exoplanet and colonize it
<i>Logical-quantitative entry point (provide data, use deductive reasoning, examine numbers, narrative plot structure, cause and effect relationship)</i>	During the game, students should <i>solve problems and specific assigned task</i> .	Form a team and solve the following single task: (a) how long the journey will last; (b) how much fuel is needed; (c) gravity on the new planet (i.e., the exoplanet)
<i>Philosophical entry point (big questions about reasoning and the way of reasoning)</i>	Students should consider pros and cons of every possible solution. They should discuss all together and <i>understand the implications of their choices</i> .	Evaluate the consequences of colonizing a planet: (a) what to do if the planet is already inhabited; (b) how to protect the local environment
<i>Aesthetic entry point (emphasize sensory, activate aesthetic sensitivities)</i>	The information/social space is explicitly represented as a 3D immersive world	The 3D immersive world can be partially customized and students can choose the preferred configuration
<i>Experimental entry point (hands-on-approach, dealing directly with materials, simulation, personal explanations)</i>	The game requires that students take actively part in the story by solving problems and finding solutions. The team discussion is also a must.	Simulate a different gravity on the new planet and: (a) discover which force we need to lift a stone; (b) how heavy we are

“Role-playing games offer people the chance to actively take part in their own alternate expressions of identity, exploring parts of themselves that were previously submerged or repressed by the dominant culture and the requirements of daily roles. Role-playing games exist in many forms, from virtual role-playing to tabletop to ‘live action’. While each type of role-playing offers a unique experience, these games provide a compelling escape from the mundane reality, attracting millions of players worldwide. Unlike the passive experience of watching a film or reading a book, these games encourage players to actively take part in the adventure, sometimes even developing their own stories and characters. RPGs also offer a safe, relatively consequence-free space where players can develop certain aspects of themselves. Through role-playing,

players learn how to inhabit the headspace of someone other than their primary ego identity, offering them the chance to develop a stronger sense of empathy. RPGs help encourage a sense of community, by teaching individuals to function as a group. Experiences transpiring in RPGs allow players to develop a deeper understanding about themselves and one another during the course of the adventure.” (Bowman 2010)

Another important aspect is Gardner theory of multiple intelligence and, in particular, his theory of entry points (Gardner 1999): “My own belief is that any reach, nourishing topic - any concept worth teaching - can be approached in at last five different ways that roughly speaking map onto the multiple intelligence. We might think of the topic as a room with at least five doors or entry points into it. Students vary as to which entry point is most appropriate for them and which routes are most comfortable to follow once they have gained initial access to the room. Awareness of these entry points can help the teacher introduce new materials in ways in which they can be easily grasped by a range of students; then, as students explore other entry points, they have the chance to develop those multiple perspectives that are the best antidote to stereotypical thinking”.

Combining such aspects, we elaborated Table 1 in which we reports the five entry points theorized by Gardner and, for each one of them, we give a possible link with the adoption of a role-playing game (second column). In the third column, a concrete example of a possible actuation is given. In the above scenario, it is expected that the students have great flexibility, faced with numerous learning opportunities and therefore require intelligent support and guidance. The use of IPAs is proposed as support during the game evolution: they act as learning facilitators and guide the learners in the virtual environment, by explaining topics, answering questions, giving feedbacks, helping the learners to collaborate with others, providing personalized learning support.

3.1 Use case scenario

As shown in Figure 26, the teacher introduces the scenario and explains to the students the problems that they have to solve during the game. Each problem is formed by several tasks. After that, the teacher designates a master. The master is a key role for several reasons; from a pedagogy point of view, the master behaves at the same level of the teacher and this match Chan and Baskin approach in which a student can “learn how to learn by teaching”; from a learning point of view, the master learns not only the involved topics, but also the best strategy to be adopted for an optimal solution. In each session of the game, the master should be a different student, so everyone can experience a role of major responsibility. Then, the master with the help of the teacher, can form teams and assign a specific role to each student. The student, from now on, becomes a player with her specific role and her own task as well (depending on the level of the student). In this phase, an IPA is assigned to each student/player. Therefore the student has her virtual tutor that will drive her all along the game. The relation between the student and her IPA should progress all along two paths: the learning aspect (giving tips and advices related to the topics and to the tasks assigned) and the emotional/pedagogy one (giving advices depending on the feelings of the student). Each student is assigned a task to be solved. Each task is part of a more general problem and each single contribution permits to solve the more general complex problem. The student should solve the task possibly by her own at home (homework) or during classroom lessons, depending on how the teacher would like to organize the work. The player is invited to share her solution with the others. Team discussion is useful in order to succeed in the problem solution and will help the class to cooperate and collaborate. The teacher can intervene on specific topics related to the problem solution, and can help the master, if necessary, to coordinate the discussion. When the team achieves a solution, the master can verify it, and if the provided solution is fine, the game proceeds to the next level. Before affording the next problem, the students can play and construct pieces of the scenario, useful for the storyboard to continue.

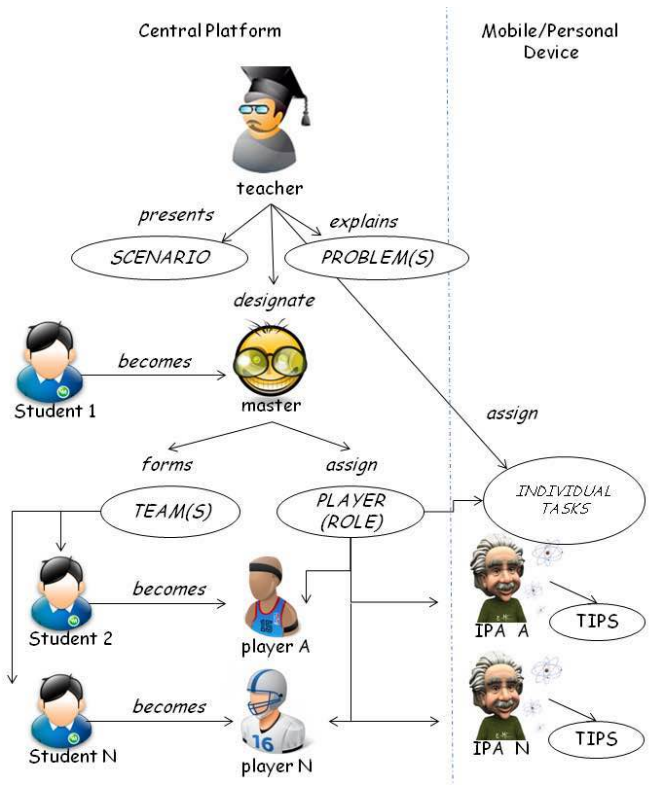

Figure 26: Actors involved, their roles and the actions to initiate the game

3.2 System Architecture

Figure 27 shows the three main components that run on the central platform, namely the Game Engine (GE), the Intelligent Pedagogical Engine (IPE), and the Teacher Workplace (TW). For each student/player, there are the corresponding components on her personal device, namely the Game Individual Task Handler (GITH), the IPA and the Student Workplace (SW). VLE and devices are connected through the Internet.

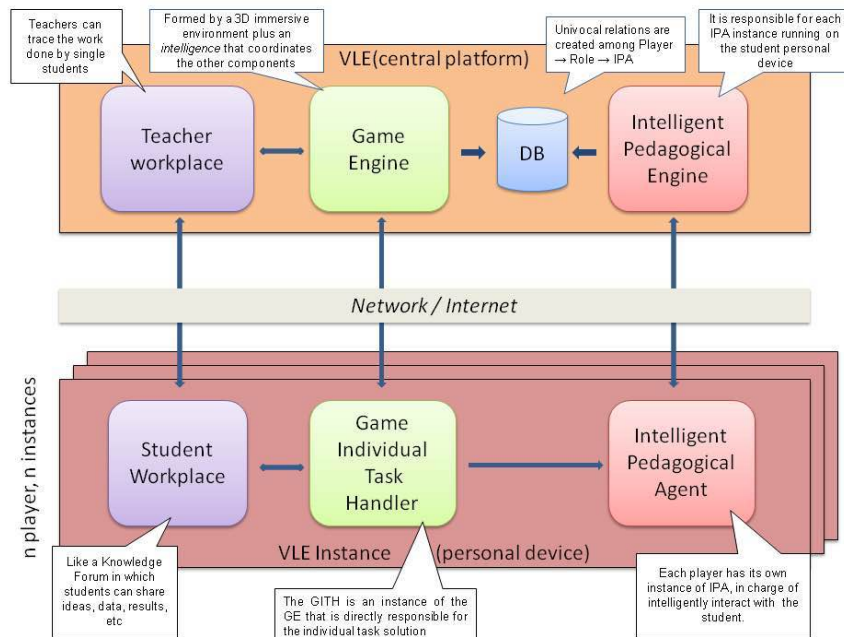

Figure 27: Role-Playing Game Architecture

Game Engine component. The GE component is formed by the 3D immersive environment plus the intelligence that coordinates the other components of the system. In particular the GE will be responsible for:

- *Managing the players and the assigned tasks.* Each player as a role and depending on the role a specific task is assigned. A task can be seen as a problem to be solved from a teaching point of view and as an objective to achieve from the gaming point of view.
- *Interacting with the teacher's workplace.* The game engine should send logs about the player activity to the teacher's workplace.
- *Communicating with the DB.* Once a univocal relation is created:

$$\text{Player} \rightarrow \text{Role} \rightarrow \text{IPA} \rightarrow \text{Tips}$$
the GE should be able to retrieve the correct information for the single player during the game evolution.
- *Instantiating the individual task.* A single task for each player should be created as an instance and sent to the GIT component.

IPE component. The IPE is responsible for each IPA instance running on the student personal device. This component is in contact with the DB in order to retrieve the correct tips for each player. All the Agents possible replies are registered in a database linked to a school situation and a possible reaction of the virtual tutor (namely a facial expression and a motivational phrase, that is not verbal but that is a preregistered animated avatar). The students interact with the IPA via chat expressing their feeling in natural language. Natural language analysis is then performed on students phrase to detect if their emotion is positive, negative or neutral. Then, the tutor will give the best answer to the student. The best possible answer, consist of the combination of different information:

- Detection of school situation via the game scenario
- Natural language analysis of student phrases.
- Classification of student in positive and negative faces.

The combination of these factors according to a specific algorithm determines the possible best answer.

Teacher's Workplace component. The teacher's workplace is a virtual environment in which there is a matching between the student and her role in the game. Teachers can trace the work done by the single student looking at how long the student played the game, the individual solution to the assigned task, how many tips was asked, how was the relation with the IPA, etc. This component is accessible to the teacher and there are only information strictly related to the game activity.

Game Individual Task component. Each student/player has assigned an individual task, that is the reason why on the personal device the student has the GIT component. While the central platform controls the entire game via the GE, the GIT is an instance of the GE that is directly responsible for the individual task solution.

Intelligent Pedagogical Agent component. On the personal device we have the IPA that directly talk to the central component, the IPE. The IPA ask to the IPE not only tips related to the individual task solution but also what concern the intelligent behavior of the agent.

Student workplace component. The student workplace should be intended as a sort of Knowledge Forum that provides students and teachers with a collaborative space in which to share ideas and data about the game, analyze individual results, discuss questions, cite reference material, etc. The student workplace and the teacher workplace are strongly bound since the teacher can intervene; act as a moderator and monitor student activity.

4. Conclusion

Nowadays, we deal with digital native students, and therefore we need to follow them on their digital requirements; on the other side, learning remains a slow process that requires curiosity, devotion and time to absorb and elaborate information. From a pedagogical point of view, a role-playing game, even if using a virtual learning environment, provides enough time to elaborate and think to problems and solutions. In addition, it gives a key role to collaboration and cooperation that sometimes in schools are not sufficiently considered, limiting solely to individual results.

To the best of our knowledge, currently it does not exist a serious game integrating Virtual Learning Environments and Intelligent Pedagogical Agents, therefore this is an initial innovative point of our research. Moreover, so far the efforts in e-learning and serious games have been mainly focused on kids or to University students; the high school case is quite never considered, whereas there is an increasing interest in teaching STEM subjects in a different way in high schools. Finally, the majority of the e-learning systems are intended for distance teaching or used una tantum (like games), whereas the aim of the project is to change the classroom practice by using the developed game as a teaching tool (the same as an e-book). The

majority of the existing serious games are not specifically designed, but are re-adaptations of existing games, or even worst, commercial games are used to teach STEM subjects. Thus, we argue that the outcome of the project will be a serious game prototype that integrates new teaching trends and paradigms making use of the most advanced technologies. The prototype is currently under development, and the approach will be evaluated by experimentally using it in classes, especially for teaching STEM disciplines (physics in particular).

References

- Bowman S. L. (2010), *The Functions of Role-Playing Games: How Participants Create Community, Solve Problems and Explore Identity*. McFarland & Company Inc. Publishers
- Conati C., Zhao X. (2004), Building and evaluating an intelligent pedagogical agent to improve the effectiveness of an educational game. *International Conference on Intelligent User Interfaces*
- Corti K. (2006), Game based business and management skill development. Online (checked 07 Nov. 2014): [http://www.cedma-europe.org/newsletter%20articles/misc/Games-Based_Learning_-_PIXELearning%20\(Feb%2006\).pdf](http://www.cedma-europe.org/newsletter%20articles/misc/Games-Based_Learning_-_PIXELearning%20(Feb%2006).pdf)
- Darling-Hammond L., Orcutt S., Strobel K., Kirsch E., Lit I., Martin D. (2014), *Feelings Count: Emotions and Learning*. Online (accessed 7 November 2014): http://www.learner.org/courses/learningclassroom/support/05_emotions_learning.pdf
- De Freitas et al. (2013), *New pedagogical Approaches in Game Enhanced Learning: Curriculum Integration*. DOI: 10.4018/978-1-4666-3950-8.ch005
- De Freitas S., Maharg P. (2011), *Digital Games and Learning*, Continuum Press.
- Dillenbourg P. (2000). *Virtual Learning Environments*. EUN Conference Proceedings
- Dyer R. (2013), *Games in Higher Education: Opportunities, Expectation, and Challenge of Curriculum Integration*. In De Freitas 2013
- Egenfeldt-Nielsen, S. (2007). *Third Generation Educational Use of Computer Games*. *Journal of Educational Multimedia and Hypermedia*. 16, 3.
- Gardner, H. (1999). *Multiple approaches to understanding*. In Reigeluth C. M. (ed), *Instructional-design theories and models*, vol. 2, pp. 69–89. Mahwah, NJ: Lawrence Erlbaum Associates.
- Hanghoj T (2013), *Game Based Teaching: Practices, Roles, and Pedagogies*. In De Freitas 2013.
- Katamo H., Kiili K., Arnab S., Dunwell I. (2013), *Integrating Games into the classroom: Towards New Teachership*. In De Freitas 2013
- Michael D., Chen S. (2006), *Serious Games: Games that Educate, Train and Inform*. Course Technology Inc., ISBN-13: 978-1592006229
- Mori D., Berta R., De Gloria A., Fiore V., Magnani L. (2013). *An easy to author dialogue management system for serious games*. *Journal on Computing and Cultural Heritage (JOCCH)*, volume 6, issue 2.
- Prensky M. (2001), *Digital Natives, Digital Immigrants*. <http://www.marcprensky.com/writing/Prensky%20-%20Digital%20Natives,%20Digital%20Immigrants%20-%20Part1.pdf>
- Soliman M., Guetl C. (2010), *Intelligent Pedagogical Agents in Immersive Virtual Learning Environments: A Review*. MIPRO 2010 Proceedings
- Wolf B.V., Chad Lane H., Chaudhry V. K., Kolodner J. L. (2013), *AI Grand Challenges for education*. *AI magazine*, winter 2013
- Zyda M. (2006), *From Visual Simulation to Virtual Reality to Games*. In *Computer*, volume 38, issue 9, September 2005, page 25-32

Affiliation and address information

Annalisa Terracina
 Dipartimento di Ingegneria Informatica, Automatica e Gestionale Antonio Ruberti (DIAG)
 SAPIENZA Università di Roma
 Via Ariosto 25, 00185 Roma, Italy
 e-mail: terracina@diag.uniroma1.it

Massimo Mecella

Dipartimento di Ingegneria Informatica, Automatica e Gestionale Antonio Ruberti (DIAG)

SAPIENZA Università di Roma

Via Ariosto 25, 00185 Roma, Italy

e-mail: mecella@diag.uniroma1.it

Motions of a metal ball in three imaginary tunnels through the Earth: A pilot study in Bosnia and Herzegovina on coherence of students' gravitation and inertia conceptions

Jasmina Baluković¹, Josip Sliško²

¹*Prirodno-matematički Fakultet, Univerzitet u Sarajevu, Sarajevo, Bosna i Hercegovina*

²*Facultad de Ciencias Físico Matemáticas, Benemérita Universidad Autónoma de Puebla, Puebla, México*

e-mail: jasminabalukovic@yahoo.com jslisko@fcfm.buap.mx

Abstract

The role of thought experiments in development of scientific knowledge was popular theme in the philosophy of science. Consequently, many physics and science educators were analyzing conceptual meaning and educational potentials of thought experiments, stressing their importance for introducing the nature of science into physics curricula and students' learning of school physics. "The tunnel in the Earth", one of the most creative "destructive thought-experiment", was invented to reveal fundamental weakness of Aristotelian theory of motion. Recently, "the tunnel in the Earth" situation was used again for exploring the gravity conceptions held by children and college students.

The aim of this pilot study was to find out how many students are able to activate the concept of inertia when predicting the motion of a metal ball in three imaginary tunnels bored through the Earth ("horizontal" West – East tunnel, "vertical" North – South tunnel and "inclined" North East – South West tunnel). With two initial positions of the ball on opposite ends of each tunnel, the students' had to predict and conceptually justify six motions, a number sufficient for revealing features of coherent or incoherent conceptions. This aspect of students' conceptions was not studied systematically in previous investigations.

The sample involved 37 junior high school and 57 high school students (mean ages: 14 and 17.5 years, respectively) in two schools in Sarajevo (Bosnia and Herzegovina). 24 students at the junior high school level and 32 students at high-school level provided justifications that made possible to judge their conception of inner-Earth gravitation and activation of the concept of inertia. One junior high-school student and four high-school students predicted correctly that the ball can't stop at the Earth's center and it would perform oscillatory motion in all six cases. Nevertheless, only that one junior high-school student used the concept of inertia explicitly in the justification part. Other students didn't apply the concept of inertia while predicting the motions in the tunnels. Aristotelian-like view that the ball should move toward and stop at the Earth's center was clearly revealed by 3 junior high-school students and 22 high-school students. Seven junior high-school students have shown coherently the conception of gravitational force acting only downwards for "vertical" and "inclined" tunnels. For two cases of "horizontal" tunnel they thought that motion of the metal ball would be affected by the magnetic attraction of the Earth. Such an incoherent approach to conceptualize similar physical situations was detected by other researchers, too.

Keywords

Thought experiments in physics education, tunnel through the Earth, Aristotelian conception of gravity, up-down conception of gravity, understanding of inertia, oscillatory motion

1. Introduction

During the last three decades, the role of thought experiments in development of scientific knowledge was a popular theme in the philosophy of science (Brown, 1991; Sorensen, 1992). Consequently, many physics and

science educators were analyzing conceptual meaning and educational potentials of thought experiments, stressing their importance for introducing the nature of science into physics curricula and students' learning of school physics (*Helm, Gilbert & Watts, 1985; Reiner, 1998; Gilbert & Reiner, 2000; Reiner & Gilbert, 2000; Reiner & Gilbert, 2004; Reiner, 2006; Galili, 2009*). After a careful analysis of many definitions found in the literature, Galili defines a "thought experiment" as "a set of hypothetico-deductive considerations regarding phenomena in the world of real objects, drawing on a certain theory (principle or view) that is used as a reference of validity (Galili, 2009, p. 12).

Velentzas and his collaborators carried out an important work on implementation of "thought experiments" (TE) in physics teaching and learning. They started by revising the presence and the forms of TEs in physics textbooks and trade books dealing with science popularization (Velentzas, Halkia, & Skordoulis, 2007).

Later they were able to show that a few historical TEs have a great potential to make possible learning of different, conceptually-demanding physics topics: elementary quantum theory (Velentzas & Halkia, 2011), satellite physics (Velentzas & Halkia, 2013a) and basic relativity (Velentzas & Halkia, 2013b).

Other researchers have found that TE might be useful as a diagnostic tool in teacher education, too (Asikainen & Hirvonen, 2014).

To complement before mentioned work of Valentzas, Halkia and Skordoulis (2007), we carried out an additional analysis of the presence of historical thought experiments in physics textbooks. That analysis revealed an, until now unreported detail: some textbook descriptions of TEs do not fit the original versions. For instance, Kirkpatrick and Francis (2004), completely falsify Galileo's well-known thought experiment regarding free fall, "describing" it in the following way:

"Imagine dropping three identical objects simultaneously from the same height. The Aristotelians would agree that the three would fall side by side. Now imagine repeating the experiment but with two of objects close to each other. Nothing significant has changed, so there will again be a three-way tie. Finally, consider the situation where the two are touching. Since there was a tie before, there will be no dragging of one on the other, and again there will be a tie. But if the two are touching, they can be considered to be a single object that is twice as big. Consequently, big and small objects fall at the same speed." (Kirkpatrick & Francis, 2004, p. 26).

A similar distorted version of Galileo's thought experiment, with "three bricks" instead of "three identical objects", was introduced in physics teaching by Eric Rogers more than 50 years ago (Rogers, 1960, p. 12). One can understand that authors might change an original thought experiment to make it more convincing to students, but it does not seem correct to falsify historical fact, attributing the changed version to the original author.

2. "The tunnel through the Earth" in physics textbooks and in research on gravity conceptions

Using the terminology of Brown (1991), "the tunnel through the Earth" might be considered as one of the most creative "destructive thought-experiment". It was invented to reveal fundamental weakness of Aristotelian theory of motion. As it is well known, this theory considers that there are two fundamentally different types of motions. The "natural motions" are along vertical towards bodies' "natural places". These "natural places" are determined by bodies' compositions. In the terrestrial realm, the basic elements are "earth", "water", "air" and "fire". Natural motions do not need any force for their executions. A stone, being of "earth nature", falls down because the Earth is its natural place. An air bubble in water goes up because its natural place is above water. Hot air rises seeking highest world layer made of fire.

The "violent motions", in which bodies move in directions different than vertical (e.g. horizontal) or vertically but away of their "natural places", do need an external force to happen. A stone can move upward only if thrown up, by applying an external force.

In an imaginary tunnel, bored through the Earth from Pole to Pole, a heavy body would execute a "natural motion" towards the Earth's center, being the "natural place" of all heavy bodies, where it should stop. If the body doesn't stop there and continues to move up to the Earth's surface, the motion would change abruptly to the "violent motion" away of its "natural place", without action of an external force. This enigmatic change clearly contradicts Aristotelian views on motion. Although the original authorship of this thought experiment is sometimes attributed to Tartaglia and Galileo (*Clement, 2009*), historical evidence shows the experiment was proposed earlier by Nicole Oresme (*Hall, 1978*).

Galileo, in his famous book "Dialogue concerning the two chief world systems – Ptolemaic & Copernican" (Galilei, 1967), grasped that the body in this imaginary tunnel would perform oscillatory motion, gaining

speed from one pole to the Earth center. The grade of gained speed at the center would be enough to reach the other pole in a motion with a decreasing speed. The description of the motion, in Galileo's own words, goes like this:

“...If the terrestrial globe were perforated through the center, a cannon ball descending through the hole would have acquired at the center such an impetus from its speed that it would pass beyond the center and be driven upward through as much space as it had fallen, its velocity beyond the center always diminishing with loses equal to the increments acquired in the descent; and I believe that the time consumed in this second ascending motion would be equal to its time of descent.” (Galilei, 1967, p. 227).

When compared with other Galileo's thought experiments, the thought experiment “The tunnel through the Earth” has rather unfortunate destiny in physics textbooks. The authors don't mention Galileo's authorship and how Galileo used it in an important episode in the history of conceptual development of physics. As we, along with other researchers, will use that though experiment for exploring students' conceptions of gravity and inertia, it is informative to analyze which forms took that thought experiments in physics textbooks. The situation of this thought experiment is commonly used for formulated different types of quantitative physics problems.

1. Type of the motion and the time needed for half of the motion

“Suppose a tunnel could be dug through the earth from one side to the other along a diameter...”

- (a) Show that the motion of a particle dropped into the tunnel is simple harmonic motion. Neglect all frictional forces and assume that the earth has a uniform density...
- (b) If mail were delivered through this chute, how much time would elapse between deposit at one end and delivery at the other end?” (Halliday & Resnick, 1970, Example 2, pp. 257 – 258)

2. The mathematical description of the force

“Assume that a hole is drilled through the center of the Earth... Write down Newton's law of gravitation for an object at a distance r from the center of the Earth, and show that the force on it is of the form of Hooke's law, $F = -kr...$ ” (Serway *et al.*, Problem 65, p. 456)

Some authors even consider motion in an arbitrary tunnel that does not pass through the center of the Earth (Fishbane, Gasiorowicz & Thornton, 2005, Problem 47, p. 382).

Very rarely, authors design tasks that might reveal students' alternative conceptions about motions in such a tunnel. Hewitt formulated a ranking conceptual problem for speed and acceleration for a personal fall through the hole bored completely through the Earth (Hewitt, 2010, Ranking Problem 3, p. 168)

Lang (2008), in her iconoclastic textbook “*Head First Physics*”, uses it as an opening problem to introduce students in active physics learning:

“Suppose you really **are** falling into a bottomless pit that runs from one side of the world to the other. What do you think would happen (assuming that the earth isn't hot and molten inside)? Not sure where to start? That's okay... break it down and go right back to the beginning. **Be a part of the problem!** Ask yourself, “What would I feel just after I step into the tunnel?”” (Lang, 2008, p. 4)

Nussbaum (Nussbaum & Novak, 1976; Nussbaum, 1979) was the first to use task-based interviews about motion of a rock dropped in different imaginary single and double tunnels through the Earth to explore children's ideas about the form of Earth and the nature of its gravity. It was found that conceptual growth of children goes from an absolute, vertical, and downward-acting gravity to a toward-the-center-of-Earth gravity (Nussbaum, 1985).

Recently, “the tunnel through the Earth” situation was used again for exploring the gravity conceptions held by children in China and New Zealand (Blown & Bryce, 2013) and American college students (Asghar & Libarkin, 2010). Such a situation was also a part of pretest and posttest evaluation in a research on the impact of an operational definition of weight concept of students understanding related to different gravitational phenomena (Stein & Galili, 2014).

3. The aim, the instrument and the sample of this pilot study

The aim of this study was to find out how many students are able to activate the concept of inertia when predicting the motion of a metal ball in three imaginary tunnels bored through the Earth (“horizontal” West – East tunnel, “vertical” North – South tunnel and “inclined” North East – South West tunnel). The term “metal ball” was used instead of original Galileo’s term “cannon ball” because students might be confused, knowing that today cannon projectiles are non-spherical shells. Although “stone balls” were firstly used as cannon projectiles, as the artillery was advancing, “iron balls” and “lead balls” were replacing them. The reasons were their bigger density and simpler production technology of casting. In the time of Galileo, metal balls were much more common than stone balls.

With two initial positions of metal ball at opposite ends of each tunnel, the students’ had to predict and justify six motions, a number that is sufficient for revealing a coherent or incoherent conception. It is important to stress that “inertial aspect” of students’ conceptions of body’s motion in the tunnel was not studied systematically in previous investigations.

The students were firstly given a textual and visual description of every one of the mentioned configurations (Figure 1 on the next page). After that, they should describe what would happen to the ball if it were let free at the entrance of the tunnel. They had always the same set of seven choices, from (a) to (g), and were supposed to describe the reasons behind every selected answer (see Box 1).

Box 1. The questions students had to answer for every tunnel-ball configuration. The interchange of the letters A and B is self-understood from the text and the drawing that describe every particular configuration (see **Figure 1**).

If you stop holding the ball, what will happen to the ball? Choose the answer that you find the best.

- (a) It remains in the **point A (B)**.
- (b) It moves to the center of the Earth and it stops there.
- (c) It moves to the center of the Earth and then goes back to the **point A (B)**.
- (d) It moves to the point B (A) and stops there.
- (e) It moves to the point B (A) and then it goes back to the **point A (B)**.
- (f) It moves to the Sun.
- (g) It becomes a satellite of the Earth.

What were the reasons for you to choose this answer?

1a. Imagine that there is a tunnel across the Earth that connects a point on the equator (point A) with another point on the other side of the Earth (point B). You hold a metal ball at the entrance of the tunnel in the **point A (Figure 1a)**. If you stop holding the ball, what will happen to the ball?



Figure 1a. Equatorial tunnel through the Earth with a metal ball hold in the **point A**.

1b. Now imagine that you hold the ball in the **point B (Figure 1b)**. If you stop holding the ball, what will happen to the ball?



Figure 1b. Equatorial tunnel through the Earth with a metal ball hold in the **point B**.

2a. Imagine that there is a tunnel made across the Earth that connects the North Pole (point A) with the South Pole (point B). You hold a metal ball at the entrance of the tunnel in the **point A (Figure 2a)**. If you stop holding the ball, what

2b. Now imagine that you hold the metal ball in the **point B (Figure 2b)**. If you stop holding the ball, what will happen to the ball?





 <p>will happen to the ball?</p> <p>Figure 2a. A tunnel that connects the North and South Pole with a metal ball hold in the point A.</p>	 <p>Figure 2b. A tunnel that connects the North and South pole with a metal ball hold the in the point B.</p>
<p>3a. Imagine that there is a tunnel made across the Earth that is “inclined” with respect to the equatorial plane. You hold a metal ball at the entrance of the tunnel in the point A (Figure 3a). If you stop holding the ball, what will happen to the ball?</p>  <p>Figure 3a. A tunnel across the Earth, “inclined” with respect to the equatorial plane with a metal ball hold in the point A.</p>	<p>3b. Now imagine that you hold the ball is in the point B (Figure 3b). If you stop holding the ball, what will happen to the ball?</p>  <p>Figure 3b. A tunnel across the Earth, “inclined” with respect to the equatorial plane with a metal hold ball in the point B.</p>

Figure 1. Textual and visual description of the six tunnel-metal ball configurations used in this research.

The sample involved 37 junior high-school students and 57 high-school students (mean ages: 14 and 17.5 years, respectively) from two public schools in Sarajevo (Bosnia and Herzegovina). They agreed to participate in the study and answered the questions anonymously. The students also agreed that their expressed views might be used as research data in publications.

Every particular student selected one of possible answer sequences. In other words, there were no students who returned empty research instrument with no selected answers. 24 students at the junior high school level (about 65%) and 32 students at high-school level (about 57%) provided written justifications for their selected answers. Answer options from (a) to (g) can be seen above in Box 1. These justifications made possible to judge their conceptions of gravitation inside the Earth and eventual activation of the concept of inertia. The answer sequences without written justifications were not taken into account. Consequently, these sequences were not analyzed further and are not part of this article.

The basis for categorization of different gravity and inertia conceptions was related to different answer sequences. Four most relevant categories were:

Category1 corresponds to scientific conceptions of gravity and inertia. It is revealed by the answer sequence **(e) (e) (e) (e) (e) (e)**. Students choosing this sequence predict an oscillatory motion of the metal ball for all tunnels and initial positions. They use, explicitly or implicitly, the idea of inertia and know that the ball would not stop at the center of the Earth.

Category 2 corresponds to the gravity conception according to which, in all tunnels and for initial positions, the force of gravity pulls all bodies toward the center of the Earth where they would stop abruptly. It is related to the answer sequence **(b) (b) (b) (b) (b) (b)**. Obviously, students choosing this sequence do not activate the inertia concept according to which moving bodies can't be stopped abruptly. For such an instantaneous change, from motion to rest, an unphysical force of infinite intensity would have to be involved. This category is somehow similar to Aristotelian conception of “natural places” described above.

Category 3 corresponds to the gravity conception according to which, in the vertical and the “inclined” tunnel, the force of gravity acts downward but not upward. The related answer sequence for the pair of questions in the situations 2 and 3 is **(d) (a) (d) (a)**. Those students, who were choosing this sequence, do not activate the concept of inertia because they seem to think that the moving metal sphere would stop abruptly the end of the vertical and the “inclined” tunnel. Their answers **(a)**, for the initial positions at the lower end of the vertical and the “inclined” tunnel, might mean that they used the following reasoning: there is upward gravity force so there will be no motion of the metal ball. That possible reasoning, “no force implies no motion”, is a reverse version of the long known conception “no force implies no motion” (Hestenes, Wells & Swackhamer, 1992; Savinainen & Scott, 2002).

Category 4 corresponds to unclear conceptions of gravity corresponding to apparently incoherent answer sequence.

4. The results of this pilot study

Both researchers identified independently students’ answer sequences and related categories. They also evaluated, in the same way, if the provided written justifications fit the category implied by the answer sequence. The agreement was very high (around 95%). For justification where disagreements appeared, an experienced physics teacher was consulted and her opinion was decisive for getting final agreement.

Category 1

One junior high-school student and four high-school students predicted correctly that the metal ball can’t stop at the Earth’s center and that it would perform oscillatory motion in all six cases. It corresponds to the sequence of answers “**(e)(e) (e)(e) (e)(e)**” (see the **Box 1**). Nevertheless, only in the justification of the junior high-school student the concept of inertia appears explicitly:

“When it goes toward the center it accelerates, after the center it slows down, but due to *inertia* continues to go to B from where the gravitation brings it back.”

High school students gave correct descriptions of the motion, but without mentioning inertia. Here comes one example:

“The ball will accelerate gradually and will reach the maximal velocity when it comes to the Earth's center. From the center it will move slowing down and will reach the minimal velocity in the point B. If we do not act on the metal ball in the point B, it will start to move again and will repeat the procedure.”

All other students didn’t apply the concept of inertia while predicting the motions of the metal ball in the tunnels.

Category 2

Aristotelian-like conception, the ball should go toward and stop at the Earth’s center, was consistently revealed by 3 junior high-school students and 22 high-school students. Their answers formed the sequence “**(b)(b) (b)(b) (b)(b)**” (see the **Box 1**). It should be added that they didn’t speak about ball’s “natural place”, but consider the Earth’s center as the “center of the gravitational force” or the point “where the gravitation is strongest”.

Category 3

Seven junior high-school students have shown coherently the conception of gravitational force that acts only downwards for “vertical” and “inclined” tunnels. Their answers for the questions related to the “vertical” and “inclined” tunnel formed the sequence “**(d)(a) (d)(a)**” (see the **Box 1**). It means that the metal ball can only move “down” and can’t move “up”.

For two cases of “horizontal” tunnel, five of them thought that motion of the metal ball would be affected by the magnetic attraction of the Earth. More precisely, they think that the metal ball should go to and stay at

the Earth's center, corresponding to the answer sequence “(b)(b)” for two first questions (see the **Box 1**). The justification is that the Earth's magnetism is strongest at its center.

This mixed, magnetic-gravitational treatment of ball's motion in six, fundamentally equal, situations is conceptually incoherent. An incoherent students' approach to conceptualize similar physical situations was detected by other researchers, too (*Libarkin & Stokes, 2011*).

Category 4

12 junior high-school students (50%) and 6 high-school students (about 19%) provided very fragmented views on the metal ball motion, depending critically on particular tunnel orientations and initial positions.

5. Conclusions and future research

As it was said above, only one junior high-school student included the concept of inertia in justification why the metal ball can't stop at the Earth's center. Four high-school students who have chosen scientifically correct answer sequence “ee ee ee” (see the **Figure 1**) and described correctly how the velocity of the metal ball changes in the motion through the tunnels didn't activate the concept of inertia. As the concept of inertial was studied before at both educational level, its transfer to the hypothetical situation of “the tunnel through the Earth” didn't happen in almost all involved students.

The majority of students of high-school students (22 out of 32) revealed consistently the conception that in the all six motions of the metal ball, it should stop at the center of the Earth. Their answer sequence was “(b)(b) (b)(b) (b)(b)” (see the **Figure 1**). That conception of Earth's inner gravity corresponds, according to the classification suggested by Nussbaum (1985), to the highest children's notion of the Earth (Notion 5). Some children are able to reach this level of gravity conceptualization at the age of 8 or 9 years (Nussbaum, 1985). Taking into account the mean age the high-school students involved in this research (17.5 years), their results show that almost 8 year of schooling didn't give them enough opportunity to improve their conception of a gravity-influenced motion inside the Earth.

The results of junior high-school students (mean age 14 years) are even more alarming. Only 3 out of 24 students were able to reach the conception that the gravity-induced motion is toward the center of the Earth and should stop there (Notion 5 in Nussbaum's classification gained by children at the age of about 8 or 9 years).

Their conceptions are mainly fragmented, depending on the particular tunnel-ball configurations. The only consistent one, expressed 7 out of 24 students, is that the gravity acts “downward” in the absolute “vertical” direction, independent of the position of the Earth's center

It is important to stress that 5 of 7 of those students for predicting and justifying the motion of the metal ball in the “horizontal” tunnel used magnetic properties of the Earth. It is understandable that students with “vertical gravity” conception are puzzled by the task of predicting the motion in the “horizontal” tunnel. As in such conception the gravity would press the ball “down” to the tunnel's “floor”, a natural choice for them would be (a) “it stays at the point A (B)”. Nevertheless, they switch to the magnetic attraction that is not restricted to the vertical direction and predict that the metal ball should move toward and stop at the Earth's center, corresponding the choice (b).

One might think that this activation of magnetic force (found in thinking of the junior high-school students but in the thinking of the high-school students) was directly caused by expression “metal ball”. As it was already said, we used that expression in order to “translate” the original Galileo's wording “cannon ball” which might sound strange to today's students who generally know that contemporary cannons do not launch ball-like projectiles. In future research, we plan to explore whether the activation of magnetic force in the horizontal tunnels would happen if the expression “stone ball” were used instead of “metal ball”.

In addition, we would like to carry out the future research with a much bigger sample of students and to explore how precisely students apply the concepts of velocity, acceleration and force in hypothetical situations related to “the tunnel through the Earth”. It would be also interesting to know more how students justify the “abrupt stop” of the moving metal (or stone) ball at the Earth's center or at the end of the vertical and “inclined” tunnel.

Acknowledgment The authors sincerely thank to the physicist and electronic-equipment designer and producer Mirjan Petek for his drawing artwork on visual representation of different tunnel-ball configurations used in this research.

References

- Asghar, A., & Libarkin, J. C. (2010). Gravity, magnetism, and "down": Non-physics college students' conceptions of gravity. *Science Educator*, **19**, 42-55.
- Asikainen, M. A., & Hirvonen, P. E. (2014). Probing Pre-and In-service Physics Teachers' Knowledge Using the Double-Slit Thought Experiment. *Science & Education*, **23**(9), 1811-1833.
- Blown, E. J., & Bryce, T. G. K. (2013). Thought-experiments about gravity in the history of science and in research into children's thinking. *Science & Education*, **22**, 419-481.
- Brown, J. (1991). *The Laboratory of the Mind. Thought Experiments in the Natural Sciences*. London: Routledge.
- Clement, J. J. (2009). The role of imagistic simulation in scientific thought experiments. *Topics in Cognitive Science*, **1**, 686-710.
- Fishbane, P. M., Gasiorowicz, S. G. & Thornton, S. T. (2005). *Physics for Scientists and Engineers*. Third Edition. Upper Saddle River, NJ: Pearson/Prentice Hall.
- Galilei, G. (1967). *Dialogue Concerning the Two Chief World Systems – Ptolemaic & Copernican*. Second Edition. Berkeley: University of California Press.
- Galili, I. (2009). Thought experiments: Determining their meaning. *Science & Education*, **18**, 1-23.
- Gilbert, J., & Reiner, M. (2000). Thought experiments in science education: potential and current realization. *International Journal of Science Education*, **22**, 265-283.
- Hall, B. S. (1978). The scholastic pendulum. *Annals of Science*, **35**, 441-462.
- Halliday, D. & Resnick, R. (1970). *Fundamentals of Physics*. New York: John Wiley & Sons.
- Helm H, Gilbert J., & Watts D.M. (1985). Thought experiments and physics education. Part 2. *Physics Education*, **20**, 211-217.
- Hestenes, D., Wells, M., & Swackhamer, G. (1992). Force concept inventory. *The physics teacher*, **30**, 141-158.
- Hewitt, P. G. (2010). *Conceptual Physics*. Eleventh Edition. Boston: Addison-Wesley.
- Kirkpatrick, L. D. & Francis, G. E. (2004). *Physics. A World View*. Fifth Edition. Belmont, CA: Brooks/Cole – Thomson Learning.
- Lang, H. (2008). *Head First Physics. A Learner's companion to mechanics and practical physics*. Beijing: O'Reilly.
- Libarkin, J., & Stokes, A. (2011). The moon has no gravity: examples of idea-mixing in explanations of physical processes. *Planet*, **24**, 50-54.
- Nussbaum, J., & Novak, J. D. (1976). An assessment of children's concepts of the earth utilizing structured interviews. *Science Education*, **60**, 535-550.
- Nussbaum, J. (1979). Children's conceptions of the earth as a cosmic body: A cross age study. *Science Education*, **63**, 83-93.
- Nussbaum, J. (1985) The Earth as a Cosmic Body. In Drive, R., Guesne, E. & Tiberghien, A. (editors) *Children's Ideas in Science* (pp. 170 – 192). Milton Keynes: Open University Press.
- Reiner M. (1998). Thought Experiments and Collaborative Learning in Physics. *International Journal of Science Education*, **20**, 1043-58.
- Reiner, M., & Gilbert, J. (2000). Epistemological resources for thought experimentation in science learning. *International Journal of Science Education*, **22**, 489-506.
- Reiner M., & Gilbert, J. (2004). The symbiotic roles of empirical experimentation and thought experimentation in the learning of physics. *International Journal of Science Education*, **26**, 1819–1834.
- Reiner M. (2006). The Context of Thought Experiments in Physics Learning. *Interchange*, **37**, 97-113.
- Rogers, E. M. (1960). *Physics for the Inquiring Mind. The Methods, Nature, and Philosophy of Physical Science*. Princeton, NJ: Princeton University Press.
- Savinainen, A., & Scott, P. (2002). The Force Concept Inventory: a tool for monitoring student learning. *Physics Education*, **37**, 45 - 52.

- Serway, R. A., Faughn, J. S., Vuille, C. & Bennett, C. A. (2006). *College Physics*. Seventh Edition. Belmont, CA: Thomson Brooks/Cole.
- Sorensen, R. (1992). *Thought Experiments*. New York and London: Oxford University Press.
- Stein, H., & Galili, I. (2014). The impact of an operational definition of the weight concept on students' understanding. *International Journal of Science and Mathematics Education*, 1-29 (published on line).
- Velentzas, A., Halkia, K., & Skordoulis, C. (2007). Thought experiments in the theory of relativity and in quantum mechanics: Their presence in textbooks and in popular science books. *Science & Education*, 16, 353–370.
- Velentzas, A., & Halkia, K. (2011). The 'Heisenberg's Microscope' as an example of using thought experiments in teaching physics theories to students of the upper secondary school. *Research in Science Education*, 41, 525-539.
- Velentzas, A., & Halkia, K. (2013a). From Earth to Heaven: Using 'Newton's Cannon' Thought Experiment for Teaching Satellite Physics. *Science & Education*, 22, 2621-2640.
- Velentzas, A., & Halkia, K. (2013b). The use of thought experiments in teaching physics to upper secondary-level students: Two examples from the theory of relativity. *International Journal of Science Education*, 35, 3026-3049

Affiliation and address information

Jasmina Baluković
Prirodno-matematički Fakultet
Univerzitet u Sarajevu, Sarajevo, Bosna i Hercegovina
e-mail: jasminabalukovic@yahoo.com

Josip Sliško
Facultad de Ciencias Físico Matemáticas,
Benemérita Universidad Autónoma de Puebla, Puebla, México
e-mail: jslisko@fcfm.buap.mx

List of Referees

The Editors gratefully acknowledge the invaluable work voluntarily performed by the referees of the papers presented in this Proceedings Book.

Alex Mazzolini	Silvia Merlino
Onofrio Rosario Battaglia	Marisa Michelini
Eugenio Bertozzi	Vera Montalbano
Assunta Bonanno	Peter Nagy
Giacomo Bozzo	Christiana Nicolaou
Wolfgang Christian	Maria Parappilly
Federico Corni	Alexsandro Pereira
Mojca Čepič	Wim Peeters
Michele D'Anna	Dominique Persano Adorno
Anna De Ambrosis	Roser Pintó
Mieke De Cock	Gesche Pospiech
Nicolas Décamp	David Sokoloff
Leos Dvorak	Dagmara Sokolowska
Margareta Enghag	Ronald Thornton
Sergej Faletic	Ricardo Trumper
Marco Giliberti	Russell Tytler
Enrica Giordano	Ed van den Berg
Raimund Girwidz	Paul van Kampen
Tomasz Greczylo	Stefano Vercellati
Jenaro Guisasola	Kristina Zuza
Claudia Haagen	
Judith Hillier	
Zuzana Ješková	
Maeve Liston	
Sabine Hemmer	
Greg Lancaster	
Matteo Leone	
Olivia Levrini	
Marian Kires	
Alex Mazzolini	

Author Index

- | | |
|---|---------------------------------------|
| Abreu de Oliveira, Marcos Henrique753 | de la Torre, Luis727 |
| Agnes, Corrado149 | De Meester, Jolien1021 |
| Ahmetaga, Shpresa691 | Dehaene, Wim1021 |
| Amoroso, Antonio373 | Devetak, Iztok879 |
| Andrés, Maria Maite775 | Dębowska, Ewa601, 647 |
| Apotheker, Jan175 | Di Paola, Benedetto1029 |
| Aquines, Osvaldo533 | Dimitrova, Vesselina711 |
| Arlego, Marcelo355 | Dormido, Sebastián727 |
| Arpornthip, Tanwa647 | Dvořák, Leoš319, 323, 783, 791 |
| Ascari, Alessandro157 | Dvorakova, Irena791 |
| Bagno, Esther843, 889 | Ekborg, Margareta811, 907 |
| Baluković, Jasmina1105 | Elgue, Mariana225 |
| Barbieri, Sara R165, 759, 923 | Ellermeijer, Ton339, 559, 617 |
| Barčová, Karla609 | Elsholz, Markus795 |
| Barros, Marcelo Alves767 | Evangelista, Rosaria109 |
| Barros, Marina Valentim767 | Eylon, Bat-Sheva843, 889 |
| Battaglia, Onofrio R.1029 | Fagundes, Adriano L.575 |
| Benedetti Roberto347 | Faletič, Sergej421, 429 |
| Beishuizwen, Jos559 | Fanaro, María De Los Angeles225 |
| Bertozzi, Eugenio175, 973 | Fazio, Claudio175 |
| Bianucci, Marco937 | Feldman, Gerald1041 |
| Bollen, Laurens443 | Ferdinande, Hendrik437 |
| Bonanno, Assunta193, 539 | Feijó Barroso, Marta575 |
| Bozzo, Giacomo193, 539, 551 | Fieschi, Roberto937 |
| Böhm, Ulrike843 | Finlayson, Odilla41, 811, 907 |
| Bredeweg, Bert667 | Fischer, Robert753 |
| Brom, Pavel705 | Floriano, Michele A.175 |
| Buitrago, Carlos775 | Fösel, Angela591 |
| Busarello, Gianni399 | Forinash, Kyle583 |
| Carpineti, Marina759, 923 | Fried, Susan795 |
| Carreras, Carmen727 | Frisius, Oliver275 |
| Castells, Marina987 | Fuchs, Hans U.157 |
| Cavalcanti, Cláudio J. H.871 | Fustos, Ivo1079 |
| Ceroni, Gabriele157 | Galano, Silvia233, 897 |
| Cerveró, Josep Maria987 | Galili, Igal5 |
| Chang, Wheijen1011 | Gedigk, Kerstin907 |
| Cheung, Kwok-cheung201 | Geyer, Marie-Annette889 |
| Chittleborough, Gail1049 | Giliberti, Marco165, 759, 923 |
| Colantonio, Arturo399 | Gioka, Olga803 |
| Collazos, Carlos469 | Giordano, Enrica91 |
| Cooper, Rebecca835 | Girwidz, Raimund647, 697, 733 |
| Corni, Federico157 | Gonzalez, Hector533 |
| Constantinou, Constantinos P.667 | Greco, Valeria931 |
| Čepič, Mojca137 | Greczylo, Tomasz601, 647 |
| D'Anna, Michele209, 217 | Grimalt-Alvaro, Carme551 |
| Daniel, Scott461 | Guerra, Francesco979 |
| De Ambrosis, Anna639, 675 | Guisasola, Jenaro443 |
| De Cock, Mieke443, 1021 | Haagen, Claudia241, 249 |
| da Silva Neto, Jader871 | Hadzibegovic, Zalkida257 |
| da Silva, Tatiana575 | Heradio, Rubén727 |

Hernández, María Isabel	281	Martins, Andre F. P.	999
Herrmann, Friedrich	267, 275	Mason, Bruce	647
Hockicko, Peter	453	Mathelitsch, Leopold	591
Holubova, Renata	289	Mazzolini, Alexander	461
Hopf, Martin	241	Mecella, Massimo	1095
Hrabovská, Kamila	609	McLoughlin, Eilish	41, 811, 907
Hubber, Peter	1049	Melder, Trevor	647
Isaeva, Nadezhda	711	Merlino, Silvia	109, 937
Ivanjek, Lana	443	Mészáros, Péter	965
Isaza, Jaime	469	Métioui, Abdeljalil	117, 407
Ješková, Zuzana	559, 617, 811, 907	Miceli, Cristina	367
Job, Georg	217	Michelini, Marisa	523, 647, 853
Káčovský, Petr	297	Montalbano, Vera	347, 863
Kambezidis, Harry	305	Mora, Cesar	469
Kanim, Stephen	443	Moreira, Marco Antonio	47
Kaper, Wolter	339	Mualem, Roni	843
Kaplinsky, Alexander	379	Müller, Andreas	629
Karam, Ricardo	819, 827, 843	Nagy, Péter	657
Kasselouri, Barbara	305	Napoli, Federica	193, 539
Kaselouris, Alexis	305	Nicolaou, Christiana T.	667
Kedzierska, Ewa	559	Ohno, Eizo	1071
Kiryasov Maxim	705	Onorato, Pasquale	639, 675
Kireš, Marián	559, 617, 811, 907	Ostermann, Fernanda	683, 871
Klein, Pascal	629	Otero, María R.	225, 355
Knipprath, Heidi	1021	Otero, Ricardo	469
Kohnle, Antje	29, 647	Ottander, Christina	811, 907
Koníček, Libor	609	Ovcharov Alexey	705
Konstantinidou Aikaterini	987	Pantano, Ornella	129
Koudelkova, Vera	323	Parisoto, Mara Fernanda	753
Koupilová, Zdeňka	319, 1087	Pavlin, Jerneja	137, 879
Krey, Olaf	827, 843	Pažická, Katarína	453
Kuhn, Jochen	629	Pecori, Barbara	175
Kuznetsov, Sergey	705, 711	Pereira de Pereira, Alexsandro	683
Lancaster, Greg	835	Perez, Pablo	533
Langie, Greet	1021	Perez Guerrero Noyola Armando C.	477
Leccia, Silvio	399	Persano Adorno, Dominique	485
Lehavi, Yaron	843, 889	Pintó, Roser	281
Leone, Matteo	979	Pizzolato, Nicola	485
Leong, Tze Kwang	743	Poggi, Valeria	367
Levrini, Olivia	19, 175, 973	Pohlig, Michael	267, 275
Ley Koo, Marcos	493, 955	Pospiech, Gesche	843, 889, 907
Lichtenberger, Andreas	329	Prenjasi, Edlira	691
Liem, Jochem	667	Prodanoff, Fabiana	355
Liston, Maeve	99	Puddu, Emanuella	399
Logman, Paul	339	Puente Leos, Estela M.	493, 955
López, Víctor	551	Ramos Musalem, Karina	955
Lustig, František	705	Rankin, Graham	499
Malgieri, Massimiliano	639, 675	Repnik, Robert	949
Maniaci, Roberta	175	Reston, Enriqueta	515
Mantovani, Carlo	109, 937	Richtberg, Stefan	697
Mäntylä, Terhi	819	Rico, Arantza	83
Mariotti, Emilio	347	Rigon, Enrico	923
Marocchi, Daniela	373, 1059	Rinaudo, Marta	373

Ríos, Raquel	281	Tasquier, Giulia	387
Robotti, Nadia	979	Terracina, Annalisa	1095
Rodríguez Arcos, Marisol	955	Testa, Italo	233, 367, 399, 897
Rodríguez, Nataly	1079	Thaller, Sigrid	591
Rogozin, Konstantin	379, 705, 711	Thielemans, Jan	1021
Rogozina, Irina	711	Thoms, Lars-Jochen	733
Rossi, Sabrina	91	Tran, Trinh-Ba	559, 617
Rovšek, Barbara	949	Trefzger, Thomas	795
Ryder, Jim	999	Trudel, Louis	117, 407
Sáenz, Jacobo	727	van den Berg, Ed	183, 559
Sánchez, Iván	1079	Van Kampen, Paul	443
Sánchez, Juan Pedro	727	Vaterlaus, Andreas	329
Sánchez Sánchez, Rubén	719	Venturi, Margherita	175
Santi, Lorenzo	647	Viennot, Laurence	61
Sapia, Peppino	193, 539	Wagner, Clemens	329
Serio, Marina	1059	Wagner, Jens	591
Sestakova, Jana	383	Wisman, Raymond	583
Shakhvorostova, Darya	379	Wee, Loo Kang	743
Silva, Jorge	647	Wolf, Alexander	379
Slisko, Josip	257, 1105	Yañez Barona, Fernando	477
Smaldone, Luigi	233, 897	Yanyshev, Denis	705, 711
Snetinova, Marie	1087	Yap, Cherile	515
Sokoloff, David	503	Yuste, Manuel	727
Sorokin, Alexey	379	Zanini, Valeria	129
Sorokina, Ekaterina	711	Zappia, Alessandro	233, 897
Spagnolo, Salvatore	931	Zárate Colin, José A.	955
Stefanel, Alberto	853	Zevgolis, Dimitrios	305
Stellato, Marco	923	Zuccarini, Giacomo	523
Švecová, Libuše	609	Zuza, Kristina	443
Talas, Sofia	129		
Tamborini, Marina	923		
Tasnádi, Péter	657		

**Teaching/Learning Physics:
Integrating Research into Practice**

Proceedings of the GIREP-MPTL 2014 International Conference held in Palermo, Italy,
July 7 - 12, 2014

Editors: Claudio Fazio and Rosa Maria Sperandeo Mineo

© Copyright Università degli Studi di Palermo

First edition: 30th June 2015

Dipartimento di Fisica e Chimica, Università degli Studi di Palermo, Palermo (Italy)
ISBN: 978-88-907460-7-9